

Documentation 7.4

ZABBIX

10.01.2025

Contents

Zabbix Manual	5
Copyright notice	5
1 Introduction	5
1 Manual structure	5
2 What is Zabbix	6
3 Zabbix features	6
4 Zabbix overview	7
5 What's new in Zabbix 7.4.0	8
2 Definitions	8
3 Zabbix processes	10
1 Server	10
2 Agent	18
3 Agent 2	21
4 Proxy	24
5 Java gateway	27
6 Sender	31
7 Get	32
8 JS	33
9 Web service	33
4 Installation	33
1 Getting Zabbix	34
2 Requirements	34
3 Installation from sources	44
4 Installation from packages	54
5 Installation from containers	70
6 Web interface installation	79
7 Upgrade procedure	84
8 Known issues	96
9 Template changes	103
10 Upgrade notes for 7.4.0	103
5 Quickstart	103
1 Login and configuring user	104
2 New host	108
3 New item	110
4 New trigger	111
5 Receiving problem notification	113
6 New template	117
6 Zabbix appliance	119
7 Configuration	122
1 Hosts and host groups	131
2 Items	141
3 Triggers	337
4 Events	355
5 Event correlation	358
6 Tagging	364
7 Visualization	367
8 Templates and template groups	391
9 Templates out of the box	391
10 Notifications upon events	402
11 Macros	448

12 Users and user groups	461
13 Storage of secrets	470
14 Scheduled reports	477
15 Data export	480
8 Service monitoring	486
1 Service tree	487
2 SLA	490
3 Setup example	492
9 Web monitoring	496
1 Web monitoring items	505
2 Real-life scenario	506
10 Virtual machine monitoring	513
1 VMware monitoring item keys	515
2 Virtual machine discovery key fields	533
3 JSON examples for VMware items	536
4 VMware monitoring setup example	541
11 Maintenance	546
12 Regular expressions	550
13 Problem acknowledgment	555
1 Problem suppression	558
14 Configuration export/import	559
1 Template groups	560
2 Host groups	561
3 Templates	561
4 Hosts	576
5 Network maps	590
6 Media types	598
15 Discovery	604
1 Network discovery	604
2 Active agent autoregistration	613
3 Low-level discovery	616
16 Distributed monitoring	667
1 Proxies	668
17 Encryption	676
1 Using certificates	683
2 Using pre-shared keys	689
3 Troubleshooting	691
18 Web interface	694
1 Menu	695
2 Frontend sections	702
3 User settings	912
4 Global search	917
5 Frontend maintenance mode	919
6 Page parameters	919
7 Definitions	922
8 Creating your own theme	923
9 Debug mode	923
10 Cookies used by Zabbix	924
11 Time zones	925
12 Resetting password	926
13 Time period selector	926
19 Best practices	927
1 Security best practices	927
2 Configuration best practices	935
20 API	936
Method reference	940
Appendix 1. Reference commentary	1684
Appendix 2. Changes from 7.2 to 7.4	1690
21 Extensions	1690
1 Loadable modules	1692
2 Plugins	1701
3 Frontend modules	1709
22 Appendixes	1710

1 Installation and setup	1710
2 Process configuration	1764
3 Protocols	1836
4 Items	1860
5 Supported functions	1892
6 Macros	1921
7 Unit symbols	1970
8 Time period syntax	1971
9 Command execution	1971
10 Version compatibility	1972
11 Database error handling	1973
12 Zabbix sender dynamic link library for Windows	1973
13 Python library for Zabbix API	1974
14 Service monitoring upgrade	1974
15 Other issues	1975
16 Agent vs agent 2 comparison	1976
17 Escaping examples	1977
23 Quick reference guides	1978
Overview	1978
1 Monitor Linux with Zabbix agent	1978
2 Monitor Windows with Zabbix agent	1982
3 Monitor Apache via HTTP	1985
4 Monitor MySQL with Zabbix agent 2	1989
5 Monitor VMware with Zabbix	1997
6 Monitor network traffic with Zabbix	2000
7 Monitor network traffic using active checks	2003
8 Monitor websites with Browser items	2005
Developer Center	2009
Copyright notice	2010
Modules	2010
Module file structure	2010
Widgets	2018
Tutorials	2026
Examples	2052
Plugins	2052
Examples	2055
Create a plugin (tutorial)	2055
Plugin interfaces	2059
Changes to extension development	2060
Zabbix manpages	2060
zabbix_agent2	2060
NAME	2060
SYNOPSIS	2060
DESCRIPTION	2060
OPTIONS	2061
FILES	2062
SEE ALSO	2062
Index	2062
zabbix_agentd	2062
NAME	2062
SYNOPSIS	2062
DESCRIPTION	2062
OPTIONS	2062
FILES	2063
SEE ALSO	2064
Index	2064
zabbix_get	2064
NAME	2064
SYNOPSIS	2064
DESCRIPTION	2064
OPTIONS	2064
EXAMPLES	2065

SEE ALSO	2066
Index	2066
zabbix_js	2066
NAME	2066
SYNOPSIS	2066
DESCRIPTION	2066
OPTIONS	2066
EXAMPLES	2067
SEE ALSO	2067
Index	2067
zabbix_proxy	2067
NAME	2067
SYNOPSIS	2067
DESCRIPTION	2067
OPTIONS	2068
FILES	2069
SEE ALSO	2069
Index	2069
zabbix_sender	2069
NAME	2069
SYNOPSIS	2069
DESCRIPTION	2070
OPTIONS	2070
EXIT STATUS	2072
EXAMPLES	2072
SEE ALSO	2073
Index	2073
zabbix_server	2073
NAME	2073
SYNOPSIS	2073
DESCRIPTION	2073
OPTIONS	2074
FILES	2075
SEE ALSO	2075
Index	2075
zabbix_web_service	2076
NAME	2076
SYNOPSIS	2076
DESCRIPTION	2076
OPTIONS	2076
FILES	2076
SEE ALSO	2076
Index	2076

Zabbix Manual

Welcome to the user manual for Zabbix software. These pages are created to help users successfully manage their monitoring tasks with Zabbix, from the simple to the more complex ones.

Copyright notice

Zabbix documentation is NOT distributed under the AGPL-3.0 license. Use of Zabbix documentation is subject to the following terms:

You may create a printed copy of this documentation solely for your own personal use. Conversion to other formats is allowed as long as the actual content is not altered or edited in any way. You shall not publish or distribute this documentation in any form or on any media, except if you distribute the documentation in a manner similar to how Zabbix disseminates it (that is, electronically for download on a Zabbix web site) or on a USB or similar medium, provided however that the documentation is disseminated together with the software on the same medium. Any other use, such as any dissemination of printed copies or use of this documentation, in whole or in part, in another publication, requires the prior written consent from an authorized representative of Zabbix. Zabbix reserves any and all rights to this documentation not expressly granted above.

1 Introduction

Please use the sidebar to access content in the Introduction section.

1 Manual structure

Structure

The content of this manual is divided into sections and subsections to provide easy access to particular subjects of interest.

When you navigate to respective sections, make sure that you expand section folders to reveal full content of what is included in subsections and individual pages.

Cross-linking between pages of related content is provided as much as possible to make sure that relevant information is not missed by the users.

Sections

Introduction provides general information about current Zabbix software. Reading this section should equip you with some good reasons to choose Zabbix.

Zabbix definitions explain the terminology used in Zabbix, while **Zabbix processes** provides details on Zabbix components.

Installation and **Quickstart** sections should help you to get started with Zabbix. **Zabbix appliance** is an alternative for getting a quick taster of what it is like to use Zabbix.

Configuration is one of the largest and more important sections in this manual. It contains loads of essential advice about how to set up Zabbix to monitor your environment, from setting up hosts to getting essential data to viewing data to configuring notifications and remote commands to be executed in case of problems.

Service monitoring details how to use Zabbix for a high-level overview of your monitoring environment.

Web monitoring should help you learn how to monitor the availability of web sites.

Virtual machine monitoring presents a how-to for configuring VMware environment monitoring.

Maintenance, **Regular expressions**, **Problem acknowledgment** and **Configuration export/import** are further sections that reveal how to use these various aspects of Zabbix software.

Discovery contains instructions for setting up automatic discovery of network devices, active agents, file systems, network interfaces, etc.

Distributed monitoring deals with the possibilities of using Zabbix in larger and more complex environments.

Encryption helps explaining the possibilities of encrypting communications between Zabbix components.

Web interface contains information specific for using the web interface of Zabbix.

Best practices contain useful tips for optimal and secure user experience.

[API](#) section presents details of working with Zabbix API.

[Extensions](#) is a collection of ways for extending Zabbix.

Detailed lists of technical information are included in [Appendixes](#).

[Quick reference guides](#) contain step-by-step guides for accomplishing tasks with Zabbix.

2 What is Zabbix

Overview

Zabbix was created by Alexei Vladishev, and currently is actively developed and supported by Zabbix SIA.

Zabbix is an enterprise-class open source distributed monitoring solution.

Zabbix is a software that monitors numerous parameters of a network and the health and integrity of servers, virtual machines, applications, services, databases, websites, the cloud and more. Zabbix uses a flexible notification mechanism that allows users to configure email-based alerts for virtually any event. This allows a fast reaction to server problems. Zabbix offers excellent reporting and data visualization features based on the stored data. This makes Zabbix ideal for capacity planning.

Zabbix supports both polling and trapping. All Zabbix reports and statistics, as well as configuration parameters, are accessed through a web-based frontend. A web-based frontend ensures that the status of your network and the health of your servers can be assessed from any location. Properly configured, Zabbix can play an important role in monitoring IT infrastructure. This is equally true for small organizations with a few servers and for large companies with a multitude of servers.

Zabbix is free of cost. Zabbix is written and distributed under the AGPL-3.0 license. It means that its source code is freely distributed and available for the general public.

[Commercial support](#) is available and provided by Zabbix Company and its partners around the world.

Learn more about [Zabbix features](#).

Users of Zabbix

Many organizations of different size around the world rely on Zabbix as a primary monitoring platform.

3 Zabbix features

Overview

Zabbix is a highly integrated network monitoring solution, offering a multiplicity of features in a single package.

Data gathering

- availability and performance checks
- support for SNMP (both trapping and polling), IPMI, JMX, VMware monitoring
- custom checks
- gathering desired data at custom intervals
- performed by server/proxy and by agents

Flexible threshold definitions

- you can define very flexible problem thresholds, called triggers, referencing values from the backend database

Highly configurable alerting

- sending notifications can be customized for the escalation schedule, recipient, media type
- notifications can be made meaningful and helpful using macro variables
- automatic actions include remote commands

Real-time graphing

- monitored items are immediately graphed using the built-in graphing functionality

Web monitoring capabilities

- Zabbix can follow a path of simulated mouse clicks on a web site and check for functionality and response time

Extensive visualization options

- ability to create custom graphs that can combine multiple items into a single view
- network maps
- slideshows in a dashboard-style overview
- reports
- high-level (business) view of monitored resources

Historical data storage

- data stored in a database
- configurable history
- built-in housekeeping procedure

Easy configuration

- add monitored devices as hosts
- hosts are picked up for monitoring, once in the database
- apply templates to monitored devices

Use of templates

- grouping checks in templates
- templates can inherit other templates

Network discovery

- automatic discovery of network devices
- agent autoregistration
- discovery of file systems, network interfaces and SNMP OIDs

Fast web interface

- a web-based frontend in PHP
- accessible from anywhere
- you can click your way through
- audit log

Zabbix API

- Zabbix API provides programmable interface to Zabbix for mass manipulations, third-party software integration and other purposes.

Permissions system

- secure user authentication
- certain users can be limited to certain views

Full featured and easily extensible agent

- deployed on monitoring targets
- can be deployed on both Linux and Windows

Binary daemons

- written in C, for performance and small memory footprint
- easily portable

Ready for complex environments

- remote monitoring made easy by using a Zabbix proxy

4 Zabbix overview

Architecture

Zabbix consists of several major software components. Their responsibilities are outlined below.

Server

Zabbix server is the central component to which agents report availability and integrity information and statistics. The server is the central repository in which all configuration, statistical and operational data are stored.

Database storage

All configuration information as well as the data gathered by Zabbix is stored in a database.

Web interface

For an easy access to Zabbix from anywhere and from any platform, the web-based interface is provided. The interface is part of Zabbix server, and usually (but not necessarily) runs on the same physical machine as the one running the server.

Proxy

Zabbix proxy can collect performance and availability data on behalf of Zabbix server. A proxy is an optional part of Zabbix deployment; however, it may be very beneficial to distribute the load of a single Zabbix server.

Agent

Zabbix agents are deployed on monitoring targets to actively monitor local resources and applications and report the gathered data to Zabbix server. Since Zabbix 4.4, there are two types of agents available: the **Zabbix agent** (lightweight, supported on many platforms, written in C) and the **Zabbix agent 2** (extra-flexible, easily extendable with plugins, written in Go).

Data flow

In addition it is important to take a step back and have a look at the overall data flow within Zabbix. In order to create an item that gathers data you must first create a host. Moving to the other end of the Zabbix spectrum you must first have an item to create a trigger. You must have a trigger to create an action. Thus if you want to receive an alert that your CPU load is too high on *Server X* you must first create a host entry for *Server X* followed by an item for monitoring its CPU, then a trigger which activates if the CPU is too high, followed by an action which sends you an email. While that may seem like a lot of steps, with the use of templating it really isn't. However, due to this design it is possible to create a very flexible setup.

5 What's new in Zabbix 7.4.0

See [breaking changes](#) for this version.

2 Definitions

Overview In this section you can learn the meaning of some terms commonly used in Zabbix.

Definitions **host**

- any physical or virtual device, application, service, or any other logically-related collection of monitored parameters.

host group

- a logical grouping of hosts. Host groups are used when assigning access rights to hosts for different user groups.

item

- a particular piece of data that you want to receive from a host, a metric of data.

value preprocessing

- a transformation of received metric value before saving it to the database.

trigger

- a logical expression that defines a problem threshold and is used to "evaluate" data received in items.

When received data are above the threshold, triggers go from 'Ok' into a 'Problem' state. When received data are below the threshold, triggers stay in/return to an 'Ok' state.

template

- a set of entities (items, triggers, graphs, low-level discovery rules, web scenarios) ready to be applied to one or several hosts.

The job of templates is to speed up the deployment of monitoring tasks on a host; also to make it easier to apply mass changes to monitoring tasks. Templates are linked directly to individual hosts.

template group

- a logical grouping of templates. Template groups are used when assigning access rights to templates for different user groups.

event

- a single occurrence of something that deserves attention such as a trigger changing state or a discovery/agent autoregistration taking place.

event tag

- a pre-defined marker for the event. It may be used in event correlation, permission granulation, etc.

event correlation

- a method of correlating problems to their resolution flexibly and precisely.

For example, you may define that a problem reported by one trigger may be resolved by another trigger, which may even use a different data collection method.

problem

- a trigger that is in "Problem" state.

problem update

- problem management options provided by Zabbix, such as adding comment, acknowledging, changing severity or closing manually.

action

- a predefined means of reacting to an event.

An action consists of operations (e.g. sending a notification) and conditions (*when* the operation is carried out)

escalation

- a custom scenario for executing operations within an action; a sequence of sending notifications/executing remote commands.

media

- a means of delivering notifications; delivery channel.

notification

- a message about some event sent to a user via the chosen media channel.

remote command

- a pre-defined command that is automatically executed on a monitored host upon some condition.

web scenario

- one or several HTTP requests to check the availability of a web site.

frontend

- the web interface provided with Zabbix.

dashboard

- customizable section of the web interface displaying summaries and visualizations of important information in visual units called widgets.

widget

- visual unit displaying information of a certain kind and source (a summary, a map, a graph, the clock, etc.), used in the dashboard.

Zabbix API

- Zabbix API allows you to use the JSON RPC protocol to create, update and fetch Zabbix objects (like hosts, items, graphs and others) or perform any other custom tasks.

Zabbix server

- a central process of Zabbix software that performs monitoring, interacts with Zabbix proxies and agents, calculates triggers, sends notifications; a central repository of data.

Zabbix proxy

- a process that may collect data on behalf of Zabbix server, taking some processing load from the server.

Zabbix agent

- a process deployed on monitoring targets to actively monitor local resources and applications.

Zabbix agent 2

- a new generation of Zabbix agent to actively monitor local resources and applications, allowing to use custom plugins for monitoring.

Attention:

Because Zabbix agent 2 shares much functionality with Zabbix agent, the term "Zabbix agent" in documentation stands for both - Zabbix agent and Zabbix agent 2, if the functional behavior is the same. Zabbix agent 2 is only specifically named where its functionality differs.

encryption

- support of encrypted communications between Zabbix components (server, proxy, agent, zabbix_sender and zabbix_get utilities) using Transport Layer Security (TLS) protocol.

agent autoregistration

- automated process whereby a Zabbix agent itself is registered as a host and started to monitor.

network discovery

- automated discovery of network devices.

low-level discovery

- automated discovery of low-level entities on a particular device (e.g. file systems, network interfaces, etc).

low-level discovery rule

- set of definitions for automated discovery of low-level entities on a device.

item prototype

- a metric with certain parameters as variables, ready for low-level discovery. After low-level discovery the variables are automatically substituted with the real discovered parameters and the metric automatically starts gathering data.

trigger prototype

- a trigger with certain parameters as variables, ready for low-level discovery. After low-level discovery the variables are automatically substituted with the real discovered parameters and the trigger automatically starts evaluating data.

Prototypes of some other Zabbix entities are also in use in low-level discovery - graph prototypes, host prototypes, host group prototypes.

3 Zabbix processes

Please use the sidebar to access content in the Zabbix process section.

1 Server

Overview

Zabbix server is the central process of Zabbix software.

The server performs the polling and trapping of data, it calculates triggers, sends notifications to users. It is the central component to which Zabbix agents and proxies report data on availability and integrity of systems. The server can itself remotely check networked services (such as web servers and mail servers) using simple service checks.

The server is the central repository in which all configuration, statistical and operational data is stored, and it is the entity in Zabbix that will actively alert administrators when problems arise in any of the monitored systems.

The functioning of a basic Zabbix server is broken into three distinct components; they are: Zabbix server, web frontend and database storage.

All of the configuration information for Zabbix is stored in the database, which both the server and the web frontend interact with. For example, when you create a new item using the web frontend (or API) it is added to the items table in the database. Then, about once a minute Zabbix server will query the items table for a list of the items which are active that is then stored in a cache within the Zabbix server. This is why it can take up to two minutes for any changes made in Zabbix frontend to show up in the latest data section.

Running server

If installed as package

Zabbix server runs as a daemon process. The server can be started by executing:

```
systemctl start zabbix-server
```

This will work on most of GNU/Linux systems. On other systems you may need to run:

```
/etc/init.d/zabbix-server start
```

Similarly, for stopping/restarting/viewing status, use the following commands:

```
systemctl stop zabbix-server
systemctl restart zabbix-server
systemctl status zabbix-server
```

Start up manually

If the above does not work you have to start it manually. Find the path to the zabbix_server binary and execute:

```
zabbix_server
```

You can use the following command-line parameters with Zabbix server:

-c --config <file>	path to the configuration file (default is /usr/local/etc/zabbix_server.conf)
-f --foreground	run Zabbix server in foreground
-R --runtime-control <option>	perform administrative functions
-T --test-config	validate configuration file and exit
-h --help	give this help
-V --version	display version number

Examples of running Zabbix server with command-line parameters:

```
zabbix_server -c /usr/local/etc/zabbix_server.conf
zabbix_server --help
zabbix_server -V
```

Runtime control

Runtime control options:

Option	Description	Target
config_cache_reload	Reload configuration cache. Ignored if cache is being currently loaded.	
diaginfo[=<section>]	Gather diagnostic information in the server log file.	historycache - history cache statistics valuecache - value cache statistics preprocessing - preprocessing manager statistics alerting - alert manager statistics lld - LLD manager statistics locks - list of mutexes (is empty on <i>BSD</i> systems) connector - statistics for connectors with the largest queue
ha_status	Log high availability (HA) cluster status.	
ha_remove_node=<target>	Remove the high availability (HA) node specified by its name or ID. Note that active/standby nodes cannot be removed.	target - name or ID of the node (can be obtained by running ha_status)
ha_set_failover_delay=<value>	Set high availability (HA) failover delay. Time suffixes are supported, e.g. 10s, 1m.	
proxy_config_cache_reload[=<target>]	Reload proxy configuration cache.	target - comma-delimited list of proxy names If no target is specified, reload configuration for all proxies
secrets_reload	Reload secrets from Vault.	
service_cache_reload	Reload the service manager cache.	
snmp_cache_reload	Reload SNMP cache, clear the SNMP properties (engine time, engine boots, engine id, credentials) for all hosts.	

Option	Description	Target
housekeeper_execute	Start the housekeeping procedure. Ignored if the housekeeping procedure is currently in progress.	
trigger_housekeeping	Start the trigger housekeeping procedure for services to remove problems caused by triggers that have since been deleted, including service problems generated by such problems (considered as resolved at the time of housekeeping). Note that, until the housekeeping procedure is started, problems caused by now-deleted triggers might still generate service problems and assign them to services. If your setup involves many service status calculation rules based on frequently discovered/undiscovered triggers, consider increasing the frequency of the trigger housekeeping procedure by adjusting the ProblemHousekeepingFrequency server configuration parameter. Ignored if the trigger housekeeping procedure is currently in progress.	
log_level_increase[=<target>]	Increase log level, affects all processes if target is not specified. Not supported on <i>BSD</i> systems.	process type - All processes of specified type (e.g., poller) See all server process types . process type,N - Process type and number (e.g., poller,3) pid - Process identifier (1 to 65535). For larger values specify target as 'process type,N'.
log_level_decrease[=<target>]	Decrease log level, affects all processes if target is not specified. Not supported on <i>BSD</i> systems.	
prof_enable[=<target>]	Enable profiling. Affects all processes if target is not specified. Enabled profiling provides details of all rwlocks/mutexes by function name.	process type - All processes of specified type (e.g. history syncer) Supported process types as profiling targets: alerter, alert manager, availability manager, configuration syncer, discovery manager, escalator, history poller, history syncer, housekeeper, http poller, icmp pinger, ipmi manager, ipmi poller, java poller, lld manager, lld worker, odbc poller, poller, preprocessing manager, preprocessing worker, proxy poller, self-monitoring, service manager, snmp trapper, task manager, timer, trapper, unreachable poller, vmware collector process type,N - Process type and number (e.g., history syncer,1) pid - Process identifier (1 to 65535). For larger values specify target as 'process type,N'. scope - rwlock, mutex, processing can be used with the process type and number (e.g., history syncer,1,processing) or all processes of type (e.g., history syncer,rwlock)

Option	Description	Target
<code>prof_disable[=<target>]</code>	Disable profiling. Affects all processes if target is not specified.	process type - All processes of specified type (e.g. history syncer) Supported process types as profiling targets: see <code>prof_enable</code> process type,N - Process type and number (e.g., history syncer,1) pid - Process identifier (1 to 65535). For larger values specify target as 'process type,N'.

Example of using runtime control to reload the server configuration cache:

```
zabbix_server -c /usr/local/etc/zabbix_server.conf -R config_cache_reload
```

Examples of using runtime control to reload the proxy configuration:

```
# Reload configuration of all proxies:
zabbix_server -R proxy_config_cache_reload
```

```
# Reload configuration of Proxy1 and Proxy2:
zabbix_server -R proxy_config_cache_reload=Proxy1,Proxy2
```

Examples of using runtime control to gather diagnostic information:

```
# Gather all available diagnostic information in the server log file:
zabbix_server -R diaginfo
```

```
# Gather history cache statistics in the server log file:
zabbix_server -R diaginfo=historycache
```

Example of using runtime control to reload the SNMP cache:

```
zabbix_server -R snmp_cache_reload
```

Example of using runtime control to trigger execution of housekeeper:

```
zabbix_server -c /usr/local/etc/zabbix_server.conf -R housekeeper_execute
```

Examples of using runtime control to change log level:

```
# Increase log level of all processes:
zabbix_server -c /usr/local/etc/zabbix_server.conf -R log_level_increase
```

```
# Increase log level of second poller process:
zabbix_server -c /usr/local/etc/zabbix_server.conf -R log_level_increase=poller,2
```

```
# Increase log level of process with PID 1234:
zabbix_server -c /usr/local/etc/zabbix_server.conf -R log_level_increase=1234
```

```
# Decrease log level of all http poller processes:
zabbix_server -c /usr/local/etc/zabbix_server.conf -R log_level_decrease="http poller"
```

Example of setting the HA failover delay to the minimum of 10 seconds:

```
zabbix_server -R ha_set_failover_delay=10s
```

Process user

Zabbix server is designed to run as a non-root user. It will run as whatever non-root user it is started as. So you can run server as any non-root user without any issues.

If you will try to run it as 'root', it will switch to a hardcoded 'zabbix' user, which must be **present** on your system. You can only run server as 'root' if you modify the 'AllowRoot' parameter in the server configuration file accordingly.

If Zabbix server and **agent** are run on the same machine it is recommended to use a different user for running the server than for running the agent. Otherwise, if both are run as the same user, the agent can access the server configuration file and any Admin level user in Zabbix can quite easily retrieve, for example, the database password.

Configuration file

See the **configuration file** options for details on configuring `zabbix_server`.

Start-up scripts

The scripts are used to automatically start/stop Zabbix processes during system's start-up/shutdown. The scripts are located under directory `misc/init.d`.

Server process types and threads

- `agent poller` - asynchronous poller process for passive checks with a worker thread
- `alert manager` - alert queue manager
- `alert syncer` - alert DB writer
- `alerter` - process for sending notifications
- `availability manager` - process for host availability updates
- `configuration syncer` - process for managing in-memory cache of configuration data
- `configuration syncer worker` - process for resolving and synchronizing user macro values in item names
- `connector manager` - manager process for connectors
- `connector worker` - process for handling requests from the connector manager
- `discovery manager` - manager process for discovery of devices
- `discovery worker` - process for handling discovery tasks from the discovery manager
- `escalator` - process for escalation of actions
- `ha manager` - process for managing high availability
- `history poller` - process for handling calculated checks requiring a database connection
- `history syncer` - history DB writer
- `housekeeper` - process for removal of old historical data
- `http agent poller` - asynchronous poller process for HTTP checks with a worker thread
- `http poller` - web monitoring poller
- `icmp pinger` - poller for icmping checks
- `ipmi manager` - IPMI poller manager
- `ipmi poller` - poller for IPMI checks
- `java poller` - poller for Java checks
- `lld manager` - manager process of low-level discovery tasks
- `lld worker` - worker process of low-level discovery tasks
- `odbc poller` - poller for ODBC checks
- `poller` - normal poller for passive checks
- `preprocessing manager` - manager of preprocessing tasks with preprocessing worker threads
- `preprocessing worker` - thread for data preprocessing
- `proxy poller` - poller for passive proxies
- `proxy group manager` - manager of proxy load balancing and high availability
- `report manager` - manager of scheduled report generation tasks
- `report writer` - process for generating scheduled reports
- `self-monitoring` - process for collecting internal server statistics
- `service manager` - process for managing services by receiving information about problems, problem tags, and problem recovery from history syncer, task manager, and alert manager
- `snmp poller` - asynchronous poller process for SNMP checks with a worker thread (`walk[OID]` and `get[OID]` items only)
- `snmp trapper` - trapper for SNMP traps
- `task manager` - process for remote execution of tasks requested by other components (e.g., close problem, acknowledge problem, check item value now, remote command functionality)
- `timer` - timer for processing maintenances
- `trapper` - trapper for active checks, traps, proxy communication
- `trigger housekeeper` - process for removing problems generated by triggers that have been deleted
- `unreachable poller` - poller for unreachable devices
- `vmware collector` - VMware data collector responsible for data gathering from VMware services

The server log file can be used to observe these process types.

Various types of Zabbix server processes can be monitored using the **`zabbix[process,<type>,<mode>,<state>]`** internal `item`.

Supported platforms

Due to the security requirements and mission-critical nature of server operation, UNIX is the only operating system that can consistently deliver the necessary performance, fault tolerance and resilience. Zabbix operates on market leading versions.

Zabbix server is tested on the following platforms:

- Linux
- Solaris
- AIX
- HP-UX

- Mac OS X
- FreeBSD
- OpenBSD
- NetBSD
- SCO Open Server

Note:

Zabbix may work on other Unix-like operating systems as well.

Locale

Note that the server requires a UTF-8 locale so that some textual items can be interpreted correctly. Most modern Unix-like systems have a UTF-8 locale as default, however, there are some systems where that may need to be set specifically.

1 High availability

Overview

High availability (HA) is typically required in critical infrastructures that can afford virtually no downtime. So for any service that may fail there must be a failover option in place to take over should the current service fail.

Zabbix offers a **native** high-availability solution that is easy to set up and does not require any previous HA expertise. Native Zabbix HA may be useful for an extra layer of protection against software/hardware failures of Zabbix server or to have less downtime due to maintenance.

In the Zabbix high availability mode multiple Zabbix servers are run as nodes in a cluster. While one Zabbix server in the cluster is active, others are on standby, ready to take over if necessary.



Switching to Zabbix HA is non-committal. You may switch back to standalone operation at any point.

See also: [Implementation details](#)

Enabling high availability

Starting Zabbix server as cluster node

Two parameters are required in the server [configuration](#) to start a Zabbix server as cluster node:

- **HANodeName** parameter must be specified for each Zabbix server that will be an HA cluster node.

This is a unique node identifier (e.g. `zabbix-node-01`) that the server will be referred to in agent and proxy configurations. If you do not specify `HANodeName`, then the server will be started in standalone mode.

- **NodeAddress** parameter must be specified for each node.

The `NodeAddress` parameter (address:port) will be used by Zabbix frontend to connect to the active server node. `NodeAddress` must match the IP or FQDN name of the respective Zabbix server.

Restart all Zabbix servers after making changes to the configuration files. They will now be started as cluster nodes. The new status of the servers can be seen in [Reports](#) → [System information](#) and also by running:

```
zabbix_server -R ha_status
```

This runtime command will log the current HA cluster status into the Zabbix server log (and to stdout):

```
Failover delay: 60 seconds
Cluster status:
# ID Name Address Status Last Access
1. ckzxxqg7u0001lsropeyhz3m zabbix-node-01 64.227.66.193:10051 standby 0s
2. ckzxyqo1k00013frpq539e1jp zabbix-node-02 64.227.74.25:10051 active 3s
```

Preparing frontend

Make sure that Zabbix server address:port is **not defined** in the frontend configuration (found in conf/zabbix.conf.php of the frontend files directory).

```
// Uncomment and set to desired values to override Zabbix hostname/IP and port.
// $ZBX_SERVER = '';
// $ZBX_SERVER_PORT = '';
```

Zabbix frontend will autodetect the active node by reading settings from the nodes table in Zabbix database. Node address of the active node will be used as the Zabbix server address.

Proxy configuration

HA cluster nodes (servers) must be listed in the configuration of either passive or active Zabbix proxy.

For a passive proxy, the node names must be listed in the Server parameter of the proxy, separated by a **comma**.

```
Server=zabbix-node-01,zabbix-node-02
```

For an active proxy, the node names must be listed in the Server parameter of the proxy, separated by a **semicolon**.

```
Server=zabbix-node-01;zabbix-node-02
```

Agent configuration

HA cluster nodes (servers) must be listed in the configuration of Zabbix agent or Zabbix agent 2.

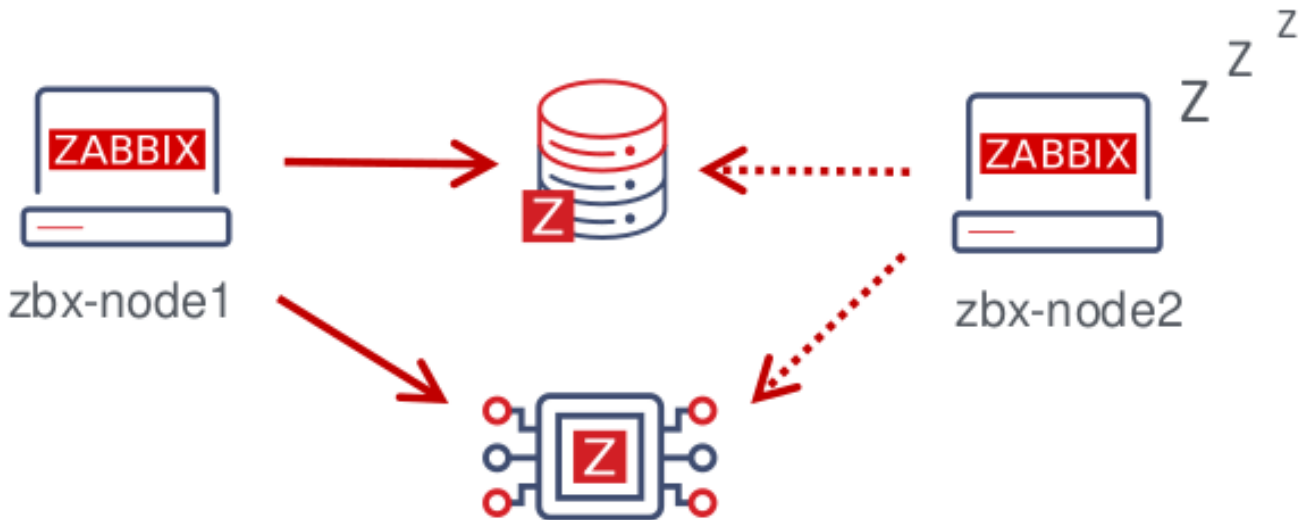

To enable passive checks, the node names must be listed in the Server parameter, separated by a **comma**.

```
Server=zabbix-node-01,zabbix-node-02
```

To enable active checks, the node names must be listed in the ServerActive parameter. Note that for active checks the nodes must be separated by a comma from any other servers, while the nodes themselves must be separated by a **semicolon**, e.g.:

```
ServerActive=zabbix-node-01;zabbix-node-02
```

Failover to standby node

Zabbix will fail over to another node automatically if the active node stops. There must be at least one node in standby status for the failover to happen.

How fast will the failover be? All nodes update their last access time (and status, if it is changed) every 5 seconds. So:

- If the active node shuts down and manages to report its status as "stopped", another node will take over within **5 seconds**.

- If the active node shuts down/becomes unavailable without being able to update its status, standby nodes will wait for the **failover delay** + 5 seconds to take over

The failover delay is configurable, with the supported range between 10 seconds and 15 minutes (one minute by default). To change the failover delay, you may run:

```
zabbix_server -R ha_set_failover_delay=5m
```

Managing HA cluster

The current status of the HA cluster can be managed using the dedicated **runtime control** options:

- `ha_status` - log HA cluster status in the Zabbix server log (and to stdout)
- `ha_remove_node=target` - remove an HA node identified by its <target> - name or ID of the node (name/ID can be obtained from the output of running `ha_status`), e.g.:

```
zabbix_server -R ha_remove_node=zabbix-node-02
```

Note that active/standby nodes cannot be removed.

- `ha_set_failover_delay=delay` - set HA failover delay (between 10 seconds and 15 minutes; time suffixes are supported, e.g. 10s, 1m)

Node status can be monitored:

- in *Reports* → *System information*
- in the *System information* dashboard widget
- using the `ha_status` runtime control option of the server (see above).

The `zabbix[cluster,discovery,nodes]` internal item can be used for node discovery, as it returns a JSON with the high-availability node information.

Disabling HA cluster

To disable a high availability cluster:

- make backup copies of configuration files
- stop standby nodes
- remove the `HANodeName` parameter from the active primary server
- restart the primary server (it will start in standalone mode)

Upgrading HA cluster

To perform a major version upgrade for the HA nodes:

- stop all nodes;
- create a full database backup;
- if the database uses replication make sure that all nodes are in sync and have no issues. Do not upgrade if replication is broken.
- select a single node that will perform database upgrade, change its configuration to standalone mode by commenting out `HANodeName` and **upgrade** it;
- make sure that database upgrade is fully completed (*System information* should display that Zabbix server is running);
- restart the node in HA mode;
- upgrade and start the rest of nodes (it is not required to change them to standalone mode as the database is already upgraded at this point).

In a minor version upgrade it is sufficient to upgrade the first node, make sure it has upgraded and running, and then start upgrade on the next node.

Implementation details

The high availability (HA) cluster is an opt-in solution and it is supported for Zabbix server. The native HA solution is designed to be simple in use, it will work across sites and does not have specific requirements for the databases that Zabbix recognizes. Users are free to use the native Zabbix HA solution, or a third-party HA solution, depending on what best suits the high availability requirements in their environment.

The solution consists of multiple `zabbix_server` instances or nodes. Every node:

- is configured separately
- uses the same database
- may have several modes: active, standby, unavailable, stopped

Only one node can be active (working) at a time. A standby node runs only one process - the HA manager. A standby node does no data collection, processing or other regular server activities; they do not listen on ports; they have minimum database connections.

Both active and standby nodes update their last access time every 5 seconds. Each standby node monitors the last access time of the active node. If the last access time of the active node is over 'failover delay' seconds, the standby node switches itself to be the active node and assigns 'unavailable' status to the previously active node.

The active node monitors its own database connectivity - if it is lost for more than `failover delay-5` seconds, it must stop all processing and switch to standby mode. The active node also monitors the status of the standby nodes - if the last access time of a standby node is over 'failover delay' seconds, the standby node is assigned the 'unavailable' status.

The nodes are designed to be compatible across minor Zabbix versions.

2 Agent

Overview

Zabbix agent is deployed on a monitoring target to actively monitor local resources and applications (hard drives, memory, processor statistics, etc.).

The agent gathers operational information locally and reports data to Zabbix server for further processing. In case of failures (such as a hard disk running full or a crashed service process), Zabbix server can actively alert the administrators of the particular machine that reported the failure.

Zabbix agents are highly efficient because of the use of native system calls for gathering statistical information.

Passive and active checks

Zabbix agents can perform passive and active checks.

In a **passive check** the agent responds to a data request. Zabbix server (or proxy) asks for data, for example, CPU load, and Zabbix agent sends back the result.

Active checks require more complex processing. The agent must first retrieve a list of items from Zabbix server for independent processing. Then it will periodically send new values to the server.

Whether to perform passive or active checks is configured by selecting the respective monitoring **item type**. Zabbix agent processes items of type 'Zabbix agent' or 'Zabbix agent (active)'.

Supported platforms

Pre-compiled Zabbix agent binaries are [available](#) for the supported platforms:

- Windows (all desktop and server versions since XP)
- Linux (also available in [distribution packages](#))
- macOS
- IBM AIX
- FreeBSD
- OpenBSD
- Solaris

It is also possible to download legacy Zabbix agent binaries for [NetBSD](#) and [HP-UX](#), and those are compatible with current Zabbix server/proxy version.

Agent on UNIX-like systems

Zabbix agent on UNIX-like systems is run on the host being monitored.

Installation

See the [package installation](#) section for instructions on how to install Zabbix agent as package.

Alternatively see instructions for [manual installation](#) if you do not want to use packages.

Attention:

In general, 32-bit Zabbix agents will work on 64-bit systems, but may fail in some cases.

If installed as package

Zabbix agent runs as a daemon process. The agent can be started by executing:

```
systemctl start zabbix-agent
```

This will work on most of GNU/Linux systems. On other systems you may need to run:

```
/etc/init.d/zabbix-agent start
```

Similarly, for stopping/restarting/viewing status of Zabbix agent, use the following commands:

```
systemctl stop zabbix-agent
systemctl restart zabbix-agent
systemctl status zabbix-agent
```

Start up manually

If the above does not work you have to start it manually. Find the path to the zabbix_agentd binary and execute:

```
zabbix_agentd
```

Agent on Windows systems

Zabbix agent on Windows runs as a Windows service.

Preparation

Zabbix agent is distributed as a zip archive. After you download the archive you need to unpack it. Choose any folder to store Zabbix agent and the configuration file, e. g.

```
C:\zabbix
```

Copy bin\zabbix_agentd.exe and conf\zabbix_agentd.conf files to c:\zabbix.

Edit the c:\zabbix\zabbix_agentd.conf file to your needs, making sure to specify a correct "Hostname" parameter.

Installation

After this is done use the following command to install Zabbix agent as Windows service:

```
C:\> c:\zabbix\zabbix_agentd.exe -c c:\zabbix\zabbix_agentd.conf -i
```

Now you should be able to configure "Zabbix agent" service normally as any other Windows service.

See [more details](#) on installing and running Zabbix agent on Windows.

Options

It is possible to run multiple instances of the agent on a host. A single instance can use the default configuration file or a configuration file specified in the command line. In case of multiple instances each agent instance must have its own configuration file (one of the instances can use the default configuration file).

The following command-line parameters can be used with Zabbix agent:

Parameter	Description
UNIX and Windows agent	
-c --config <config-file>	Path to the configuration file. You may use this option to specify a configuration file that is not the default one. On UNIX, default is /usr/local/etc/zabbix_agentd.conf or as set by compile-time variables --sysconfdir or --prefix On Windows, default is C:\Program Files\Zabbix Agent\zabbix_agentd.conf
-f --foreground	Run Zabbix agent in foreground (default: true).
-p --print	Print known items and exit. <i>Note:</i> To return user parameter results as well, you must specify the configuration file (if it is not in the default location).
-t --test <item key>	Test specified item and exit. <i>Note:</i> To return user parameter results as well, you must specify the configuration file (if it is not in the default location).
-T --test-config	Validate configuration file and exit.
-h --help	Display help information.
-V --version	Display version number.
UNIX agent only	
-R --runtime-control <option>	Perform administrative functions. See runtime control .
Windows agent only	
-m --multiple-agents	Use multiple agent instances (with -i, -d, -s, -x options). To distinguish service names of instances, each service name will include the Hostname value from the specified configuration file.

Parameter	Description
-S --startup-type <value>	Set the startup type of the Zabbix Windows agent service. Allowed values: automatic - (<i>default</i>) start the service automatically at Windows startup; delayed - delay starting the service after the automatically started services have completed startup (available on Windows Server 2008/Vista and later versions); manual - start the service manually (by a user or application); disabled - disable the service, so that it cannot be started by a user or application. You may use this option together with the -i option, or separately to modify the startup type of an already installed service.
-i --install	Install Zabbix Windows agent as service.
-d --uninstall	Uninstall Zabbix Windows agent service.
-s --start	Start Zabbix Windows agent service.
-x --stop	Stop Zabbix Windows agent service.

Specific **examples** of using command-line parameters:

- printing all built-in agent items with values
- testing a user parameter with "mysql.ping" key defined in the specified configuration file
- installing a "Zabbix Agent" service for Windows using the default path to configuration file C:\Program Files\Zabbix Agent\zabbix_agentd.conf
- installing a "Zabbix Agent [Hostname]" service for Windows using the configuration file zabbix_agentd.conf located in the same folder as agent executable and making the service name unique by extending it by Hostname value from the config file
- modifying the startup type of an installed "Zabbix Agent" service for Windows using the configuration file zabbix_agentd.conf located in the same folder as agent executable

```
zabbix_agentd --print
zabbix_agentd -t "mysql.ping" -c /etc/zabbix/zabbix_agentd.conf
zabbix_agentd.exe -i
zabbix_agentd.exe -i -m -c zabbix_agentd.conf
zabbix_agentd.exe -c zabbix_agentd.conf -S delayed
```

Runtime control

With runtime control options you may change the log level of agent processes.

Option	Description	Target
log_level_increase[= target]	Increases log level. If target is not specified, all processes are affected.	Target can be specified as: process type - all processes of specified type (e.g., listener) See all agent process types . process type,N - process type and number (e.g., listener,3) pid - process identifier (1 to 65535). For larger values specify target as 'process-type,N'.
log_level_decrease[= target]	Decreases log level. If target is not specified, all processes are affected.	
userparameter_reload	Reload values of the <i>UserParameter</i> and <i>Include</i> options from the current configuration file.	

Examples:

- increasing log level of all processes
- increasing log level of the third listener process
- increasing log level of process with PID 1234
- decreasing log level of all active check processes

```
zabbix_agentd -R log_level_increase
zabbix_agentd -R log_level_increase=listener,3
zabbix_agentd -R log_level_increase=1234
zabbix_agentd -R log_level_decrease="active checks"
```

Note:

Runtime control is not supported on OpenBSD, NetBSD and Windows.

Agent process types

- `active_checks` - process for performing active checks
- `collector` - process for data collection
- `listener` - process for listening to passive checks

The agent log file can be used to observe these process types.

Process user

Zabbix agent on UNIX is designed to run as a non-root user. It will run as whatever non-root user it is started as. So you can run agent as any non-root user without any issues.

If you will try to run it as 'root', it will switch to a hardcoded 'zabbix' user, which must be present on your system. You can only run agent as 'root' if you modify the 'AllowRoot' parameter in the agent configuration file accordingly.

Configuration file

For details on configuring Zabbix agent see the configuration file options for `zabbix_agentd` or `Windows agent`.

Locale

Note that the agent requires a UTF-8 locale so that some textual agent items can return the expected content. Most modern Unix-like systems have a UTF-8 locale as default, however, there are some systems where that may need to be set specifically.

Exit code

Zabbix agent returns 0 in case of successful exit and 1 in case of failure.

3 Agent 2

Overview

Zabbix agent 2 is a new generation of Zabbix agent and may be used in place of Zabbix agent. Zabbix agent 2 has been developed to:

- reduce the number of TCP connections
- provide improved concurrency of checks
- be easily extendible with plugins. A plugin should be able to:
 - provide trivial checks consisting of only a few simple lines of code
 - provide complex checks consisting of long-running scripts and standalone data gathering with periodic sending back of the data
- be a drop-in replacement for Zabbix agent (in that it supports all the previous functionality)

Agent 2 is written in Go programming language (with some C code of Zabbix agent reused). A configured Go environment with a currently supported [Go version](#) is required for building Zabbix agent 2.

Agent 2 does not have built-in daemonization support on Linux; it can be run as a `Windows service`.

Passive and active checks

Passive checks work similarly to Zabbix agent. Active checks support scheduled/flexible intervals and check concurrency within one active server.

Note:

By default, after a restart, Zabbix agent 2 will schedule the first data collection for active checks at a conditionally random time within the item's update interval to prevent spikes in resource usage. To perform active checks that do not have `Scheduling update interval` immediately after the agent restart, set `ForceActiveChecksOnStart` parameter (global-level) or `Plugins.<Plugin name>.System.ForceActiveChecksOnStart` (affects only specific plugin checks) in the `configuration file`. Plugin-level parameter, if set, will override the global parameter.

Check concurrency

Checks from different plugins can be executed concurrently. The number of concurrent checks within one plugin is limited by the plugin capacity setting. Each plugin may have a hardcoded capacity setting (1000 being default) that can be lowered using the `Plugins.<PluginName>.System.Capacity=N` setting in the `Plugins` configuration `parameter`.

Supported platforms

Zabbix agent 2 is supported on the following platforms:

- Windows (all desktop and server versions [since Windows 10/Server 2016](#)) - available as a [pre-compiled binary](#) or in [Zabbix sources](#)
- Linux - available in [distribution packages](#) or [Zabbix sources](#)

Installation

To install Zabbix agent 2, the following options are available:

Windows:

- from a pre-compiled binary - download the binary and follow the instructions on the [Windows agent installation from MSI page](#)
- from sources - see [Building Zabbix agent 2 on Windows](#)

Linux:

- from distribution packages - follow the instructions on the [Zabbix packages](#) page, available by choosing your distribution and the Agent 2 component
- from sources - see [Installation from sources](#); note that you must configure the sources by specifying the `--enable-agent2` configuration option

Note:

Zabbix agent 2 monitoring capabilities can be extended with plugins. While built-in plugins are available out-of-the-box, loadable plugins must be installed separately. For more information, see [Plugins](#).

Options

The following command-line parameters can be used with Zabbix agent 2:

Parameter	Description
UNIX and Windows agent	
<code>-c --config <config-file></code>	Path to the configuration file. You may use this option to specify a configuration file that is not the default one. On UNIX, default is <code>/usr/local/etc/zabbix_agent2.conf</code> or as set by <code>compile-time</code> variables <code>--sysconfdir</code> or <code>--prefix</code> On Windows, default is <code>C:\Program Files\Zabbix Agent 2\zabbix_agent2.conf</code>
<code>-f --foreground</code>	Run Zabbix agent in foreground (default: true).
<code>-p --print</code>	Print known items and exit. <i>Note:</i> To return <code>user parameter</code> results as well, you must specify the configuration file (if it is not in the default location).
<code>-t --test <item key></code>	Test specified item and exit. <i>Note:</i> To return <code>user parameter</code> results as well, you must specify the configuration file (if it is not in the default location).
<code>-T --test-config</code>	Validate configuration file and exit.
<code>-h --help</code>	Print help information and exit.
<code>-v --verbose</code>	Print debugging information. Use this option with <code>-p</code> and <code>-t</code> options.
<code>-V --version</code>	Print agent version and license information.
<code>-R --runtime-control <option></code>	Perform administrative functions. See runtime control .
Windows agent only	
<code>-m --multiple-agents</code>	Use multiple agent instances (with <code>-i</code> , <code>-d</code> , <code>-s</code> , <code>-x</code> options). To distinguish service names of instances, each service name will include the Hostname value from the specified configuration file.
<code>-S --startup-type <value></code>	Set the startup type of the Zabbix Windows agent service. Allowed values: <code>automatic</code> - (<i>default</i>) start the service automatically at Windows startup; <code>delayed</code> - delay starting the service after the automatically started services have completed startup; <code>manual</code> - start the service manually (by a user or application); <code>disabled</code> - disable the service, so that it cannot be started by a user or application. You may use this option together with the <code>-i</code> option, or separately to modify the startup type of an already installed service.
<code>-i --install</code>	Install Zabbix Windows agent as service.

Parameter	Description
-d --uninstall	Uninstall Zabbix Windows agent service.
-s --start	Start Zabbix Windows agent service.
-x --stop	Stop Zabbix Windows agent service.

Specific **examples** of using command-line parameters:

- print all built-in agent items with values
- test a user parameter with "mysql.ping" key defined in the specified configuration file
- installing a "Zabbix Agent" service for Windows using the default path to configuration file C:\Program Files\Zabbix Agent 2\zabbix_agent2.conf
- modifying the startup type of an installed "Zabbix Agent" service for Windows using the configuration file zabbix_agent2.conf located in the same folder as agent executable

```
zabbix_agent2 --print
zabbix_agent2 -t "mysql.ping" -c /etc/zabbix/zabbix_agentd.conf
zabbix_agent2.exe -i
zabbix_agent2.exe -c zabbix_agent2.conf -S delayed
```

Runtime control

Runtime control provides some options for remote control.

Option	Description
log_level_increase	Increase log level.
log_level_decrease	Decrease log level.
metrics	List available metrics.
version	Display agent version.
userparameter_reload	Reload values of the <i>UserParameter</i> and <i>Include</i> options from the current configuration file.
help	Display help information on runtime control.

Examples:

- increasing log level for agent 2
- print runtime control options

```
zabbix_agent2 -R log_level_increase
zabbix_agent2 -R help
```

Configuration file

The configuration parameters of agent 2 are mostly compatible with Zabbix agent with some exceptions.

New parameters	Description
<i>ControlSocket</i>	The runtime control socket path. Agent 2 uses a control socket for runtime commands .
<i>EnablePersistentBuffer</i> , <i>PersistentBufferFile</i> , <i>PersistentBufferPeriod</i>	These parameters are used to configure persistent storage on agent 2 for active items.
<i>ForceActiveChecksOnStart</i>	Determines whether the agent should perform active checks immediately after restart or spread evenly over time.
<i>Plugins</i>	Plugins may have their own parameters, in the format <code>Plugins.<Plugin name>.<Parameter>=<value></code> . A common plugin parameter is <i>System.Capacity</i> , setting the limit of checks that can be executed at the same time.
<i>StatusPort</i>	The port agent 2 will be listening on for HTTP status request and display of a list of configured plugins and some internal parameters
Dropped parameters	Description
<i>AllowRoot</i> , <i>User</i>	Not supported because daemonization is not supported.
<i>LoadModule</i> , <i>LoadModulePath</i>	Loadable modules are not supported.
<i>StartAgents</i>	This parameter was used in Zabbix agent to increase passive check concurrency or disable them. In Agent 2, the concurrency is configured at a plugin level and can be limited by a capacity setting. Whereas disabling passive checks is not currently supported.

New parameters	Description
<i>HostInterface</i> , <i>HostInterfaceItem</i>	Not yet supported.

For more details see the configuration file options for [zabbix_agent2](#).

Exit codes

Zabbix agent 2 can also be compiled with older OpenSSL versions (1.0.1, 1.0.2).

In this case Zabbix provides mutexes for locking in OpenSSL. If a mutex lock or unlock fails then an error message is printed to the standard error stream (STDERR) and Agent 2 exits with return code 2 or 3, respectively.

4 Proxy

Overview

Zabbix proxy is a process that may collect monitoring data from one or more monitored devices and send the information to the Zabbix server, essentially working on behalf of the server. All collected data is buffered locally and then transferred to the Zabbix server the proxy belongs to.

Deploying a proxy is optional, but may be very beneficial to distribute the load of a single Zabbix server. If only proxies collect data, processing on the server becomes less CPU and disk I/O hungry.

A Zabbix proxy is the ideal solution for centralized monitoring of remote locations, branches and networks with no local administrators.

Zabbix proxy requires a separate database.

Attention:

Note that databases supported with Zabbix proxy are SQLite, MySQL and PostgreSQL.

See also: [Using proxies in a distributed environment](#)

Running proxy

If installed as package

Zabbix proxy runs as a daemon process. The proxy can be started by executing:

```
systemctl start zabbix-proxy
```

This will work on most of GNU/Linux systems. On other systems you may need to run:

```
/etc/init.d/zabbix-proxy start
```

Similarly, for stopping/restarting/viewing status of Zabbix proxy, use the following commands:

```
systemctl stop zabbix-proxy
systemctl restart zabbix-proxy
systemctl status zabbix-proxy
```

Start up manually

If the above does not work you have to start it manually. Find the path to the `zabbix_proxy` binary and execute:

```
zabbix_proxy
```

You can use the following command-line parameters with Zabbix proxy:

```
-c --config <file>           path to the configuration file
-f --foreground              run Zabbix proxy in foreground
-R --runtime-control <option> perform administrative functions
-T --test-config             validate configuration file and exit
-h --help                   give this help
-V --version                 display version number
```

Examples of running Zabbix proxy with command-line parameters:

```
zabbix_proxy -c /usr/local/etc/zabbix_proxy.conf
zabbix_proxy --help
zabbix_proxy -V
```

Runtime control

Runtime control options:

Option	Description	Target
<code>config_cache_reload</code>	Reload configuration cache. Ignored if cache is being currently loaded. Active Zabbix proxy will connect to the Zabbix server and request configuration data. Passive Zabbix proxy will request configuration data from Zabbix server the next time when the server connects to the proxy.	
<code>diaginfo[=<section>]</code>	Gather diagnostic information in the proxy log file.	historycache - history cache statistics preprocessing - preprocessing manager statistics locks - list of mutexes (is empty on <i>BSD</i> systems)
<code>snmp_cache_reload</code>	Reload SNMP cache, clear the SNMP properties (engine time, engine boots, engine id, credentials) for all hosts.	
<code>housekeeper_execute</code>	Start the housekeeping procedure. Ignored if the housekeeping procedure is currently in progress.	
<code>log_level_increase[=<target>]</code>	Increase log level, affects all processes if target is not specified. Not supported on <i>BSD</i> systems.	process type - All processes of specified type (e.g., poller) See all proxy process types . process type,N - Process type and number (e.g., poller,3) pid - Process identifier (1 to 65535). For larger values specify target as 'process type,N'.
<code>log_level_decrease[=<target>]</code>	Decrease log level, affects all processes if target is not specified. Not supported on <i>BSD</i> systems.	
<code>prof_enable[=<target>]</code>	Enable profiling. Affects all processes if target is not specified. Enabled profiling provides details of all rwlocks/mutexes by function name.	process type - All processes of specified type (e.g., history syncer) See all proxy process types . process type,N - Process type and number (e.g., history syncer,1) pid - Process identifier (1 to 65535). For larger values specify target as 'process type,N'. scope - rwlock, mutex, processing can be used with the process type and number (e.g., history syncer,1,processing) or all processes of type (e.g., history syncer,rwlock)
<code>prof_disable[=<target>]</code>	Disable profiling. Affects all processes if target is not specified.	process type - All processes of specified type (e.g., history syncer) See all proxy process types . process type,N - Process type and number (e.g., history syncer,1) pid - Process identifier (1 to 65535). For larger values specify target as 'process type,N'.

Example of using runtime control to reload the proxy configuration cache:

```
zabbix_proxy -c /usr/local/etc/zabbix_proxy.conf -R config_cache_reload
```

Examples of using runtime control to gather diagnostic information:

```
# Gather all available diagnostic information in the proxy log file:
```

```
zabbix_proxy -R diaginfo
```

```
# Gather history cache statistics in the proxy log file:
```

```
zabbix_proxy -R diaginfo=historycache
```

Example of using runtime control to reload the SNMP cache:

```
zabbix_proxy -R snmp_cache_reload
```

Example of using runtime control to trigger execution of housekeeper

```
zabbix_proxy -c /usr/local/etc/zabbix_proxy.conf -R housekeeper_execute
```

Examples of using runtime control to change log level:

```
# Increase log level of all processes:
```

```
zabbix_proxy -c /usr/local/etc/zabbix_proxy.conf -R log_level_increase
```

```
# Increase log level of second poller process:
```

```
zabbix_proxy -c /usr/local/etc/zabbix_proxy.conf -R log_level_increase=poller,2
```

```
# Increase log level of process with PID 1234:
```

```
zabbix_proxy -c /usr/local/etc/zabbix_proxy.conf -R log_level_increase=1234
```

```
# Decrease log level of all http poller processes:
```

```
zabbix_proxy -c /usr/local/etc/zabbix_proxy.conf -R log_level_decrease="http poller"
```

Process user

Zabbix proxy is designed to run as a non-root user. It will run as whatever non-root user it is started as. So you can run proxy as any non-root user without any issues.

If you will try to run it as 'root', it will switch to a hardcoded 'zabbix' user, which must be present on your system. You can only run proxy as 'root' if you modify the 'AllowRoot' parameter in the proxy configuration file accordingly.

Configuration file

See the [configuration file](#) options for details on configuring zabbix_proxy.

Proxy process types and threads

- `agent poller` - asynchronous poller process for passive checks with a worker thread
- `availability manager` - process for host availability updates
- `configuration syncer` - process for managing in-memory cache of configuration data
- `data sender` - proxy data sender
- `discovery manager` - manager process for discovery of devices
- `discovery worker` - process for handling discovery tasks from the discovery manager
- `history syncer` - history DB writer
- `housekeeper` - process for removal of old historical data
- `http agent poller` - asynchronous poller process for HTTP checks with a worker thread
- `http poller` - web monitoring poller
- `icmp pinger` - poller for icmping checks
- `ipmi manager` - IPMI poller manager
- `ipmi poller` - poller for IPMI checks
- `java poller` - poller for Java checks
- `odbc poller` - poller for ODBC checks
- `poller` - normal poller for passive checks
- `preprocessing manager` - manager of preprocessing tasks with preprocessing worker threads
- `preprocessing worker` - thread for data preprocessing
- `self-monitoring` - process for collecting internal server statistics
- `snmp poller` - asynchronous poller process for SNMP checks with a worker thread (`walk[OID]` and `get[OID]` items only)
- `snmp trapper` - trapper for SNMP traps
- `task manager` - process for remote execution of tasks requested by other components (e.g. close problem, acknowledge problem, check item value now, remote command functionality)
- `trapper` - trapper for active checks, traps, proxy communication
- `unreachable poller` - poller for unreachable devices
- `vmware collector` - VMware data collector responsible for data gathering from VMware services

The proxy log file can be used to observe these process types.

Various types of Zabbix proxy processes can be monitored using the **zabbix[process,<type>,<mode>,<state>]** internal [item](#).

Supported platforms

Zabbix proxy runs on the same list of [supported platforms](#) as Zabbix server.

Memory buffer

The memory buffer allows to store new data (item values, network discovery, host autoregistration) in the buffer and upload to Zabbix server without accessing the database. The memory buffer has been introduced for the proxy since Zabbix 7.0.

In installations before Zabbix 7.0 the collected data was stored in the database before uploading to Zabbix server. For these installations this remains the default behavior after upgrading to Zabbix 7.0.

For optimized performance, it is recommended to configure the use of memory buffer on the proxy. This is possible by modifying the value of `ProxyBufferMode` from "disk" (hardcoded default for existing installations) to "hybrid" (recommended) or "memory". It is also required to set the memory buffer size (`ProxyMemoryBufferSize` parameter).

In hybrid mode the buffer is protected from data loss by flushing unsent data to the database if the proxy is stopped, the buffer is full or data too old. When all values have been flushed into database, the proxy goes back to using memory buffer.

In memory mode, the memory buffer will be used, however, there is no protection against data loss. If the proxy is stopped, or the memory gets overfilled, the unsent data will be dropped.

The hybrid mode (`ProxyBufferMode=hybrid`) is applied to all new installations since Zabbix 7.0.

Additional parameters such as `ProxyMemoryBufferSize` and `ProxyMemoryBufferAge` define the memory buffer size and the maximum age of data in the buffer, respectively.

Note that with conflicting configuration the proxy will print an error and fail to start, for example, if:

- `ProxyBufferMode` is set to "hybrid" or "memory" and `ProxyMemoryBufferSize` is "0";
- `ProxyBufferMode` is set to "hybrid" or "memory" and `ProxyLocalBuffer` is not "0".

Locale

Note that the proxy requires a UTF-8 locale so that some textual items can be interpreted correctly. Most modern Unix-like systems have a UTF-8 locale as default, however, there are some systems where that may need to be set specifically.

5 Java gateway

Overview

Native support for monitoring JMX applications exists in the form of a Zabbix daemon called "Zabbix Java gateway". Zabbix Java gateway is a daemon written in Java. To find out the value of a particular JMX counter on a host, Zabbix server queries Zabbix Java gateway, which uses the [JMX management API](#) to query the application of interest remotely. The application does not need any additional software installed, it just has to be started with `-Dcom.sun.management.jmxremote` option on the command line.

Java gateway accepts incoming connection from Zabbix server or proxy and can only be used as a "passive proxy". As opposed to Zabbix proxy, it may also be used from Zabbix proxy (Zabbix proxies cannot be chained). Access to each Java gateway is configured directly in Zabbix server or proxy configuration file, thus only one Java gateway may be configured per Zabbix server or Zabbix proxy. If a host will have items of type **JMX agent** and items of other type, only the **JMX agent** items will be passed to Java gateway for retrieval.

When an item has to be updated over Java gateway, Zabbix server or proxy will connect to the Java gateway and request the value, which Java gateway in turn retrieves and passes back to the server or proxy. As such, Java gateway does not cache any values.

Zabbix server or proxy has a specific type of processes that connect to Java gateway, controlled by the option **StartJavaPollers**. Internally, Java gateway starts multiple threads, controlled by the **START_POLLERS** option. On the server side, if a connection takes more than **Timeout** seconds, it will be terminated, but Java gateway might still be busy retrieving value from the JMX counter. To solve this, there is the **TIMEOUT** option in Java gateway that allows to set timeout for JMX network operations.

Zabbix server or proxy will try to pool requests to a single JMX target together as much as possible (affected by item intervals) and send them to the Java gateway in a single connection for better performance.

It is suggested to have **StartJavaPollers** less than or equal to **START_POLLERS**, otherwise there might be situations when no threads are available in the Java gateway to service incoming requests; in such a case Java gateway uses `ThreadPoolExecutor.CallerRunsPolicy`, meaning that the main thread will service the incoming request and will not accept any new requests temporarily.

If you are trying to monitor Wildfly-based Java applications with Zabbix Java gateway, please install the latest `jboss-client.jar` available on the [Wildfly download page](#).

Getting Java gateway

You can install Java gateway either from the sources or packages downloaded from [Zabbix website](#).

Using the links below you can access information how to get and run Zabbix Java gateway, how to configure Zabbix server (or Zabbix proxy) to use Zabbix Java gateway for JMX monitoring, and how to configure Zabbix items in Zabbix frontend that correspond to particular JMX counters.

Installation from	Instructions	Instructions
<i>Sources</i>	Installation	Setup
<i>RHEL packages</i>	Installation	Setup
<i>Debian/Ubuntu packages</i>	Installation	Setup

1 Setup from sources

Overview

If **installed** from sources, the following information will help you in setting up Zabbix [Java gateway](#).

Overview of files

If you obtained Java gateway from sources, you should have ended up with a collection of shell scripts, JAR and configuration files under \$PREFIX/sbin/zabbix_java. The role of these files is summarized below.

bin/zabbix-java-gateway-\$VERSION.jar

Java gateway JAR file itself.

lib/logback-core-0.9.27.jar

lib/logback-classic-0.9.27.jar

lib/slf4j-api-1.6.1.jar

lib/android-json-4.3_r3.1.jar

Dependencies of Java gateway: [Logback](#), [SLF4J](#), and [Android JSON](#) library.

lib/logback.xml

lib/logback-console.xml

Configuration files for Logback.

shutdown.sh

startup.sh

Convenience scripts for starting and stopping Java gateway.

settings.sh

Configuration file that is sourced by startup and shutdown scripts above.

Configuring and running Java gateway

By default, Java gateway listens on port 10052. If you plan on running Java gateway on a different port, you can specify that in settings.sh script. See the description of [Java gateway configuration file](#) for how to specify this and other options.

Warning:

Port 10052 is not [IANA registered](#).

Once you are comfortable with the settings, you can start Java gateway by running the startup script:

```
./startup.sh
```

Likewise, once you no longer need Java gateway, run the shutdown script to stop it:

```
./shutdown.sh
```

Note that unlike server or proxy, Java gateway is lightweight and does not need a database.

Configuring server for use with Java gateway

With Java gateway up and running, you have to tell Zabbix server where to find Zabbix Java gateway. This is done by specifying JavaGateway and JavaGatewayPort parameters in the [server configuration file](#). If the host on which JMX application is running is monitored by Zabbix proxy, then you specify the connection parameters in the [proxy configuration file](#) instead.

```
JavaGateway=192.168.3.14
JavaGatewayPort=10052
```

By default, server does not start any processes related to JMX monitoring. If you wish to use it, however, you have to specify the number of pre-forked instances of Java pollers. You do this in the same way you specify regular pollers and trappers.

```
StartJavaPollers=5
```

Do not forget to restart server or proxy, once you are done with configuring them.

Debugging Java gateway

In case there are any problems with Java gateway or an error message that you see about an item in the frontend is not descriptive enough, you might wish to take a look at Java gateway log file.

By default, Java gateway logs its activities into /tmp/zabbix_java.log file with log level "info". Sometimes that information is not enough and there is a need for information at log level "debug". In order to increase logging level, modify file lib/logback.xml and change the level attribute of <root> tag to "debug":

```
<root level="debug">
  <appender-ref ref="FILE" />
</root>
```

Note that unlike Zabbix server or Zabbix proxy, there is no need to restart Zabbix Java gateway after changing logback.xml file - changes in logback.xml will be picked up automatically. When you are done with debugging, you can return the logging level to "info".

If you wish to log to a different file or a completely different medium like database, adjust logback.xml file to meet your needs. See [Logback Manual](#) for more details.

Sometimes for debugging purposes it is useful to start Java gateway as a console application rather than a daemon. To do that, comment out PID_FILE variable in settings.sh. If PID_FILE is omitted, startup.sh script starts Java gateway as a console application and makes Logback use lib/logback-console.xml file instead, which not only logs to console, but has logging level "debug" enabled as well.

Finally, note that since Java gateway uses SLF4J for logging, you can replace Logback with the framework of your choice by placing an appropriate JAR file in lib directory. See [SLF4J Manual](#) for more details.

JMX monitoring

See [JMX monitoring](#) page for more details.

2 Setup from RHEL packages

Overview

If [installed](#) from RHEL packages, the following information will help you in setting up Zabbix [Java gateway](#).

Configuring and running Java gateway

Configuration parameters of Zabbix Java gateway may be tuned in the file:

```
/etc/zabbix/zabbix_java_gateway.conf
```

For more details, see Zabbix Java gateway configuration [parameters](#).

To start Zabbix Java gateway:

```
systemctl restart zabbix-java-gateway
```

To automatically start Zabbix Java gateway on boot:

RHEL 7 and later:

```
systemctl enable zabbix-java-gateway
```

RHEL prior to 7:

```
chkconfig --level 12345 zabbix-java-gateway on
```

Configuring server for use with Java gateway

With Java gateway up and running, you have to tell Zabbix server where to find Zabbix Java gateway. This is done by specifying JavaGateway and JavaGatewayPort parameters in the [server configuration file](#). If the host on which JMX application is running is monitored by Zabbix proxy, then you specify the connection parameters in the [proxy configuration file](#) instead.

```
JavaGateway=192.168.3.14
JavaGatewayPort=10052
```

By default, server does not start any processes related to JMX monitoring. If you wish to use it, however, you have to specify the number of pre-forked instances of Java pollers. You do this in the same way you specify regular pollers and trappers.

```
StartJavaPollers=5
```

Do not forget to restart server or proxy, once you are done with configuring them.

Debugging Java gateway

Zabbix Java gateway log file is:

```
/var/log/zabbix/zabbix_java_gateway.log
```

If you like to increase the logging, edit the file:

```
/etc/zabbix/zabbix_java_gateway_logback.xml
```

and change level="info" to "debug" or even "trace" (for deep troubleshooting):

```
<configuration scan="true" scanPeriod="15 seconds">
[... ]
  <root level="info">
    <appender-ref ref="FILE" />
  </root>
</configuration>
```

JMX monitoring

See [JMX monitoring](#) page for more details.

3 Setup from Debian/Ubuntu packages

Overview

If [installed](#) from Debian/Ubuntu packages, the following information will help you in setting up Zabbix [Java gateway](#).

Configuring and running Java gateway

Java gateway configuration may be tuned in the file:

```
/etc/zabbix/zabbix_java_gateway.conf
```

For more details, see [Zabbix Java gateway configuration parameters](#).

To start Zabbix Java gateway:

```
systemctl restart zabbix-java-gateway
```

To automatically start Zabbix Java gateway on boot:

```
systemctl enable zabbix-java-gateway
```

Configuring server for use with Java gateway

With Java gateway up and running, you have to tell Zabbix server where to find Zabbix Java gateway. This is done by specifying JavaGateway and JavaGatewayPort parameters in the [server configuration file](#). If the host on which JMX application is running is monitored by Zabbix proxy, then you specify the connection parameters in the [proxy configuration file](#) instead.

```
JavaGateway=192.168.3.14
JavaGatewayPort=10052
```

By default, server does not start any processes related to JMX monitoring. If you wish to use it, however, you have to specify the number of pre-forked instances of Java pollers. You do this in the same way you specify regular pollers and trappers.

```
StartJavaPollers=5
```

Do not forget to restart server or proxy, once you are done with configuring them.

Debugging Java gateway

Zabbix Java gateway log file is:

```
/var/log/zabbix/zabbix_java_gateway.log
```

If you like to increase the logging, edit the file:

```
/etc/zabbix/zabbix_java_gateway_logback.xml
```

and change `level="info"` to `"debug"` or even `"trace"` (for deep troubleshooting):

```
<configuration scan="true" scanPeriod="15 seconds">
[...]
  <root level="info">
    <appender-ref ref="FILE" />
  </root>
</configuration>
```

JMX monitoring

See [JMX monitoring](#) page for more details.

6 Sender

Overview

Zabbix sender is a command line utility that may be used to send performance data to Zabbix server for processing.

The utility is usually used in long running user scripts for periodical sending of availability and performance data.

For sending results directly to Zabbix server or proxy, a [trapper item](#) type must be configured.

See also [zabbix_utils](#) - a Python library that has built-in functionality to act like Zabbix sender.

Running Zabbix sender

An example of running Zabbix UNIX sender:

```
cd bin
./zabbix_sender -z zabbix -s "Linux DB3" -k db.connections -o 43
```

where:

- `z` - Zabbix server host (IP address can be used as well)
- `s` - technical name of monitored host (as registered in Zabbix frontend)
- `k` - item key
- `o` - value to send

Attention:

Options that contain whitespaces, must be quoted using double quotes.

Zabbix sender can be used to send multiple values from an input file. See the [Zabbix sender manpage](#) for more information.

If a configuration file is specified, Zabbix sender uses all addresses defined in the agent `ServerActive` configuration parameter for sending data. If sending to one address fails, the sender tries sending to the other addresses. If sending of batch data fails to one address, the following batches are not sent to this address.

Zabbix sender accepts strings in UTF-8 encoding (for both UNIX-like systems and Windows) without byte order mark (BOM) first in the file.

Zabbix sender on Windows can be run similarly:

```
zabbix_sender.exe [options]
```

`zabbix_sender` realtime sending scenarios will gather multiple values passed to it in close succession and send them to the server in a single connection. A value that is not further apart from the previous value than 0.2 seconds can be put in the same stack, but maximum polling time still is 1 second.

Note:

Zabbix sender will terminate if invalid (not following `parameter=value` notation) parameter entry is present in the specified configuration file.

Running Zabbix sender with low-level discovery

An example of running Zabbix sender for sending a JSON-formatted value for low-level discovery:

```
./zabbix_sender -z 192.168.1.113 -s "Zabbix server" -k trapper.discovery.item -o '[{"#FSNAME}":"/",{"#FSNAME}":"/",{"#FSNAME}":"/",{"#FSNAME}":"/"]'
```

For this to work, the low-level discovery rule must have a Zabbix trapper item type (in this example, with `trapper.discovery.item` key).

7 Get

Overview

Zabbix get is a command-line utility, which can be used to communicate with Zabbix agent and retrieve required information from the agent.

The utility is usually used for the troubleshooting of Zabbix agents.

See also [zabbix_utils](#) - a Python library that has built-in functionality to act like Zabbix get.

Running Zabbix get

An example of running Zabbix get under UNIX to get the processor load value from the agent:

```
cd bin
./zabbix_get -s 127.0.0.1 -p 10050 -k system.cpu.load[all,avg1]
```

Another example of running Zabbix get for capturing a string from a website:

```
cd bin
./zabbix_get -s 192.168.1.1 -p 10050 -k "web.page.regex[www.example.com,,,\"USA: ([a-zA-Z0-9.-]+)\",,\\1]"
```

Note that the item key here contains a space so quotes are used to mark the item key to the shell. The quotes are not part of the item key; they will be trimmed by the shell and will not be passed to Zabbix agent.

If an item key is unsupported Zabbix get will return the exit code 1.

Zabbix get accepts the following command line parameters:

<code>-s --host <host name or IP></code>	Specify host name or IP address of a host
<code>-p --port <port number></code>	Specify port number of agent running on the host (default: 10050)
<code>-I --source-address <IP address></code>	Specify source IP address
<code>-t --timeout <seconds></code>	Specify timeout. Valid range: 1-30 seconds (default: 30 seconds)
<code>-k --key <item key></code>	Specify key of item to retrieve value for
<code>-P --protocol <value></code>	Protocol used to communicate with agent. Values: auto - connect using JSON protocol, fallback and retry with plaintext json - connect using JSON protocol plaintext - connect using plaintext protocol where just item key is used
<code>-h --help</code>	Display this help message
<code>-V --version</code>	Display version number
<code>--tls-connect <value></code>	How to connect to agent. Values: unencrypted - connect without encryption (default) psk - connect using TLS and a pre-shared key cert - connect using TLS and a certificate
<code>--tls-ca-file <CA file></code>	Full pathname of a file containing the top-level CA(s) certificate
<code>--tls-crl-file <CRL file></code>	Full pathname of a file containing revoked certificates
<code>--tls-agent-cert-issuer <cert issuer></code>	Allowed agent certificate issuer
<code>--tls-agent-cert-subject <cert subject></code>	Allowed agent certificate subject
<code>--tls-cert-file <cert file></code>	Full pathname of a file containing the certificate or certificate chain
<code>--tls-key-file <key file></code>	Full pathname of a file containing the private key
<code>--tls-psk-identity <PSK-identity></code>	Unique, case sensitive string used to identify the pre-shared key
<code>--tls-psk-file <PSK-file></code>	Full pathname of a file containing the pre-shared key
<code>--tls-cipher13 <cipher-string></code>	Cipher string for OpenSSL 1.1.1 or newer for TLS 1.3. Override the default
<code>--tls-cipher <cipher-string></code>	GnuTLS priority string (for TLS 1.2 and up) or OpenSSL cipher string

See also [Zabbix get manpage](#) for more information.

Zabbix get on Windows can be run similarly:

```
zabbix_get.exe [options]
```

8 JS

Overview

`zabbix_js` is a command line utility that can be used for embedded script testing.

This utility will execute a user script with a string parameter and print the result. Scripts are executed using the embedded Zabbix scripting engine.

In case of compilation or execution errors `zabbix_js` will print the error in `stderr` and exit with code 1.

Usage

```
zabbix_js -s script-file -p input-param [-l log-level] [-t timeout]
zabbix_js -s script-file -i input-file [-l log-level] [-t timeout]
zabbix_js -h
zabbix_js -V
```

`zabbix_js` accepts the following command line parameters:

<code>-s, --script script-file</code>	Specify the file name of the script to execute. If '-' is specified as
<code>-i, --input input-file</code>	Specify the file name of the input parameter. If '-' is specified as f
<code>-p, --param input-param</code>	Specify the input parameter.
<code>-l, --loglevel log-level</code>	Specify the log level.
<code>-t, --timeout timeout</code>	Specify the timeout in seconds. Valid range: 1-60 seconds (default: 10
<code>-h, --help</code>	Display help information.
<code>-V, --version</code>	Display the version number.
<code>-w <webdriver url></code>	Enables browser monitoring.

Example:

```
zabbix_js -s script-file.js -p example
```

9 Web service

Overview

Zabbix web service is a process that is used for communication with external web services. Currently, Zabbix web service is used for generating and sending **scheduled reports** with plans to add additional functionality in the future.

Zabbix server connects to the web service via HTTP(S). Zabbix web service requires Google Chrome to be installed on the same host; on some distributions the service may also work with Chromium (see **known issues**).

Installation

The official `zabbix-web-service` package is available in the [Zabbix repository](#).

To compile Zabbix web service **from sources**, specify the `--enable-webservice` configure option.

To configure Zabbix web service, update the `zabbix_web_service.conf` configuration file parameters.

Attention:

It is strongly recommended to set up encryption between Zabbix server and Zabbix web service **using certificates**. By default, data transmitted between Zabbix server and Zabbix web service is not encrypted, which can lead to unauthorized access.

4 Installation

Please use the sidebar to access content in the Installation section.

1 Getting Zabbix

Overview

There are four ways of getting Zabbix:

- Install it from the [distribution packages](#)
- Download the latest source archive and [compile it yourself](#)
- Install it from the [containers](#)
- Download the [virtual appliance](#)

To download the latest distribution packages, pre-compiled sources or the virtual appliance, go to the [Zabbix download page](#), where direct links to latest versions are provided.

Getting Zabbix source code

There are several ways of getting Zabbix source code:

- You can [download](#) the released stable versions from the official Zabbix website
- You can [download](#) nightly builds from the official Zabbix website developer page
- You can get the latest development version from the Git source code repository system:
 - The primary location of the full repository is at <https://git.zabbix.com/scm/zbx/zabbix.git>
 - Master and supported releases are also mirrored to Github at <https://github.com/zabbix/zabbix>

A Git client must be installed to clone the repository. The official commandline Git client package is commonly called **git** in distributions. To install, for example, on Debian/Ubuntu, run:

```
sudo apt-get update
sudo apt-get install git
```

To grab all Zabbix source, change to the directory you want to place the code in and execute:

```
git clone https://git.zabbix.com/scm/zbx/zabbix.git
```

2 Requirements

Hardware

Memory

Zabbix requires both physical and disk memory. The amount of required disk memory obviously depends on the number of hosts and parameters that are being monitored. If you're planning to keep a long history of monitored parameters, you should be thinking of at least a couple of gigabytes to have enough space to store the history in the database. Each Zabbix daemon process requires several connections to a database server. The amount of memory allocated for the connection depends on the configuration of the database engine.

Note:

The more physical memory you have, the faster the database (and therefore Zabbix) works.

CPU

Zabbix and especially Zabbix database may require significant CPU resources depending on number of monitored parameters and chosen database engine.

Other hardware

A serial communication port and a serial GSM modem are required for using SMS notification support in Zabbix. USB-to-serial converter will also work.

Examples of hardware configuration

The table provides examples of hardware configuration, assuming a **Linux/BSD/Unix** platform.

These are size and hardware configuration examples to start with. Each Zabbix installation is unique. Make sure to benchmark the performance of your Zabbix system in a staging or development environment, so that you can fully understand your requirements before deploying the Zabbix installation to its production environment.

Installation size	Monitored metrics ¹	CPU/vCPU cores	Memory (GiB)	Database	Amazon EC2 ²
Small	1 000	2	8	MySQL Server, Percona Server, MariaDB Server, PostgreSQL	m6i.large/m6g.large
Medium	10 000	4	16	MySQL Server, Percona Server, MariaDB Server, PostgreSQL	m6i.xlarge/m6g.xlarge
Large	100 000	16	64	MySQL Server, Percona Server, MariaDB Server, PostgreSQL	m6i.4xlarge/m6g.4xlarge
Very large	1 000 000	32	96	MySQL Server, Percona Server, MariaDB Server, PostgreSQL	m6i.8xlarge/m6g.8xlarge

¹ 1 metric = 1 item + 1 trigger + 1 graph
² Example with Amazon general purpose EC2 instances, using ARM64 or x86_64 architecture, a proper instance type like Compute/Memory/Storage optimised should be selected during Zabbix installation evaluation and testing before installing in its production environment.

Note:

Actual configuration depends on the number of active items and refresh rates very much (see [database size](#) section of this page for details). It is highly recommended to run the database on a separate server for large installations.

Supported platforms

Due to security requirements and the mission-critical nature of the monitoring server, UNIX is the only operating system that can consistently deliver the necessary performance, fault tolerance, and resilience. Zabbix operates on market-leading versions.

Zabbix components are available and tested for the following platforms:

Platform	Server	Agent	Agent2
Linux	x	x	x
IBM AIX	x	x	-
FreeBSD	x	x	-
NetBSD	x	x	-
OpenBSD	x	x	-
HP-UX	x	x	-
Mac OS X	x	x	-
Solaris	x	x	-
Windows	-	x	x

Note:

Zabbix server/agent may work on other Unix-like operating systems as well. Zabbix agent is supported on all Windows desktop and server versions since XP (64-bit version). Zabbix agent will not work on AIX platforms below versions 6.1 TL07 / AIX 7.1 TL01.

To prevent critical security vulnerabilities in Zabbix agent 2, it is compiled only with [supported Go releases](#). As of Go 1.21, the [minimum required Windows versions](#) are raised, therefore, the minimum Windows version for Zabbix agent 2 is Windows 10/Server 2016.

Attention:

Zabbix disables core dumps if compiled with encryption and does not start if the system does not allow disabling of core dumps.

Required software

Zabbix is built around modern web servers, leading database engines, and PHP scripting language.

Third-party external surrounding software

If stated as mandatory, the required software/library is strictly necessary. Optional ones are needed for supporting some specific function.

Software	Mandatory status	Supported versions	Comments
<i>MySQL/Percona</i>	One of	8.0.30-9.0.X	Required if MySQL (or Percona) is used as Zabbix backend database. InnoDB engine is required. We recommend using the C API (libmysqlclient) library for building server/proxy.
<i>MariaDB</i>		10.5.00-11.5.X	InnoDB engine is required. The recommended version is 11.4. We recommend using the MariaDB Connector/C library for building server/proxy.
<i>PostgreSQL</i>		13.0-17.X	See also: Possible deadlocks with MariaDB . Required if PostgreSQL is used as Zabbix backend database. Depending on the installation size, it might be required to increase PostgreSQL <i>work_mem</i> configuration property (4MB being the default value), so that the amount of memory used by the database for particular operation is sufficient and query execution does not take too much time.
<i>TimescaleDB for PostgreSQL</i>		2.13.0-2.17.X	Required if TimescaleDB is used as a PostgreSQL database extension. Make sure to install TimescaleDB Community Edition, which supports compression. Note that PostgreSQL 15 is supported since TimescaleDB 2.10. You may also refer to Timescale documentation for details regarding PostgreSQL and TimescaleDB version compatibility.
<i>SQLite</i>	Optional	3.3.5-3.34.X	SQLite is only supported with Zabbix proxies. Required if SQLite is used as Zabbix proxy database.
<i>smartmontools</i>		7.1 or later	Required for Zabbix agent 2.
<i>who</i>			Required for the user count plugin.
<i>dpkg</i>			Required for the system.sw.packages plugin.
<i>pkgtool</i>			Required for the system.sw.packages plugin.
<i>rpm</i>			Required for the system.sw.packages plugin.
<i>pacman</i>			Required for the system.sw.packages plugin.
<i>q applets</i>			<i>qlist</i> and <i>qsize</i> , as part of q applets , are required for the system.sw.packages plugin on Gentoo Linux.

Note:

Although Zabbix can work with databases available in the operating systems, for the best experience, we recommend using databases installed from the official database developer repositories.

Frontend

The minimum supported screen width for Zabbix frontend is 1200px.

If stated as mandatory, the required software/library is strictly necessary. Optional ones are needed for supporting some specific function.

Software	Mandatory status	Supported versions	Comments
<i>PHP</i>	Yes	8.0.0 - 8.3.X	
<i>Apache</i>	One of	2.4 or later	

Software	Mandatory status	Supported versions	Comments
<i>Nginx</i>		1.20 or later	
<i>MySQL</i> <i>PostgreSQL</i>	One of		
PHP extensions <i>mysqli</i> <i>pgsql</i> <i>bcmath</i> <i>mbstring</i> <i>sockets</i> <i>gd</i>	Yes	2.0.28 or later	Required if MySQL is used as Zabbix backend database. Required if PostgreSQL is used as Zabbix backend database. php-bcmath (<i>--enable-bcmath</i>) php-mbstring (<i>--enable-mbstring</i>) php-net-socket (<i>--enable-sockets</i>); required for user script support. php-gd (if provided as a separate package by the distributor); PHP GD extension must support PNG images (<i>--with-png-dir</i>), JPEG images (<i>--with-jpeg-dir</i>), and FreeType 2 (<i>--with-freetype-dir</i>). Version 2.3.0 or later may be required to avoid possible text overlapping in graphs for some frontend languages.
<i>libxml</i> <i>xmlwriter</i> <i>xmlreader</i> <i>ctype</i> <i>session</i> <i>ldap</i> <i>openssl</i> <i>gettext</i> <i>curl</i>	No	2.6.15 or later	php-xml (if provided as a separate package by the distributor) php-xmlwriter (if provided as a separate package by the distributor) php-xmlreader (if provided as a separate package by the distributor) php-ctype (<i>--enable-ctype</i>) php-session (if provided as a separate package by the distributor) php-ldap; required for LDAP authentication. php-openssl; required for SAML authentication. php-gettext (<i>--with-gettext</i>); required for translations. php-curl; required for the Duo Universal Prompt multi-factor authentication option.

Third-party frontend libraries that are supplied with Zabbix:

Library	Mandatory status	Minimum version	Comments
jQuery JavaScript Library jQuery UI	Yes	3.6.0 1.12.1	JavaScript library that simplifies the process of cross-browser development. A set of user interface interactions, effects, widgets, and themes built on top of jQuery.
SAML PHP Toolkit		4.0.0	A PHP toolkit that adds SAML 2.0 authentication support to be able to sign in to Zabbix.
Symfony Yaml Component		5.1.0	Adds support to export and import Zabbix configuration elements in the YAML format.

Note:

Zabbix may work on previous versions of Apache, MySQL, and PostgreSQL as well.

Attention:

For other fonts than the default DejaVu, PHP function [imagerotate](#) might be required. If it is missing, these fonts might be rendered incorrectly when a graph is displayed. This function is only available if PHP is compiled with bundled GD, which is not the case in Debian and other distributions.

Third-party libraries used for writing and debugging Zabbix frontend code:

Library	Mandatory status	Minimum version	Description
Composer	No	2.4.1	An application-level package manager for PHP that provides a standard format for managing dependencies of PHP software and required libraries.
PHPUnit		8.5.29	A PHP unit testing framework for testing Zabbix frontend.

Library	Mandatory status	Minimum version	Description
SASS		3.4.22	A preprocessor scripting language that is interpreted and compiled into Cascading Style Sheets (CSS).

Web browser on client side

Cookies and JavaScript must be enabled.

The latest stable versions of Google Chrome, Mozilla Firefox, Microsoft Edge, Apple Safari, and Opera are supported.

Warning:

The same-origin policy for IFrames is implemented, which means that Zabbix cannot be placed in frames on a different domain.

Still, pages placed into a Zabbix frame will have access to Zabbix frontend (through JavaScript) if the page that is placed in the frame and Zabbix frontend are on the same domain. A page like `http://secure-zabbix.com/cms/page.html`, if placed into dashboards on `http://secure-zabbix.com/zabbix/`, will have full JS access to Zabbix.

Server/proxy

If stated as mandatory, the required software/library is strictly necessary. Optional ones are needed for supporting some specific function.

Requirement	Mandatory status	Description
<i>libpcre/libpcre2</i>	One of	PCRE/PCRE2 library is required for Perl Compatible Regular Expression (PCRE) support. The naming may differ depending on the GNU/Linux distribution, for example 'libpcre3' or 'libpcre1'. PCRE v8.x and PCRE2 v10.x are supported.
<i>libevent</i>	Yes	Required for inter-process communication. Version 2.0.10 or higher.
<i>libevent-threads</i>		Required for inter-process communication.
<i>libpthread</i>		Required for mutex and read-write lock support (could be part of libc).
<i>libresolv</i>		Required for DNS resolution (could be part of libc).
<i>libiconv</i>		Required for text encoding/format conversion (could be part of libc). Mandatory for Zabbix server on Linux.
<i>libz</i>	One of	Required for compression support.
<i>libm</i>		Math library. Required by Zabbix server only.
<i>libmysqlclient</i>		Required if MySQL is used.
<i>libmariadb</i>		Required if MariaDB is used.
<i>libpq5</i>		Required if PostgreSQL is used; <i>libpq5</i> version must match or be higher than the version of the PostgreSQL database used.
<i>libsqlite3</i>	No	Required if Sqlite is used. Required for Zabbix proxy only.
<i>libOpenIPMI</i>		Required for IPMI support. Required for Zabbix server only.
<i>libssh2</i> or <i>libssh</i>		Required for SSH checks . Version 1.0 or higher (libssh2); 0.9.0 or higher (libssh).
<i>libcurl</i>		Required for web monitoring, VMware monitoring, SMTP authentication, <code>web.page.*</code> Zabbix agent items , HTTP agent items and Elasticsearch (if used). Version 7.19.1 or higher is required (7.28.0 or higher is recommended). Libcurl version requirements: - SMTP authentication: version 7.20.0 or higher - Elasticsearch: version 7.28.0 or higher To make use of upgraded cURL features, restart Zabbix server/proxy and agent (for <code>web.page.*</code> items).
<i>libxml2</i>		Required for VMware monitoring and XML XPath preprocessing.
<i>net-snmp</i>		Required for SNMP support. Version 5.3.0 or higher. Support of strong encryption protocols (AES192/AES192C, AES256/AES256C) is available starting with net-snmp library 5.8; on RHEL 8+ based systems it is recommended to use net-snmp 5.8.15 or later.
<i>libunixodbc</i>		Required for database monitoring.
<i>libgnutls</i> or <i>libopenssl</i>		Required when using encryption . Minimum versions: <i>libgnutls</i> - 3.1.18, <i>libopenssl</i> - 1.0.1
<i>libldap</i>		Required for LDAP support.

Requirement	Mandatory status	Description
<i>fping</i>		Required for ICMP ping items .

Agent

Requirement	Mandatory status	Description
<i>libpcre/libpcre2</i>	One of	PCRE/PCRE2 library is required for Perl Compatible Regular Expression (PCRE) support. The naming may differ depending on the GNU/Linux distribution, for example 'libpcre3' or 'libpcre1'. PCRE v8.x and PCRE2 v10.x are supported. Required for log monitoring. Also required on Windows.
<i>libpthread</i>	Yes	Required for mutex and read-write lock support (could be part of libc). Not required on Windows.
<i>libresolv</i>		Required for DNS resolution (could be part of libc). Not required on Windows.
<i>libiconv</i>		Required for text encoding/format conversion to UTF-8 in log items, file content, file regex and regmatch items (could be part of libc). Not required on Windows.
<i>libgnutls</i> or <i>libopenssl</i>	No	Required if using encryption . Minimum versions: <i>libgnutls</i> - 3.1.18, <i>libopenssl</i> - 1.0.1 On Microsoft Windows OpenSSL 1.1.1 or later is required.
<i>libldap</i>		Required if LDAP is used. Not supported on Windows.
<i>libcurl</i>		Required for <code>web.page.*</code> Zabbix agent items . Not supported on Windows. Version 7.19.1 or higher is required (7.28.0 or higher is recommended). To make use of upgraded cURL features, restart Zabbix agent.
<i>libmodbus</i>		Only required if Modbus monitoring is used. Version 3.0 or higher.

Agent 2

Requirement	Mandatory status	Description
<i>libpcre/libpcre2</i>	One of	PCRE/PCRE2 library is required for Perl Compatible Regular Expression (PCRE) support. The naming may differ depending on the GNU/Linux distribution, for example 'libpcre3' or 'libpcre1'. PCRE v8.x and PCRE2 v10.x are supported. Required for log monitoring. Also required on Windows.
<i>libopenssl</i>	No	Required when using encryption. OpenSSL 1.0.1 or later is required on UNIX platforms. The OpenSSL library must have PSK support enabled. LibreSSL is not supported. On Microsoft Windows systems OpenSSL 1.1.1 or later is required.

Go libraries

Requirement	Mandatory status	Minimum version	Description
git.zabbix.com/ap/plugin-support	Yes	1.X.X	Zabbix own support library. Mostly for plugins.
github.com/BurntSushi/locker		0.0.0	Named read/write locks, access sync.
github.com/chromedp/cdproto		0.0.0	Generated commands, types, and events for the Chrome DevTools Protocol domains.
github.com/chromedp/chromedp		0.6.0	Chrome DevTools Protocol support (report generation).
github.com/dustin/gomemcached		0.0.0	A memcached binary protocol toolkit for go.
github.com/eclipse/paho.mqtt.golang		1.2.0	A library to handle MQTT connections.
github.com/fsnotify/fsnotify		1.4.9	Cross-platform file system notifications for Go.
github.com/go-ldap/ldap		3.0.3	Basic LDAP v3 functionality for the Go programming language.
github.com/go-ole/ole		1.2.4	Win32 ole implementation for Go.

Requirement	Mandatory status	Minimum version	Description
github.com/godbus/dbus		4.1.0	Native Go bindings for D-Bus.
github.com/go-sql-driver/mysql		1.5.0	MySQL driver.
github.com/godror/godror		0.20.1	Oracle DB driver.
github.com/matttn/go-sqlite3		2.0.3	Sqlite3 driver.
github.com/mediocregopher/radix/v3		3.5.0	Redis client.
github.com/memcachier/mc/v3		3.0.1	Binary Memcached client.
github.com/miekg/dns		1.1.43	DNS library.
github.com/omeid/go-yarn		0.0.1	Embeddable filesystem mapped key-string store.
github.com/goburrow/modbus		0.1.0	Fault-tolerant implementation of Modbus.
golang.org/x/sys		0.0.0	Go packages for low-level interactions with the operating system. Also used in plugin support lib. Used in MongoDB and PostgreSQL plugins.
github.com/Microsoft/go-winio	On Windows. Yes, indirect ¹	0.6.0	Windows named pipe implementation. Also used in plugin support lib. Used in MongoDB and PostgreSQL plugins.
github.com/goburrow/serial	Yes, indirect ¹	0.1.0	Serial library for Modbus.
golang.org/x/xerrors		0.0.0	Functions to manipulate errors.
gopkg.in/asn1-ber.v1		1.0.0	Encoding/decoding library for ASN1 BER.
github.com/go-stack/stack	No, indirect ¹	1.8.0	
github.com/golang/snappy		0.0.1	
github.com/klauspost/compress		1.13.6	
github.com/xdg-go/pbkdf2		1.0.0	
github.com/xdg-go/scram		1.0.2	
github.com/xdg-go/stringprep		1.0.2	
github.com/youmark/pkcs8		0.0.0	

¹ "Indirect" means that it is used in one of the libraries that the agent uses. It's required since Zabbix uses the library that uses the package.

See also dependencies for loadable plugins:

- [PostgreSQL](#)
- [MongoDB](#)

Java gateway

If you obtained Zabbix from the source repository or an archive, then the necessary dependencies are already included in the source tree.

If you obtained Zabbix from your distribution's package, then the necessary dependencies are already provided by the packaging system.

In both cases above, the software is ready to be used and no additional downloads are necessary.

If, however, you wish to provide your versions of these dependencies (for instance, if you are preparing a package for some Linux distribution), below is the list of library versions that Java gateway is known to work with. Zabbix may work with other versions of these libraries, too.

The following table lists JAR files that are currently bundled with Java gateway in the original code:

Library	Mandatory status	Minimum version	Comments
android-json	Yes	4.3r1	JSON (JavaScript Object Notation) is a lightweight data-interchange format. This is the org.json compatible Android implementation extracted from the Android SDK.
logback-classic		1.2.9	
logback-core		1.2.9	
slf4j-api		1.7.32	

Java gateway can be built using either Oracle Java or open source OpenJDK (version 1.6 or newer). Packages provided by Zabbix are compiled using OpenJDK. The following table lists OpenJDK packages used for building Zabbix packages by distribution:

Distribution	OpenJDK package
AlmaLinux 9	java-11-openjdk-devel (amd64: 11.0.19.0.7-4; arm64: 11.0.20.0.8-3)
AlmaLinux 8	java-1.8.0-openjdk-devel (amd64: 1.8.0.332.b09-2; arm64: 1.8.0.382.b05-2)
Amazon Linux 2023	java-22-amazon-corretto-devel (amd64, arm64: 22.0.2+9-1)
CentOS Stream 9	java-11-openjdk-devel (amd64, arm64: 11.0.18.0.10-3)
CentOS Stream 8	java-1.8.0-openjdk-devel (amd64, arm64: 1.8.0.362.b08-3)
CentOS 7	java-1.8.0-openjdk-devel (amd64: 1.8.0.282.b08-1)
Debian 12	default-jdk-headless (amd64, arm64: 2:1.17-74)
Debian 11	default-jdk-headless (amd64: 2:1.11-72)
OpenSUSE Leap 15	java-17-openjdk-devel (amd64: 17.0.5.0-150400.3.9.3; arm64: 17.0.8.0-150400.3.27.1)
Oracle Linux 9	java-11-openjdk-devel (amd64: 11.0.19.0.7-4.0.1; arm64: 11.0.20.0.8-2.0.1)
Oracle Linux 8	java-1.8.0-openjdk-devel (amd64: 1.8.0.372.b07-4.0.1); java-11-openjdk-devel (arm64: 11.0.20.0.8-3.0.1)
Oracle Linux 7	java-1.8.0-openjdk-devel (amd64: 1.8.0.282.b08-1)
Raspberry Pi OS 12	default-jdk-headless (arm64, armhf: 2:1.17-74)
Raspberry Pi OS 11	default-jdk-headless (arm64: 2:1.11-72; armhf: 2:1.11-72+b4)
RHEL 9	java-11-openjdk-devel (amd64: 11.0.19.0.7-4; arm64: 11.0.20.0.8-3)
RHEL 8	java-1.8.0-openjdk-devel (amd64: 1.8.0.372.b07-4; arm64: 1.8.0.382.b05-2)
RHEL 7	java-1.8.0-openjdk-devel (amd64: 1.8.0.282.b08-1)
Rocky Linux 9	java-11-openjdk-devel (amd64: 11.0.19.0.7-4; arm64: 11.0.20.0.8-3)
Rocky Linux 8	java-1.8.0-openjdk-devel (amd64: 1.8.0.372.b07-4; arm64: 1.8.0.382.b05-2)
SLES 15	java-17-openjdk-devel (amd64: 17.0.5.0-150400.3.9.3; arm64: 17.0.8.0-150400.3.27.1)
Ubuntu 24.04	default-jdk-headless (amd64, arm64: 2:1.21-75+exp1)
Ubuntu 22.04	default-jdk-headless (amd64, arm64: 2:1.11-72build2)
Ubuntu 20.04	default-jdk-headless (amd64, arm64: 2:1.11-72)

Default port numbers

The following list of open ports per component is applicable for default configuration:

Zabbix component	Port number	Protocol	Type of connection
Zabbix agent	10050	TCP	on demand
Zabbix agent 2	10050	TCP	on demand
Zabbix server	10051	TCP	on demand
Zabbix proxy	10051	TCP	on demand
Zabbix Java gateway	10052	TCP	on demand
Zabbix web service	10053	TCP	on demand
Zabbix frontend	80	HTTP	on demand
	443	HTTPS	on demand
Zabbix trapper	10051	TCP	on demand

Note:

The port numbers should be open in firewall to enable Zabbix communications. Outgoing TCP connections usually do not require explicit firewall settings.

Database size

Zabbix configuration data require a fixed amount of disk space and do not grow much.

Zabbix database size mainly depends on these variables, which define the amount of stored historical data:

- Number of processed values per second

This is the average number of new values Zabbix server receives every second. For example, if we have 3000 items for monitoring with a refresh rate of 60 seconds, the number of values per second is calculated as $3000/60 = 50$.

It means that 50 new values are added to Zabbix database every second.

- Housekeeper settings for history

Zabbix keeps values for a fixed period of time, normally several weeks or months. Each new value requires a certain amount of disk space for data and index.

So, if we would like to keep 30 days of history and we receive 50 values per second, the total number of values will be around $(30*24*3600)* 50 = 129.600.000$, or about 130M of values.

Depending on the database engine used, type of received values (floats, integers, strings, log files, etc), the disk space for keeping a single value may vary from 40 bytes to hundreds of bytes. Normally it is around 90 bytes per value for numeric items². In our case, it means that 130M of values will require $130M * 90 \text{ bytes} = 10.9GB$ of disk space.

Note:

The size of text/log item values is impossible to predict exactly, but you may expect around 500 bytes per value.

- Housekeeper setting for trends

Zabbix keeps a 1-hour max/min/avg/count set of values for each item in the table **trends**. The data is used for trending and long period graphs. The one hour period can not be customized.

Zabbix database, depending on the database type, requires about 90 bytes per each total. Suppose we would like to keep trend data for 5 years. Values for 3000 items will require $3000*24*365* 90 = 2.2GB$ per year, or **11GB** for 5 years.

- Housekeeper settings for events

Each Zabbix event requires approximately 250 bytes of disk space¹. It is hard to estimate the number of events generated by Zabbix daily. In the worst-case scenario, we may assume that Zabbix generates one event per second.

For each recovered event, an event_recovery record is created. Normally most of the events will be recovered so we can assume one event_recovery record per event. That means additional 80 bytes per event.

Optionally events can have tags, each tag record requiring approximately 100 bytes of disk space¹. The number of tags per event (#tags) depends on configuration. So each will need an additional #tags * 100 bytes of disk space.

It means that if we want to keep 3 years of events, this would require $3*365*24*3600* (250+80+ \#tags*100) = \sim 30GB + \#tags*100B$ disk space².

Note:

¹ More when having non-ASCII event names, tags and values.

² The size approximations are based on MySQL and might be different for other databases.

The table contains formulas that can be used to calculate the disk space required for Zabbix system:

Parameter	Formula for required disk space (in bytes)
<i>Zabbix configuration History</i>	Fixed size. Normally 10MB or less. $\text{days} * (\text{items} / \text{refresh rate}) * 24 * 3600 * \text{bytes}$ items : number of items days : number of days to keep history refresh rate : average refresh rate of items bytes : number of bytes required to keep single value, depends on database engine, normally ~90 bytes.
<i>Trends</i>	$\text{days} * (\text{items} / 3600) * 24 * 3600 * \text{bytes}$ items : number of items days : number of days to keep history bytes : number of bytes required to keep single trend, depends on the database engine, normally ~90 bytes.

Parameter	Formula for required disk space (in bytes)
Events	$days * events * 24 * 3600 * bytes$ events : number of event per second. One (1) event per second in worst-case scenario. days : number of days to keep history bytes : number of bytes required to keep single trend, depends on the database engine, normally ~330 + average number of tags per event * 100 bytes.

So, the total required disk space can be calculated as:

Configuration + History + Trends + Events

The disk space will NOT be used immediately after Zabbix installation. Database size will grow then it will stop growing at some point, which depends on housekeeper settings.

Time synchronization

It is very important to have precise system time on the server with Zabbix running. [ntpd](#) is the most popular daemon that synchronizes the host's time with the time of other machines. It's strongly recommended to maintain synchronized system time on all systems Zabbix components are running on.

Network requirements

A following list of open ports per component is applicable for default configuration.

Port	Components
Frontend	http on 80, https on 443
Server	10051 (for use with active proxy/agents)
Active Proxy	10051
Passive Proxy	10051
Agent2	10050
Trapper	
JavaGateway	10052
WebService	10053

Note:

The port numbers should be opened in the firewall to enable external communications with Zabbix. Outgoing TCP connections usually do not require explicit firewall settings.

1 PostgreSQL plugin dependencies

Overview

The required libraries for the PostgreSQL loadable plugin are listed in this page.

Go libraries

Requirement	Mandatory status	Minimum version	Description
git.zabbix.com/ap/plugin-support	Yes	1.X.X	Zabbix own support library. Mostly for plugins.
github.com/jackc/pgx/v4		4.17.2	PostgreSQL driver.
github.com/omeid/go-yarn		0.0.1	Embeddable filesystem mapped key-string store.
github.com/jackc/chunkedio	Indirect ¹	2.0.1	
github.com/jackc/pgconn		1.13.0	
github.com/jackc/pgio		1.0.0	
github.com/jackc/pgpassfile		1.0.0	
github.com/jackc/pgproto3		2.3.1	
github.com/jackc/pgservicefile		0.0.0	
github.com/jackc/pgtype		1.12.0	
github.com/jackc/puddle		1.3.0	
github.com/Microsoft/go-winio		0.6.0	Required package for PostgreSQL plugin on Windows.

Requirement	Mandatory status	Minimum version	Description
golang.org/x/crypto		0.0.0	
golang.org/x/sys		0.0.0	
golang.org/x/text		0.3.7	

¹ "Indirect" means that it is used in one of the libraries that the agent uses. It's required since Zabbix uses the library that uses the package.

2 MongoDB plugin dependencies

Overview

The required libraries for the MongoDB loadable plugin are listed in this page.

Go libraries

Requirement	Mandatory status	Minimum version	Description
git.zabbix.com/ap/plugin/support	Yes	1.X.X	Zabbix own support library. Mostly for plugins.
go.mongodb.org/mongo-driver		1.7.6	Named read/write locks, access sync.
github.com/go-stack/stack	Indirect ¹	1.8.0	Required package for MongoDB plugin mongo-driver lib.
github.com/golang/snappy		0.0.1	Required package for MongoDB plugin mongo-driver lib.
github.com/klauspost/compress		1.13.6	Required package for MongoDB plugin mongo-driver lib.
github.com/Microsoft/go-winio		0.6.0	Required package for MongoDB plugin mongo-driver lib on Windows.
github.com/pkg/errors		0.9.1	Required package for MongoDB plugin mongo-driver lib.
github.com/xdg-go/pbkdf2		1.0.0	Required package for MongoDB plugin mongo-driver lib.
github.com/xdg-go/scram		1.0.2	Required package for MongoDB plugin mongo-driver lib.
github.com/xdg-go/stringprep		1.0.2	Required package for MongoDB plugin mongo-driver lib.
github.com/youmark/pkcs8		0.0.0	Required package for MongoDB plugin mongo-driver lib.
golang.org/x/crypto		0.0.0	Required package for MongoDB plugin mongo-driver lib.
golang.org/x/sync		0.0.0	Required package for MongoDB plugin mongo-driver lib.
golang.org/x/sys		0.0.0	Required package for MongoDB plugin mongo-driver lib.
golang.org/x/text		0.3.7	Required package for MongoDB plugin mongo-driver lib.

¹ "Indirect" means that it is used in one of the libraries that the agent uses. It's required since Zabbix uses the library that uses the package.

3 Installation from sources

You can get the very latest version of Zabbix by compiling it from the sources.

A step-by-step tutorial for installing Zabbix from the sources is provided here.

1 Installing Zabbix daemons

1 Download the source archive

Go to the [Zabbix download page](#) and download the source archive. Once downloaded, extract the sources, by running:

```
tar -zxvf zabbix-7.2.0.tar.gz
```

Note:

Enter the correct Zabbix version in the command. It must match the name of the downloaded archive.

2 Create user account

For all of the Zabbix daemon processes, an unprivileged user is required. If a Zabbix daemon is started from an unprivileged user account, it will run as that user.

However, if a daemon is started from a 'root' account, it will switch to a 'zabbix' user account, which must be present. To create such a user account (in its own group, "zabbix"),

on a RedHat-based system, run:

```
groupadd --system zabbix
useradd --system -g zabbix -d /usr/lib/zabbix -s /sbin/nologin -c "Zabbix Monitoring System" zabbix
```

on a Debian-based system, run:

```
addgroup --system --quiet zabbix
adduser --quiet --system --disabled-login --ingroup zabbix --home /var/lib/zabbix --no-create-home zabbix
```

Attention:

Zabbix processes do not need a home directory, which is why we do not recommend creating it. However, if you are using some functionality that requires it (e. g. store MySQL credentials in `$HOME/.my.cnf`) you are free to create it using the following commands.

On RedHat-based systems, run:

```
mkdir -m u=rwx,g=rwx,o= -p /usr/lib/zabbix
chown zabbix:zabbix /usr/lib/zabbix
```

On Debian-based systems, run:

```
mkdir -m u=rwx,g=rwx,o= -p /var/lib/zabbix
chown zabbix:zabbix /var/lib/zabbix
```

A separate user account is not required for Zabbix frontend installation.

If Zabbix **server** and **agent** are run on the same machine it is recommended to use a different user for running the server than for running the agent. Otherwise, if both are run as the same user, the agent can access the server configuration file and any Admin level user in Zabbix can quite easily retrieve, for example, the database password.

Attention:

Running Zabbix as `root`, `bin`, or any other account with special rights is a security risk.

3 Create Zabbix database

For Zabbix **server** and **proxy** daemons, as well as Zabbix frontend, a database is required. It is not needed to run Zabbix **agent**.

SQL **scripts are provided** for creating database schema and inserting the dataset. Zabbix proxy database needs only the schema while Zabbix server database requires also the dataset on top of the schema.

Having created a Zabbix database, proceed to the following steps of compiling Zabbix.

4 Configure the sources

C99 with GNU extensions is required for building Zabbix server, Zabbix proxy or Zabbix agent. This version can be explicitly specified by setting `CFLAGS="-std=gnu99"`:

```
export CFLAGS="-std=gnu99"
```

Note:

If installing from [Zabbix Git repository](#), it is required to run first:

```
./bootstrap.sh
```

When configuring the sources for a Zabbix server or proxy, you must specify the database type to be used. Only one database type can be compiled with a server or proxy process at a time.

To see all of the supported configuration options, inside the extracted Zabbix source directory run:

```
./configure --help
```

To configure the sources for a Zabbix server and agent, you may run something like:

```
./configure --enable-server --enable-agent --with-mysql --enable-ipv6 --with-net-snmp --with-libcurl --with-
```

To configure the sources for a Zabbix server (with PostgreSQL etc.), you may run:

```
./configure --enable-server --with-postgresql --with-net-snmp
```

To configure the sources for a Zabbix proxy (with SQLite etc.), you may run:

```
./configure --prefix=/usr --enable-proxy --with-net-snmp --with-sqlite3 --with-ssh2
```

To configure the sources for a Zabbix agent, you may run:

```
./configure --enable-agent
```

or, for Zabbix agent 2:

```
./configure --enable-agent2
```

Note:

A configured Go environment with a currently supported [Go version](#) is required for building Zabbix agent 2. See [go.dev](#) for installation instructions.

Notes on compilation options:

- Command-line utilities `zabbix_get` and `zabbix_sender` are compiled if `--enable-agent` option is used.
- `--with-libcurl` and `--with-libxml2` configuration options are required for virtual machine monitoring; `--with-libcurl` is also required for SMTP authentication and `web.page.*` Zabbix agent *items*. Note that cURL 7.20.0 or higher is **required** with the `--with-libcurl` configuration option.
- Zabbix always compiles with the PCRE library; installing it is not optional. `--with-libpcre=[DIR]` only allows pointing to a specific base install directory, instead of searching through a number of common places for the `libpcre` files.
- You may use the `--enable-static` flag to statically link libraries. If you plan to distribute compiled binaries among different servers, you must use this flag to make these binaries work without required libraries. Note that `--enable-static` does not work in [Solaris](#).
- Using `--enable-static` option is not recommended when building server. In order to build the server statically, you must have a static version of every external library needed. There is no strict check for that in `configure` script.
- Add optional path to the MySQL configuration file `--with-mysql=/<path_to_the_file>/mysql_config` to select the desired MySQL client library when there is a need to use one that is not located in the default location. It is useful when there are several versions of MySQL installed or MariaDB installed alongside MySQL on the same system.

Attention:

If `./configure` fails due to missing libraries or some other circumstance, please see the `config.log` file for more details on the error. For example, if `libssl` is missing, the immediate error message may be misleading:

```
checking for main in -lmysqlclient... no
configure: error: Not found mysqlclient library
```

While `config.log` has a more detailed description:

```
/usr/bin/ld: cannot find -lssl
/usr/bin/ld: cannot find -lcrypto
```

See also:

- [Compiling Zabbix with encryption support](#) for encryption support
- [Known issues](#) with compiling Zabbix agent on HP-UX

5 Make and install everything

Note:

If installing from [Zabbix Git repository](#), it is required to run first:

```
$ make dbschema
```

`make install`

This step should be run as a user with sufficient permissions (commonly 'root', or by using `sudo`).

Running `make install` will by default install the daemon binaries (`zabbix_server`, `zabbix_agentd`, `zabbix_proxy`) in `/usr/local/sbin` and the client binaries (`zabbix_get`, `zabbix_sender`) in `/usr/local/bin`.

Note:

To specify a different location than `/usr/local`, use a `--prefix` key in the previous step of configuring sources, for example `--prefix=/home/zabbix`. In this case daemon binaries will be installed under `<prefix>/sbin`, while utilities under `<prefix>/bin`. Man pages will be installed under `<prefix>/share`.

6 Review and edit configuration files

- edit the Zabbix agent configuration file `/usr/local/etc/zabbix_agentd.conf`

You need to configure this file for every host with `zabbix_agentd` installed.

You must specify the Zabbix server **IP address** in the file. Connections from other hosts will be denied.

- edit the Zabbix server configuration file `/usr/local/etc/zabbix_server.conf`

You must specify the database name, user and password (if using any).

The rest of the parameters will suit you with their defaults if you have a small installation (up to ten monitored hosts). You should change the default parameters if you want to maximize the performance of Zabbix server (or proxy) though.

- if you have installed a Zabbix proxy, edit the proxy configuration file `/usr/local/etc/zabbix_proxy.conf`

You must specify the server IP address and proxy hostname (must be known to the server), as well as the database name, user and password (if using any).

Note:

With SQLite the full path to database file must be specified; DB user and password are not required.

7 Start up the daemons

Run `zabbix_server` on the server side.

```
zabbix_server
```

Note:

Make sure that your system allows allocation of 36MB (or a bit more) of shared memory, otherwise the server may not start and you will see "Cannot allocate shared memory for <type of cache>." in the server log file. This may happen on FreeBSD, Solaris 8.

Run `zabbix_agentd` on all the monitored machines.

```
zabbix_agentd
```

Note:

Make sure that your system allows allocation of 2MB of shared memory, otherwise the agent may not start and you will see "Cannot allocate shared memory for collector." in the agent log file. This may happen on Solaris 8.

If you have installed Zabbix proxy, run `zabbix_proxy`.

```
zabbix_proxy
```

2 Installing Zabbix web interface

Copying PHP files

Zabbix frontend is written in PHP, so to run it a PHP supported webserver is needed. Installation is done by simply copying the PHP files from the `ui` directory to the webserver HTML documents directory.

Common locations of HTML documents directories for Apache web servers include:

- `/usr/local/apache2/htdocs` (default directory when installing Apache from source)
- `/srv/www/htdocs` (OpenSUSE, SLES)
- `/var/www/html` (Debian, Ubuntu, Fedora, RHEL)

It is suggested to use a subdirectory instead of the HTML root. To create a subdirectory and copy Zabbix frontend files into it, execute the following commands, replacing the actual directory:

```
mkdir <htdocs>/zabbix
cd ui
cp -a . <htdocs>/zabbix
```

If planning to use any other language than English, see [Installation of additional frontend languages](#) for instructions.

Installing frontend

Please see [Web interface installation](#) page for information about Zabbix frontend installation wizard.

3 Installing Java gateway

It is required to install Java gateway only if you want to monitor JMX applications. Java gateway is lightweight and does not require a database.

To install from sources, first [download](#) and extract the source archive.

To compile Java gateway, run the `./configure` script with `--enable-java` option. It is advisable that you specify the `--prefix` option to request installation path other than the default `/usr/local`, because installing Java gateway will create a whole directory tree, not just a single executable.

```
./configure --enable-java --prefix=$PREFIX
```

To compile and package Java gateway into a JAR file, run `make`. Note that for this step you will need `javac` and `jar` executables in your path.

```
make
```

Now you have a `zabbix-java-gateway-$VERSION.jar` file in `src/zabbix_java/bin`. If you are comfortable with running Java gateway from `src/zabbix_java` in the distribution directory, then you can proceed to instructions for configuring and running [Java gateway](#). Otherwise, make sure you have enough privileges and run `make install`.

```
make install
```

Proceed to [setup](#) for more details on configuring and running Java gateway.

4 Installing Zabbix web service

Installing Zabbix web service is only required if you want to use [scheduled reports](#).

To install from sources, first [download](#) and extract the source archive.

To compile Zabbix web service, run the `./configure` script with `--enable-webservice` option.

Note:

A configured [Go](#) version 1.13+ environment is required for building Zabbix web service.

Run `zabbix_web_service` on the machine, where the web service is installed:

```
zabbix_web_service
```

Proceed to [setup](#) for more details on configuring Scheduled reports generation.

1 Building Zabbix agent on Windows

Overview

This section demonstrates how to build Zabbix Windows agent binaries from sources with or without TLS.

Compiling OpenSSL

The following steps will help you to compile OpenSSL from sources on MS Windows 10 (64-bit).

1. For compiling OpenSSL you will need on Windows machine:
 1. C compiler (e.g. VS 2017 RC),
 2. NASM (<https://www.nasm.us/>),
 3. Perl (e.g. Strawberry Perl from <http://strawberryperl.com/>),
 4. Perl module `Text::Template` (`cpan Text::Template`).
2. Get OpenSSL sources from <https://www.openssl.org/>. OpenSSL 1.1.1 is used here.
3. Unpack OpenSSL sources, for example, in `E:\openssl-1.1.1`.
4. Open a commandline window e.g. the x64 Native Tools Command Prompt for VS 2017 RC.
5. Go to the OpenSSL source directory, e.g. `E:\openssl-1.1.1`.
 1. Verify that NASM can be found:

```
e:\openssl-1.1.1> nasm --version      NASM version 2.13.01 compiled
on May  1 2017
```
6. Configure OpenSSL, for example:

```
e:\openssl-1.1.1> perl E:\openssl-1.1.1\Configure VC-WIN64A no-shared
no-capieng no-srp no-gost no-dgram no-dtls1-method no-dtls1_2-method --api=1.1.0 --prefix=C:\OpenSSL
--openssldir=C:\OpenSSL-Win64-111-static
```

- Note the option 'no-shared': if 'no-shared' is used then the OpenSSL static libraries libcrypto.lib and libssl.lib will be 'self-sufficient' and resulting Zabbix binaries will include OpenSSL in themselves, no need for external OpenSSL DLLs. Advantage: Zabbix binaries can be copied to other Windows machines without OpenSSL libraries. Disadvantage: when a new OpenSSL bugfix version is released, Zabbix agent needs to be recompiled and reinstalled.
- If 'no-shared' is not used, then the static libraries libcrypto.lib and libssl.lib will be using OpenSSL DLLs at runtime. Advantage: when a new OpenSSL bugfix version is released, probably you can upgrade only OpenSSL DLLs, without recompiling Zabbix agent. Disadvantage: copying Zabbix agent to another machine requires copying OpenSSL DLLs, too.

7. Compile OpenSSL, run tests, install:
`e:\openssl-1.1.1> nmake` `e:\openssl-1.1.1> nmake test` ...
 All tests successful. Files=152, Tests=1152, 501 wallclock secs (0.67 usr + 0.61 sys
 = 1.28 CPU) Result: PASS `e:\openssl-1.1.1> nmake install_sw` installs only software
 components (i.e. libraries, header files, but no documentation). If you want everything, use "nmake install".

Compiling PCRE

1. Download the PCRE or PCRE2 library (<https://pcre.org/>).
2. Extract to directory `E:\pcre2-10.39`.
3. Install CMake from <https://cmake.org/download/>, during install select: and ensure that `cmake\bin` is on your path (tested version 3.9.4).
4. Create a new, empty build directory, preferably a subdirectory of the source dir. For example, `E:\pcre2-10.39\build`.
5. Open a commandline window e.g. the x64 Native Tools Command Prompt for VS 2017 and from that shell environment run `cmake-gui`. Do not try to start Cmake from the Windows Start menu, as this can lead to errors.
6. Enter `E:\pcre2-10.39` and `E:\pcre2-10.39\build` for the source and build directories, respectively.
7. Hit the "Configure" button.
8. When specifying the generator for this project select "NMake Makefiles".
9. Create a new, empty install directory. For example, `E:\pcre2-10.39-install`.
10. The GUI will then list several configuration options. Make sure the following options are selected:
 - **PCRE_SUPPORT_UNICODE_PROPERTIES** ON
 - **PCRE_SUPPORT_UTF** ON
 - **CMAKE_INSTALL_PREFIX** `E:\pcre2-10.39-install`
11. Hit "Configure" again. The adjacent "Generate" button should now be active.
12. Hit "Generate".
13. In the event that errors occur, it is recommended that you delete the CMake cache before attempting to repeat the CMake build process. In the CMake GUI, the cache can be deleted by selecting "File > Delete Cache".
14. The build directory should now contain a usable build system - *Makefile*.
15. Open a commandline window e.g. the x64 Native Tools Command Prompt for VS 2017 and navigate to the *Makefile* mentioned above.
16. Run NMake command: `E:\pcre2-10.39\build> nmake install`

Compiling Zabbix

The following steps will help you to compile Zabbix from sources on MS Windows 10 (64-bit). When compiling Zabbix with/without TLS support the only significant difference is in step 4.

1. On a Linux machine check out the source from git:
`$ git clone https://git.zabbix.com/scm/zbx/zabbix.git`
`$ cd zabbix` `$./bootstrap.sh` `$./configure --enable-agent --enable-ipv6 --prefix=`pwd``
`$ make dbschema` `$ make dist`
2. Copy and unpack the archive, e.g. `zabbix-7.2.0.tar.gz`, on a Windows machine.
3. Let's assume that sources are in `e:\zabbix-7.2.0`. Open a commandline window e.g. the x64 Native Tools Command Prompt for VS 2017 RC. Go to `E:\zabbix-7.2.0\build\win32\project`.
4. Compile `zabbix_get`, `zabbix_sender` and `zabbix_agent`.
 - without TLS: `E:\zabbix-7.2.0\build\win32\project> nmake /K PCRE2INCDIR=E:\pcre2-10.39-install\include PCRE2LIBDIR=E:\pcre2-10.39-install\lib`
 - with TLS: `E:\zabbix-7.2.0\build\win32\project> nmake /K -f Makefile_get TLS=openssl TLSINCDIR=C:\OpenSSL-Win64-111-static\include TLSLIBDIR=C:\OpenSSL-Win64-111-static\lib PCRE2INCDIR=E:\pcre2-10.39-install\include PCRE2LIBDIR=E:\pcre2-10.39-install\lib`
`E:\zabbix-7.2.0\build\win32\project> nmake /K -f Makefile_sender TLS=openssl TLSINCDIR="C:\OpenSSL-Win64-111-static\include TLSLIBDIR="C:\OpenSSL-Win64-111-static\lib PCRE2INCDIR=E:\pcre2-10.39-install\include PCRE2LIBDIR=E:\pcre2-10.39-install\lib`
`E:\zabbix-7.2.0\build\win32\project> nmake /K -f Makefile_agent TLS=openssl TLSINCDIR=C:\OpenSSL-Win64-111-static\include TLSLIBDIR=C:\OpenSSL-Win64-111-static\lib PCRE2INCDIR=E:\pcre2-10.39-install\include PCRE2LIBDIR=E:\pcre2-10.39-install\lib`
5. New binaries are located in `e:\zabbix-7.2.0\bin\win64`. Since OpenSSL was compiled with 'no-shared' option, Zabbix binaries contain OpenSSL within themselves and can be copied to other machines that do not have OpenSSL.

Compiling Zabbix with LibreSSL

The process is similar to compiling with OpenSSL, but you need to make small changes in files located in the `build\win32\project` directory:

- In `Makefile_tls` delete `/DHAVE_OPENSSL_WITH_PSK`, i.e. find:

```
CFLAGS = $(CFLAGS) /DHAVE_OPENSSL /DHAVE_OPENSSL_WITH_PSK
```

and replace it with

```
CFLAGS = $(CFLAGS) /DHAVE_OPENSSL
```

- In `Makefile_common.inc` add `/NODEFAULTLIB:LIBCMT` i.e. find:

```
/MANIFESTUAC:"level='asInvoker' uiAccess='false'" /DYNAMICBASE:NO /PDB:$(TARGETDIR)\$(TARGETNAME).pdb
```

and replace it with

```
/MANIFESTUAC:"level='asInvoker' uiAccess='false'" /DYNAMICBASE:NO /PDB:$(TARGETDIR)\$(TARGETNAME).pdb /NODEFAULTLIB:LIBCMT
```

2 Building Zabbix agent 2 on Windows

Overview

This section demonstrates how to build Zabbix agent 2 (Windows) from sources.

Installing MinGW Compiler

1. Download MinGW-w64 with SJLJ (set jump/long jump) Exception Handling and Windows threads (for example `x86_64-8.1.0-release-win32-sjlj-rt_v6-rev0.7z`)
2. Extract and move to `c:\mingw`
3. Setup environmental variable

```
@echo off
set PATH=%PATH%;c:\mingw\bin
cmd
```

When compiling use Windows prompt instead of MSYS terminal provided by MinGW

Compiling PCRE development libraries

The following instructions will compile and install 64-bit PCRE libraries in `c:\dev\pcre` and 32-bit libraries in `c:\dev\pcre32`:

1. Download the PCRE or PCRE2 library (<https://pcre.org/>) and extract
2. Open `cmd` and navigate to the extracted sources

Build 64bit PCRE

1. Delete old configuration/cache if exists:

```
del CMakeCache.txt
rmdir /q /s CMakeFiles
```

2. Run `cmake` (CMake can be installed from <https://cmake.org/download/>):

```
cmake -G "MinGW Makefiles" -DCMAKE_C_COMPILER=gcc -DCMAKE_C_FLAGS="-O2 -g" -DCMAKE_CXX_FLAGS="-O2 -g" -DCMAKE_CXX_COMPILER=g++
```

3. Next, run:

```
mingw32-make clean
mingw32-make install
```

Build 32bit PCRE

1. Run:

```
mingw32-make clean
```

2. Delete `CMakeCache.txt`:

```
del CMakeCache.txt
rmdir /q /s CMakeFiles
```

3. Run `cmake`:

```
cmake -G "MinGW Makefiles" -DCMAKE_C_COMPILER=gcc -DCMAKE_C_FLAGS="-m32 -O2 -g" -DCMAKE_CXX_FLAGS="-m32 -g" -DCMAKE_CXX_COMPILER=g++
```

4. Next, run:

```
mingw32-make install
```

Installing OpenSSL development libraries

1. Download 32 and 64 bit builds from <https://curl.se/windows/>
2. Extract files into `c:\dev\openssl32` and `c:\dev\openssl` directories accordingly.
3. After that remove extracted `*.dll.a` (dll call wrapper libraries) as MinGW prioritizes them before static libraries.

Compiling Zabbix agent 2

32 bit

Open MinGW environment (Windows command prompt) and navigate to `build/mingw` directory in the Zabbix source tree.

Run:

```
mingw32-make clean
mingw32-make ARCH=x86 PCRE=c:\dev\pcre32 OPENSSSL=c:\dev\openssl32
```

64 bit

Open MinGW environment (Windows command prompt) and navigate to `build/mingw` directory in the Zabbix source tree.

Run:

```
mingw32-make clean
mingw32-make PCRE=c:\dev\pcre OPENSSSL=c:\dev\openssl
```

Note:

Both 32- and 64- bit versions can be built on a 64-bit platform, but only a 32-bit version can be built on a 32-bit platform. When working on the 32-bit platform, follow the same steps as for 64-bit version on 64-bit platform.

3 Building Zabbix agent on macOS

Overview

This section demonstrates how to build Zabbix macOS agent binaries from sources with or without TLS.

Prerequisites

You will need command line developer tools (Xcode is not required), Automake, pkg-config and PCRE (v8.x) or PCRE2 (v10.x). If you want to build agent binaries with TLS, you will also need OpenSSL or GnuTLS.

To install Automake and pkg-config, you will need a Homebrew package manager from <https://brew.sh/>. To install it, open terminal and run the following command:

```
/usr/bin/ruby -e "$(curl -fsSL https://raw.githubusercontent.com/Homebrew/install/master/install)"
```

Then install Automake and pkg-config:

```
brew install automake
brew install pkg-config
```

Preparing PCRE, OpenSSL and GnuTLS libraries depends on the way how they are going to be linked to the agent.

If you intend to run agent binaries on a macOS machine that already has these libraries, you can use precompiled libraries that are provided by Homebrew. These are typically macOS machines that use Homebrew for building Zabbix agent binaries or for other purposes.

If agent binaries will be used on macOS machines that don't have the shared version of libraries, you should compile static libraries from sources and link Zabbix agent with them.

Building agent binaries with shared libraries

Install PCRE2 (replace `pcre2` with `pcre` in the commands below, if needed):

```
brew install pcre2
```

When building with TLS, install OpenSSL and/or GnuTLS:

```
brew install openssl
brew install gnutls
```

Download Zabbix source:

```
git clone https://git.zabbix.com/scm/zbx/zabbix.git
```

Build agent without TLS:

```
cd zabbix
./bootstrap.sh
./configure --sysconfdir=/usr/local/etc/zabbix --enable-agent --enable-ipv6
make
make install
```

Build agent with OpenSSL:

```
cd zabbix
./bootstrap.sh
./configure --sysconfdir=/usr/local/etc/zabbix --enable-agent --enable-ipv6 --with-openssl=/usr/local/opt/openssl
make
make install
```

Build agent with GnuTLS:

```
cd zabbix-source/
./bootstrap.sh
./configure --sysconfdir=/usr/local/etc/zabbix --enable-agent --enable-ipv6 --with-gnutls=/usr/local/opt/gnutls
make
make install
```

Building agent binaries with static libraries without TLS

Let's assume that PCRE static libraries will be installed in `$HOME/static-libs`. We will use PCRE2 10.39.

```
PCRE_PREFIX="$HOME/static-libs/pcre2-10.39"
```

Download and build PCRE with Unicode properties support:

```
mkdir static-libs-source
cd static-libs-source
curl --remote-name https://github.com/PhilipHazel/pcre2/releases/download/pcre2-10.39/pcre2-10.39.tar.gz
tar xf pcre2-10.39.tar.gz
cd pcre2-10.39
./configure --prefix="$PCRE_PREFIX" --disable-shared --enable-static --enable-unicode-properties
make
make check
make install
```

Download Zabbix source and build agent:

```
git clone https://git.zabbix.com/scm/zbx/zabbix.git
cd zabbix
./bootstrap.sh
./configure --sysconfdir=/usr/local/etc/zabbix --enable-agent --enable-ipv6 --with-libpcre2="$PCRE_PREFIX"
make
make install
```

Building agent binaries with static libraries with OpenSSL

When building OpenSSL, it's recommended to run `make test` after successful building. Even if building was successful, tests sometimes fail. If this is the case, problems should be researched and resolved before continuing.

Let's assume that PCRE and OpenSSL static libraries will be installed in `$HOME/static-libs`. We will use PCRE2 10.39 and OpenSSL 1.1.1a.

```
PCRE_PREFIX="$HOME/static-libs/pcre2-10.39"
OPENSSL_PREFIX="$HOME/static-libs/openssl-1.1.1a"
```

Let's build static libraries in `static-libs-source`:

```
mkdir static-libs-source
cd static-libs-source
```

Download and build PCRE with Unicode properties support:

```
curl --remote-name https://github.com/PhilipHazel/pcre2/releases/download/pcre2-10.39/pcre2-10.39.tar.gz
tar xf pcre2-10.39.tar.gz
```

```
cd pcre2-10.39
./configure --prefix="$PCRE_PREFIX" --disable-shared --enable-static --enable-unicode-properties
make
make check
make install
cd ..
```

Download and build OpenSSL:

```
curl --remote-name https://www.openssl.org/source/openssl-1.1.1a.tar.gz
tar xf openssl-1.1.1a.tar.gz
cd openssl-1.1.1a
./Configure --prefix="$OPENSSL_PREFIX" --openssldir="$OPENSSL_PREFIX" --api=1.1.0 no-shared no-capieng no-
make
make test
make install_sw
cd ..
```

Download Zabbix source and build agent:

```
git clone https://git.zabbix.com/scm/zbx/zabbix.git
cd zabbix
./bootstrap.sh
./configure --sysconfdir=/usr/local/etc/zabbix --enable-agent --enable-ipv6 --with-libpcre2="$PCRE_PREFIX"
make
make install
```

Building agent binaries with static libraries with GnuTLS

GnuTLS depends on the Nettle crypto backend and GMP arithmetic library. Instead of using full GMP library, this guide will use mini-gmp which is included in Nettle.

When building GnuTLS and Nettle, it's recommended to run `make check` after successful building. Even if building was successful, tests sometimes fail. If this is the case, problems should be researched and resolved before continuing.

Let's assume that PCRE, Nettle and GnuTLS static libraries will be installed in `$HOME/static-libs`. We will use PCRE2 10.39, Nettle 3.4.1 and GnuTLS 3.6.5.

```
PCRE_PREFIX="$HOME/static-libs/pcre2-10.39"
NETTLE_PREFIX="$HOME/static-libs/nettle-3.4.1"
GNUTLS_PREFIX="$HOME/static-libs/gnutls-3.6.5"
```

Let's build static libraries in `static-libs-source`:

```
mkdir static-libs-source
cd static-libs-source
```

Download and build Nettle:

```
curl --remote-name https://ftp.gnu.org/gnu/nettle/nettle-3.4.1.tar.gz
tar xf nettle-3.4.1.tar.gz
cd nettle-3.4.1
./configure --prefix="$NETTLE_PREFIX" --enable-static --disable-shared --disable-documentation --disable-a
make
make check
make install
cd ..
```

Download and build GnuTLS:

```
curl --remote-name https://www.gnupg.org/ftp/gcrypt/gnutls/v3.6/gnutls-3.6.5.tar.xz
tar xf gnutls-3.6.5.tar.xz
cd gnutls-3.6.5
PKG_CONFIG_PATH="$NETTLE_PREFIX/lib/pkgconfig" ./configure --prefix="$GNUTLS_PREFIX" --enable-static --dis
make
make check
make install
cd ..
```

Download Zabbix source and build agent:

```
git clone https://git.zabbix.com/scm/zbx/zabbix.git
cd zabbix
./bootstrap.sh
CFLAGS="-Wno-unused-command-line-argument -framework Foundation -framework Security" \
> LIBS="-lgnutls -lhogweed -lnettle" \
> LDFLAGS="-L$GNUTLS_PREFIX/lib -L$NETTLE_PREFIX/lib" \
> ./configure --sysconfdir=/usr/local/etc/zabbix --enable-agent --enable-ipv6 --with-libpcre2="$PCRE_PREFIX"
make
make install
```

4 Installation from packages

Zabbix SIA provides official RPM and DEB packages for:

- [Red Hat Enterprise Linux and derivatives](#)
- [Debian/Ubuntu/Raspbian](#)
- [SUSE Linux Enterprise Server](#)

Package files for yum/dnf, apt, and zypper repositories for various OS distributions are available in the [Zabbix official repository](#).

Some OS distributions (in particular, Debian-based distributions) provide their own Zabbix packages. Note that these packages are **not** supported by Zabbix. Third-party Zabbix packages can be out of date and may lack the latest features and bug fixes. It is recommended to use only the packages from the [Zabbix official repository](#). If you have previously used unofficial Zabbix packages, see notes about [upgrading the Zabbix packages from OS repositories](#).

1 Red Hat Enterprise Linux and derivatives

Overview

Official Zabbix 7.2 PRE-RELEASE packages for Red Hat Enterprise Linux as well as for AlmaLinux, Oracle Linux, Rocky Linux, AmazonLinux, and CentOS are available on [Zabbix website](#). Note that Zabbix 7.2 is not released yet and provided packages are for the Zabbix version that is currently being developed.

Attention:

Zabbix packages for Red Hat Enterprise Linux systems are intended only for RHEL systems. Alternative environments, such as [Red Hat Universal Base Image](#), may lack the necessary dependencies and repository access requirements for successful installation. To address such issues, verify compatibility with the target environment and ensure access to required repositories and dependencies before proceeding with Zabbix installation from packages. For more information, see [Known issues](#).

Packages are available with:

- MySQL or PostgreSQL database
- Apache or Nginx web server support

Zabbix agent packages, as well as *Zabbix get* and *Zabbix sender* utilities are also available in Zabbix Official Repository as [7.2 pre-release versions](#) for the following OS:

- RHEL 7, 8, and 9
- AlmaLinux 8 and 9
- AmazonLinux 2023
- CentOS Stream 8, 9, and 10
- Oracle Linux 8 and 9
- Rocky Linux 8 and 9

The official Zabbix repository provides *fping*, *iksemel* and *libssh2* packages as well. These packages are located in the [third-party](#) directory.

Attention:

The EPEL repository for EL9 also provides Zabbix packages. If both the official Zabbix repository and EPEL repositories are installed, then the Zabbix packages in EPEL **must be** excluded by adding the following clause to the EPEL repo configuration file under `/etc/yum.repos.d/`:

```
[epel]
...
excludepkgs=zabbix*
```

See also: [Accidental installation of EPEL Zabbix packages](#)

Notes on installation

See [installation instructions](#) per platform in the download page for:

- installing the repository
- installing server/agent/frontend
- creating initial database, importing initial data
- configuring database for Zabbix server
- configuring PHP for Zabbix frontend
- starting server/agent processes
- configuring Zabbix frontend

If you want to run Zabbix agent as root, see [Running agent as root](#).

Zabbix web service process, which is used for [scheduled report generation](#), requires Google Chrome browser. The browser is not included into packages and has to be installed manually.

Importing data with Timescale DB

With TimescaleDB, in addition to the import command for PostgreSQL, also run:

```
cat /usr/share/zabbix-sql-scripts/postgresql/timescaledb/schema.sql | sudo -u zabbix psql zabbix
```

Warning:

TimescaleDB is supported with Zabbix server only.

SELinux configuration

Zabbix uses socket-based inter-process communication. On systems where SELinux is enabled, it may be required to add SELinux rules to allow Zabbix create/use UNIX domain sockets in the SocketDir directory. Currently, socket files are used by server (alerter, preprocessing, IPMI) and proxy (IPMI). Socket files are persistent, meaning they are present while the process is running.

Having SELinux status enabled in enforcing mode, you need to execute the following commands to enable communication between Zabbix frontend and server:

RHEL 7 and later or AlmaLinux, CentOS Stream, Oracle Linux, Rocky Linux 8 and later:

```
setsebool -P httpd_can_connect_zabbix on
```

If the database is accessible over network (including 'localhost' in case of PostgreSQL), you need to allow Zabbix frontend to connect to the database too:

```
setsebool -P httpd_can_network_connect_db on
```

RHEL prior to 7:

```
setsebool -P httpd_can_network_connect on
setsebool -P zabbix_can_network on
```

After the frontend and SELinux configuration is done, restart the Apache web server:

```
systemctl restart httpd
```

Optionally, you can download a pre-defined `zabbix-selinux-policy` package from Zabbix repository. This package is provided for all supported OS versions to speed up Zabbix deployment and configuration and prevent users from turning off SELinux because of the configuration complexity.

Attention:

For maximum security level, it is recommended to set custom SELinux settings.

`zabbix-selinux-policy` package contains a basic default policy for SELinux allowing Zabbix to create and use sockets and enabling HTTPd connection to PostgreSQL (used by frontend). The source `zabbix_policy.te` file contains the following rules:

```
module zabbix_policy 1.2;

require {
    type zabbix_t;
    type zabbix_port_t;
    type zabbix_var_run_t;
    type postgresql_port_t;
    type httpd_t;
    class tcp_socket name_connect;
    class sock_file { create unlink };
    class unix_stream_socket connectto;
}

#===== zabbix_t =====
allow zabbix_t self:unix_stream_socket connectto;
allow zabbix_t zabbix_port_t:tcp_socket name_connect;
allow zabbix_t zabbix_var_run_t:sock_file create;
allow zabbix_t zabbix_var_run_t:sock_file unlink;
allow httpd_t zabbix_port_t:tcp_socket name_connect;

#===== httpd_t =====
allow httpd_t postgresql_port_t:tcp_socket name_connect;
```

Proxy installation

Once the required repository is added, you can install Zabbix proxy by running:

```
dnf install zabbix-proxy-mysql zabbix-sql-scripts
```

Substitute 'mysql' in the commands with 'pgsql' to use PostgreSQL, or with 'sqlite3' to use SQLite3 (proxy only).

The package 'zabbix-sql-scripts' contains database schemas for all supported database management systems for both Zabbix server and Zabbix proxy and will be used for data import.

Creating database

Create a separate database for Zabbix proxy.

Zabbix server and Zabbix proxy cannot use the same database. If they are installed on the same host, the proxy database must have a different name.

Importing data

Import initial schema:

```
cat /usr/share/zabbix-sql-scripts/mysql/proxy.sql | mysql -uzabbix -p zabbix
```

For proxy with PostgreSQL (or SQLite):

```
cat /usr/share/zabbix-sql-scripts/postgresql/proxy.sql | sudo -u zabbix psql zabbix
cat /usr/share/zabbix-sql-scripts/sqlite3/proxy.sql | sqlite3 zabbix.db
```

Configure database for Zabbix proxy

Edit Zabbix proxy configuration file (`/etc/zabbix/zabbix_proxy.conf`):

```
DBHost=localhost
DBName=zabbix
DBUser=zabbix
DBPassword=<password>
```

In `DBName` for Zabbix proxy use a separate database from Zabbix server.

In `DBPassword` use Zabbix database password for MySQL; PostgreSQL user password for PostgreSQL.

Use `DBHost=` with PostgreSQL. You might want to keep the default setting `DBHost=localhost` (or an IP address), but this would make PostgreSQL use a network socket for connecting to Zabbix. See [SELinux configuration](#) for instructions.

Starting Zabbix proxy process

To start a Zabbix proxy process and make it start at system boot:

```
systemctl start zabbix-proxy
systemctl enable zabbix-proxy
```

Frontend configuration

A Zabbix proxy does not have a frontend; it communicates with Zabbix server only.

Java gateway installation

It is required to install **Java gateway** only if you want to monitor JMX applications. Java gateway is lightweight and does not require a database.

Once the required repository is added, you can install Zabbix Java gateway by running:

```
dnf install zabbix-java-gateway
```

Proceed to **setup** for more details on configuring and running Java gateway.

Installing debuginfo packages

Debuginfo package is currently available for RHEL 7.

To enable debuginfo repository, edit `/etc/yum.repos.d/zabbix.repo` file. Change `enabled=0` to `enabled=1` for zabbix-debuginfo repository.

```
[zabbix-debuginfo]
name=Zabbix Official Repository debuginfo - $basearch
baseurl=http://repo.zabbix.com/zabbix/7.2/stable/rhel/7/$basearch/debuginfo/
enabled=0
gpgkey=file:///etc/pki/rpm-gpg/RPM-GPG-KEY-ZABBIX-A14FE591
gpgcheck=1
```

This will allow you to install the zabbix-debuginfo package.

```
dnf install zabbix-debuginfo
```

This single package contains debug information for all binary Zabbix components.

2 Debian/Ubuntu/Raspbian

Overview

Official Zabbix 7.2 PRE-RELEASE packages for Debian, Ubuntu, and Raspberry Pi OS (Raspbian) are available on [Zabbix website](#). Note that Zabbix 7.2 is not released yet and provided packages are for the Zabbix version that is currently being developed.

Packages are available with either MySQL/PostgreSQL database and Apache/Nginx web server support.

Notes on installation

See the [installation instructions](#) per platform in the download page for:

- installing the repository
- installing server/agent/frontend
- creating initial database, importing initial data
- configuring database for Zabbix server
- configuring PHP for Zabbix frontend
- starting server/agent processes
- configuring Zabbix frontend

If you want to run Zabbix agent as root, see [running agent as root](#).

Zabbix web service process, which is used for [scheduled report generation](#), requires Google Chrome browser. The browser is not included into packages and has to be installed manually.

Importing data with Timescale DB

With TimescaleDB, in addition to the import command for PostgreSQL, also run:

```
cat /usr/share/zabbix-sql-scripts/postgresql/timescaledb/schema.sql | sudo -u zabbix psql zabbix
```

Warning:

TimescaleDB is supported with Zabbix server only.

SELinux configuration

See [SELinux configuration](#) for RHEL.

After the frontend and SELinux configuration is done, restart the Apache web server:

```
systemctl restart apache2
```

Proxy installation

Once the required repository is added, you can install Zabbix proxy by running:

```
apt install zabbix-proxy-mysql zabbix-sql-scripts
```

Substitute 'mysql' in the command with 'pgsql' to use PostgreSQL, or with 'sqlite3' to use SQLite3.

The package 'zabbix-sql-scripts' contains database schemas for all supported database management systems for both Zabbix server and Zabbix proxy and will be used for data import.

Creating database

Create a separate database for Zabbix proxy.

Zabbix server and Zabbix proxy cannot use the same database. If they are installed on the same host, the proxy database must have a different name.

Importing data

Import initial schema:

```
cat /usr/share/zabbix-sql-scripts/mysql/proxy.sql | mysql -uzabbix -p zabbix
```

For proxy with PostgreSQL (or SQLite):

```
cat /usr/share/zabbix-sql-scripts/postgresql/proxy.sql | sudo -u zabbix psql zabbix
cat /usr/share/zabbix-sql-scripts/sqlite3/proxy.sql | sqlite3 zabbix.db
```

Configure database for Zabbix proxy

Edit Zabbix proxy configuration file (/etc/zabbix/zabbix_proxy.conf):

```
DBHost=localhost
DBName=zabbix
DBUser=zabbix
DBPassword=<password>
```

In DBName for Zabbix proxy use a separate database from Zabbix server.

In DBPassword use Zabbix database password for MySQL; PostgreSQL user password for PostgreSQL.

Use DBHost= with PostgreSQL. You might want to keep the default setting DBHost=localhost (or an IP address), but this would make PostgreSQL use a network socket for connecting to Zabbix. Refer to the [respective section](#) for RHEL for instructions.

Starting Zabbix proxy process

To start a Zabbix proxy process and make it start at system boot:

```
systemctl restart zabbix-proxy
systemctl enable zabbix-proxy
```

Frontend configuration

A Zabbix proxy does not have a frontend; it communicates with Zabbix server only.

Java gateway installation

It is required to install [Java gateway](#) only if you want to monitor JMX applications. Java gateway is lightweight and does not require a database.

Once the required repository is added, you can install Zabbix Java gateway by running:

```
apt install zabbix-java-gateway
```

Proceed to [setup](#) for more details on configuring and running Java gateway.

3 SUSE Linux Enterprise Server

Overview

Official Zabbix 7.2 PRE-RELEASE packages for SUSE Linux Enterprise Server are available on [Zabbix website](#). Note that Zabbix 7.2 is not released yet and provided packages are for the Zabbix version that is currently being developed.

Zabbix agent packages and utilities *Zabbix get* and *Zabbix sender* are available in Zabbix Official Repository for [SLES 15 \(SP4 and newer\)](#) and [SLES 12 \(SP4 and newer\)](#) as 7.2 pre-release versions.

Please note that SLES 12 can be used only for Zabbix proxy and the following features are not available:

- *Verify CA encryption mode* with MySQL does not work due to older MySQL libraries.
- *SSH checks* - due to the older libssh version.

Adding Zabbix repository

Install the repository configuration package. This package contains yum (software package manager) configuration files.

SLES 15:

```
rpm -Uvh --nosignature https://repo.zabbix.com/zabbix/7.2/release/sles/15/noarch/zabbix-release-latest.sles15.noarch.rpm
zypper --gpg-auto-import-keys refresh 'Zabbix Official Repository'
```

SLES 12 (proxy only):

```
rpm -Uvh --nosignature https://repo.zabbix.com/zabbix/7.2/release/sles/12/noarch/zabbix-release-latest.sles12.noarch.rpm
zypper --gpg-auto-import-keys refresh 'Zabbix Official Repository'
```

Please note that Zabbix web service process, which is used for *scheduled report generation*, requires Google Chrome browser. The browser is not included into packages and has to be installed manually.

Server/frontend/agent installation

To install Zabbix server/frontend/agent with PHP 8, Apache and MySQL support, run:

```
zypper install zabbix-server-mysql zabbix-web-mysql zabbix-apache-conf-php8 zabbix-agent
```

Substitute component names in this command as needed:

- **For Nginx:** use `zabbix-nginx-conf-php8` instead of `zabbix-apache-conf-php8`. See also: [Nginx setup for Zabbix on SLES 15](#).
- **For PostgreSQL:** use `zabbix-server-pgsql` instead of `zabbix-server-mysql`; use `zabbix-web-pgsql` instead of `zabbix-web-mysql`.
- **For Zabbix agent 2** (only SLES 15): use `zabbix-agent2` instead of or in addition to `zabbix-agent`.

To install Zabbix proxy with MySQL support:

```
zypper install zabbix-proxy-mysql zabbix-sql-scripts
```

For PostgreSQL, use `zabbix-proxy-pgsql` instead of `zabbix-proxy-mysql`.

For SQLite3, use `zabbix-proxy-sqlite3` instead of `zabbix-proxy-mysql`.

The package 'zabbix-sql-scripts' contains database schemas for all supported database management systems for both Zabbix server and Zabbix proxy and will be used for data import.

Creating database

Zabbix *server* and *proxy* daemons require a database. Zabbix *agent* does not need a database.

To create a database, follow the instructions for [MySQL](#) or [PostgreSQL](#). An SQLite3 database (supported for Zabbix proxy only) will be created automatically and does not require additional installation steps.

Warning:

Separate databases are required for Zabbix server and Zabbix proxy; they cannot share the same database. If a server and a proxy are installed on the same host, their databases must be created with different names!

Importing data

Now import initial schema and data for the **server** with MySQL:

```
zcat /usr/share/packages/zabbix-sql-scripts/mysql/create.sql.gz | mysql -uzabbix -p zabbix
```

You will be prompted to enter your newly created database password.

With PostgreSQL:

```
zcat /usr/share/packages/zabbix-sql-scripts/postgresql/create.sql.gz | sudo -u zabbix psql zabbix
```

With TimescaleDB, in addition to the previous command, also run:

```
zcat /usr/share/packages/zabbix-sql-scripts/postgresql/timescaledb/schema.sql.gz | sudo -u <username> psql
```

Warning:

TimescaleDB is supported with Zabbix server only.

For proxy, import initial schema:

```
zcat /usr/share/packages/zabbix-sql-scripts/mysql/schema.sql.gz | mysql -uzabbix -p zabbix
```

For proxy with PostgreSQL:

```
zcat /usr/share/packages/zabbix-sql-scripts/postgresql/schema.sql.gz | sudo -u zabbix psql zabbix
```

Configure database for Zabbix server/proxy

Edit Zabbix server configuration file (`/etc/zabbix/zabbix_server.conf`) and, if required, Zabbix proxy configuration file (`/etc/zabbix/zabbix_proxy.conf`) for their respective databases. For example:

```
DBHost=localhost
DBName=zabbix
DBUser=zabbix
DBPassword=<password>
```

In `DBPassword` use Zabbix database password for MySQL; PostgreSQL user password for PostgreSQL.

Use `DBHost=` with PostgreSQL. You might want to keep the default setting `DBHost=localhost` (or an IP address), but this would make PostgreSQL use a network socket for connecting to Zabbix.

Zabbix frontend configuration

Depending on the web server used (Apache/Nginx), edit the corresponding configuration file for Zabbix frontend. While some PHP settings may already be configured, it's essential that you uncomment the `date.timezone` setting and specify the appropriate [timezone](#) setting that suits your requirements.

- For Apache the configuration file is located in `/etc/apache2/conf.d/zabbix.conf`.

```
php_value max_execution_time 300
php_value memory_limit 128M
php_value post_max_size 16M
php_value upload_max_filesize 2M
php_value max_input_time 300
php_value max_input_vars 10000
php_value always_populate_raw_post_data -1
# php_value date.timezone Europe/Riga
```

- The `zabbix-nginx-conf` package installs a separate Nginx server for Zabbix frontend. Its configuration file is located in `/etc/nginx/conf.d/zabbix.conf`. For Zabbix frontend to work, it's necessary to uncomment and set `listen` and/or `server_name` directives.

```
# listen 80;
# server_name example.com;
```

- Zabbix uses its own dedicated php-fpm connection pool with Nginx:

Its configuration file is located in `/etc/php8/fpm/php-fpm.d/zabbix.conf` (the path may vary slightly depending on the service pack).

```
php_value[max_execution_time] = 300
php_value[memory_limit] = 128M
php_value[post_max_size] = 16M
php_value[upload_max_filesize] = 2M
php_value[max_input_time] = 300
php_value[max_input_vars] = 10000
; php_value[date.timezone] = Europe/Riga
```

Now you are ready to proceed with **frontend installation steps** that will allow you to access your newly installed Zabbix.

Note that a Zabbix proxy does not have a frontend; it communicates with Zabbix server only.

Starting Zabbix server/agent process

Start Zabbix server and agent processes and make it start at system boot.

With Apache web server:

```
systemctl restart zabbix-server zabbix-agent apache2 php-fpm
systemctl enable zabbix-server zabbix-agent apache2 php-fpm
```

For Nginx, substitute apache2 with nginx.

Installing debuginfo packages

To enable debuginfo repository edit `/etc/zypp/repos.d/zabbix.repo` file. Change `enabled=0` to `enabled=1` for zabbix-debuginfo repository.

```
[zabbix-debuginfo]
name=Zabbix Official Repository debuginfo
type=rpm-md
baseurl=https://repo.zabbix.com/zabbix/7.2/stable/sles/15/x86_64/debuginfo/
gpgcheck=1
gpgkey=https://repo.zabbix.com/zabbix/7.2/stable/sles/15/x86_64/debuginfo/repokey/zabbix.repokey
enabled=0
update=1
```

This will allow you to install zabbix-**<component>**-debuginfo packages.

4 Windows agent installation from MSI

Overview

Zabbix Windows agent can be installed from Windows MSI installer packages (32-bit or 64-bit) available for [download](#).

A 32-bit package cannot be installed on a 64-bit Windows.

The minimum requirement for MSI installation is:

- Windows XP 64-bit and Server 2003 for Zabbix agent;
- Windows 10 32-bit and Server 2016 for Zabbix agent 2.

The Zabbix get and sender utilities can also be installed, either together with Zabbix agent/agent 2 or separately.

All packages come with TLS support, however, configuring TLS is optional.

Both UI and command-line based installation is supported.

Note:

Although Zabbix installation from MSI installer packages is fully supported, it is recommended to install at least *Microsoft .NET Framework 2* for proper error handling. See [Microsoft Download .NET Framework](#).

Attention:

It is recommended to use default paths provided by the installer as using custom paths without proper permissions could compromise the security of the installation.

Installation steps

To install, double-click the downloaded MSI file.



ZABBIX

The Enterprise-class
Monitoring Solution
for Everyone

www.zabbix.com

Welcome to the Zabbix Agent (64-bit) Setup Wizard

The Setup Wizard will install Zabbix Agent (64-bit) on your computer. Click Next to continue or Cancel to exit the Setup Wizard.

Back

Next

Cancel

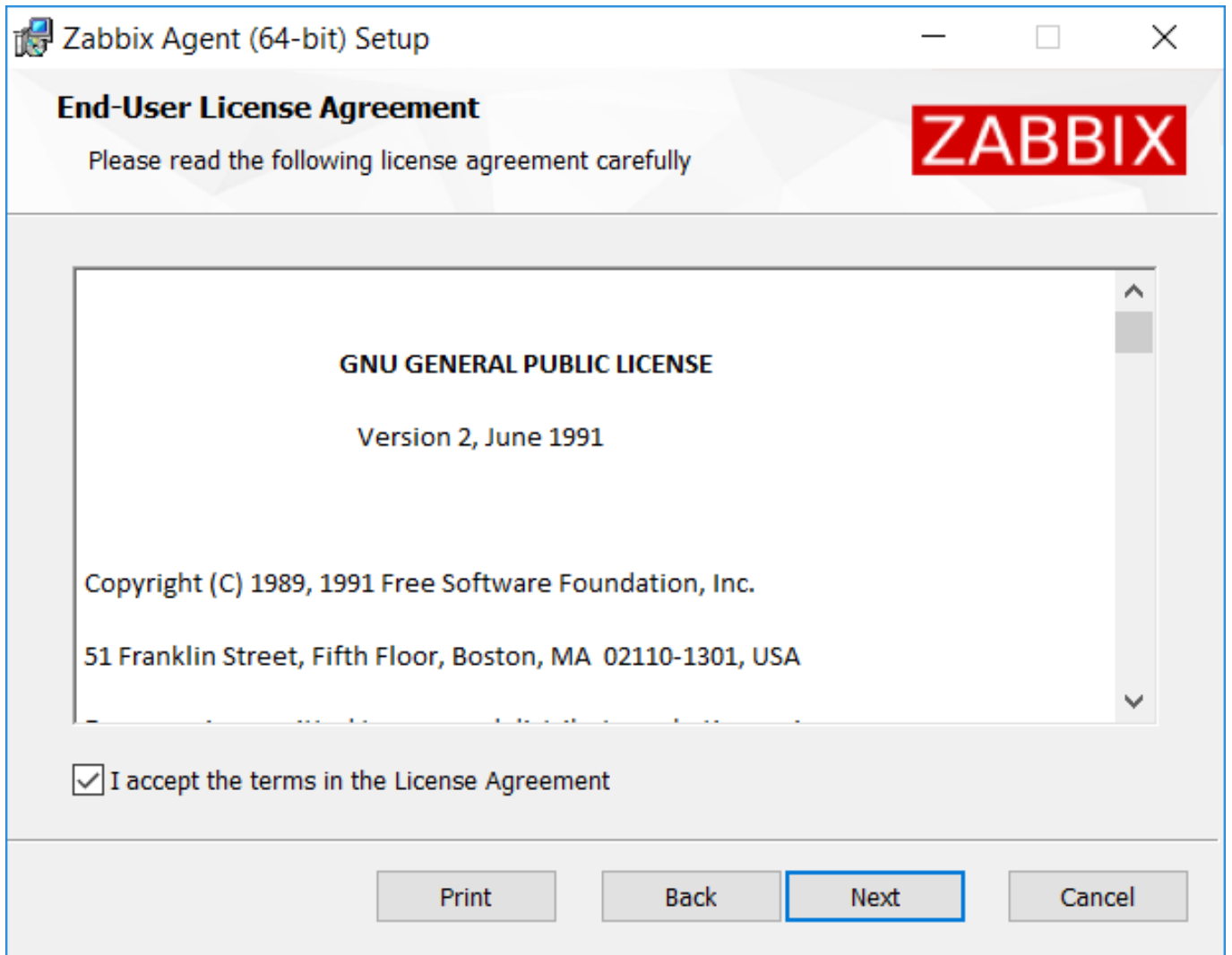

Accept the license to proceed to the next step.

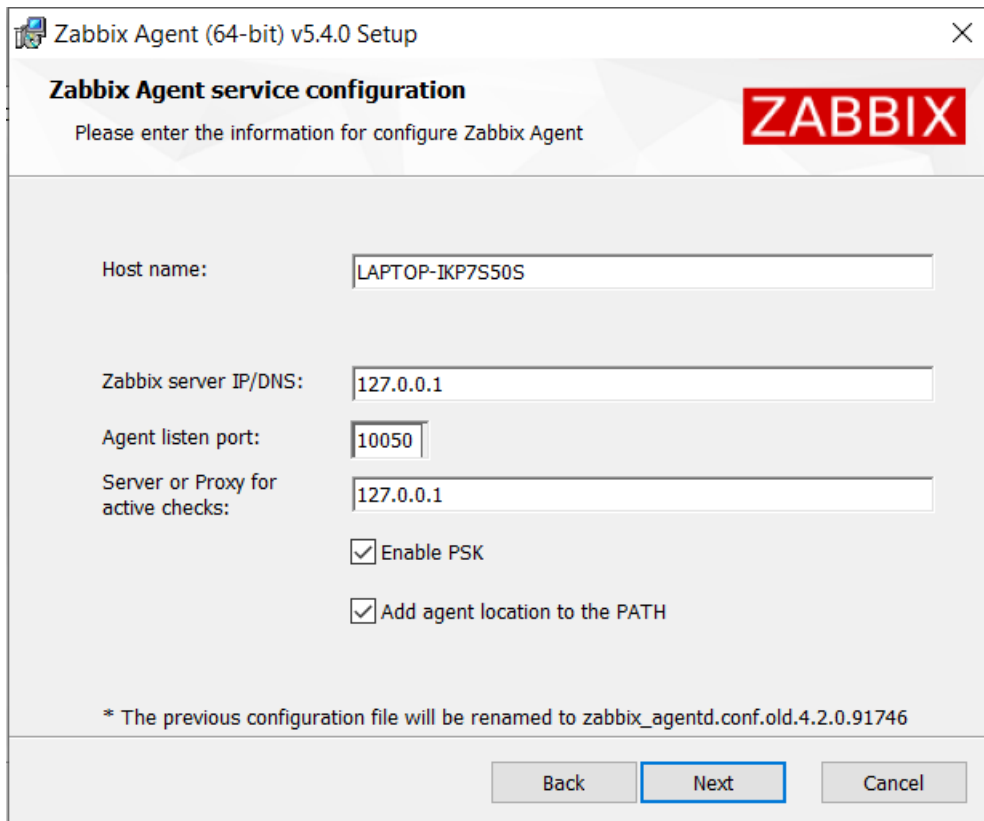

Specify the following parameters.

Parameter	Description
<i>Host name</i>	Specify host name.
<i>Zabbix server IP/DNS</i>	Specify IP/DNS of Zabbix server.
<i>Agent listen port</i>	Specify agent listen port (10050 by default).
<i>Server or Proxy for active checks</i>	Specify IP/DNS of Zabbix server/proxy for active agent checks.
<i>Enable PSK</i>	Mark the checkbox to enable TLS support via pre-shared keys.
<i>Add agent location to the PATH</i>	Add agent location to the PATH variable.

Zabbix Agent (64-bit) PSK Setup

Zabbix Agent pre-shared key configuration 

Please enter the PSK information for configure Zabbix Agent

Pre-shared key identity:

Pre-shared key value:

Please, set minimum required permission to access the psk.key file

Back Next Cancel

Enter pre-shared key identity and value. This step is only available if you checked *Enable PSK* in the previous step.

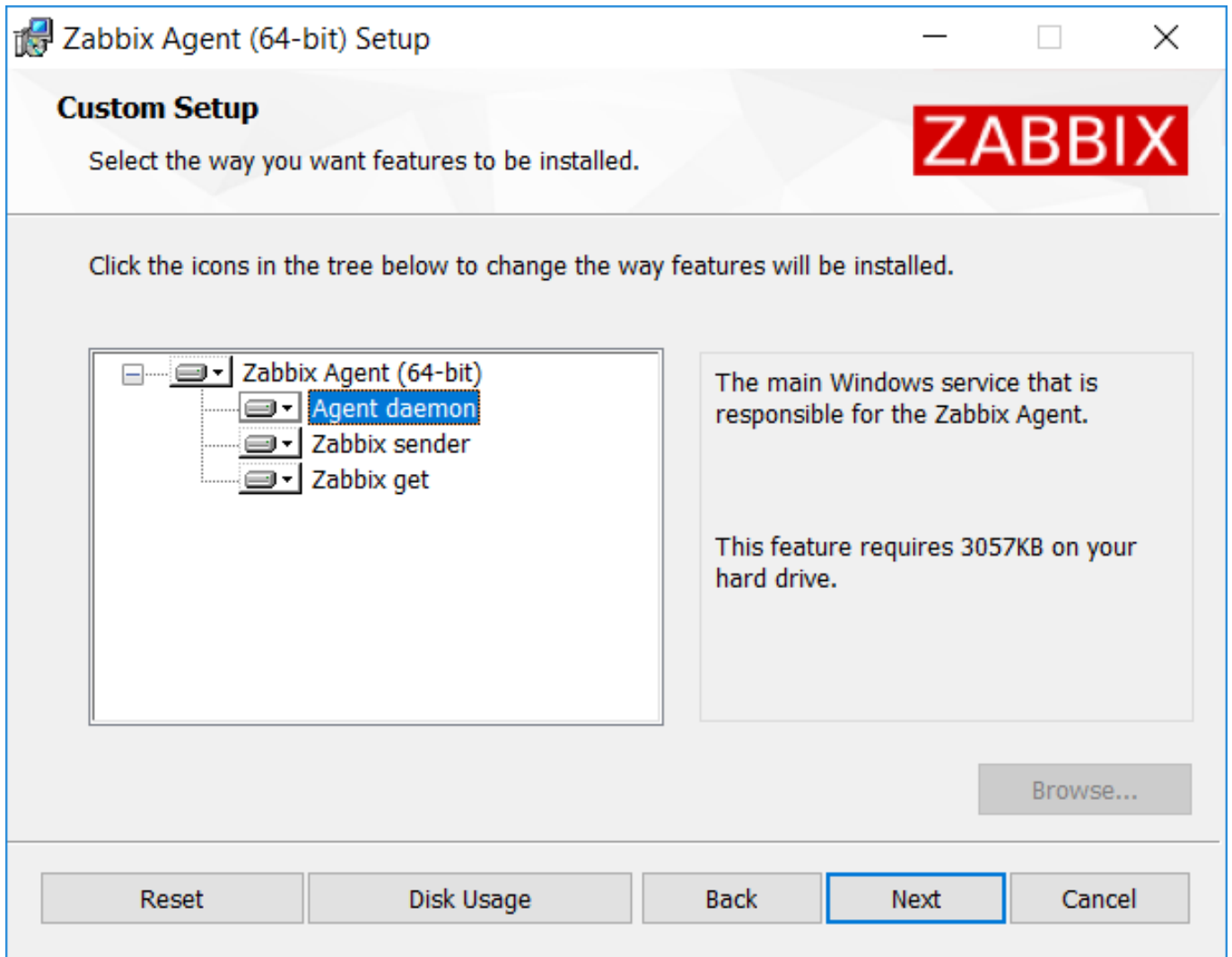

Select Zabbix components to install - Zabbix agent daemon, Zabbix sender, Zabbix get.

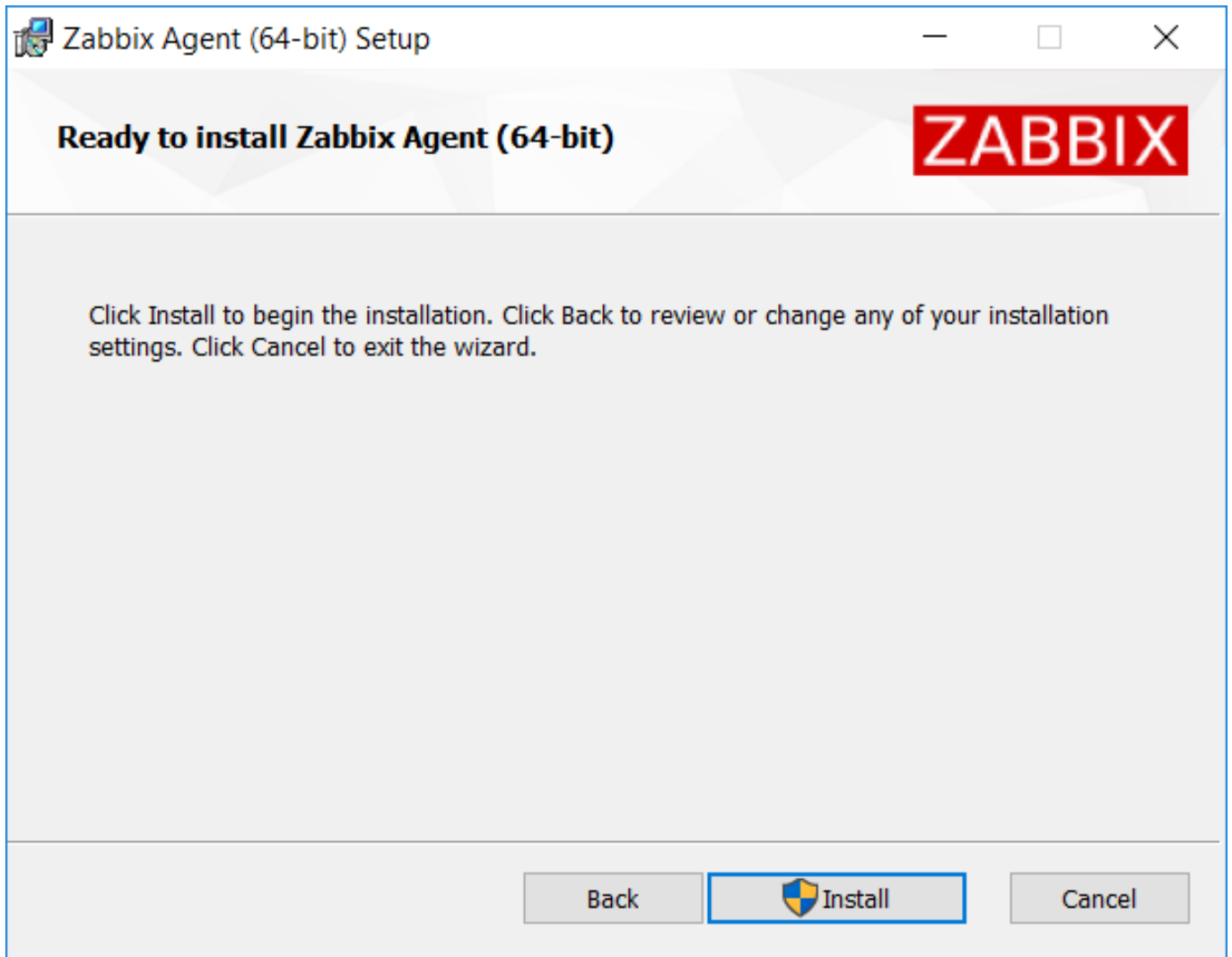

Zabbix components along with the configuration file will be installed in a *Zabbix Agent* folder in Program Files. `zabbix_agentd.exe` will be set up as Windows service with delayed automatic startup (or automatic startup on Windows versions before Windows Server 2008/Vista).

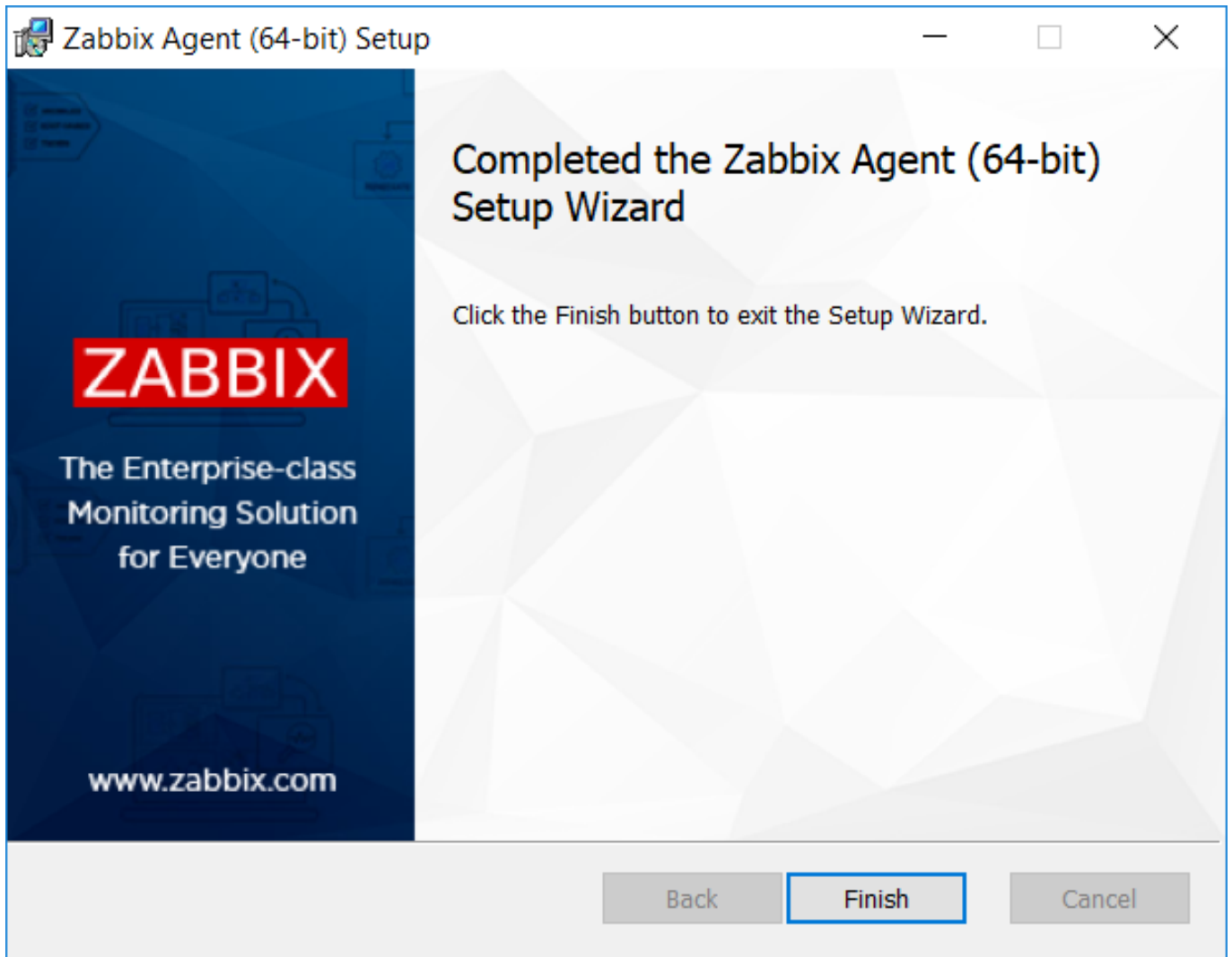

Command-line based installation

Supported parameters

The following parameters are supported by created MSIs.

Parameter	Description
ADDDEFAULT	A comma-delimited list of programs to install in their default configuration. Possible values: AgentProgram, GetProgram, SenderProgram, ALL. Example: ADDDEFAULT=AgentProgram,GetProgram
ADDLOCAL	A comma-delimited list of programs to install locally. Possible values: AgentProgram, GetProgram, SenderProgram, ALL. Example: ADDLOCAL=AgentProgram,SenderProgram
ALLOWDENYKEY	Sequence of "AllowKey" and "DenyKey" parameters separated by ; Use \; to escape the delimiter. Example: ALLOWDENYKEY="AllowKey=system.run[type c:\windows\system32\drivers\etc\hosts];DenyKey=system.run[*]"
CONF	The full pathname to a custom configuration file. Example: CONF=c:\full\path\to\user.conf
ENABLEPATH	Add agent location to the PATH variable.
ENABLEPERSISTENTBUFFER	Zabbix agent 2 only. Enable the usage of local persistent storage for active items.
HOSTINTERFACE	An optional parameter that defines the host interface.
HOSTMETADATA	An optional parameter that defines the host metadata.
HOSTMETADATAITEM	An optional parameter that defines a Zabbix agent item used for getting the host metadata.
HOSTNAME	An optional parameter that defines the hostname.
INCLUDE	Sequence of includes separated by ;
INSTALLFOLDER	The full pathname of the folder in which Zabbix components along with the configuration file will be installed.
LISTENIP	A list of comma-delimited IP addresses that the agent should listen on.

Parameter	Description
LISTENPORT	The agent will listen on this port for connections from the server.
LOGFILE	The name of the log file.
LOGTYPE	The type of the log output.
PERSISTENTBUFFERFILE	Zabbix agent 2 only. The file where Zabbix agent 2 should keep the SQLite database.
PERSISTENTBUFFERPERIOD	Zabbix agent 2 only. The time period for which data should be stored when there is no connection to the server or proxy.
SERVER	A list of comma-delimited IP addresses, optionally in CIDR notation, or DNS names of Zabbix servers and Zabbix proxies.
SERVERACTIVE	The Zabbix server/proxy address or cluster configuration to get active checks from.
SKIP	SKIP=fw - do not install the firewall exception rule.
STARTUPTYPE	Startup type of the Zabbix Windows agent/agent 2 service. Possible values: automatic - start the service automatically at Windows startup; delayed - (default) delay starting the service after the automatically started services have completed startup (available on Windows Server 2008/Vista and later versions); manual - start the service manually (by a user or application); disabled - disable the service, so that it cannot be started by a user or application. Example: STARTUPTYPE=disabled
STATUSPORT	Zabbix agent 2 only. If set, the agent will listen on this port for HTTP status requests (http://localhost:<port>/status).
TIMEOUT	Specifies timeout for communications (in seconds).
TLSACCEPT	What incoming connections to accept.
TLSCAFILE	The full pathname of a file containing the top-level CA(s) certificates for peer certificate verification, used for encrypted communications between Zabbix components.
TLSCERTFILE	The full pathname of a file containing the agent certificate or certificate chain, used for encrypted communications between Zabbix components.
TLSCONNECT	How the agent should connect to Zabbix server or proxy.
TLSCTRLFILE	The full pathname of a file containing revoked certificates. This parameter is used for encrypted communications between Zabbix components.
TLSKEYFILE	The full pathname of a file containing the agent private key, used for encrypted communications between Zabbix components.
TLSPSKFILE	The full pathname of a file containing the agent pre-shared key , used for encrypted communications with Zabbix server.
TLSPSKIDENTITY	The pre-shared key identity string, used for encrypted communications with Zabbix server.
TLSPSKVALUE	The pre-shared key string value, used for encrypted communications with Zabbix server.
TLSSERVERCERTISSUER	The allowed server (proxy) certificate issuer.
TLSSERVERCERTSUBJECT	The allowed server (proxy) certificate subject.

Examples

To install Zabbix Windows agent from the command-line, you may run, for example:

```
SET INSTALLFOLDER=C:\Program Files\Zabbix Agent

msiexec /l*v log.txt /i zabbix_agent-7.2.0-x86.msi /qn^
LOGTYPE=file^
LOGFILE="%INSTALLFOLDER%\zabbix_agentd.log"^
SERVER=192.168.6.76^
LISTENPORT=12345^
SERVERACTIVE=: :1^
HOSTNAME=myHost^
TLSCONNECT=psk^
TLSACCEPT=psk^
TLSPSKIDENTITY=MyPSKID^
TLSPSKFILE="%INSTALLFOLDER%\mykey.psk"^
TLSCAFILE="c:\temp\f.txt1"^
TLSCTRLFILE="c:\temp\f.txt2"^
TLSSERVERCERTISSUER="My CA"^
TLSSERVERCERTSUBJECT="My Cert"^
TLSCERTFILE="c:\temp\f.txt5"^
TLSKEYFILE="c:\temp\f.txt6"^
ENABLEPATH=1^
INSTALLFOLDER="%INSTALLFOLDER%"^
```

```
SKIP=fw^
ALLOWDENYKEY="DenyKey=vfs.file.contents[/etc/passwd]"
```

You may also run, for example:

```
msiexec /l*v log.txt /i zabbix_agent-7.2.0-x86.msi /qn^
SERVER=192.168.6.76^
TLSCONNECT=psk^
TLSACCEPT=psk^
TLSPSKIDENTITY=MyPSKID^
TLSPSKVALUE=1f87b595725ac58dd977beef14b97461a7c1045b9a1c963065002c5473194952
```

Note:

If both TLSPSKFILE and TLSPSKVALUE are passed, then TLSPSKVALUE will be written to TLSPSKFILE.

5 Mac OS agent installation from PKG

Overview

Zabbix Mac OS agent can be installed from PKG installer packages available for [download](#). Versions with or without encryption are available.

Installing agent

The agent can be installed using the graphical user interface or from the command line, for example:

```
sudo installer -pkg zabbix_agent-7.0.0-macos-amd64-openssl.pkg -target /
```

Make sure to use the correct Zabbix package version in the command. It must match the name of the downloaded package.

Running agent

The agent will start automatically after installation or restart.

You may edit the configuration file at `/usr/local/etc/zabbix/zabbix_agentd.conf` if necessary.

To start the agent manually, you may run:

```
sudo launchctl start com.zabbix.zabbix_agentd
```

To stop the agent manually:

```
sudo launchctl stop com.zabbix.zabbix_agentd
```

During upgrade, the existing configuration file is not overwritten. Instead a new `zabbix_agentd.conf.NEW` file is created to be used for reviewing and updating the existing configuration file, if necessary. Remember to restart the agent after manual changes to the configuration file.

Troubleshooting and removing agent

This section lists some useful commands that can be used for troubleshooting and removing Zabbix agent installation.

See if Zabbix agent is running:

```
ps aux | grep zabbix_agentd
```

See if Zabbix agent has been installed from packages:

```
pkgutil --pkgs | grep zabbix
com.zabbix.pkg.ZabbixAgent
```

See the files that were installed from the installer package (note that the initial `/` is not displayed in this view):

```
pkgutil --only-files --files com.zabbix.pkg.ZabbixAgent
Library/LaunchDaemons/com.zabbix.zabbix_agentd.plist
usr/local/bin/zabbix_get
usr/local/bin/zabbix_sender
usr/local/etc/zabbix/zabbix_agentd/userparameter_examples.conf.NEW
usr/local/etc/zabbix/zabbix_agentd/userparameter_mysql.conf.NEW
usr/local/etc/zabbix/zabbix_agentd.conf.NEW
usr/local/sbin/zabbix_agentd
```

Stop Zabbix agent if it was launched with `launchctl`:

```
sudo launchctl unload /Library/LaunchDaemons/com.zabbix.zabbix_agentd.plist
```

Remove files (including configuration and logs) that were installed with installer package:

```
sudo rm -f /Library/LaunchDaemons/com.zabbix.zabbix_agentd.plist
sudo rm -f /usr/local/sbin/zabbix_agentd
sudo rm -f /usr/local/bin/zabbix_get
sudo rm -f /usr/local/bin/zabbix_sender
sudo rm -rf /usr/local/etc/zabbix
sudo rm -rf /var/log/zabbix
```

Forget that Zabbix agent has been installed:

```
sudo pkgutil --forget com.zabbix.pkg.ZabbixAgent
```

6 Unstable releases

Overview

The instructions below are for enabling unstable Zabbix release repositories (disabled by default) used for minor Zabbix version release candidates.

First, install or update to the latest zabbix-release package. To enable rc packages on your system do the following:

Red Hat Enterprise Linux

Open the `/etc/yum.repos.d/zabbix.repo` file and set `enabled=1` for the `zabbix-unstable` repo.

```
[zabbix-unstable]
name=Zabbix Official Repository (unstable) - $basearch
baseurl=https://repo.zabbix.com/zabbix/7.2/unstable/rhel/8/$basearch/
enabled=1
gpgcheck=1
gpgkey=file:///etc/pki/rpm-gpg/RPM-GPG-KEY-ZABBIX-A14FE591
```

Debian/Ubuntu

Open the `/etc/apt/sources.list.d/zabbix.list` and uncomment "Zabbix unstable repository".

```
#### Zabbix unstable repository
deb https://repo.zabbix.com/zabbix/7.2/unstable/debian bullseye main
deb-src https://repo.zabbix.com/zabbix/7.2/unstable/debian bullseye main
```

SUSE

Open the `/etc/zypp/repos.d/zabbix.repo` file and set `enable=1` for the `zabbix-unstable` repo.

```
[zabbix-unstable]
name=Zabbix Official Repository
type=rpm-md
baseurl=https://repo.zabbix.com/zabbix/7.2/unstable/sles/15/x86_64/
gpgcheck=1
gpgkey=https://repo.zabbix.com/zabbix/7.2/unstable/sles/15/x86_64/repoata/repomd.xml.key
enabled=1
update=1
```

5 Installation from containers

Overview This section describes how to deploy Zabbix with [Docker](#) or [Docker Compose](#).

Zabbix officially provides:

- Separate Docker images for each Zabbix component to run as portable and self-sufficient containers.
- Compose files for defining and running multi-container Zabbix components in Docker.

Attention:

Since Zabbix 6.0, deterministic triggers need to be created during the installation. If binary logging is enabled for MySQL/MariaDB, this requires superuser privileges or setting the variable/configuration parameter `log_bin_trust_function_creators = 1`. See [Database creation scripts](#) for instructions how to set the variable.

Note that if executing from a console, the variable will only be set temporarily and will be dropped when a Docker is restarted. In this case, keep your SQL service running, only stop zabbix-server service by running 'docker compose down zabbix-server' and then 'docker compose up -d zabbix-server'.

Alternatively, you can set this variable in the configuration file.

Source files

Docker file sources are stored in the Zabbix [official repository](#) on GitHub, where you can follow latest file changes or fork the project to make your own images.

Docker Zabbix provides images based on a variety of OS base images. To get the list of supported base operating system images for a specific Zabbix component, see the component's description in [Docker Hub](#). All Zabbix images are configured to rebuild latest images if base images are updated.

Installation

To get Zabbix component image, run:

```
docker pull zabbix/zabbix-server-mysql
```

Replace `zabbix/zabbix-server-mysql` with the name of the required docker repository.

This command will pull the latest stable Zabbix component version based on the Alpine Linux OS. You can append **tags** to the repository name to get an image based on another operating system or of the specific Zabbix major or minor version.

The following repositories are available in Docker Hub:

Component	Docker repository
<i>Zabbix agent</i>	zabbix/zabbix-agent
<i>Zabbix server</i>	
with MySQL support	zabbix/zabbix-server-mysql
with PostgreSQL support	zabbix/zabbix-server-pgsql
<i>Zabbix web interface</i>	
based on Apache2 web server with MySQL support	zabbix/zabbix-web-apache-mysql
based on Apache2 web server with PostgreSQL support	zabbix/zabbix-web-apache-pgsql
based on Nginx web server with MySQL support	zabbix/zabbix-web-nginx-mysql
based on Nginx web server with PostgreSQL support	zabbix/zabbix-web-nginx-pgsql
<i>Zabbix proxy</i>	
with SQLite3 support	zabbix/zabbix-proxy-sqlite3
with MySQL support	zabbix/zabbix-proxy-mysql
<i>Zabbix Java gateway</i>	zabbix/zabbix-java-gateway

Note:

SNMP trap support is provided in a separate repository [zabbix/zabbix-snmptraps](#). It can be linked with Zabbix server and Zabbix proxy.

Tags

Official Zabbix component images may contain the following tags:

Tag	Description	Example
latest	The latest stable version of a Zabbix component based on Alpine Linux image.	zabbix-agent:latest
<OS>-trunk	The latest nightly build of the Zabbix version that is currently being developed on a specific operating system. <OS> - the base operating system. Supported values: <i>alpine</i> - Alpine Linux; <i>ltsc2019</i> - Windows 10 LTSC 2019 (agent only); <i>ol</i> - Oracle Linux; <i>ltsc2022</i> - Windows 11 LTSC 2022 (agent only); <i>ubuntu</i> - Ubuntu	zabbix-agent:ubuntu-trunk
<OS>-latest	The latest stable version of a Zabbix component on a specific operating system. <OS> - the base operating system. Supported values: <i>alpine</i> - Alpine Linux; <i>ltsc2019</i> - Windows 10 LTSC 2019 (agent only); <i>ol</i> - Oracle Linux; <i>ltsc2022</i> - Windows 11 LTSC 2022 (agent only); <i>ubuntu</i> - Ubuntu	zabbix-agent:ol-latest
<OS>-X.X-latest	The latest minor version of a Zabbix component of a specific major version and operating system. <OS> - the base operating system. Supported values: <i>alpine</i> - Alpine Linux; <i>ltsc2019</i> - Windows 10 LTSC 2019 (agent only); <i>ol</i> - Oracle Linux; <i>ltsc2022</i> - Windows 11 LTSC 2022 (agent only); <i>ubuntu</i> - Ubuntu	zabbix-agent:alpine-7.2-latest
<OS>-X.X.*	X.X - the major Zabbix version (i.e. 6.0, 7.0, 7.2). The latest minor version of a Zabbix component of a specific major version and operating system. <OS> - the base operating system. Supported values: <i>alpine</i> - Alpine Linux; <i>ltsc2019</i> - Windows 10 LTSC 2019 (agent only); <i>ol</i> - Oracle Linux; <i>ltsc2022</i> - Windows 11 LTSC 2022 (agent only); <i>ubuntu</i> - Ubuntu X.X - the major Zabbix version (i.e. 6.0, 7.0, 7.2). * - the Zabbix minor version	zabbix-agent:alpine-7.2.1

Initial configuration

After downloading the images, start the containers by executing `docker run` command followed by additional arguments to specify required **environment variables** and/or **mount points**. Some **configuration examples** are provided below.

Note:

To enable communication between Zabbix components, some ports, such as 10051/TCP for Zabbix server (trapper), 10050/TCP for Zabbix agent, 162/UDP for SNMP traps and 80/TCP for Zabbix web interface will be exposed to a host machine. Full list of default ports used by Zabbix components is available on the **Requirements** page. For Zabbix server and agent the default port can be changed by setting `ZBX_LISTENPORT` **environment variable**.

Environment variables

All Zabbix component images provide environment variables to control configuration. Supported environment variables are listed in the **component repository**.

These environment variables are options from Zabbix configuration files, but with different naming method. For example, ZBX_LOGSLOWQUERIES is equal to LogSlowQueries from Zabbix **server** or Zabbix **proxy** configuration files.

Attention:

Some configuration options (e.g., PIDFile and LogType) cannot be changed.

The following environment variables are specific to Docker components and do not exist in Zabbix configuration files:

Variable	Components	Default value	Description
DB_SERVER_HOST	Server Proxy Web interface	mysql-server for MySQL postgres-server for PostgreSQL	IP or DNS name of MySQL or PostgreSQL server.
DB_SERVER_PORT	Server Proxy Web interface	3306 for MySQL 5432 for PostgreSQL	Port of MySQL or PostgreSQL server.
MYSQL_USER	Server Proxy Web-interface	zabbix	MySQL database user.
MYSQL_PASSWORD	Server Proxy Web interface	zabbix	MySQL database password.
MYSQL_DATABASE	Server Proxy Web interface	zabbix for Zabbix server zabbix_proxy for Zabbix proxy	Zabbix database name.
POSTGRES_USER	Server Web interface	zabbix	PostgreSQL database user.
POSTGRES_PASSWORD	Server Web interface	zabbix	PostgreSQL database password.
POSTGRES_DB	Server Web interface	zabbix for Zabbix server zabbix_proxy for Zabbix proxy	Zabbix database name.
PHP_TZ	Web-interface	Europe/Riga	Timezone in PHP format. Full list of supported timezones is available on php.net .
ZBX_SERVER_NAME	Web interface	Zabbix Docker	Visible Zabbix installation name in right top corner of the web interface.
ZBX_JAVAGATEWAY_ENABLE	Server Proxy	false	Enables communication with Zabbix Java gateway to collect Java related checks.
ZBX_ENABLE_SNMP_TRAPS	Server Proxy	false	Enables SNMP trap feature. It requires zabbix-snmptests instance and shared volume <code>/var/lib/zabbix/snmptests</code> to Zabbix server or Zabbix proxy.

Volumes

The images allow to mount volumes using the following mount points:

Volume	Description
Zabbix agent	
<code>/etc/zabbix/zabbix_agentd.conf</code>	The volume allows to include <code>*.conf</code> files and extend Zabbix agent using the <code>UserParameter</code> feature
<code>/var/lib/zabbix/modules</code>	The volume allows to load additional modules and extend Zabbix agent using the <code>LoadModule</code> feature
<code>/var/lib/zabbix/enc</code>	The volume is used to store TLS-related files. These file names are specified using <code>ZBX_TLSCAFILE</code> , <code>ZBX_TLSCRLFILE</code> , <code>ZBX_TLSKEY_FILE</code> and <code>ZBX_TLSPSKFILE</code> environment variables
Zabbix server	

Volume	Description
<code>/usr/lib/zabbix/alertscripts</code>	The volume is used for custom alert scripts. It is the <code>AlertScriptsPath</code> parameter in <code>zabbix_server.conf</code>
<code>/usr/lib/zabbix/externalScripts</code>	The volume is used by <code>external checks</code> . It is the <code>ExternalScripts</code> parameter in <code>zabbix_server.conf</code>
<code>/var/lib/zabbix/modules</code>	The volume allows to load additional modules and extend Zabbix server using the <code>LoadModule</code> feature
<code>/var/lib/zabbix/enc</code>	The volume is used to store TLS related files. These file names are specified using <code>ZBX_TLSCAFILE</code> , <code>ZBX_TLSCRLFILE</code> , <code>ZBX_TLSKEY_FILE</code> and <code>ZBX_TLSPSKFILE</code> environment variables
<code>/var/lib/zabbix/ssl/certs</code>	The volume is used as location of SSL client certificate files for client authentication. It is the <code>SSLCertLocation</code> parameter in <code>zabbix_server.conf</code>
<code>/var/lib/zabbix/ssl/keys</code>	The volume is used as location of SSL private key files for client authentication. It is the <code>SSLKeyLocation</code> parameter in <code>zabbix_server.conf</code>
<code>/var/lib/zabbix/ssl/ssl_ca</code>	The volume is used as location of certificate authority (CA) files for SSL server certificate verification. It is the <code>SSLCALocation</code> parameter in <code>zabbix_server.conf</code>
<code>/var/lib/zabbix/snmptraps</code>	The volume is used as location of <code>snmptraps.log</code> file. It could be shared by <code>zabbix-snmptraps</code> container and inherited using the <code>volumes_from</code> Docker option while creating a new instance of Zabbix server. SNMP trap processing feature could be enabled by using shared volume and switching the <code>ZBX_ENABLE_SNMP_TRAPS</code> environment variable to 'true'
<code>/var/lib/zabbix/mibs</code>	The volume allows to add new MIB files. It does not support subdirectories, all MIBs must be placed in <code>/var/lib/zabbix/mibs</code>

Zabbix proxy

<code>/usr/lib/zabbix/externalScripts</code>	The volume is used by <code>external checks</code> . It is the <code>ExternalScripts</code> parameter in <code>zabbix_proxy.conf</code>
<code>/var/lib/zabbix/db_data</code>	The volume allows to store database files on external devices. Supported only for Zabbix proxy with SQLite3
<code>/var/lib/zabbix/modules</code>	The volume allows to load additional modules and extend Zabbix server using the <code>LoadModule</code> feature
<code>/var/lib/zabbix/enc</code>	The volume is used to store TLS related files. These file names are specified using <code>ZBX_TLSCAFILE</code> , <code>ZBX_TLSCRLFILE</code> , <code>ZBX_TLSKEY_FILE</code> and <code>ZBX_TLSPSKFILE</code> environment variables
<code>/var/lib/zabbix/ssl/certs</code>	The volume is used as location of SSL client certificate files for client authentication. It is the <code>SSLCertLocation</code> parameter in <code>zabbix_proxy.conf</code>
<code>/var/lib/zabbix/ssl/keys</code>	The volume is used as location of SSL private key files for client authentication. It is the <code>SSLKeyLocation</code> parameter in <code>zabbix_proxy.conf</code>
<code>/var/lib/zabbix/ssl/ssl_ca</code>	The volume is used as location of certificate authority (CA) files for SSL server certificate verification. It is the <code>SSLCALocation</code> parameter in <code>zabbix_proxy.conf</code>
<code>/var/lib/zabbix/snmptraps</code>	The volume is used as location of <code>snmptraps.log</code> file. It could be shared by the <code>zabbix-snmptraps</code> container and inherited using the <code>volumes_from</code> Docker option while creating a new instance of Zabbix server. SNMP trap processing feature could be enabled by using shared volume and switching the <code>ZBX_ENABLE_SNMP_TRAPS</code> environment variable to 'true'
<code>/var/lib/zabbix/mibs</code>	The volume allows to add new MIB files. It does not support subdirectories, all MIBs must be placed in <code>/var/lib/zabbix/mibs</code>

Zabbix web interface based on Apache2 web server

<code>/etc/ssl/apache2</code>	The volume allows to enable HTTPS for Zabbix web interface. The volume must contain the two <code>ssl.crt</code> and <code>ssl.key</code> files prepared for Apache2 SSL connections
-------------------------------	--

Volume	Description
Zabbix web interface based on Nginx web server <i>/etc/ssl/nginx</i>	The volume allows to enable HTTPS for Zabbix web interface. The volume must contain the two <code>ssl.crt</code> , <code>ssl.key</code> files and <code>dhparam.pem</code> prepared for Nginx SSL connections
Zabbix snmptraps <i>/var/lib/zabbix/snmptraps</i>	The volume contains the <code>snmptraps.log</code> log file named with received SNMP traps
<i>/var/lib/zabbix/mibs</i>	The volume allows to add new MIB files. It does not support subdirectories, all MIBs must be placed in <code>/var/lib/zabbix/mibs</code>

For additional information, see Zabbix official repositories in Docker Hub.

Examples

Example 1

The example demonstrates how to run Zabbix server with MySQL database support, Zabbix web interface based on the Nginx web server and Zabbix Java gateway.

1. Create network dedicated for Zabbix component containers:

```
docker network create --subnet 172.20.0.0/16 --ip-range 172.20.240.0/20 zabbix-net
```

2. Start empty MySQL server instance

```
docker run --name mysql-server -t \
  -e MYSQL_DATABASE="zabbix" \
  -e MYSQL_USER="zabbix" \
  -e MYSQL_PASSWORD="zabbix_pwd" \
  -e MYSQL_ROOT_PASSWORD="root_pwd" \
  --network=zabbix-net \
  --restart unless-stopped \
  -d mysql:8.0-oracle \
  --character-set-server=utf8 --collation-server=utf8_bin \
  --default-authentication-plugin=mysql_native_password
```

3. Start Zabbix Java gateway instance

```
docker run --name zabbix-java-gateway -t \
  --network=zabbix-net \
  --restart unless-stopped \
  -d zabbix/zabbix-java-gateway:alpine-7.2-latest
```

4. Start Zabbix server instance and link the instance with created MySQL server instance

```
docker run --name zabbix-server-mysql -t \
  -e DB_SERVER_HOST="mysql-server" \
  -e MYSQL_DATABASE="zabbix" \
  -e MYSQL_USER="zabbix" \
  -e MYSQL_PASSWORD="zabbix_pwd" \
  -e MYSQL_ROOT_PASSWORD="root_pwd" \
  -e ZBX_JAVAGATEWAY="zabbix-java-gateway" \
  --network=zabbix-net \
  -p 10051:10051 \
  --restart unless-stopped \
  -d zabbix/zabbix-server-mysql:alpine-7.2-latest
```

5. Start Zabbix web interface and link the instance with created MySQL server and Zabbix server instances

```
docker run --name zabbix-web-nginx-mysql -t \  
-e ZBX_SERVER_HOST="zabbix-server-mysql" \  
-e DB_SERVER_HOST="mysql-server" \  
-e MYSQL_DATABASE="zabbix" \  
-e MYSQL_USER="zabbix" \  
-e MYSQL_PASSWORD="zabbix_pwd" \  
-e MYSQL_ROOT_PASSWORD="root_pwd" \  
--network=zabbix-net \  
-p 80:8080 \  
--restart unless-stopped \  
-d zabbix/zabbix-web-nginx-mysql:alpine-7.2-latest
```

Example 2

The example demonstrates how to run Zabbix server with PostgreSQL database support, Zabbix web interface based on the Nginx web server and SNMP trap feature.

1. Create network dedicated for Zabbix component containers:

```
docker network create --subnet 172.20.0.0/16 --ip-range 172.20.240.0/20 zabbix-net
```

2. Start empty PostgreSQL server instance

```
docker run --name postgres-server -t \  
-e POSTGRES_USER="zabbix" \  
-e POSTGRES_PASSWORD="zabbix_pwd" \  
-e POSTGRES_DB="zabbix" \  
--network=zabbix-net \  
--restart unless-stopped \  
-d postgres:latest
```

3. Start Zabbix snmptraps instance

```
docker run --name zabbix-snmptests -t \  
-v /zbx_instance/snmptests:/var/lib/zabbix/snmptests:rw \  
-v /var/lib/zabbix/mibs:/usr/share/snmp/mibs:ro \  
--network=zabbix-net \  
-p 162:1162/udp \  
--restart unless-stopped \  
-d zabbix/zabbix-snmptests:alpine-7.2-latest
```

4. Start Zabbix server instance and link the instance with created PostgreSQL server instance

```
docker run --name zabbix-server-pgsql -t \  
-e DB_SERVER_HOST="postgres-server" \  
-e POSTGRES_USER="zabbix" \  
-e POSTGRES_PASSWORD="zabbix_pwd" \  
-e POSTGRES_DB="zabbix" \  
-e ZBX_ENABLE_SNMP_TRAPS="true" \  
--network=zabbix-net \  
-p 10051:10051 \  
--volumes-from zabbix-snmptests \  
--restart unless-stopped \  
-d zabbix/zabbix-server-pgsql:alpine-7.2-latest
```

5. Start Zabbix web interface and link the instance with created PostgreSQL server and Zabbix server instances

```
docker run --name zabbix-web-nginx-pgsql -t \  
-e ZBX_SERVER_HOST="zabbix-server-pgsql" \  
-e DB_SERVER_HOST="postgres-server" \  
-e POSTGRES_USER="zabbix" \  
-e POSTGRES_PASSWORD="zabbix_pwd" \  
-e POSTGRES_DB="zabbix" \  
--network=zabbix-net \  
-p 443:8443 \  
-p 80:8080 \  
-v /etc/ssl/nginx:/etc/ssl/nginx:ro \  
--restart unless-stopped
```

```
--restart unless-stopped \  
-d zabbix/zabbix-web-nginx-pgsql:alpine-7.2-latest
```

Example 3

The example demonstrates how to run Zabbix server with MySQL database support, Zabbix web interface based on the Nginx web server and Zabbix Java gateway using podman on Red Hat 8.

1. Create new pod with name zabbix and exposed ports (web-interface, Zabbix server trapper):

```
podman pod create --name zabbix -p 80:8080 -p 10051:10051
```

2. (optional) Start Zabbix agent container in zabbix pod location:

```
podman run --name zabbix-agent \  
-e ZBX_SERVER_HOST="127.0.0.1,localhost" \  
--restart=always \  
--pod=zabbix \  
-d registry.connect.redhat.com/zabbix/zabbix-agent-70:latest
```

3. Create `./mysql/` directory on host and start Oracle MySQL server 8.0:

```
podman run --name mysql-server -t \  
-e MYSQL_DATABASE="zabbix" \  
-e MYSQL_USER="zabbix" \  
-e MYSQL_PASSWORD="zabbix_pwd" \  
-e MYSQL_ROOT_PASSWORD="root_pwd" \  
-v ./mysql/:/var/lib/mysql/:Z \  
--restart=always \  
--pod=zabbix \  
-d mysql:8.0 \  
--character-set-server=utf8 --collation-server=utf8_bin \  
--default-authentication-plugin=mysql_native_password
```

4. Start Zabbix server container:

```
podman run --name zabbix-server-mysql -t \  
-e DB_SERVER_HOST="127.0.0.1" \  
-e MYSQL_DATABASE="zabbix" \  
-e MYSQL_USER="zabbix" \  
-e MYSQL_PASSWORD="zabbix_pwd" \  
-e MYSQL_ROOT_PASSWORD="root_pwd" \  
-e ZBX_JAVAGATEWAY="127.0.0.1" \  
--restart=always \  
--pod=zabbix \  
-d registry.connect.redhat.com/zabbix/zabbix-server-mysql-70
```

5. Start Zabbix Java Gateway container:

```
podman run --name zabbix-java-gateway -t \  
--restart=always \  
--pod=zabbix \  
-d registry.connect.redhat.com/zabbix/zabbix-java-gateway-70
```

6. Start Zabbix web-interface container:

```
podman run --name zabbix-web-mysql -t \  
-e ZBX_SERVER_HOST="127.0.0.1" \  
-e DB_SERVER_HOST="127.0.0.1" \  
-e MYSQL_DATABASE="zabbix" \  
-e MYSQL_USER="zabbix" \  
-e MYSQL_PASSWORD="zabbix_pwd" \  
-e MYSQL_ROOT_PASSWORD="root_pwd" \  
--restart=always \  
--pod=zabbix \  
-d registry.connect.redhat.com/zabbix/zabbix-web-mysql-70
```

Note:

Pod zabbix exposes 80/TCP port (HTTP) to host machine from 8080/TCP of zabbix-web-mysql container.

Docker Compose Alternatively, Zabbix can be installed using Docker Compose plugin. Compose files for defining and running multi-container Zabbix components are available in the official [Zabbix Docker repository](#) on GitHub.

Attention:
Official Zabbix compose files support version 3 of Docker Compose.

These compose files are added as examples; they are overloaded. For example, they contain proxies with both MySQL and SQLite3 support.

To obtain Docker compose files provided by Zabbix, clone the repository:

```
git clone https://github.com/zabbix/zabbix-docker.git
```

Switch to the required version:

```
git checkout 7.2
```

Compose configuration files and create and start containers:

```
docker compose -f ./docker-compose_v3_alpine_mysql_latest.yaml up
```

Replace `docker-compose_v3_alpine_mysql_latest.yaml` in the command above with the required configuration file.

The following options are available:

File name	Description
<code>docker-compose_v3_alpine_mysql_latest.yaml</code>	The <code>docker-compose_v3_alpine_mysql_latest.yaml</code> file builds the latest version of Zabbix 7.2 components on Alpine Linux with MySQL database support.
<code>docker-compose_v3_alpine_mysql_local.yaml</code>	The <code>docker-compose_v3_alpine_mysql_local.yaml</code> file builds the latest version of Zabbix 7.2 and runs Zabbix components on Alpine Linux with MySQL database support.
<code>docker-compose_v3_alpine_postgresql_latest.yaml</code>	The <code>docker-compose_v3_alpine_postgresql_latest.yaml</code> file builds the latest version of Zabbix 7.2 components on Alpine Linux with PostgreSQL database support.
<code>docker-compose_v3_alpine_postgresql_local.yaml</code>	The <code>docker-compose_v3_alpine_postgresql_local.yaml</code> file builds the latest version of Zabbix 7.2 and runs Zabbix components on Alpine Linux with PostgreSQL database support.
<code>docker-compose_v3_oracle_mysql.yaml</code>	The <code>docker-compose_v3_oracle_mysql.yaml</code> file builds the latest version of Zabbix 7.2 components on Oracle Linux with MySQL database support.
<code>docker-compose_v3_oracle_mysql_local.yaml</code>	The <code>docker-compose_v3_oracle_mysql_local.yaml</code> file builds the latest version of Zabbix 7.2 and runs Zabbix components on Oracle Linux with MySQL database support.
<code>docker-compose_v3_oracle_postgresql.yaml</code>	The <code>docker-compose_v3_oracle_postgresql.yaml</code> file builds the latest version of Zabbix 7.2 components on Oracle Linux with PostgreSQL database support.
<code>docker-compose_v3_oracle_postgresql_local.yaml</code>	The <code>docker-compose_v3_oracle_postgresql_local.yaml</code> file builds the latest version of Zabbix 7.2 and runs Zabbix components on Oracle Linux with PostgreSQL database support.
<code>docker-compose_v3_ubuntu_mysql.yaml</code>	The <code>docker-compose_v3_ubuntu_mysql.yaml</code> file builds the latest version of Zabbix 7.2 components on Ubuntu 22.04 with MySQL database support.
<code>docker-compose_v3_ubuntu_mysql_local.yaml</code>	The <code>docker-compose_v3_ubuntu_mysql_local.yaml</code> file builds the latest version of Zabbix 7.2 and runs Zabbix components on Ubuntu 22.04 with MySQL database support.
<code>docker-compose_v3_ubuntu_postgresql.yaml</code>	The <code>docker-compose_v3_ubuntu_postgresql.yaml</code> file builds the latest version of Zabbix 7.2 components on Ubuntu 22.04 with PostgreSQL database support.
<code>docker-compose_v3_ubuntu_postgresql_local.yaml</code>	The <code>docker-compose_v3_ubuntu_postgresql_local.yaml</code> file builds the latest version of Zabbix 7.2 and runs Zabbix components on Ubuntu 22.04 with PostgreSQL database support.

Storage

Compose files are configured to support local storage on a host machine. Docker Compose will create a `zbx_env` directory in the folder with the compose file when you run Zabbix components using the compose file. The directory will contain the same structure as described in the [Volumes](#) section and directory for database storage.

There are also volumes in read-only mode for `/etc/localtime` and `/etc/timezone` files.

Environment variables

The variable files have the following naming structure: `.env_<type of component>` and are located in the `env_vars` directory. See [environment variables](#) for details about variable naming and available selection.

Examples

Example 1

```
git checkout 7.2
docker compose -f ./docker-compose_v3_alpine_mysql_latest.yaml up -d
```

The command will download the latest Zabbix 7.2 images for each Zabbix component and run them in detach mode.

Attention:

Do not forget to download `.env_<type> of <component>` files from github.com official Zabbix repository with compose files.

Example 2

```
git checkout 7.2
docker compose -f ./docker-compose_v3_ubuntu_mysql_local.yaml up -d
```

The command will download base image Ubuntu 22.04 (jammy), then build Zabbix 7.2 components locally and run them in detach mode.

6 Web interface installation

This section provides step-by-step instructions for installing Zabbix web interface. Zabbix frontend is written in PHP, so to run it a PHP supported webserver is needed.

Note:

You can find out more about setting up SSL for Zabbix frontend by referring to these [best practices](#).

Welcome screen

Open Zabbix frontend URL in the browser. If you have installed Zabbix from packages, the URL is:

- for Apache: `http://<server_ip_or_name>/zabbix`
- for Nginx: `http://<server_ip_or_name>`

You should see the first screen of the frontend installation wizard.

Use the *Default language* drop-down menu to change system default language and continue the installation process in the selected language (optional). For more information, see [Installation of additional frontend languages](#).

Note that setting the language to *English (en_US)* will also enable the US time/date format in the frontend.



Check of pre-requisites

Make sure that all Zabbix frontend mandatory pre-requisites are met.



Check of pre-requisites

- Welcome
- Check of pre-requisites
- Configure DB connection
- Settings
- Pre-installation summary
- Install

	Current value	Required	
PHP version	8.1.2-1ubuntu2.14	8.0.0	OK
PHP option "memory_limit"	128M	128M	OK
PHP option "post_max_size"	16M	16M	OK
PHP option "upload_max_filesize"	2M	2M	OK
PHP option "max_execution_time"	300	300	OK
PHP option "max_input_time"	300	300	OK
PHP databases support	MySQL		OK
PHP bcmath	on		OK
PHP mbstring	on		OK
PHP option "mbstring.func_overload"	off	off	OK

Cancel

Back

Next step

Pre-requisite	Minimum value	Description
<i>PHP version</i>	8.0.0	
<i>PHP option "memory_limit"</i>	128MB	In php.ini: memory_limit = 128M
<i>PHP option "post_max_size"</i>	16MB	In php.ini: post_max_size = 16M
<i>PHP option "upload_max_filesize"</i>	2MB	In php.ini: upload_max_filesize = 2M
<i>PHP option "max_execution_time"</i>	300 seconds	In php.ini: max_execution_time = 300 (values 0 and -1 are also allowed)
<i>PHP option "max_input_time"</i>	300 seconds	In php.ini: max_input_time = 300 (values 0 and -1 are also allowed)
<i>PHP databases support</i>	One of: MySQL, PostgreSQL	See Requirements for the list of all mandatory and optional PHP extensions. Note that failed optional pre-requisites are displayed with a red <i>Warning</i> status, and the setup process can proceed even if they are not met.
<i>PHP bcmath</i>	must be enabled	
<i>PHP mbstring</i>	must be enabled	
<i>PHP option "mbstring.func_overload"</i>	must be disabled	In php.ini: mbstring.func_overload = 0
<i>PHP option "session.auto_start"</i>	must be disabled	In php.ini: session.auto_start = 0
<i>PHP option "arg_separator.output"</i>	&	In php.ini: arg_separator.output = "&" (value "&" is also allowed)

Attention:

If the Apache user or user group needs to be changed, verify the permissions to the session folder; otherwise, Zabbix setup may be unable to continue.

Configure DB connection

Enter details for connecting to the database. Zabbix database must already be created.

ZABBIX

Configure DB connection

Please create database manually, and set the configuration parameters for connection to this database. Press "Next step" button when done.

Database type:

Database host:

Database port: 0 - use default port

Database name:

Store credentials in: Plain text HashiCorp Vault CyberArk Vault

User:

Password:

Database TLS encryption: Connection will not be encrypted because it uses a socket file (on Unix) or shared memory (Windows).

If the *Database TLS encryption* option is checked, then additional fields for **configuring the TLS connection** to the database appear in the form (MySQL or PostgreSQL only).

If *Store credentials in* is set to HashiCorp Vault or CyberArk Vault, additional parameters will become available:

- for **HashiCorp Vault**: Vault API endpoint, vault prefix, secret path, and authentication token;
- for **CyberArk Vault**: Vault API endpoint, vault prefix, secret query string, and certificates. Upon marking *Vault certificates* checkbox, two new fields for specifying paths to SSL certificate file and SSL key file will appear.

ZABBIX

Configure DB connection

Database port: 0 - use default port

Database name:

Store credentials in: Plain text HashiCorp Vault CyberArk Vault

* Vault API endpoint:

Vault prefix:

* Vault secret query string:

Vault certificates:

SSL certificate file:

SSL key file:

Database TLS encryption: Connection will not be encrypted because it uses a socket file (on Unix) or shared memory (Windows).

Settings

Entering a name for Zabbix server is optional, however, if submitted, it will be displayed in the menu bar and page titles.

Set the default **time zone** and theme for the frontend.

Pre-installation summary

Review a summary of settings.

Install

If installing Zabbix from sources, download the configuration file and place it under conf/ in the webserver HTML documents subdirectory where you copied Zabbix PHP files to.

ZABBIX

Install

- Welcome
- Check of pre-requisites
- Configure DB connection
- Settings
- Pre-installation summary
- Install



Details ▲ Cannot create the configuration file.

Unable to create the configuration file.

Alternatively, you can install it manually:

1. Download the configuration file
2. Save it as "/var/www/html/zabbix/conf/zabbix.conf.php"

Back

Finish

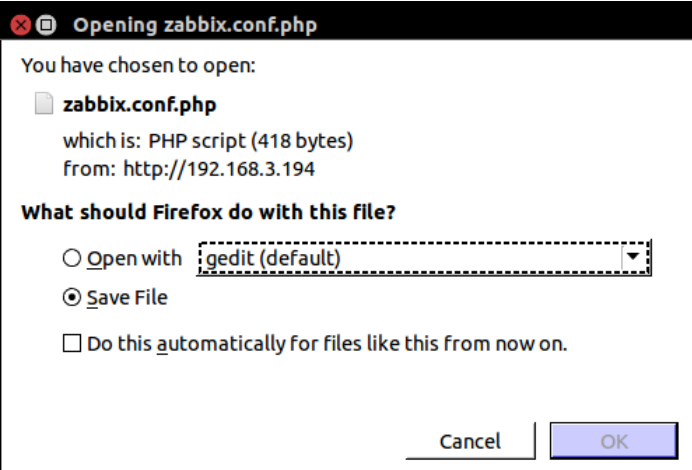

Note:

Providing the webserver user has write access to conf/ directory the configuration file would be saved automatically and it would be possible to proceed to the next step right away.

Finish the installation.

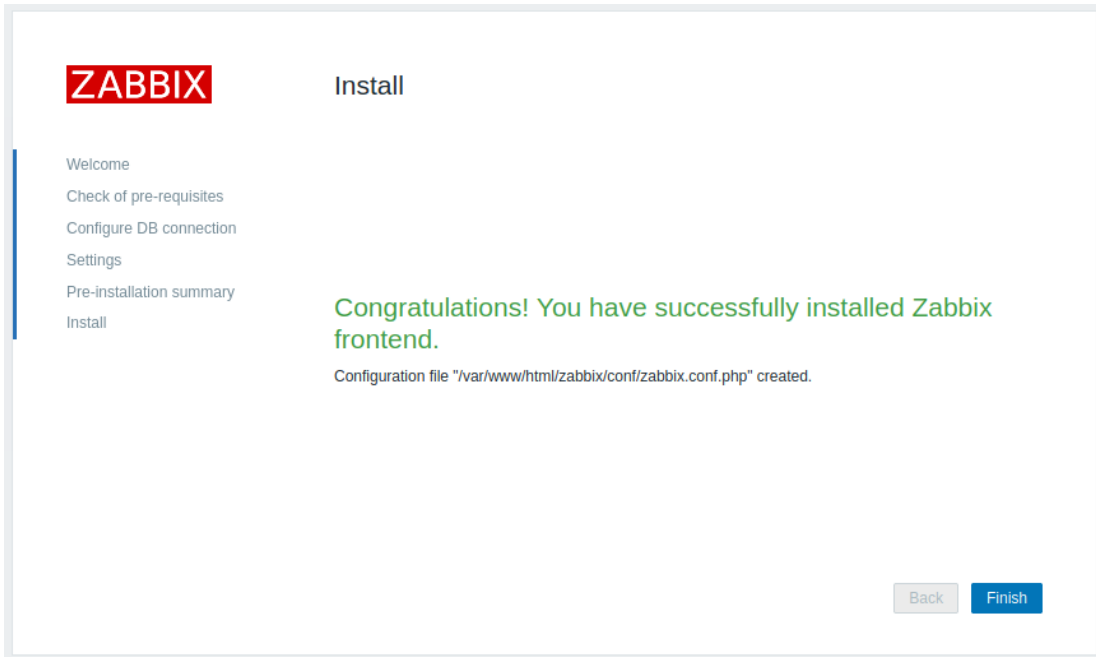

Log in

Zabbix frontend is ready! The default user name is **Admin**, password **zabbix**.

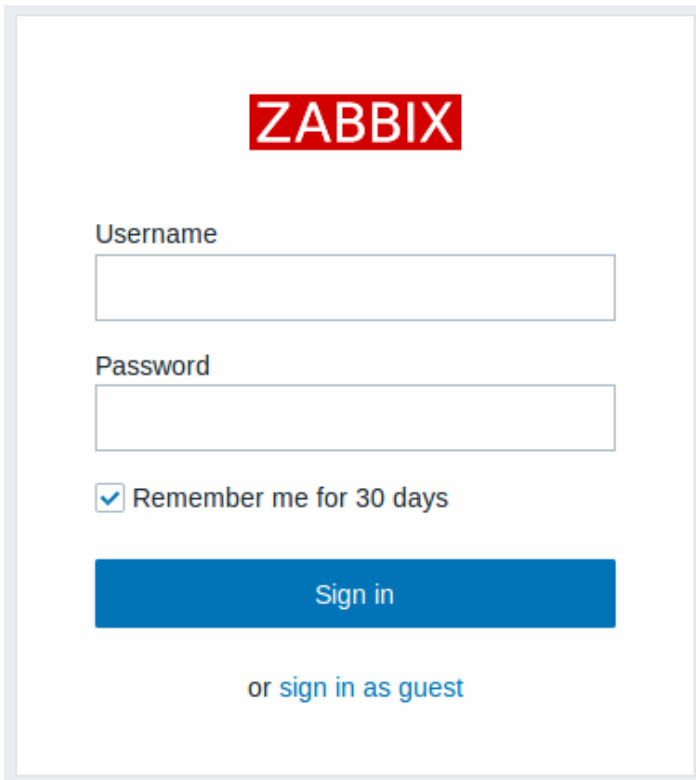

Proceed to [getting started with Zabbix](#).

7 Upgrade procedure

Overview

This section provides upgrade information for Zabbix **7.4**:

- Using packages for [Red Hat Enterprise Linux](#) or [Debian/Ubuntu](#)
- Using [sources](#)

Related instructions:

- For servers in a high-availability (HA) cluster, see [Upgrading HA cluster](#)
- For TimescaleDB database, see [Upgrading TimescaleDB schema](#)

Upgrading Zabbix agents is recommended but not mandatory.

Upgrading Zabbix proxies is highly recommended. Zabbix server fully supports proxies that are of the same major version as the server. Zabbix server also supports proxies that are **no older** than Zabbix server previous LTS release version, but with limited functionality (data collection, execution of **remote commands**, **immediate item value checks**). Configuration update is also disabled, and **outdated** proxies will only work with old configuration.

Attention:

Proxies that are older than Zabbix server previous LTS release version or newer than Zabbix server major version are not supported. Zabbix server will ignore data from unsupported proxies and all communication with Zabbix server will fail with a warning. For more information, see [Version compatibility](#).

To minimize downtime and data loss during the upgrade, it is recommended to stop, upgrade, and start Zabbix server and then stop, upgrade, and start Zabbix proxies one after another. During server downtime, running proxies will continue data collection. Once the server is up and running, **outdated** proxies will send the data to the newer server (proxy configuration will not be updated though) and will remain partly functional. Any notifications for problems during Zabbix server downtime will be generated only after the upgraded server is started.

If Zabbix proxy is started for the first time and the SQLite database file is missing, proxy creates it automatically.

Note that if Zabbix proxy uses SQLite3 and on startup detects that existing database file version is older than required, it will **delete the database file automatically** and create a new one. Therefore, history data stored in the SQLite database file will be lost. If Zabbix proxy's version is older than the database file version, Zabbix will log an error and exit.

Depending on the database size, the database upgrade to version 7.2 may take a long time.

Direct upgrade to Zabbix 7.4.x is possible from Zabbix **7.2.x**, **7.0.x**, **6.4.x**, **6.2.x**, **6.0.x**, **5.4.x**, **5.2.x**, **5.0.x**, **4.4.x**, **4.2.x**, **4.0.x**, **3.4.x**, **3.2.x**, **3.0.x**, **2.4.x**, **2.2.x** and **2.0.x**. For upgrading from earlier versions consult Zabbix documentation for 2.0 and earlier.

Note:

Please be aware that after upgrading some third-party software integrations in Zabbix might be affected, if the external software is not compatible with the upgraded Zabbix version.

The following upgrade notes are available:

Upgrade from	Read full upgrade notes	Most important changes between versions
7.2.x	For: Zabbix 7.4	
7.0.x	For: Zabbix 7.2 Zabbix 7.4	Support of Oracle DB dropped.
6.4.x	For: Zabbix 7.0 Zabbix 7.2 Zabbix 7.4	Minimum required PHP version upped from 7.4.0 to 8.0.0. Asynchronous pollers for agent, HTTP agent and SNMP walk[oid] checks. Separate database table for proxies. Default location for Windows agent configuration file changed. Oracle DB deprecated. Old numeric (float) value type dropped.
6.2.x	For: Zabbix 6.4 Zabbix 7.0 Zabbix 7.2 Zabbix 7.4	Minimum required MySQL version raised from 8.0.0 to 8.0.30. 'libevent_pthreads' library is required for Zabbix server/proxy. Upon the first launch after an upgrade, Zabbix proxy with SQLite3 automatically drops the old version of the database (with all the history) and creates a new one.
6.0.x LTS	For: Zabbix 6.2 Zabbix 6.4 Zabbix 7.0 Zabbix 7.2 Zabbix 7.4	Minimum required PHP version upped from 7.2.5 to 7.4.0. Service monitoring reworked significantly. Deterministic triggers need to be created during the upgrade. If binary logging is enabled for MySQL/MariaDB, this requires superuser privileges or setting the variable/configuration parameter <code>log_bin_trust_function_creators = 1</code> . See Database creation scripts for instructions how to set the variable.

Upgrade from	Read full upgrade notes	Most important changes between versions
5.4.x	For: Zabbix 6.0 Zabbix 6.2 Zabbix 6.4 Zabbix 7.0 Zabbix 7.2 Zabbix 7.4	Minimum required database versions upped. Server/proxy will not start if outdated database. Audit log records lost because of database structure change.
5.2.x	For: Zabbix 5.4 Zabbix 6.0 Zabbix 6.2 Zabbix 6.4 Zabbix 7.0 Zabbix 7.2 Zabbix 7.4	Minimum required database versions upped. Aggregate items removed as a separate type.
5.0.x LTS	For: Zabbix 5.2 Zabbix 5.4 Zabbix 6.0 Zabbix 6.2 Zabbix 6.4 Zabbix 7.0 Zabbix 7.2 Zabbix 7.4	Minimum required PHP version upped from 7.2.0 to 7.2.5. Password hashing algorithm changed from MD5 to bcrypt.
4.4.x	For: Zabbix 5.0 Zabbix 5.2 Zabbix 5.4 Zabbix 6.0 Zabbix 6.2 Zabbix 6.4 Zabbix 7.0 Zabbix 7.2 Zabbix 7.4	Support of IBM DB2 dropped. Minimum required PHP version upped from 5.4.0 to 7.2.0. Minimum required database versions upped. Changed Zabbix PHP file directory.
4.2.x	For: Zabbix 4.4 Zabbix 5.0 Zabbix 5.2 Zabbix 5.4 Zabbix 6.0 Zabbix 6.2 Zabbix 6.4 Zabbix 7.0 Zabbix 7.2 Zabbix 7.4	Jabber, Ez Texting media types removed.
4.0.x LTS	For: Zabbix 4.2 Zabbix 4.4 Zabbix 5.0 Zabbix 5.2 Zabbix 5.4 Zabbix 6.0 Zabbix 6.2 Zabbix 6.4 Zabbix 7.0 Zabbix 7.2 Zabbix 7.4	Older proxies no longer can report data to an upgraded server. Newer agents no longer will be able to work with an older Zabbix server.

Upgrade from	Read full upgrade notes	Most important changes between versions
3.4.x	For: Zabbix 4.0 Zabbix 4.2 Zabbix 4.4 Zabbix 5.0 Zabbix 5.2 Zabbix 5.4 Zabbix 6.0 Zabbix 6.2 Zabbix 6.4 Zabbix 7.0 Zabbix 7.2	'libpthread' and 'zlib' libraries now mandatory. Support for plain text protocol dropped and header is mandatory. Pre-1.4 version Zabbix agents are no longer supported. The Server parameter in passive proxy configuration now mandatory.
3.2.x	For: Zabbix 3.4 Zabbix 4.0 Zabbix 4.2 Zabbix 4.4 Zabbix 5.0 Zabbix 5.2 Zabbix 5.4 Zabbix 6.0 Zabbix 6.2 Zabbix 6.4 Zabbix 7.0 Zabbix 7.2 Zabbix 7.4	SQLite support as backend database dropped for Zabbix server/frontend. Perl Compatible Regular Expressions (PCRE) supported instead of POSIX extended. 'libpcre' and 'libevent' libraries mandatory for Zabbix server. Exit code checks added for user parameters, remote commands and system.run[] items without the 'nowait' flag as well as Zabbix server executed scripts. Zabbix Java gateway has to be upgraded to support new functionality.
3.0.x LTS	For: Zabbix 3.2 Zabbix 3.4 Zabbix 4.0 Zabbix 4.2 Zabbix 4.4 Zabbix 5.0 Zabbix 5.2 Zabbix 5.4 Zabbix 6.0 Zabbix 6.2 Zabbix 6.4 Zabbix 7.0 Zabbix 7.2 Zabbix 7.4	Database upgrade may be slow, depending on the history table size.
2.4.x	For: Zabbix 3.0 Zabbix 3.2 Zabbix 3.4 Zabbix 4.0 Zabbix 4.2 Zabbix 4.4 Zabbix 5.0 Zabbix 5.2 Zabbix 5.4 Zabbix 6.0 Zabbix 6.2 Zabbix 6.4 Zabbix 7.0 Zabbix 7.2 Zabbix 7.4	Minimum required PHP version upped from 5.3.0 to 5.4.0. LogFile agent parameter must be specified.

Upgrade from	Read full upgrade notes	Most important changes between versions
2.2.x LTS	For: Zabbix 2.4 Zabbix 3.0 Zabbix 3.2 Zabbix 3.4 Zabbix 4.0 Zabbix 4.2 Zabbix 4.4 Zabbix 5.0 Zabbix 5.2 Zabbix 5.4 Zabbix 6.0 Zabbix 6.2 Zabbix 6.4 Zabbix 7.0 Zabbix 7.2 Zabbix 7.4	Node-based distributed monitoring removed.
2.0.x	For: Zabbix 2.2 Zabbix 2.4 Zabbix 3.0 Zabbix 3.2 Zabbix 3.4 Zabbix 4.0 Zabbix 4.2 Zabbix 4.4 Zabbix 5.0 Zabbix 5.2 Zabbix 5.4 Zabbix 6.0 Zabbix 6.2 Zabbix 6.4 Zabbix 7.0 Zabbix 7.2 Zabbix 7.4	Minimum required PHP version upped from 5.1.6 to 5.3.0. Case-sensitive MySQL database required for proper server work; character set utf8 and utf8_bin collation is required for Zabbix server to work properly with MySQL database. See database creation scripts . 'mysqli' PHP extension required instead of 'mysql'.

1 Upgrade from sources

Overview

This section provides the steps required for a successful **upgrade** from Zabbix **7.0.x** to Zabbix **7.2.x** using official Zabbix sources.

Warning:

Before the upgrade make sure to read the relevant **upgrade notes**!

You may also want to check the **requirements** for 7.2.

Note:

It may be handy to run two parallel SSH sessions during the upgrade, executing the upgrade steps in one and monitoring the server/proxy logs in another. For example, run `tail -f zabbix_server.log` or `tail -f zabbix_proxy.log` in the second SSH session showing you the latest log file entries and possible errors in real time. This can be critical for production instances.

Server upgrade process

1 Stop server

Stop Zabbix server to make sure that no new data is inserted into database.

2 Back up the existing Zabbix database

This is a very important step. Make sure that you have a backup of your database. It will help if the upgrade procedure fails (lack of disk space, power off, any unexpected problem).

3 Back up configuration files, PHP files and Zabbix binaries

Make a backup copy of Zabbix binaries, configuration files and the PHP file directory.

4 Install new server binaries

Use these [instructions](#) to compile Zabbix server from sources.

5 Review server configuration parameters

Make sure to review [Upgrade notes](#) to check if any changes in the configuration parameters are required.

For new optional parameters, see the [What's new](#) page.

6 Start new Zabbix binaries

Start new binaries. Check log files to see if the binaries have started successfully.

Zabbix server will automatically upgrade the database. When starting up, Zabbix server reports the current (mandatory and optional) and required database versions. If the current mandatory version is older than the required version, Zabbix server automatically executes the required database upgrade patches. The start and progress level (percentage) of the database upgrade is written to the Zabbix server log file. When the upgrade is completed, a "database upgrade fully completed" message is written to the log file. If any of the upgrade patches fail, Zabbix server will not start. Zabbix server will also not start if the current mandatory database version is newer than the required one. Zabbix server will only start if the current mandatory database version corresponds to the required mandatory version.

```
8673:20161117:104750.259 current database version (mandatory/optional): 03040000/03040000
8673:20161117:104750.259 required mandatory version: 03040000
```

Before you start the server:

- Make sure the database user has enough permissions (create table, drop table, create index, drop index)
- Make sure you have enough free disk space.

7 Install new Zabbix web interface

The minimum required PHP version is 8.0.0. Update if needed and follow [installation instructions](#).

8 Clear web browser cookies and cache

After the upgrade you may need to clear web browser cookies and web browser cache for the Zabbix web interface to work properly.

Proxy upgrade process

1 Stop proxy

Stop Zabbix proxy.

2 Back up configuration files and Zabbix proxy binaries

Make a backup copy of the Zabbix proxy binary and configuration file.

3 Install new proxy binaries

Use these [instructions](#) to compile Zabbix proxy from sources.

4 Review proxy configuration parameters

There are no mandatory changes in this version to proxy [parameters](#).

5 Start new Zabbix proxy

Start the new Zabbix proxy. Check log files to see if the proxy has started successfully.

Zabbix proxy will automatically upgrade the database. Database upgrade takes place similarly as when starting [Zabbix server](#).

Agent upgrade process

Attention:

Upgrading agents is not mandatory. You only need to upgrade agents if it is required to access the new functionality.

The upgrade procedure described in this section may be used for upgrading both the Zabbix agent and the Zabbix agent 2.

1 Stop agent

Stop Zabbix agent.

2 Back up configuration files and Zabbix agent binaries

Make a backup copy of the Zabbix agent binary and configuration file.

3 Install new agent binaries

Use these [instructions](#) to compile Zabbix agent from sources.

Alternatively, you may download pre-compiled Zabbix agents from the [Zabbix download page](#).

4 Review agent configuration parameters

There are no mandatory changes in this version neither to [agent](#) nor to [agent 2](#) parameters.

5 Start new Zabbix agent

Start the new Zabbix agent. Check log files to see if the agent has started successfully.

Upgrade between minor versions

When upgrading between minor versions of 7.2.x (for example from 7.2.1 to 7.2.3) it is required to execute the same actions for server/proxy/agent as during the upgrade between major versions. The only difference is that when upgrading between minor versions no changes to the database are made.

2 Upgrade from packages

Overview

This section provides the steps required for a successful [upgrade](#) using official RPM and DEB packages provided by Zabbix for:

- [Red Hat Enterprise Linux](#)
- [Debian/Ubuntu](#)

Zabbix packages from OS repositories

Often, OS distributions (in particular, Debian-based distributions) provide their own Zabbix packages.

Note that these packages are not supported by Zabbix, they are typically out of date and lack the latest features and bug fixes. Only the packages from [repo.zabbix.com](#) are officially supported.

If you are upgrading from packages provided by OS distributions (or had them installed at some point), follow this procedure to switch to official Zabbix packages:

1. Always uninstall the old packages first.
2. Check for residual files that may have been left after deinstallation.
3. Install official packages following [installation instructions](#) provided by Zabbix.

Never do a direct update, as this may result in a broken installation.

1 Red Hat Enterprise Linux

Overview

This section provides instructions on upgrading from Zabbix **7.0.x** to the latest version of Zabbix **7.2.x** using official Zabbix packages for Red Hat Enterprise Linux or its derivatives - AlmaLinux, CentOS Stream, Oracle Linux, and Rocky Linux.

Warning:

Before upgrading, please review the relevant [upgrade notes](#) and ensure that your system meets the [requirements](#) for Zabbix 7.2.

Note:

Consider running two parallel SSH sessions during the upgrade: one for executing the upgrade steps and another for monitoring server/proxy logs. For example, run `tail -f zabbix_server.log` or `tail -f zabbix_proxy.log` in the second session to view the latest log entries and possible errors in real time. This can be critical for production instances.

For instructions on upgrading between Zabbix 7.2.x minor versions (for example, from 7.2.1 to 7.2.3), see [Upgrade between minor versions](#).

Upgrade procedure

1 Stop Zabbix processes

Stop Zabbix server to make sure that no new data is inserted into database:

```
systemctl stop zabbix-server
```

If upgrading Zabbix proxy, agent, or agent 2, stop these components too:

```
systemctl stop zabbix-proxy
systemctl stop zabbix-agent
systemctl stop zabbix-agent2
```

2 Back up Zabbix database

Back up your existing Zabbix database to safeguard against upgrade failures (for example, disk space issues, power loss, or unexpected problems).

3 Back up Zabbix configuration files, PHP files, and Zabbix binaries

Back up existing Zabbix configuration files, PHP files, and Zabbix binaries.

For configuration files, run:

```
mkdir /opt/zabbix-backup/
cp /etc/zabbix/zabbix_server.conf /opt/zabbix-backup/
cp /etc/httpd/conf.d/zabbix.conf /opt/zabbix-backup/
```

For PHP files and Zabbix binaries, run:

```
cp -R /usr/share/zabbix/ /opt/zabbix-backup/
cp -R /usr/share/zabbix-* /opt/zabbix-backup/
```

4 Update repository configuration package

Before proceeding with the upgrade, update your current repository package to the latest version to ensure compatibility with the newest packages and to include any recent security patches or bug fixes.

On **RHEL 9**, run:

```
rpm -Uvh https://repo.zabbix.com/zabbix/7.4/release/rhel/9/noarch/zabbix-release-latest.el9.noarch.rpm
```

On **RHEL 8**, run:

```
rpm -Uvh https://repo.zabbix.com/zabbix/7.4/release/rhel/8/noarch/zabbix-release-latest.el8.noarch.rpm
```

Note:

For older RHEL versions or its derivatives, replace the link above with the correct one from [Zabbix repository](#). Note, however, that packages for those versions may not include all Zabbix components. For a list of components included, see [Zabbix packages](#).

Then, clean up the dnf package manager's cache (including headers, metadata, and package files downloaded during previous installations or updates):

```
dnf clean all
```

On the next dnf operation, dnf will download fresh metadata from the repositories since the old metadata is cleared.

See also: [Known issues](#) for updating the repository configuration package on RHEL.

5 Upgrade Zabbix components

To upgrade Zabbix components, run:

```
dnf install zabbix-server-mysql zabbix-web-mysql zabbix-agent
```

- If using PostgreSQL, replace `mysql` with `pgsql` in the command.
- If upgrading the proxy, replace `server` with `proxy` in the command.
- If upgrading the agent 2, replace `zabbix-agent` with `zabbix-agent2 zabbix-agent2-plugin-*` in the command.

Attention:

Upgrading Zabbix agent 2 with the `dnf install zabbix-agent2` command could lead to an error. For more information, see [Known issues](#).

Then, to upgrade Zabbix frontend with Apache, run:

```
dnf install zabbix-apache-conf
```

6 Review component configuration parameters

Review the relevant [upgrade notes](#) to check if any changes in the configuration parameters are necessary.

For new optional parameters, see the [What's new](#) page.

7 Start Zabbix processes

Start the upgraded Zabbix components:

```
systemctl start zabbix-server
systemctl start zabbix-proxy
systemctl start zabbix-agent
systemctl start zabbix-agent2
```

8 Clear web browser cookies and cache

After the upgrade, you may need to clear web browser cookies and web browser cache for the Zabbix web interface to work properly.

Upgrade between minor versions

It is possible to upgrade between Zabbix 7.2.x minor versions (for example, from 7.2.1 to 7.2.3).

To upgrade all Zabbix components, run:

```
dnf upgrade 'zabbix-*
```

- To upgrade Zabbix server only, replace 'zabbix-*' with 'zabbix-server-*' in the command.
- To upgrade Zabbix proxy only, replace 'zabbix-*' with 'zabbix-proxy-*' in the command.
- To upgrade Zabbix agent only, replace 'zabbix-*' with 'zabbix-agent-*' in the command.
- To upgrade Zabbix agent 2 only, replace 'zabbix-*' with 'zabbix-agent2-*' in the command.

2 Debian/Ubuntu

Overview

This section provides instructions on upgrading from Zabbix **7.0.x** to the latest version of Zabbix **7.2.x** using official Zabbix packages for Debian/Ubuntu.

Warning:

Before upgrading, please review the relevant [upgrade notes](#) and ensure that your system meets the [requirements](#) for Zabbix 7.2.

Note:

Consider running two parallel SSH sessions during the upgrade: one for executing the upgrade steps and another for monitoring server/proxy logs. For example, run `tail -f zabbix_server.log` or `tail -f zabbix_proxy.log` in the second session to view the latest log entries and possible errors in real time. This can be critical for production instances.

For instructions on upgrading between Zabbix 7.2.x minor versions (for example, from 7.2.1 to 7.2.3), see [Upgrade between minor versions](#).

Upgrade procedure

1 Stop Zabbix processes

Stop Zabbix server to make sure that no new data is inserted into database:

```
systemctl stop zabbix-server
```

If upgrading Zabbix proxy, agent, or agent 2, stop these components too:

```
systemctl stop zabbix-proxy
systemctl stop zabbix-agent
systemctl stop zabbix-agent2
```

2 Back up Zabbix database

Back up your existing Zabbix database to safeguard against upgrade failures (for example, disk space issues, power loss, or unexpected problems).

3 Back up Zabbix configuration files, PHP files, and Zabbix binaries

Back up existing Zabbix configuration files, PHP files, and Zabbix binaries.

For configuration files, run:

```
mkdir /opt/zabbix-backup/  
cp /etc/zabbix/zabbix_server.conf /opt/zabbix-backup/  
cp /etc/apache2/conf-enabled/zabbix.conf /opt/zabbix-backup/
```

For PHP files and Zabbix binaries, run:

```
cp -R /usr/share/zabbix/ /opt/zabbix-backup/  
cp -R /usr/share/zabbix-* /opt/zabbix-backup/
```

4 Update repository configuration package

Before proceeding with the upgrade, uninstall your current Zabbix repository package:

```
rm -Rf /etc/apt/sources.list.d/zabbix.list
```

Then, install the latest repository configuration package to ensure compatibility with the newest packages and to include any recent security patches or bug fixes.

On **Debian 12**, run:

```
wget https://repo.zabbix.com/zabbix/7.2/release/debian/pool/main/z/zabbix-release/zabbix-release_latest+de  
dpkg -i zabbix-release_latest+debian12_all.deb
```

Note:

For older Debian versions, replace the link above with the correct one from [Zabbix repository](#). Note, however, that packages for those versions may not include all Zabbix components. For a list of components included, see [Zabbix packages](#).

On **Ubuntu 24.04**, run:

```
wget https://repo.zabbix.com/zabbix/7.2/release/ubuntu/pool/main/z/zabbix-release/zabbix-release_latest+ub  
dpkg -i zabbix-release_latest+ubuntu24.04_all.deb
```

On **Ubuntu 22.04**, run:

```
wget https://repo.zabbix.com/zabbix/7.2/release/ubuntu/pool/main/z/zabbix-release/zabbix-release_latest+ub  
dpkg -i zabbix-release_latest+ubuntu22.04_all.deb
```

Note:

For older Ubuntu versions, replace the link above with the correct one from [Zabbix repository](#). Note, however, that packages for those versions may not include all Zabbix components. For a list of components included, see [Zabbix packages](#).

You may see a prompt about the Zabbix repository configuration:

```
Configuration file '/etc/apt/sources.list.d/zabbix.list'  
==> Deleted (by you or by a script) since installation.  
==> Package distributor has shipped an updated version.  
What would you like to do about it ? Your options are:  
Y or I  : install the package maintainer's version  
N or O  : keep your currently-installed version  
D       : show the differences between the versions  
Z       : start a shell to examine the situation  
The default action is to keep your current version.  
*** zabbix.list (Y/I/N/O/D/Z) [default=N] ?
```

Enter Y (or I) to install the package maintainer's version of the Zabbix repository configuration.

Then, update the repository information:

```
apt update
```

5 Upgrade Zabbix components

To upgrade Zabbix components, run:

```
apt install --only-upgrade zabbix-server-mysql zabbix-frontend-php zabbix-agent
```

- If using PostgreSQL, replace `mysql` with `pgsql` in the command.
- If upgrading proxy, replace `server` with `proxy` in the command.
- If upgrading Zabbix agent 2, replace `zabbix-agent` with `zabbix-agent2 zabbix-agent2-plugin-*` in the command.

Attention:

Upgrading Zabbix agent 2 with the `apt install zabbix-agent2` command could lead to an error. For more information, see [Known issues](#).

You may see a prompt about the Zabbix server (or proxy) configuration:

```
Configuration file '/etc/zabbix/zabbix_server.conf'
==> Modified (by you or by a script) since installation.
==> Package distributor has shipped an updated version.
What would you like to do about it ? Your options are:
Y or I  : install the package maintainer's version
N or O  : keep your currently-installed version
D       : show the differences between the versions
Z       : start a shell to examine the situation
The default action is to keep your current version.
*** zabbix_server.conf (Y/I/N/O/D/Z) [default=N] ?
```

Enter the option that best fits your situation. For example, enter `D` to compare the current and new configuration, then decide if you want to install the package maintainer's version (`Y` or `I`).

Then, to upgrade Zabbix frontend with Apache, run:

```
apt install zabbix-apache-conf
```

6 Review component configuration parameters

Review the relevant [upgrade notes](#) to check if any changes in the configuration parameters are necessary.

For new optional parameters, see the [What's new](#) page.

7 Start Zabbix processes

Start the upgraded Zabbix components:

```
systemctl start zabbix-server
systemctl start zabbix-proxy
systemctl start zabbix-agent
systemctl start zabbix-agent2
```

8 Clear web browser cookies and cache

After the upgrade, you may need to clear web browser cookies and web browser cache for the Zabbix web interface to work properly.

Upgrade between minor versions

It is possible to upgrade between Zabbix 7.2.x minor versions (for example, from 7.2.1 to 7.2.3).

First, update the repository information:

```
apt update
```

Then, to upgrade all Zabbix components, run:

```
apt install --only-upgrade 'zabbix*'
```

- To upgrade Zabbix server only, replace `'zabbix*'` with `'zabbix-server*'` in the command.
- To upgrade Zabbix proxy only, replace `'zabbix*'` with `'zabbix-proxy*'` in the command.
- To upgrade Zabbix agent only, replace `'zabbix*'` with `'zabbix-agent*'` in the command.
- To upgrade Zabbix agent 2 only, replace `'zabbix*'` with `'zabbix-agent2*'` in the command.

3 Upgrade from containers

Overview

This section describes steps required for a successful **upgrade** to Zabbix **7.2.x** containers.

Separate sets of instructions are available for upgrading individual Zabbix component **images** and Docker **compose files**.

Warning:

Before the upgrade make sure to read the relevant **upgrade notes!**

Attention:

Before starting the upgrade, verify that users have the necessary permissions to the database for upgrading purposes.

For upgrades from Zabbix 6.0 or older, deterministic triggers will need to be created during the upgrade. If binary logging is enabled for MySQL/MariaDB, this requires superuser privileges or setting the variable/configuration parameter `log_bin_trust_function_creators = 1`. See **Database creation scripts** for instructions how to set the variable.

Note that if executing from a console, the variable will only be set temporarily and will be dropped when a Docker is restarted. In this case, keep your SQL service running, only stop zabbix-server service by running 'docker compose down zabbix-server' and then 'docker compose up -d zabbix-server'.

Alternatively, you can set this variable in the configuration file.

Depending on the size of a database upgrade to version 7.2 may take quite a long time.

Zabbix image upgrade

The steps listed below can be used to upgrade any Zabbix component. Replace `zabbix-server-mysql` with the required component image name.

1. Check current image version:

```
docker inspect -f '{{ .Config.Image }}' zabbix-server-mysql
```

2. Pull desired image version, for example:

```
docker pull zabbix/zabbix-server-mysql:alpine-7.2-latest
```

`zabbix/zabbix-server-mysql:alpine-7.2-latest` will pull the latest released minor version of Zabbix server 7.2 with MySQL support based on Alpine Linux. Replace it with the name of the Docker repository and tags combination you need. See **Installation from containers** for a list of available options.

3. Stop the container:

```
docker stop zabbix-server-mysql
```

4. Remove the container:

```
docker rm zabbix-server-mysql
```

5. Launch the updated container by executing `docker run` command followed by additional arguments to specify required **environment variables** and/or **mount points**.

Configuration examples

Zabbix server with MySQL:

```
docker run --name zabbix-server-mysql -t \  
  -e DB_SERVER_HOST="mysql-server" \  
  -e MYSQL_DATABASE="zabbix" \  
  -e MYSQL_USER="zabbix" \  
  -e MYSQL_PASSWORD="zabbix_pwd" \  
  -e MYSQL_ROOT_PASSWORD="root_pwd" \  
  -e ZBX_JAVAGATEWAY="zabbix-java-gateway" \  
  --network=zabbix-net \  
  -p 10051:10051 \  
  --restart unless-stopped \  
  -d zabbix/zabbix-server-mysql:alpine-7.2-latest
```

Zabbix server with PostgreSQL:

```
docker run --name zabbix-server-pgsql -t \  
  -e DB_SERVER_HOST="postgres-server" \  
  -e POSTGRES_USER="zabbix" \  
  -e POSTGRES_PASSWORD="zabbix_pwd" \  
  -e ZBX_JAVAGATEWAY="zabbix-java-gateway" \  
  --network=zabbix-net \  
  -p 10051:10051 \  
  --restart unless-stopped \  
  -d zabbix/zabbix-server-pgsql:alpine-7.2-latest
```

```

-e POSTGRES_PASSWORD="zabbix_pwd" \
-e POSTGRES_DB="zabbix" \
-e ZBX_ENABLE_SNMP_TRAPS="true" \
--network=zabbix-net \
-p 10051:10051 \
--volumes-from zabbix-snmptests \
--restart unless-stopped \
-d zabbix/zabbix-server-pgsql:alpine-7.2-latest

```

More configuration examples, including examples for other Zabbix components, are available on the [Installation from containers](#) page.

6. Verify the update:

```
docker logs -f zabbix-server-mysql
```

Compose files

Follow upgrade instructions in this section, if you installed Zabbix using [compose file](#).

1. Check current image version:

```
docker inspect -f '{{ .Config.Image }}' zabbix-server-mysql
```

2. Pull the latest updates from the GitHub [repository](#) and switch to the required branch:

```
git pull
git checkout 7.2
```

3. Start Zabbix components using new compose file:

```
docker-compose -f ./docker-compose_v3_alpine_mysql_latest.yaml up -d
```

4. Verify the update:

```
docker logs -f zabbix-server-mysql
```

See [Installation from containers](#) for more details, including lists of supported environment variables and volume mount points.

8 Known issues

See also: [Compilation issues](#).

Proxy startup with MySQL 8.0.0-8.0.17

zabbix_proxy on MySQL versions 8.0.0-8.0.17 fails with the following "access denied" error:

```
[Z3001] connection to database 'zabbix' failed: [1227] Access denied; you need (at least one of) the SUPER
```

That is due to MySQL 8.0.0 starting to enforce special permissions for setting session variables. However, in 8.0.18 this behavior was removed: [As of MySQL 8.0.18, setting the session value of this system variable is no longer a restricted operation](#).

The workaround is based on granting additional privileges to the zabbix user:

For MySQL versions 8.0.14 - 8.0.17:

```
grant SESSION_VARIABLES_ADMIN on *.* to 'zabbix'@'localhost';
```

For MySQL versions 8.0.0 - 8.0.13:

```
grant SYSTEM_VARIABLES_ADMIN on *.* to 'zabbix'@'localhost';
```

Upgrade

SQL mode setting for successful upgrade

The `sql_mode` setting in MySQL/MariaDB must have the "STRICT_TRANS_TABLES" mode set. If it is absent, the Zabbix database upgrade will fail (see also [ZBX-19435](#)).

Upgrade with MariaDB 10.2.1 and before

Upgrading Zabbix may fail if database tables were created with MariaDB 10.2.1 and before, because in those versions the default row format is compact. This can be fixed by changing the row format to dynamic (see also [ZBX-17690](#)).

Templates

Template compatibility in dual-stack (IPv4/IPv6) environments

In dual-stack environments (systems configured to support both IPv4 and IPv6), the hostname `localhost` typically resolves to both IPv4 and IPv6 addresses. Due to the common prioritization of IPv6 over IPv4 by many operating systems and DNS resolvers, Zabbix templates may fail to work correctly if the service being monitored is configured to listen only on IPv4.

Services that are not configured to listen on IPv6 addresses may become inaccessible, leading to monitoring failures. Users might configure access correctly for IPv4 but still face connectivity issues due to the default behavior of prioritizing IPv6.

A workaround for this is to ensure that the services (Nginx, Apache, PostgreSQL, etc.) are configured to listen on both IPv4 and IPv6 addresses, and Zabbix server/agent is allowed access via IPv6. Additionally, in Zabbix templates and configurations, use `localhost` explicitly instead of `127.0.0.1` to ensure compatibility with both IPv4 and IPv6.

For example, when monitoring PostgreSQL with the [PostgreSQL by Zabbix agent 2](#) template, you may need to edit the `pg_hba.conf` file to allow connections for the `zbx_monitor` user. If the dual-stack environment prioritizes IPv6 (system resolves `localhost` to `::1`) and you configure `localhost` but only add an IPv4 entry (`127.0.0.1/32`), the connection will fail because there is no matching IPv6 entry.

The following `pg_hba.conf` file example ensures that the `zbx_monitor` user can connect to any database from the local machine using both IPv4 and IPv6 addresses with different authentication methods:

```
# TYPE      DATABASE    USER        ADDRESS      METHOD
host       all         zbx_monitor localhost    trust
host       all         zbx_monitor 127.0.0.1/32 md5
host       all         zbx_monitor ::1/128     scram-sha-256
```

If necessary, you can also use the IPv4 address (`127.0.0.1`) directly when configuring the [PostgreSQL by Zabbix agent 2](#) template macro for the connection string.

Accidental installation of EPEL Zabbix packages

With EPEL repository installed and enabled, installing Zabbix from packages will lead to EPEL Zabbix packages being installed rather than official Zabbix packages.

In this case uninstall Zabbix packages from EPEL, i.e.:

```
dnf remove zabbix-server-mysql
```

Block Zabbix packages from EPEL. Add the following line in the `/etc/yum.conf` file:

```
exclude=zabbix7.0*
```

Install Zabbix server again:

```
dnf install zabbix-server-mysql
```

Notice that official Zabbix packages have the word `release` in their version string:

```
7.0.0-release1.el8
```

Zabbix packages for RHEL on Red Hat UBI environments

When installing Zabbix from Red Hat Enterprise Linux packages on [Red Hat Universal Base Image](#) environments, ensure access to required repositories and dependencies. Zabbix packages depend on `libOpenIPMI.so` and `libOpenIPMIposix.so` libraries, which are not provided by any package in the default package manager repositories enabled on UBI systems and will result in installation failures.

The `libOpenIPMI.so` and `libOpenIPMIposix.so` libraries are available in the `OpenIPMI-libs` package, which is provided by the `redhat-#-for-<arch>-appstream-rpms` repository. Access to this repository is curated by subscriptions, which, in the case of UBI environments, get propagated by mounting repository configuration and secrets directories of the RHEL host into the container file-system namespace.

For more information, see [ZBX-24291](#).

Expired signing key for RHEL packages

When upgrading Zabbix on [Red Hat Enterprise Linux](#) or its derivatives, you may encounter an expired signing key issue for packages on [Zabbix repository](#). When a signing key expires, attempts to verify package signatures will result in an error indicating that the certificate or key is no longer valid. For example:

```
error: Verifying a signature using certificate D9AA84C2B617479C6E4FCF4D19F2475308EFA7DD (Zabbix LLC (Jul 2
  1. Certificate 19F2475308EFA7DD invalid: certificate is not alive
     because: The primary key is not live
     because: Expired on 2024-07-04T11:41:23Z
  2. Key 19F2475308EFA7DD invalid: key is not alive
```

```
because: The primary key is not live
because: Expired on 2024-07-04T11:41:23Z
```

To resolve such issues, manually reinstall the latest `zabbix-release` package for your specific variant of RHEL (replace the link below with the correct one from [Zabbix repository](#)).

For example, on **RHEL 9**, run:

```
rpm -Uvh https://repo.zabbix.com/zabbix/7.2/release/rhel/9/noarch/zabbix-release-latest.el9.noarch.rpm
```

Then, update the repository information:

```
dnf update
```

For more information, see [ZBX-24761](#).

Timescale DB: high memory usage with large number of partitions

PostgreSQL versions 9.6-12 use too much memory when updating tables with a large number of partitions. This issue manifests itself when Zabbix updates trends on systems with TimescaleDB if trends are split into relatively small (e.g. 1 day) chunks. This leads to hundreds of chunks present in the trends tables with default housekeeping settings - the condition where PostgreSQL is likely to run out of memory.

The issue has been resolved since Zabbix 5.0.1 for new installations with TimescaleDB, but if TimescaleDB was set up with Zabbix before that, please see [ZBX-16347](#) for the migration notes.

Timescale DB 2.5.0: compression policy can fail on tables that contain integers

This issue manifests when TimescaleDB 2.5.0/2.5.1 is used. It has been resolved since TimescaleDB 2.5.2.

For more information, please see [TimescaleDB Issue #3773](#).

Database TLS connection with MariaDB

Database TLS connection is not supported with the `'verify_ca'` option for the `DBTLSConnect` parameter if MariaDB is used.

Possible deadlocks with MySQL/MariaDB

When running under high load, and with more than one LLD worker involved, it is possible to run into a deadlock caused by an InnoDB error related to the row-locking strategy (see [upstream bug](#)). The error has been fixed in MySQL since 8.0.29, but not in MariaDB. For more details, see [ZBX-21506](#).

Global event correlation

Events may not get correlated correctly if the time interval between the first and second event is very small, i.e. half a second and less.

Numeric (float) data type range with PostgreSQL 11 and earlier

PostgreSQL 11 and earlier versions only support floating point value range of approximately -1.34E-154 to 1.34E+154.

NetBSD 8.0 and newer

Various Zabbix processes may randomly crash on startup on the NetBSD versions 8.X and 9.X. That is due to the too small default stack size (4MB), which must be increased by running:

```
ulimit -s 10240
```

For more information, please see the related problem report: [ZBX-18275](#).

Regular expression limitations in Zabbix agent 2

Zabbix agent 2 does not support lookaheads and lookbehinds in regular expressions due to the standard Go regexp library limitations.

IPMI checks

IPMI checks will not work with the standard OpenIPMI library package on Debian prior to 9 (stretch) and Ubuntu prior to 16.04 (xenial). To fix that, recompile OpenIPMI library with OpenSSL enabled as discussed in [ZBX-6139](#).

SSH checks

- Some Linux distributions like Debian, Ubuntu do not support encrypted private keys (with passphrase) if the `libssh2` library is installed from packages. Please see [ZBX-4850](#) for more details.

- When using libssh 0.9.x on some Linux distributions with OpenSSH 8, SSH checks may occasionally report "Cannot read data from SSH server". This is caused by a libssh [issue](#) ([more detailed report](#)). The error is expected to have been fixed by a stable libssh 0.9.5 release. See also [ZBX-17756](#) for details.
- Using the pipe "|" in the SSH script may lead to a "Cannot read data from SSH server" error. In this case it is recommended to upgrade the libssh library version. See also [ZBX-21337](#) for details.

ODBC checks

- MySQL unixODBC driver should not be used with Zabbix server or Zabbix proxy compiled against MariaDB connector library and vice versa, if possible it is also better to avoid using the same connector as the driver due to an [upstream bug](#). Suggested setup:

PostgreSQL, SQLite or Oracle connector → MariaDB or MySQL unixODBC driver
 MariaDB connector → MariaDB unixODBC driver
 MySQL connector → MySQL unixODBC driver

See [ZBX-7665](#) for more information and available workarounds.

- XML data queried from Microsoft SQL Server may get truncated in various ways on Linux and UNIX systems.
- It has been observed that using ODBC checks for monitoring Oracle databases using various versions of Oracle Instant Client for Linux causes Zabbix server to crash. See also: [ZBX-18402](#), [ZBX-20803](#).
- If using FreeTDS UnixODBC driver, you need to prepend a 'SET NOCOUNT ON' statement to an SQL query (for example, SET NOCOUNT ON DECLARE @strsql NVARCHAR(max) SET @strsql = ...). Otherwise, database monitor item in Zabbix will fail to retrieve the information with an error "SQL query returned empty result". See [ZBX-19917](#) for more information.

Incorrect request method parameter in items

The request method parameter, used only in HTTP checks, may be incorrectly set to '1', a non-default value for all items as a result of upgrade from a pre-4.0 Zabbix version. For details on how to fix this situation, see [ZBX-19308](#).

Web monitoring and HTTP agent

Zabbix server leaks memory on some Linux distributions due to an [upstream bug](#) when "SSL verify peer" is enabled in web scenarios or HTTP agent. Please see [ZBX-10486](#) for more information and available workarounds.

Simple checks

There is a bug in **fping** versions earlier than v3.10 that mishandles duplicate echo replay packets. This may cause unexpected results for `icmping`, `icmpingloss`, `icmpingsec` items. It is recommended to use the latest version of **fping**. Please see [ZBX-11726](#) for more details.

Errors with fping execution in rootless containers

When containers are running in rootless mode or in a specific-restrictions environment, you may face errors related to fping execution when performing ICMP checks, such as `fping: Operation not permitted` or `all packets to all resources lost`.

To fix this problem add `--cap-add=net_raw` to "docker run" or "podman run" commands.

Additionally fping execution in non-root environments may require sysctl modification, i.e.:

```
sudo sysctl -w "net.ipv4.ping_group_range=0 1995"
```

where "1995" is the zabbix GID. For more details, see [ZBX-22833](#).

SNMP checks

If the OpenBSD operating system is used, a use-after-free bug in the Net-SNMP library up to the 5.7.3 version can cause a crash of Zabbix server if the `SourceIP` parameter is set in the Zabbix server configuration file. As a workaround, please do not set the `SourceIP` parameter. The same problem applies also for Linux, but it does not cause Zabbix server to stop working. A local patch for the `net-snmp` package on OpenBSD was applied and will be released with OpenBSD 6.3.

SNMP data spikes

Spikes in SNMP data have been observed that may be related to certain physical factors like voltage spikes in the mains. See [ZBX-14318](#) more details.

SNMP traps

The "net-snmp-perl" package, needed for SNMP traps, has been removed in RHEL 8.0-8.2; re-added in RHEL 8.3.

So if you are using RHEL 8.0-8.2, the best solution is to upgrade to RHEL 8.3.

Please also see [ZBX-17192](#) for more information.

Alert process crash in RHEL 7

Instances of a Zabbix server alert process crash have been encountered in RHEL 7. Please see [ZBX-10461](#) for details.

Upgrading Zabbix agent 2 (6.0.5 or older)

When upgrading Zabbix agent 2 (version 6.0.5 or older) from packages, a plugin-related file conflict error may occur. To fix the error, back up your agent 2 configuration (if necessary), uninstall agent 2 and install it anew.

On RHEL-based systems, run:

```
dnf remove zabbix-agent2
dnf install zabbix-agent2
```

On Debian-based systems, run:

```
apt remove zabbix-agent2
apt install zabbix-agent2
```

For more information, see [ZBX-23250](#).

Flipping frontend locales

It has been observed that frontend locales may flip without apparent logic, i. e. some pages (or parts of pages) are displayed in one language while other pages (or parts of pages) in a different language. Typically the problem may appear when there are several users, some of whom use one locale, while others use another.

A known workaround to this is to disable multithreading in PHP and Apache.

The problem is related to how setting the locale works [in PHP](#): locale information is maintained per process, not per thread. So in a multi-thread environment, when there are several projects run by same Apache process, it is possible that the locale gets changed in another thread and that changes how data can be processed in the Zabbix thread.

For more information, please see related problem reports:

- [ZBX-10911](#) (Problem with flipping frontend locales)
- [ZBX-16297](#) (Problem with number processing in graphs using the `bcdiv` function of BC Math functions)

Graphs

Daylight Saving Time

Changes to Daylight Saving Time (DST) result in irregularities when displaying X axis labels (date duplication, date missing, etc).

Sum aggregation

When using **sum aggregation** in a graph for period that is less than one hour, graphs display incorrect (multiplied) values when data come from trends.

Text overlapping

For some frontend languages (e.g., Japanese), local fonts can cause text overlapping in graph legend. To avoid this, use version 2.3.0 (or later) of PHP GD extension.

Log file monitoring

`log []` and `logrt []` items repeatedly reread log file from the beginning if file system is 100% full and the log file is being appended (see [ZBX-10884](#) for more information).

Slow MySQL queries

Zabbix server generates slow `SELECT` queries in case of non-existing values for items. This [issue](#) is known to occur in MySQL 5.6/5.7 versions (for an extended discussion, see [ZBX-10652](#)), and, in specific cases, may also occur in later MySQL versions. A workaround to this is disabling the [index_condition_pushdown](#) or [prefer_ordering_index](#) optimizer in MySQL. Note, however, that this workaround may not fix all issues related to slow queries.

API login

A large number of open user sessions can be created when using custom scripts with the `user.login method` without a following `user.logout`.

Persistent filter settings from links

When opening a link to Zabbix frontend page that contains filter settings, including the time selector, the filter is automatically saved in the database for the user, replacing the previously saved filter and/or time selector settings for that page. These settings remain active until the user manually updates or resets them.

IPv6 address issue in SNMPv3 traps

Due to a net-snmp bug, IPv6 address may not be correctly displayed when using SNMPv3 in SNMP traps. For more details and a possible workaround, see [ZBX-14541](#).

Trimmed long IPv6 IP address in failed login information

A failed login attempt message will display only the first 39 characters of a stored IP address as that's the character limit in the database field. That means that IPv6 IP addresses longer than 39 characters will be shown incompletely.

Zabbix agent checks on Windows

Non-existing DNS entries in a `Server` parameter of Zabbix agent configuration file (`zabbix_agentd.conf`) may increase Zabbix agent response time on Windows. This happens because Windows DNS caching daemon doesn't cache negative responses for IPv4 addresses. However, for IPv6 addresses negative responses are cached, so a possible workaround to this is disabling IPv4 on the host.

YAML export/import

There are some known issues with YAML [export/import](#):

- Error messages are not translatable;
- Valid JSON with a `.yaml` file extension sometimes cannot be imported;
- Unquoted human-readable dates are automatically converted to Unix timestamps.

Setup wizard on SUSE with NGINX and php-fpm

Frontend setup wizard cannot save configuration file on SUSE with NGINX + php-fpm. This is caused by a setting in `/usr/lib/systemd/system/php-fpm.service` unit, which prevents Zabbix from writing to `/etc`. (introduced in [PHP 7.4](#)).

There are two workaround options available:

- Set the [ProtectSystem](#) option to 'true' instead of 'full' in the php-fpm systemd unit.
- Manually save `/etc/zabbix/web/zabbix.conf.php` file.

Chromium for Zabbix web service on Ubuntu 20

Though in most cases, Zabbix web service can run with Chromium, on Ubuntu 20.04 using Chromium causes the following error:

```
Cannot fetch data: chrome failed to start:cmd_run.go:994:
WARNING: cannot create user data directory: cannot create
"/var/lib/zabbix/snap/chromium/1564": mkdir /var/lib/zabbix: permission denied
Sorry, home directories outside of /home are not currently supported. See https://forum.snapcraft.io/t/112
```

This error occurs because `/var/lib/zabbix` is used as a home directory of user 'zabbix'.

MySQL custom error codes

If Zabbix is used with MySQL installation on Azure, an unclear error message `[9002] Some errors occurred` may appear in Zabbix logs. This generic error text is sent to Zabbix server or proxy by the database. To get more information about the cause of the error, check Azure logs.

Invalid regular expressions after switching to PCRE2

In Zabbix 6.0 support for PCRE2 has been added. Even though PCRE is still supported, Zabbix installation packages for RHEL 7 and newer, SLES (all versions), Debian 9 and newer, Ubuntu 16.04 and newer have been updated to use PCRE2. While providing many benefits, switching to PCRE2 may cause certain existing PCRE regexp patterns becoming invalid or behaving differently. In particular, this affects the pattern `^[w-].`. In order to make this regexp valid again without affecting semantics, change the expression to `^[w-].`. This happens due to the fact that PCRE2 treats the dash sign as a delimiter, creating a range inside a character class.

Geomap widget error

The maps in the Geomap widget may not load correctly, if you have upgraded from an older Zabbix version with NGINX and didn't switch to the new NGINX configuration file during the upgrade.

To fix the issue, you can discard the old configuration file, use the configuration file from the current version package and reconfigure it as described in the [download instructions](#) in section e. *Configure PHP for Zabbix frontend*.

Alternatively, you can manually edit an existing NGINX configuration file (typically, `/etc/zabbix/nginx.conf`). To do so, open the file and locate the following block:

```
location ~ /(api\|/conf[^\.]|include|locale|vendor) {
    deny          all;
    return        404;
}
```

Then, replace this block with:

```
location ~ /(api\|/conf[^\.]|include|locale) {
    deny          all;
    return        404;
}

location /vendor {
    deny          all;
    return        404;
}
```

Use case with global variables shared across webhook calls

As global variables are shared across different webhook calls, the following code will result in the tag value counter gradually increasing:

```
try
{
    aa = aa + 1;
}
catch(e)
{
    aa = 0;
}

result = {
    'tags': {
        'endpoint': aa
    }
};
return JSON.stringify(result);
```

Using local variables instead of global ones is recommended to make sure that each script operates on its own data and that there are no collisions between simultaneous calls.

Processor groups on Windows

Microsoft documentation states that systems with fewer than 64 logical processors always have a single processor group, Group 0. However, Zabbix users have reported a rare bug [ZBX-20260](#), when there are two processor groups on systems with 64 or less logical processors. This resulted in having the “\Processor(n)” performance counters for only one processor group out of two. The actual root cause of this bug is not known. However, a similar case was described at [stackoverflow.com](#), and the root cause there was in interoperation between BIOS and Windows.

1 Compilation issues

These are the known issues regarding Zabbix compilation from sources. For all other cases, see the [Known issues](#) page.

Compiling Zabbix agent on HP-UX

If you install the PCRE library from the popular HP-UX package site <http://hpux.connect.org.uk> (for example, from file `pcre-8.42-ia64_64-11.31.depot`), only the 64-bit version of the library will be installed in the `/usr/local/lib/hpux64` directory.

In this case, for successful agent compilation, a customized option is needed for the `configure` script, for example:

```
CFLAGS="+DD64" ./configure --enable-agent --with-libpcre-include=/usr/local/include --with-libpcre-lib=/usr
```

Library in a non-standard location

Zabbix allows you to specify a library located in a non-standard location. In the example below, Zabbix will run `curl-config` from the specified non-standard location and use its output to determine the correct `libcurl` to use.

```
$ ./configure --enable-server --with-mysql --with-libcurl=/usr/local/bin/curl-config
```

This will work if it is the only `libcurl` installed in the system, but might not if there is another `libcurl` installed in a standard location (by the package manager, for example). Such is the case when you need a newer version of the library for Zabbix and the older one for other applications.

Therefore, specifying a component in a non-standard location will not always work when the same component also exists in a standard location.

For example, if you use a newer libcurl installed in `/usr/local` with the libcurl package still installed, Zabbix might pick up the wrong one and compilation will fail:

```
usr/bin/ld: ../../src/libs/zbxhttp/libzbxhttp.a(http.o): in function 'zbx_http_convert_to_utf8':  
/tmp/zabbix-master/src/libs/zbxhttp/http.c:957: undefined reference to 'curl_easy_header'  
collect2: error: ld returned 1 exit status
```

Here, the function `curl_easy_header()` is not available in the older `/usr/lib/x86_64-linux-gnu/libcurl.so`, but is available in the newer `/usr/local/lib/libcurl.so`.

The problem lies with the order of linker flags, and one solution is to specify the full path to the library in an `LDFLAGS` variable:

```
$ LDFLAGS="-Wl,--no-as-needed /usr/local/lib/libcurl.so" ./configure --enable-server --with-mysql --with-1
```

Note the `-Wl,--no-as-needed` option which might be needed on some systems (see also: default linking options on [Debian-based](#) systems).

9 Template changes

Changes in 7.2.0 New templates

Updated templates

- *VMware* and *VMware FQDN* templates now automatically suppress all problems if a hypervisor is in maintenance mode. To disable problem suppression, set the `{$VMWARE.HYPERVISOR.MAINTENANCE}` macro value to 0.

10 Upgrade notes for 7.4.0

These notes are for upgrading from Zabbix 7.2.x to Zabbix 7.4.0.

All notes are grouped into:

- **Breaking changes** - changes that may break existing installations and other critical information related to the upgrade process
- **Other** - all remaining information describing the changes in Zabbix functionality

See also:

- [Upgrade procedure](#) for all relevant information about upgrading from versions before Zabbix 7.2.0;
- [Upgrading HA cluster](#) for instructions on upgrading servers in a **high-availability** (HA) cluster.

Upgrade process

To complete a successful Zabbix server upgrade on MySQL/MariaDB, you may require to set `GLOBAL log_bin_trust_function_creators = 1` in MySQL if binary logging is enabled, there are no superuser privileges and `log_bin_trust_function_creators = 1` is not set in MySQL configuration file.

To set the variable using the MySQL console, run:

```
mysql> SET GLOBAL log_bin_trust_function_creators = 1;
```

Once the upgrade has been successfully completed, this option can be disabled:

```
mysql> SET GLOBAL log_bin_trust_function_creators = 0;
```

Breaking changes

Other

5 Quickstart

Please use the sidebar to access content in the Quickstart section.

1 Login and configuring user

Overview

In this section, you will learn how to log in and set up a system user in Zabbix.

Login

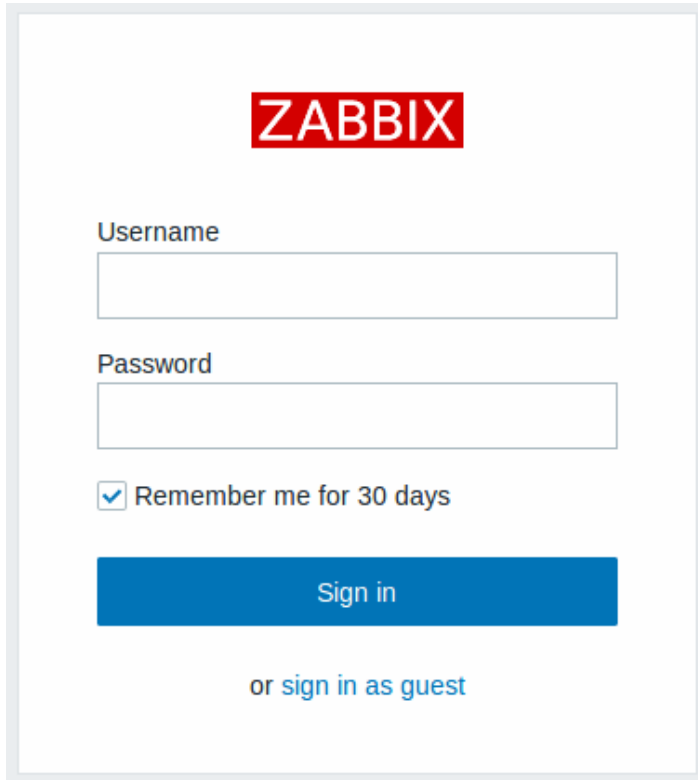

The image shows the Zabbix login interface. At the top, the Zabbix logo is displayed in a red box. Below the logo, there are two input fields: 'Username' and 'Password'. Under the password field, there is a checkbox labeled 'Remember me for 30 days' which is checked. A blue 'Sign in' button is positioned below the checkbox. At the bottom of the form, there is a link that says 'or sign in as guest'.

This is the Zabbix welcome screen. Enter the user name **Admin** with password **zabbix** to log in as a **Zabbix superuser**. Access to all menu sections will be granted.

Protection against brute force attacks

In case of five consecutive failed login attempts, Zabbix interface will pause for 30 seconds in order to prevent brute force and dictionary attacks.

The IP address of a failed login attempt will be displayed after a successful login.

Adding user

To view information about users, go to *Users > Users* in the sidebar's vertical menu.

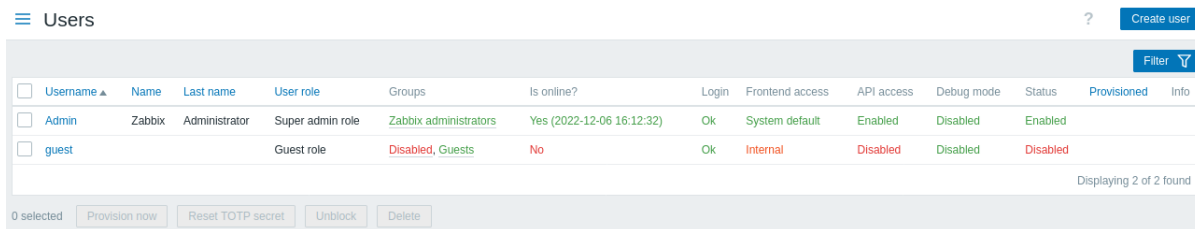

The image shows the 'Users' management page in Zabbix. At the top left, there is a 'Users' header with a hamburger menu icon. At the top right, there is a 'Create user' button. Below the header, there is a table with columns: Username, Name, Last name, User role, Groups, Is online?, Login, Frontend access, API access, Debug mode, Status, Provisioned, and Info. There are two rows of data: 'Admin' and 'guest'. At the bottom of the table, there are buttons for 'Provision now', 'Reset TOTP secret', 'Unblock', and 'Delete'. The text '0 selected' is on the left, and 'Displaying 2 of 2 found' is on the right.

Username	Name	Last name	User role	Groups	Is online?	Login	Frontend access	API access	Debug mode	Status	Provisioned	Info
Admin	Zabbix	Administrator	Super admin role	Zabbix administrators	Yes (2022-12-06 16:12:32)	Ok	System default	Enabled	Disabled	Enabled		
guest			Guest role	Disabled, Guests	No	Ok	Internal	Disabled	Disabled	Disabled		

To add a new user, select *Create user* in the top right corner.

In the new user form, make sure to add your user to one of the existing **user groups**, for example 'Zabbix administrators'.

User Media Permissions

* Username

Name

Last name

Groups
type here to search

* Password

* Password (once again)

Password is not mandatory for non internal authentication type.

Language

Time zone

Theme

Auto-login

Auto-logout

* Refresh

* Rows per page

URL (after login)

All mandatory input fields are marked with a red asterisk. For details about input fields on this configuration form, refer to the [User settings](#) page.

By default, new users have no media (notification delivery methods) defined for them. To create one, go to the 'Media' tab and click on *Add*.

User Media Permissions

Media

Type	Send to	When active	Use if severity	Status	Actions
Add					

In the pop-up, enter the user's email address.

You can specify a time period when the medium will be active (see [Time period specification](#) page for a description of the format). By default a medium is always active. You can also customize [trigger severity](#) levels for which the medium will be active, but leave all of them enabled for now.

Media



Type

* Send to [Remove](#)

[Add](#)

* When active

Use if severity Not classified
 Information
 Warning
 Average
 High
 Disaster

Enabled

Add

Cancel

Click on *Add* to save the medium, then go to the Permissions tab.

Permissions tab has a mandatory field *Role*. The role determines which frontend elements the user can view and which actions he is allowed to perform. Press *Select* and select one of the roles from the list. For example, select *Admin role* to allow access to all Zabbix frontend sections, except Administration. Later on, you can modify permissions or create more user roles. Upon selecting a role, permissions will appear in the same tab:

User Media **Permissions**

* Role

User type

Permissions	Group	Type	Permissions
	All groups	Hosts	None
	All groups	Templates	None

Permissions can be assigned for user groups only.

Access to UI elements

Dashboards

Monitoring

Services

Inventory

Reports

Data collection

Alerts

Access to services

Read-write access to services

Read-only access to services

Access to modules

Access to API

Access to actions

Click *Add* in the user properties form to save the user. The new user appears in the userlist.

<input type="checkbox"/>	Alias ↕	Name	Surname	User role	Groups	Is online?	Login	Frontend access	API access	Debug mode	Status
<input type="checkbox"/>	Admin	Zabbix	Administrator	Super admin role	Zabbix administrators	Yes (2020-10-28 11:42:05)	Ok	System default	Enabled	Enabled	Enabled
<input type="checkbox"/>	guest	John	Snow	User role	Guests	No (2020-07-16 11:06:52)	Ok	System default	Enabled	Disabled	Disabled
<input type="checkbox"/>	user			Admin role	Zabbix administrators	No	Ok	System default	Enabled	Enabled	Enabled

Displaying 3 of 3 found

Adding permissions

By default, a new user has no permissions to access hosts and templates. To grant the user rights, click on the group of the user in the *Groups* column (in this case - 'Zabbix administrators'). In the *User groups* properties form, go to the *Host permissions* tab to assign permissions to host groups. Click on [Add](#) for the host group selection field to be displayed:

Then click on *Select* next to the field to see the list of the host groups. This user is to have read-only access to *Linux servers* group, so mark the appropriate checkbox in the list and click on *Select* to confirm your choice.

Click the *Read* button to set the permission level and then *Update* to save the changes made to the user group configuration.

To grant permissions to templates, you will need to switch to the *Template permissions* tab and specify template groups. The steps are identical to assigning permissions to host groups. An overview of templates is available in the **New template** section of this Quickstart.

Attention:
In Zabbix, access rights to hosts and templates are assigned to **user groups**, not individual users.

Done! You may try to log in using the credentials of the new user.

2 New host

Overview

In this section you will learn how to set up a new host.

A host in Zabbix is a networked entity (physical, virtual) that you wish to monitor. The definition of what can be a "host" in Zabbix is quite flexible. It can be a physical server, a network switch, a virtual machine or some application.

Adding host

Information about configured hosts in Zabbix is available in *Data collection > Hosts* as well as *Monitoring > Hosts* menu sections. There is already one pre-defined host, called "Zabbix server", but we want to learn adding another.

To add a new host, click on *Create host*. This will present us with a host configuration form.

New host

- Host
- IPMI
- Tags
- Macros
- Inventory
- Encryption
- Value mapping

* Host name

Visible name

Templates

* Host groups

Interfaces	Type	IP address	DNS name
Agent		<input type="text" value="127.0.0.1"/>	<input type="text"/>

[Add](#)

Description

All mandatory input fields are marked with a red asterisk.

The bare minimum to enter here is:

Host name

- Enter a host name. Alphanumeric, spaces, dots, dashes and underscores are allowed.

Host groups

- Select one or several existing groups by clicking *Select* button or enter a non-existing group name to create a new group.

Note:

All access permissions are assigned to host groups, not individual hosts. That is why a host must belong to at least one group.

Interfaces: IP address



- Although not a required field technically, a host interface is necessary for collecting certain metrics. To use Zabbix agent passive checks, specify the agent's IP or DNS in this field. Note that you should also specify Zabbix server's IP or DNS in the Zabbix agent configuration file 'Server' directive. If Zabbix agent and Zabbix server are installed on the same machine, you need to specify the same IP/DNS in both places.

Other options will suit us with their defaults for now.

When done, click *Add*. Your new host should be visible in the host list.

<input type="checkbox"/>	Name ▲	Items	Triggers	Graphs	Discovery	Web	Interface	Proxy	Templates	Status	Availability	Agent encryption	Info	Tags
<input type="checkbox"/>	New host	Items	Triggers	Graphs	Discovery	Web	127.0.0.1:10050			Enabled	ZBX	None		

The Availability column contains indicators of host availability per each interface. We have defined a Zabbix agent interface, so we can use the agent availability icon (with 'ZBX' on it) to understand host availability:

-  - host status has not been established; no metric check has happened yet
-  - host is available, a metric check has been successful
-  - host is unavailable, a metric check has failed (move your mouse cursor over the icon to see the error message). There might be some error with communication, possibly caused by incorrect interface credentials. Check that Zabbix server is running, and try refreshing the page later as well.

3 New item

Overview

In this section, you will learn how to set up an item.

Items are the basis of gathering data in Zabbix. Without items, there is no data - because only an item defines a single metric or what kind of data to collect from a host.

Adding item

All items are grouped around hosts. That is why to configure a sample item we go to *Data collection > Hosts* and find the "New host" we have created.

Click on the *Items* link in the row of "New host", and then click on *Create item*. This will present us with an item definition form.

The screenshot shows the 'Create item' form in Zabbix. The form is titled 'Item' and has tabs for 'Tags' and 'Preprocessing'. The form contains several input fields and dropdown menus for configuring an item named 'CPU load'. Mandatory fields are marked with a red asterisk. The 'Name' field is 'CPU load', 'Type' is 'Zabbix agent', 'Key' is 'system.cpu.load', 'Type of information' is 'Numeric (float)', 'Host interface' is '127.0.0.1:10050', and 'Update interval' is '1m'. There is a 'Custom intervals' table with one row: Type 'Flexible', Scheduling 'Scheduling', Interval '50s', Period '1-7,00:00-24:00', and Action 'Remove'. Other fields include 'Timeout' (Global, Override, 3s), 'History' (Do not store, Store up to 90d), and 'Trends' (Do not store, Store up to 365d). At the bottom, there is an 'Enabled' checkbox checked, and 'Add', 'Test', and 'Cancel' buttons.

All mandatory input fields are marked with a red asterisk.

For our sample item, the essential information to enter is:

Name

- Enter *CPU load* as the value. This will be the item name displayed in lists and elsewhere.

Key

- Manually enter *system.cpu.load* as the value. This is the technical name of an item that identifies the type of information that will be gathered. The particular key is just one of **pre-defined keys** that come with Zabbix agent.

Type of information

- This attribute defines the format of the expected data. For the *system.cpu.load* key, this field will be automatically set to *Numeric (float)*.

Note:

You may also want to reduce the number of days **item history** will be kept, to 7 or 14. This is good practice to relieve the database from keeping lots of historical values.

Other options will suit us with their defaults for now.

When done, click *Add*. The new item should appear in the item list, and you should see a success message.

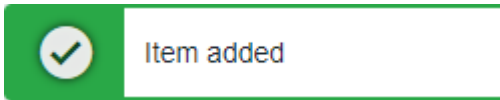

Viewing data

With an item defined, you might be curious if it is actually gathering data. For that, go to *Monitoring > Latest data*, select 'New host' in the filter and click on *Apply*.

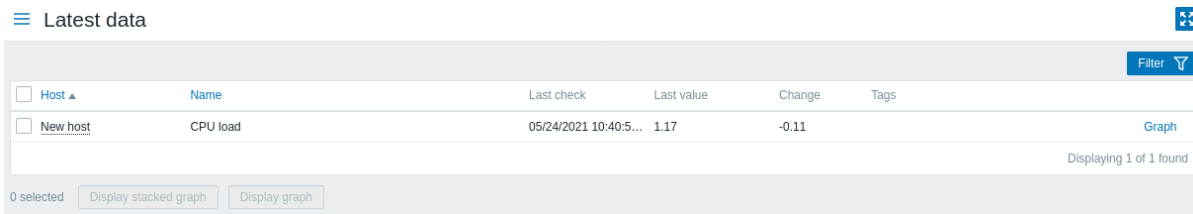

With that said, it may take up to 60 seconds for the first data to arrive. That, by default, is how often the server reads configuration changes and picks up new items to execute.

If you see no value in the 'Change' column, maybe only one value has been received so far. Wait 30 seconds for another value to arrive.

If you do not see information about the item as in the screenshot, make sure that:

- you have filled out the item 'Key' and 'Type of information' fields exactly as in the screenshot;
- both the agent and the server are running;
- host status is 'Monitored' and its availability icon is green;
- the host selected in the host filter is correct;
- the item is enabled.

Graphs

With the item working for a while, it might be time to see something visual. **Simple graphs** are available for any monitored numeric item without any additional configuration. These graphs are generated on runtime.

To view the graph, go to *Monitoring > Latest data* and click on the 'Graph' link next to the item.

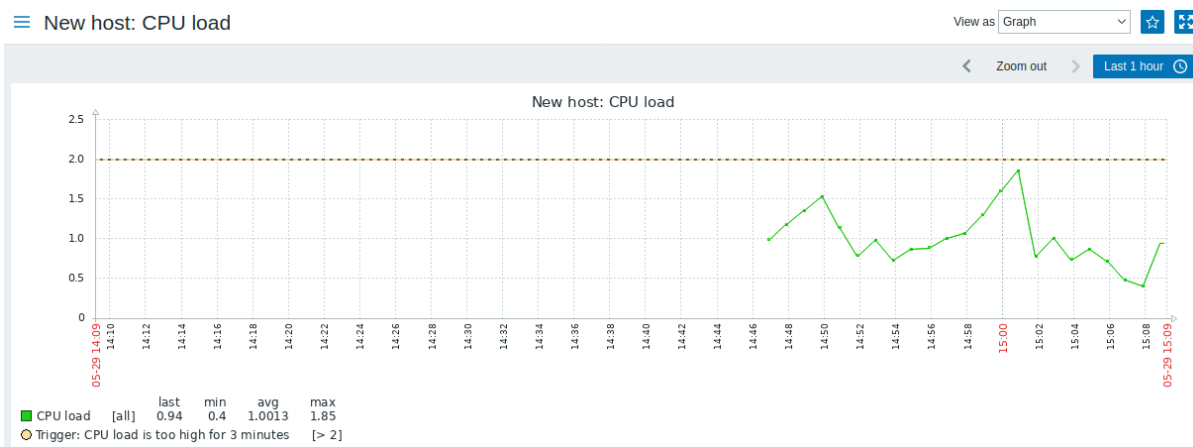

4 New trigger

Overview

In this section you will learn how to set up a trigger.

Items only collect data. To automatically evaluate incoming data we need to define triggers. A trigger contains an expression that defines a threshold of what is an acceptable level for the data.

If that level is surpassed by the incoming data, a trigger will "fire" or go into a 'Problem' state - letting us know that something has happened that may require attention. If the level is acceptable again, trigger returns to an 'Ok' state.

Adding trigger

To configure a trigger for our item, go to *Data collection > Hosts*, find 'New host' and click on *Triggers* next to it and then on *Create trigger*. This presents us with a trigger definition form.

For our trigger, the essential information to enter here is:

Name

- Enter *CPU load too high on 'New host' for 3 minutes* as the value. This will be the trigger name displayed in lists and elsewhere.

Expression

- Enter: `avg(/New host/system.cpu.load,3m)>2`

This is the trigger expression. Make sure that the expression is entered right, down to the last symbol. The item key here (system.cpu.load) is used to refer to the item. This particular expression basically says that the problem threshold is exceeded when the CPU load average value for 3 minutes is over 2. You can learn more about the [syntax of trigger expressions](#).

When done, click *Add*. The new trigger should appear in the trigger list.

Displaying trigger status

With a trigger defined, you might be interested to see its status.

If the CPU load has exceeded the threshold level you defined in the trigger, the problem will be displayed in *Monitoring > Problems*.

Time	<input type="checkbox"/> Severity	Recovery time	Status	Info	Host ▲	Problem	Operational data	Duration
16:23:06	<input type="checkbox"/> Not classified		PROBLEM		New host	CPU load too high on "New host" for 3 minutes	6.6	56s

The flashing in the status column indicates a recent change of trigger status, one that has taken place in the last 30 minutes.

5 Receiving problem notification

Overview

In this section you will learn how to set up alerting in the form of notifications in Zabbix.

With items collecting data and triggers designed to "fire" upon problem situations, it would also be useful to have some alerting mechanism in place that would notify us about important events even when we are not directly looking at Zabbix frontend.

This is what notifications do. Email being the most popular delivery method for problem notifications, we will learn how to set up an email notification.

Email settings

Initially there are several predefined notification **delivery methods** in Zabbix. **Email** is one of those.

To configure email settings, go to *Alerts > Media types* and click on *Email* in the list of pre-defined media types.

☰ Media types

<input type="checkbox"/>	Name ▲	Type	Status	Used in actions	Details
<input type="checkbox"/>	Email	Email	Enabled		SMTP server: "mail.zabbix.com",
<input type="checkbox"/>	Mattermost	Webhook	Enabled		
<input type="checkbox"/>	Opsgenie	Webhook	Enabled		

This will present us with the email settings definition form.

New media type ? X

Media type **Message templates** 5 Options

* Name

Type

Email provider

* SMTP server

SMTP server port

* Email

SMTP helo

Connection security

Authentication

Message format

Description

Enabled

All mandatory input fields are marked with a red asterisk.

In the *Media type* tab, set the values of SMTP server, SMTP helo and SMTP email to the appropriate for your environment.

Note:

'SMTP email' will be used as the 'From' address for the notifications sent from Zabbix.

Next, it is required to define the content of the problem message. The content is defined by means of a message template, configured in the *Message templates* tab.

Click on *Add* to create a message template, and select *Problem* as the message type.

Message template X

Message type

Subject

Message

Click on *Add* when ready and save the form.

Now you have configured 'Email' as a working media type. The media type must also be linked to users by defining specific delivery addresses (like we did when [configuring a new user](#)), otherwise it will not be used.

New action

Delivering notifications is one of the things **actions** do in Zabbix. Therefore, to set up a notification, go to *Alerts > Actions > Trigger actions* and click on *Create action*.

☰ Actions

The screenshot shows the 'Create Action' form in Zabbix. It has two tabs: 'Action' (selected) and 'Operations'. In the 'Action' tab, there is a required field for 'Name' with the value 'Test action'. Below it is a 'Conditions' section with a table that has two columns: 'Label' and 'Name'. There is an 'Add' button below the table. The 'Enabled' checkbox is checked. A message below the checkbox says '* At least one operation must exist.' At the bottom of the form are two buttons: 'Add' and 'Cancel'.

All mandatory input fields are marked with a red asterisk.

In this form, enter a name for the action.

In the most simple case, if we do not add any more specific **conditions**, the action will be taken upon any trigger change from 'Ok' to 'Problem'.

We still should define what the action should do - and that is done in the *Operations* tab. Click on *Add* in the Operations block, which opens a new operation form.

Operation details ✕

Operation **Send message**

Steps - (0 - infinitely)

Step duration (0 - use action default)

*** At least one user or user group must be selected.**

Send to user groups

Send to users

Send to media type ▼

Custom message

Conditions	Label	Name	Action
	Add		

All mandatory input fields are marked with a red asterisk.

Here, click on *Select* in the *Send to Users* block and select the user ('user') we have defined. Select 'Email' as the value of *Send to media type*. When done with this, click on *Add*, and the operation should be added:

☰ Actions

Action
Operations

*** Default operation step duration**

Pause operations for suppressed problems

Operations	Steps	Details	Start in	Duration
	1	Send message to users: user (New User) via Email	Immediately	Default
	Add			

That is all for a simple action configuration, so click *Add* in the action form.

Receiving notification

Now, with delivering notifications configured, it would be fun to actually receive one. To help with that, we might on purpose increase the load on our host - so that our **trigger** "fires" and we receive a problem notification.

Open the console on your host and run:

```
cat /dev/urandom | md5sum
```

You may run one or several of [these processes](#).

Now go to *Monitoring > Latest data* and see how the values of 'CPU Load' have increased. Remember, for our trigger to *fire*, the 'CPU Load' value has to go over '2' for 3 minutes running. Once it does:

- in *Monitoring > Problems* you should see the trigger with a flashing 'Problem' status

- you should receive a problem notification in your email

Attention:

If notifications do not work:

- verify once again that both the email settings and the action have been configured properly
- make sure the user you created has at least read permissions on the host which generated the event, as noted in the *Adding user* step. The user, being part of the 'Zabbix administrators' user group must have at least read access to 'Linux servers' host group that our host belongs to.
- Additionally, you can check out the action log by going to *Reports > Action log*.

6 New template

Overview

In this section you will learn how to set up a template.

Previously we learned how to set up an item, a trigger and how to get a problem notification for the host.

While all of these steps offer a great deal of flexibility in themselves, it may appear like a lot of steps to take if needed for, say, a thousand hosts. Some automation would be handy.

This is where templates come to help. Templates allow to group useful items, triggers and other entities so that those can be reused again and again by applying to hosts in a single step.

When a template is linked to a host, the host inherits all entities of the template. So, basically a pre-prepared bunch of checks can be applied very quickly.

Adding template

To start working with templates, we must first create one. To do that, in *Data collection > Templates* click on *Create template*. This will bring up a template configuration form.

All mandatory input fields are marked with a red asterisk.

The required parameters to enter here are:

Template name

- Enter a template name. Alpha-numericals, spaces and underscores are allowed.

Template groups

- Select one or several groups by clicking *Select* button. The template must belong to a group.

Note:

Access permissions to template groups are assigned in the *user group* configuration on the **Template permissions** tab in the same way as host permissions. All access permissions are assigned to groups, not individual templates, that's why including the template into at least one group is mandatory.

When done, click *Add*. Your new template should be visible in the list of templates. You can also use the *filter* to find your template.

Name	Hosts	Items	Triggers	Graphs	Dashboards	Discovery	Web	Vendor	Version	Linked templates	Linked to templates	Tags
New template	Hosts	Items	Triggers	Graphs	Dashboards	Discovery	Web					

0 selected | Export | Mass update | Delete | Delete and clear

As you may see, the template is there, but it holds nothing in it - no items, triggers or other entities.

Adding item to template

To add an item to the template, open the item list for 'New host' by navigating to *Data collection* → *Hosts* and clicking *Items* next to 'New host'.

Then:

- Mark the checkbox of the 'CPU Load' item in the list.
- Click on *Copy* below the list.
- Select the *Templates* tab.
- Select the template to copy the item to.

Copy 1 item

Target type: Template groups Host groups **Templates** Hosts

* Target: Select

Copy Cancel

All mandatory input fields are marked with a red asterisk.

- Click on *Copy*.

If you now go to *Data collection* > *Templates*, 'New template' should have one new item in it.

We will stop at one item only for now, but similarly you can add any other items, triggers or other entities to the template until it's a fairly complete set of entities for given purpose (monitoring OS, monitoring single application).

Linking template to host

With a template ready, it only remains to add it to a host. For that, go to *Data collection* > *Hosts*, click on 'New host' to open its configuration form and find the **Templates** field.

Start typing *New template* in the *Templates* field. The name of template we have created should appear in the dropdown list. Scroll down to select. See that it appears in the *Templates* field.

Host

Host | IPMI | Tags | Macros | Inventory | Encryption | Value mapping

* Host name:

Visible name:

Templates:

* Host groups:

Click *Update* in the form to save the changes. The template is now added to the host, with all entities that it holds.

This way it can be applied to any other host as well. Any changes to the items, triggers and other entities at the template level will propagate to the hosts the template is linked to.

Linking pre-defined templates to hosts

As you may have noticed, Zabbix comes with a set of predefined templates for various OS, devices and applications. To get started with monitoring very quickly, you may link the appropriate one of them to a host, but beware that these templates need to be fine-tuned for your environment. Some checks may not be needed, and polling intervals may be way too frequent.

More information about [templates](#) is available.

6 Zabbix appliance

Overview Zabbix appliance provides a way to instantly deploy Zabbix server and frontend, instead of setting them up manually or reusing an existing server for Zabbix.

The appliance is based on AlmaLinux 8 (x86_64) and contains a pre-configured Zabbix server running on MySQL and frontend running on Nginx web server.

Attention:

This appliance is designed for evaluating Zabbix. Using it in serious production environments is discouraged.

Appliance images are available for [download](#) in the following formats:

- Installation CD/DVD (.iso)
- VMware (.vmx) - see [notes](#)
- Open virtualization format (.ovf)
- Microsoft Hyper-V (.vhd/.vhdx) - see [notes](#)
- KVM, Parallels, QEMU, USB stick, VirtualBox, Xen (.raw) - see [notes](#)
- KVM, QEMU (.qcow2)

Zabbix installation CD/DVD boot menu:

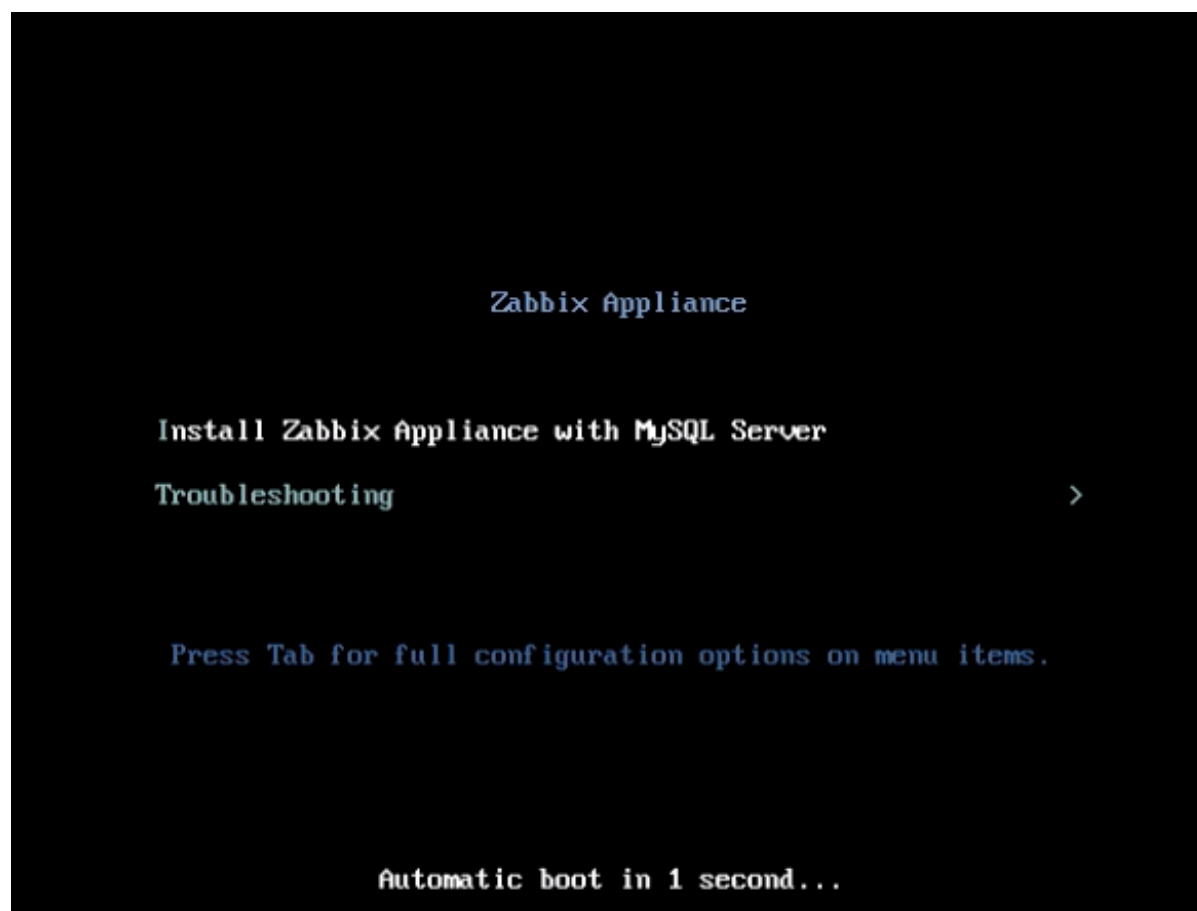

Quick start Pre-requisites

1. Make sure the host machine has sufficient resources to meet the virtual machine's system requirements:
 - RAM: 1.5 GB

- *Disk space*: at least 8 GB should be allocated for the virtual machine
 - *CPU*: 2 cores minimum
2. If not yet installed, install the virtualization software for booting the appliance image (for example, [VirtualBox](#)).
 3. [Download](#) the appliance in the format supported by your virtualization software.
 4. Check network settings to ensure that DHCP is enabled on the host machine.

Installation

1. Boot the appliance virtual machine from the downloaded image.
2. Configure virtual machine network settings to allow access from a browser on the host machine. This can be achieved by enabling *Bridged mode*.
3. Log in to the virtual machine using default system **credentials**.
4. To retrieve the IP address, run the following command on the virtual machine:

```
ip addr show
```

5. Open a browser on the host machine and point it to the IP address the appliance has received over DHCP.
6. Log in to Zabbix using default **credentials** and start monitoring.

Configuration This section describes frequently required default configuration settings along with available customization options.

Credentials

System

- Username: root
- Password: zabbix

Zabbix frontend

- Username: Admin
- Password: zabbix

After logging in, you can change default password in the [user profile settings](#) or [create new users](#) and delete the default one.

Database

Passwords for all database users are randomly generated during the installation process. The following users are defined for the database:

Root:

- Username: root
- Password: the password is stored in the `/root/.my.cnf` file. It is not required to input a password under the root account.

Zabbix server:

- Username: zabbix_srv
- Password: the password is stored in the `/etc/zabbix/zabbix_server.conf`

Zabbix frontend:

- Username: zabbix_web
- Password: the password is stored in the `/etc/zabbix/web/zabbix.conf.php`

To change a database user password, modify it in MySQL and the corresponding configuration file.

Frontend access

Zabbix frontend can be accessed at `http://<virtual machine's IP>`.

By default, access is allowed from anywhere. To limit the access, modify `/etc/nginx/conf.d/zabbix.conf`. After saving the edited file, restart Nginx by logging in via SSH as **root user** and executing:

```
systemctl restart nginx
```

Static IP address

By default, the appliance uses DHCP to obtain the IP address. To set a static IP address:

- Log in as **root user**.

- Run the following commands, replacing values with your custom IP addresses:

```
nmcli connection modify eth0 ipv4.addresses 192.168.1.10/24 # Appliance IP address/CIDR prefix
nmcli connection modify eth0 ipv4.gateway 192.168.1.1 # Gateway IP address
nmcli connection modify eth0 ipv4.dns 8.8.8.8 # DNS server IP address
nmcli connection modify eth0 ipv4.method manual
systemctl restart network
```

Alternatively, you can open the file `/etc/NetworkManager/system-connections/eth0.nmconnection` and add the following lines:

```
[ipv4]
address1=192.168.1.10/24,192.168.1.1
dns=8.8.8.8
method=manual
```

After saving the edited file, run the command `systemctl restart network`.

Firewall configuration

To manage firewall settings, the appliance uses iptables with predefined rules:

- Open SSH port (22 TCP)
- Open Zabbix agent (10050 TCP) and Zabbix trapper (10051 TCP) ports
- Open HTTP (80 TCP) and HTTPS (443 TCP) ports
- Open SNMP trap port (162 UDP)
- Open outgoing connections to NTP port (123 UDP)
- Limit ICMP packets to 5 packets per second
- Drop all other incoming connections

To open additional ports, modify `/etc/sysconfig/iptables` file and reload firewall rules:

```
systemctl reload iptables
```

Repositories

Zabbix appliance uses `zabbix-release` package from the Zabbix [repository](#). Repositories are configured in `/etc/yum.repos.d/*` directory.

Time zone

By default, the appliance uses UTC for the system clock. To change the time zone, copy the appropriate file from `/usr/share/zoneinfo` to `/etc/localtime`, for example:

```
cp /usr/share/zoneinfo/Europe/Riga /etc/localtime
```

Note:

Zabbix **frontend time zone** is set separately and can be changed in the frontend settings. The default time zone for Zabbix frontend is Europe/Riga.

File locations

- Configuration files are located in `/etc/zabbix`
- Zabbix server, proxy, and agent log files are located in `/var/log/zabbix`
- Zabbix frontend is located in `/usr/share/zabbix`
- The home directory for `zabbix` user is `/var/lib/zabbix`

System services

Systemd services are available. To see the list of Zabbix services, run the following command on the virtual machine:

```
systemctl list-units zabbix*
```

Image format-specific notes VMware

The images in `vmdk` format are usable directly in VMware Player, Server, and Workstation products. For use in ESX, ESXi, and vSphere they must be converted using [VMware vCenter Converter](#) (authentication required for download). If you use VMware vCenter Converter, you may encounter issues with the hybrid network adapter. In that case, you can try specifying the E1000 adapter during the conversion process. Alternatively, after the conversion is complete, you can delete the existing adapter and add an E1000 adapter.

HDD/flash image (raw)

To boot the image, run:

```
dd if=./zabbix_appliance_7.0.0.raw of=/dev/sdc bs=4k conv=fdatasync
```

Replace `/dev/sdc` with your Flash/HDD disk device path.

Hyper-V

If the appliance fails to start up in Hyper-V, try pressing **Ctrl+Alt+F2** to switch a TTY session.

Troubleshooting If you encounter the error message *Access denied for user 'replace_user'@'localhost' (using password: YES)* while trying to log in to the frontend, it may indicate that the installation is still in progress.

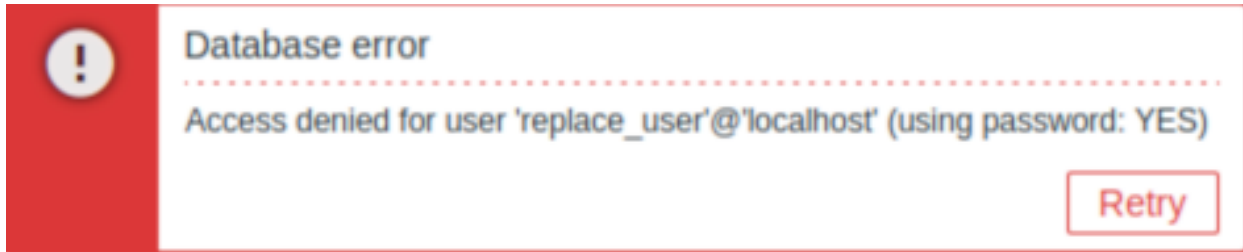

If the error persists after waiting a few minutes, or if you observe any other unexpected behavior, it likely means that the installation process has not completed successfully. In this case, we recommend deleting the current appliance and redeploying it by following the same installation instructions. This step typically resolves the issue.

Note that attempting to manually fix a broken installation is not recommended, as it may lead to further complications.

7 Configuration

Please use the sidebar to access content in the Configuration section.

1 Configuring a template

Overview

Configuring a template requires that you first create a template by defining its general parameters and then you add entities (items, triggers, graphs, etc.) to it.

Creating a template

To create a template, do the following:

1. Go to *Data collection* → *Templates*.
2. Click on *Create template*.
3. Edit template attributes.

The **Template** tab contains general template attributes.

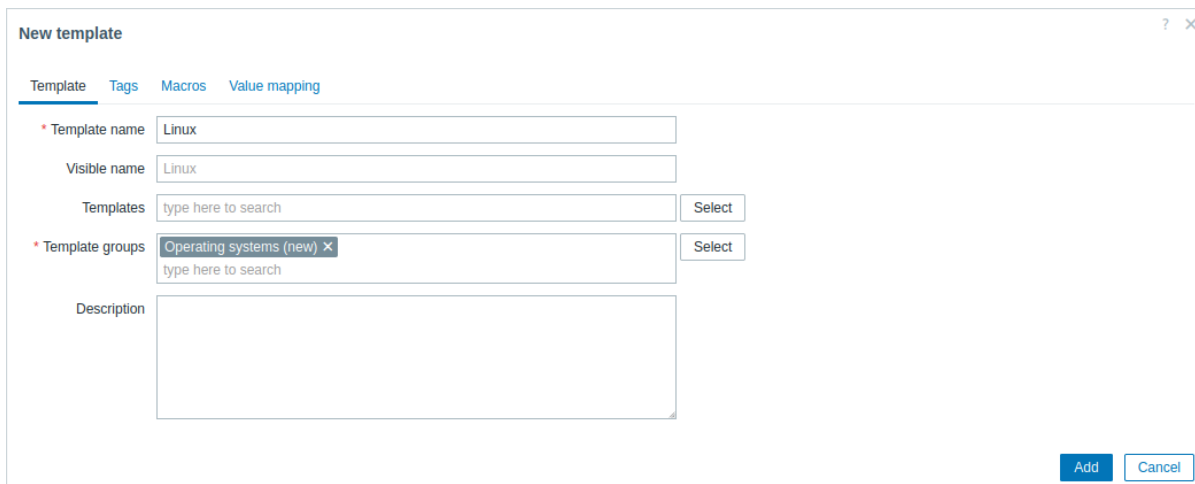

All mandatory input fields are marked with a red asterisk.

Template attributes:

Parameter	Description
<i>Template name</i>	Unique template name. Alphanumerics, spaces, dots, dashes, and underscores are allowed. Leading and trailing spaces are not allowed.
<i>Visible name</i>	If you set this name, it will be the one visible in lists, maps, etc.
<i>Templates</i>	Link one or more templates to this template. All entities (items, triggers, etc.) will be inherited from the linked templates. To link a new template, start typing the template name in the <i>Link new templates</i> field. A list of matching templates will appear; scroll down to select. Alternatively, you may click on <i>Select</i> next to the field and select templates from the list in a pop-up window. The templates that are selected in the <i>Link new templates</i> field will be linked to the template when the template configuration form is saved or updated. To unlink a template, use one of the two options in the <i>Linked templates</i> block: <i>Unlink</i> - unlink the template, but preserve its entities (items, triggers, etc.); <i>Unlink and clear</i> - unlink the template and remove all of its entities (items, triggers, etc.).
<i>Template groups</i>	Groups the template belongs to.
<i>Description</i>	Template description.
<i>Vendor and version</i>	Template vendor and version; displayed only when updating existing templates (out-of-the-box templates provided by Zabbix, imported templates , or templates modified through the Template API) if the template configuration contains such information. Cannot be modified in Zabbix frontend. For out-of-the-box templates, version is displayed as follows: major version of Zabbix, delimiter ("."), revision number (increased with each new version of the template, and reset with each major version of Zabbix). For example, 7.0-0, 7.0-5, 7.2-0, 7.2-3.

The **Tags** tab allows you to define template-level **tags**. All problems of hosts linked to this template will be tagged with the values entered here.

User macros, {INVENTORY.*} macros, {HOST.HOST}, {HOST.NAME}, {HOST.CONN}, {HOST.DNS}, {HOST.IP}, {HOST.PORT} and {HOST.ID} macros are supported in tags.

The **Macros** tab allows you to define template-level **user macros** as a name-value pairs. Note that macro values can be kept as plain text, secret text, or Vault secret. Adding a description is also supported.

If you select the *Inherited and template macros* option, you may also view macros from linked templates and global macros that the template will inherit, as well as the values that the macros will resolve to.

Macro	Effective value	Template value	Global value (configure)
{SAGENT.TIMEOUT}	3m	Change ← Linux: "3m"	
Timeout after which agent is considered unavailable. Works only for agents reachable from Zabbix server/proxy (passive mode).			
{SCPU.UTIL.CRIT}	90	Change ← Linux: "90"	
description			
{\$IFERRORS.WARN}	2	Change ← Linux: "2"	
description			
{IFCONTROL}	1	Change ← Linux: "1"	
description			
{\$SNMP_COMMUNITY}	public	Change	← "public"
description			

Buttons: Add, Cancel

For convenience, links to the respective templates, as well as a link to global macro configuration is provided. It is also possible to edit a linked template macro or global macro on the template level, effectively creating a copy of the macro on the template.

The **Value mapping** tab allows to configure human-friendly representation of item data in **value mappings**.

Buttons:

Add	Add the template. The added template should appear in the list.
Update	Update the properties of an existing template.
Clone	Create another template based on the properties of the current template. This includes the entities (items, triggers, etc.) both inherited from linked templates and directly attached to the current template, but excludes the current template's vendor and version for the cloned template to be distinguishable from the original.
Delete	Delete the template; entities of the template (items, triggers, etc.) remain with the linked hosts.
Delete and clear	Delete the template and all its entities from linked hosts.
Cancel	Cancel the editing of template properties.

Adding items, triggers, graphs

Attention:

Items have to be added to a template first. Triggers and graphs cannot be added without the corresponding item.

There are two ways to add items to the template:

- To create new items, follow the guidelines for **Creating an item**.
- To add existing items to the template:
 - Go to *Data collection* → *Hosts* (or *Templates*).
 - Click on *Items* in the row of the required host/template.

- Mark the checkboxes of items you want to add to the template.
- Click on *Copy* below the item list.
- Select the template (or group of templates) the items should be copied to and click on *Copy*. All the selected items should be copied to the template.

Adding triggers and graphs is done in a similar fashion (from the list of triggers and graphs respectively), again, keeping in mind that they can only be added if the required items are added first.

Adding dashboards

To add dashboards to a template in *Data collection* → *Templates*, do the following:

1. Click on *Dashboards* in the row of the template.
2. Configure a dashboard following the guidelines of [configuring dashboards](#).

Attention:

When configuring widgets on a template dashboard (instead of a global dashboard), the host-related parameters are not available, and some parameters have a different label. This is because template dashboards display data only from the host that the template is linked to. For example, the parameters *Host groups*, *Exclude host groups* and *Hosts* in the *Problems* widget are not available, the parameter *Host groups* in the *Host availability* widget is not available, and the parameter *Show hosts in maintenance* is renamed to *Show data in maintenance*, etc. For more information on the availability of parameters in template dashboard widgets, see specific parameters for each [dashboard widget](#).

Note:

For details on accessing host dashboards that are created from template dashboards, see the [host dashboards](#) section.

Configuring low-level discovery rules

See the [low-level discovery](#) section of the manual.

Adding web scenarios

To add web scenarios to a template in *Data collection* → *Templates*, do the following:

1. Click on *Web* in the row of the template.
2. Configure a web scenario following the usual method of [configuring web scenarios](#).

Creating a template group

Attention:

Only Super Admin users can create template groups.

To create a template group in Zabbix frontend, do the following:

1. Go to: *Data collection* → *Template groups*.
2. Click on *Create template group* in the upper right corner of the screen.
3. Enter the group name in the form.

To create a nested template group, use the '/' forward slash separator, for example `Linux servers/Databases/MySQL`. You can create this group even if none of the two parent template groups (`Linux servers/Databases/`) exist. In this case creating these parent template groups is up to the user; they will not be created automatically. Leading and trailing slashes, several slashes in a row are not allowed. Escaping of '/' is not supported.

Once the group is created, you can click on the group name in the list to edit group name, clone the group or set additional option:

Apply permissions to all subgroups - mark this checkbox and click on *Update* to apply the same level of permissions to all nested template groups. For user groups that may have had differing **permissions** assigned to nested template groups, the permission level of the parent template group will be enforced on the nested groups. This is a one-time option that is not saved in the database.

Permissions to nested template groups:

- When creating a child template group to an existing parent template group, **user group** permissions to the child are inherited from the parent (for example, when creating Databases/MySQL if Databases already exists).
- When creating a parent template group to an existing child template group, no permissions to the parent are set (for example, when creating Databases if Databases/MySQL already exists).

2 Linking/unlinking

Overview

Linking is a process whereby templates are applied to hosts, whereas unlinking removes the association with the template from a host.

Linking a template

To link a template to the host, do the following:

1. Go to *Data collection* → *Hosts*.
2. Click on the required host.
3. Start typing the template name in the *Templates* field. A list of matching templates will appear; scroll down to select. Alternatively, you may click on *Select* next to the field and select one or several templates from the list in a popup window.
4. Click on *Add/Update* in the host attributes form.

The host will now have all the entities of the template. This includes items, triggers, graphs, low-level discovery rules, web scenarios, as well as dashboards.

Attention:

Linking multiple templates to the same host will fail if those templates contain items with the same item key. And, as triggers and graphs use items, they cannot be linked to a single host from multiple templates either, if using identical item keys.

When entities (items, triggers, etc.) are added from the template:

- previously existing identical entities on the host are updated as entities of the template, and **any existing host-level customizations to the entity are lost**;
- entities from the template are added;
- any directly linked entities that, prior to template linkage, existed only on the host remain untouched.

In the lists, all entities from the template now are prefixed by the template name, indicating that these belong to the particular template. The template name itself (in gray text) is a link allowing to access the list of those entities on the template level.

Note:

For some items, such as **external checks**, **HTTP agent checks**, **simple checks**, **SSH checks** and **Telnet checks**, a host interface is optional. If, at the time of linking a template, the host does not have an interface defined these items will be added without an interface. If you add a host interface later it will not be assigned automatically to already existing items. To assign the newly added host interface to all template items at once, **unlink** the template from the host and then link it back again. To preserve item history use the option *Unlink*, do not use *Unlink and clear*.

If some entity is not prefixed by the template name, it means that it existed on the host before and was not added by the template.

Entity uniqueness criteria

When adding entities (items, triggers, etc.) from a template it is important to know what of those entities already exist on the host and need to be updated and what entities differ. The uniqueness criteria for deciding upon the sameness/difference are:

- for items - the item key;
- for triggers - trigger name and expression;
- for custom graphs - graph name and its items.

Linking templates to several hosts

To update template linkage of many hosts, in *Data collection* → *Hosts* select some hosts by marking their checkboxes, then click on **Mass update** below the list and then select *Link templates*:

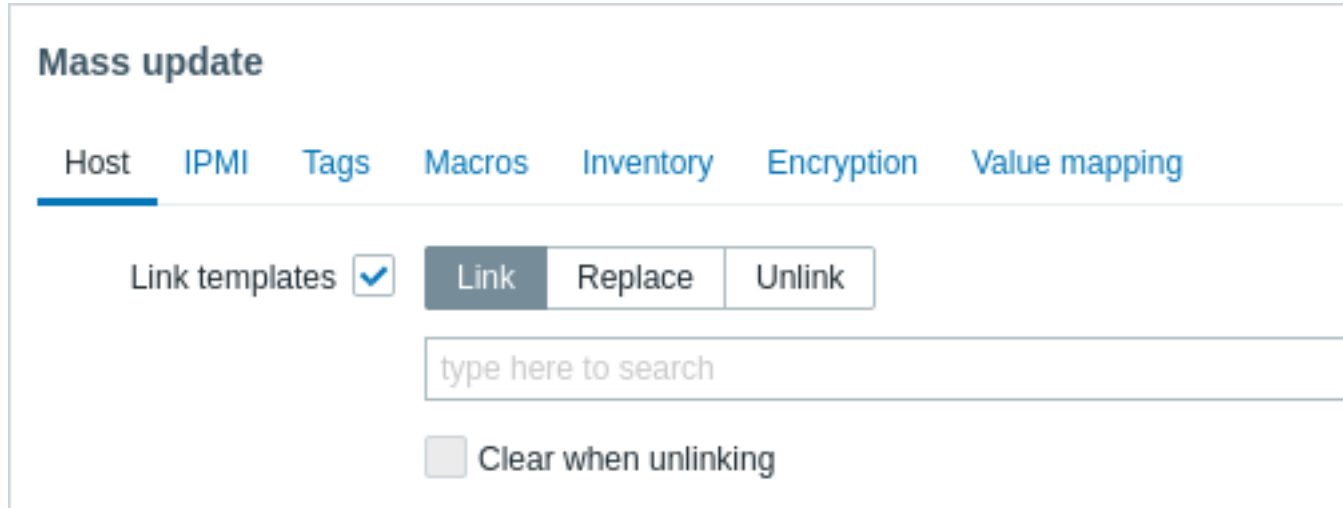

To link additional templates, start typing the template name in the auto-complete field until a dropdown appears offering the matching templates. Just scroll down to select the template to link.

The *Replace* option will allow to link a new template while unlinking any template that was linked to the hosts before. The *Unlink* option will allow to specify which templates to unlink. The *Clear when unlinking* option will allow to not only unlink any previously linked templates, but also remove all entities inherited from them (items, triggers, etc.).

Note:

Zabbix offers a sizable set of predefined templates. You can use these for reference, but beware of using them unchanged in production as they may contain too many items and poll for data too often. If you feel like using them, finetune them to fit your real needs.

Editing linked entities

If you try to edit an item or a trigger that was linked from the template, you may realize that many key options are disabled for editing. This makes sense as the idea of templates is that things are edited in a one-touch manner on the template level. However, you still can, for example, enable/disable an item on individual hosts and set the update interval, history length and some other parameters.

If you want to edit the entity fully, you have to edit it on the template level (template level shortcut is displayed in the form name), keeping in mind that these changes will affect all hosts that have this template linked to them.

Attention:

Any customizations to the entities implemented on a template-level will override the previous customizations of the entities on a host-level.

Unlinking a template

To unlink a template from a host, do the following:

1. Go to *Data collection* → *Hosts*.
2. Click on the required host and find the *Templates* field.
3. Click on *Unlink* or *Unlink and clear* next to the template to unlink the template.
4. Click on *Update* in the host attributes form.

Choosing the *Unlink* option will simply remove association with the template, while leaving all its entities with the host. This includes items, triggers, graphs, low-level discovery rules, and web scenarios, but excludes dashboards. Note that value maps and tags inherited from linked templates will also be removed.

Choosing the *Unlink and clear* option will remove both the association with the template and all its entities (items, triggers, etc.).

3 Nesting

Overview

Nesting is a way of one template encompassing one or more other templates.

As it makes sense to separate out entities on individual templates for various services, applications, etc., you may end up with quite a few templates all of which may need to be linked to quite a few hosts. To simplify the picture, it is possible to link some templates together in a single template.

The benefit of nesting is that you have to link only one template to the host, and the host will automatically inherit all entities from the templates that are linked to the one template. For example, if we link *T1* and *T2* to *T3*, we supplement *T3* with all entities from *T1* and *T2*, but not vice versa. If we link *T1* to *T2* and *T3*, we supplement *T2* and *T3* with entities from *T1*.

Configuring nested templates

To link templates, you need to take an existing template (or create a new one), and then:

1. Open the **template configuration form**.
2. Find the *Templates* field.
3. Click on *Select* to open the *Templates* pop-up window.
4. In the pop-up window, choose the required templates, and then click on *Select* to add the templates to the list.
5. Click on *Add or Update* in the template configuration form.

Thus, all entities of the configured template, as well as all entities of linked templates will now appear in the template configuration. This includes items, triggers, graphs, low-level discovery rules, and web scenarios, but excludes dashboards. However, linked template dashboards will, nevertheless, be inherited by hosts.

To unlink any of the linked templates, click on *Unlink* or *Unlink and clear* in the template configuration form, and then click on *Update*.

The *Unlink* option will simply remove the association with the linked template, while not removing any of its entities (items, triggers, etc.).

The *Unlink and clear* option will remove both the association with the linked template, as well as all its entities (items, triggers, etc.).

4 Mass update

Overview

Sometimes you may want to change some attribute for a number of templates at once. Instead of opening each individual template for editing, you may use the mass update function for that.

Using mass update

To mass-update some templates, do the following:

1. Mark the checkboxes before the templates you want to update in the **template list**.
2. Click on *Mass update* below the list.
3. Navigate to the tab with required attributes (*Template*, *Tags*, *Macros* or *Value mapping*).
4. Mark the checkboxes of any attribute to update and enter a new value for them.

The **Template** tab contains general template mass update options.

Mass update ? X

Template **Tags** Macros Value mapping

Link templates **Link** Replace Unlink

type here to search

Clear when unlinking

Template groups **Add** Replace Remove

type here to search

Description

The following options are available when selecting the respective button for the *Link templates* update:

- *Link* - specify which additional templates to link;
- *Replace* - specify which templates to link while at the same time unlinking any previously linked templates;
- *Unlink* - specify which templates to unlink.

To specify the templates to link/unlink, start typing the template name in the auto-complete field until a dropdown appears offering the matching templates. Just scroll down to select the required templates.

The *Clear when unlinking* option will allow to unlink any previously linked templates, as well as to remove all elements inherited from them (items, triggers, graphs, etc.).

The following options are available when selecting the respective button for the *Template groups* update:

- *Add* - allows to specify additional template groups from the existing ones or enter completely new template groups for the templates;
- *Replace* - will remove the template from any existing template groups and replace them with the one(s) specified in this field (existing or new template groups);
- *Remove* - will remove specific template groups from templates.

These fields are auto-complete - starting to type in them offers a dropdown of matching template groups. If the template group is new, it also appears in the dropdown and it is indicated by *(new)* after the string. Just scroll down to select.

The **Tags** tab allows you to mass update template-level tags.

Mass update ? X

Template **Tags** Macros Value mapping

Tags **Add** Replace Remove

Name	Value	Action
<input type="text" value="tag"/>	<input type="text" value="value"/>	<input type="button" value="Remove"/>

[Add](#)

User macros, {INVENTORY.*} macros, {HOST.HOST}, {HOST.NAME}, {HOST.CONN}, {HOST.DNS}, {HOST.IP}, {HOST.PORT} and {HOST.ID} macros are supported in tags. Note that tags with the same name, but different values are not considered 'duplicates'

and can be added to the same template.

The **Macros** tab allows you to mass update template-level macros.

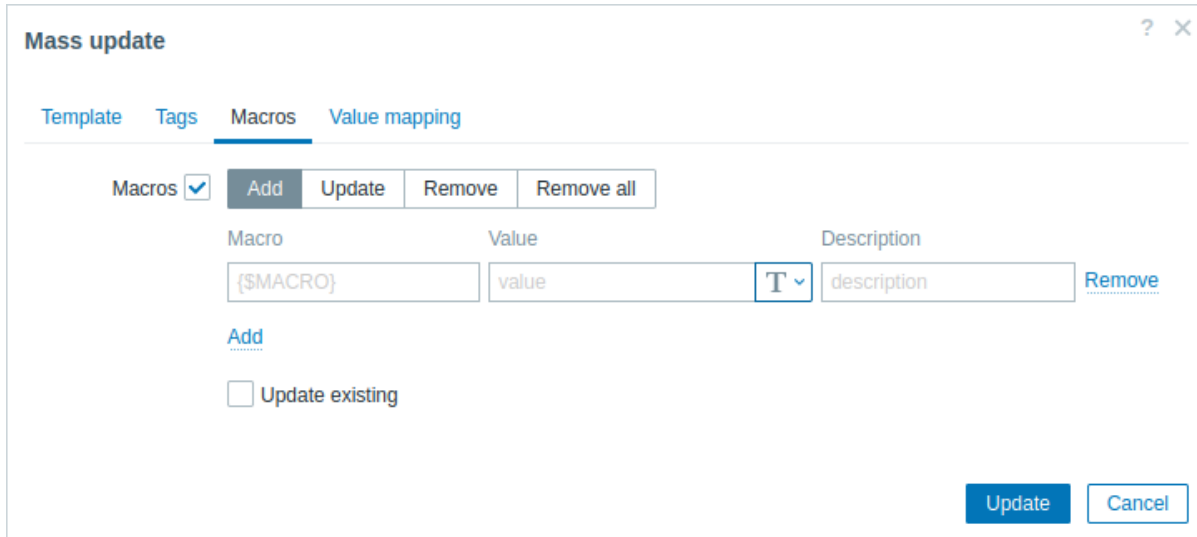

The following options are available when selecting the respective button for macros update:

- *Add* - allows to specify additional user macros for the templates. If *Update existing* checkbox is checked, value, type and description for the specified macro name will be updated. If unchecked, if a macro with that name already exist on the template(s), it will not be updated.
- *Update* - will replace values, types and descriptions of macros specified in this list. If *Add missing* checkbox is checked, macro that didn't previously exist on a template will be added as new macro. If unchecked, only macros that already exist on a template will be updated.
- *Remove* - will remove specified macros from templates. If *Except selected* box is checked, all macros except specified in the list will be removed. If unchecked, only macros specified in the list will be removed.
- *Remove all* - will remove all user macros from templates. If *I confirm to remove all macros* checkbox is not checked, a new popup window will open asking to confirm removal of all macros.

The **Value mapping** tab allows you to mass update **value mappings**.

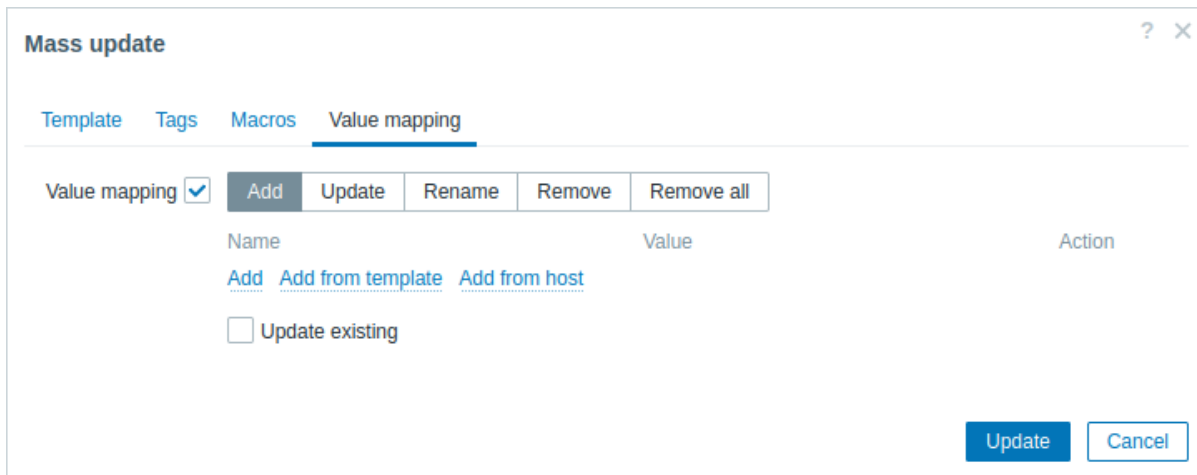

Buttons with the following options are available for value map update:

- *Add* - add value maps to the templates. If you mark *Update existing*, all properties of the value map with this name will be updated. Otherwise, if a value map with that name already exists, it will not be updated.
- *Update* - update existing value maps. If you mark *Add missing*, a value map that didn't previously exist on a template will be added as a new value map. Otherwise only the value maps that already exist on a template will be updated.
- *Rename* - give new name to an existing value map.
- *Remove* - remove the specified value maps from the templates. If you mark *Except selected*, all value maps will be removed **except** the ones that are specified.
- *Remove all* - remove all value maps from the templates. If the *I confirm to remove all value maps* checkbox is not marked, a new popup window will open asking to confirm the removal.

Add from template and *Add from host* options are available for value mapping add/update operations. They allow to select value mappings from a template or a host respectively.

When done with all required changes, click on *Update*. The attributes will be updated accordingly for all the selected templates.

1 Hosts and host groups

What is a "host"?

In Zabbix, a "host" refers to any physical or virtual device, application, service, or any other logically-related collection of monitored parameters.

Creating hosts is one of the first monitoring tasks in Zabbix. For example, if you want to monitor some parameters on a server "x", you must first create a host called, say, "Server X" and then you can look to add monitoring items to it.

Hosts are organized into host groups.

Proceed to [creating and configuring a host](#).

1 Configuring a host

Overview

To configure a host in Zabbix frontend, do the following:

- Go to: *Data collection* → *Hosts* or *Monitoring* → *Hosts*
- Click on *Create host* to the right (or on the host name to edit an existing host)
- Enter parameters of the host in the form

You can also use the *Clone* button in the configuration form of an existing host to create a new host. This host will have all of the properties of the existing host, including linked templates, entities (items, triggers, etc.) from those templates, as well as the entities directly attached to the existing host.

Note that when a host is cloned, it will retain all template entities as they are originally on the template. Any changes to those entities made on the existing host level (such as changed item interval, modified regular expression or added prototypes to the low-level discovery rule) will not be cloned to the new host; instead they will be as on the template.

Configuration

The **Host** tab contains general host attributes:

Host

Host **IPMI** Tags Macros 5 **Inventory** ● Encryption Value mapping

* Host name

Visible name

Templates	Name	Action
	Linux by Zabbix agent	Unlink Unlink and clear
	Zabbix server health	Unlink Unlink and clear

* Host groups

Interfaces	Type	IP address	DNS name
	Agent	<input type="text" value="127.0.0.1"/>	<input type="text"/>
	SNMP	<input type="text" value="127.0.0.1"/>	<input type="text"/>

[Add](#)

Description

Monitored by

Enabled

All mandatory input fields are marked with a red asterisk.

Parameter	Description
<i>Host name</i>	Enter a unique host name. Alphanumerics, spaces, dots, dashes and underscores are allowed. However, leading and trailing spaces are disallowed. <i>Note:</i> With Zabbix agent running on the host you are configuring, the agent configuration file parameter <i>Hostname</i> must have the same value as the host name entered here. The name in the parameter is needed in the processing of active checks .
<i>Visible name</i>	Enter a unique visible name for the host. If you set this name, it will be the one visible in lists, maps, etc instead of the technical host name. This attribute has UTF-8 support.
<i>Templates</i>	Link templates to the host. All entities (items, triggers, <i>etc.</i>) will be inherited from the template. To link a new template, start typing the template name in the text input field. A list of matching templates will appear; scroll down to select. Alternatively, you may click on <i>Select</i> next to the field and select templates from the list in a popup window. All selected templates will be linked to the host when the host configuration form is saved or updated. To unlink a template, use one of the two options in the <i>Linked templates</i> block: <i>Unlink</i> - unlink the template, but preserve its entities (items, triggers, <i>etc.</i>); <i>Unlink and clear</i> - unlink the template and remove all its entities (items, triggers, <i>etc.</i>). Listed template names are clickable links leading to the template configuration form.

Parameter	Description
<i>Host groups</i>	Select host groups the host belongs to. A host must belong to at least one host group. A new group can be created and linked to the host by adding a non-existing group name.
<i>Interfaces</i>	Several host interface types are supported for a host: <i>Agent</i> , <i>SNMP</i> , <i>JMX</i> and <i>IPMI</i> . No interfaces are defined by default. To add a new interface, click on <i>Add</i> in the <i>Interfaces</i> block, select the interface type and enter <i>IP/DNS</i> , <i>Connect to</i> and <i>Port</i> info. <i>Note:</i> Interfaces that are used in any items cannot be removed and link <i>Remove</i> is grayed out for them. See Configuring SNMP monitoring for additional details on configuring an SNMP interface (v1, v2 and v3).
<i>IP address</i>	Host IP address (optional).
<i>DNS name</i>	Host DNS name (optional).
<i>Connect to</i>	Clicking the respective button will tell Zabbix server what to use to retrieve data from agents: IP - Connect to the host IP address (recommended) DNS - Connect to the host DNS name
<i>Port</i>	TCP/UDP port number. Default values are: 10050 for Zabbix agent, 161 for SNMP agent, 12345 for JMX and 623 for IPMI.
<i>Default</i>	Check the radio button to set the default interface.
<i>Description</i>	Enter the host description.
<i>Monitored by</i>	Select if the host is monitored by: Server - host is monitored by Zabbix server; Proxy - host is monitored by standalone proxy; Proxy group - host is monitored by proxy group.
<i>Proxy</i>	The assigned proxy name is displayed (only if Zabbix server has assigned one from the selected proxy group).
<i>Enabled</i>	This field is displayed only if the host is monitored by a proxy group. When the checkbox is checked, the host is enabled - ready for monitoring. When the checkbox is unchecked, the host is disabled - not monitored: For passive data requests initiated by Zabbix server/proxy (for example, Zabbix agent , SNMP agent , simple checks), monitoring stops as soon as you disable the host. For Zabbix agent active checks , monitoring stops within the time frame (approx. 5 seconds) that Zabbix agent receives information about the host having been disabled. During this brief interval, the host will continue to locally collect data for the active checks and try sending it to the server/proxy; however, since the host is marked as <i>Disabled</i> , the server/proxy will reject the data.

The **IPMI** tab contains IPMI management attributes.

Parameter	Description
<i>Authentication algorithm</i>	Select the authentication algorithm.
<i>Privilege level</i>	Select the privilege level.
<i>Username</i>	User name for authentication. User macros may be used.
<i>Password</i>	Password for authentication. User macros may be used.

The **Tags** tab allows you to define host-level **tags**. All problems of this host will be tagged with the values entered here.

Tags	Name	Value
	class	service
	target	jira

User macros, {INVENTORY.*} macros, {HOST.HOST}, {HOST.NAME}, {HOST.CONN}, {HOST.DNS}, {HOST.IP}, {HOST.PORT} and {HOST.ID} macros are supported in tags.

The **Macros** tab allows you to define host-level **user macros** as a name-value pairs. Note that macro values can be kept as plain text, secret text or Vault secret. Adding a description is also supported.

Host IPMI Tags 1 **Macros 2** Inventory ● Encryption Value mapping 1

Host macros Inherited and host macros

Macro	Value	
{\$HOST_MACRO}	1	T ▾
{\$SNMP_COMMUNITY}	public	T ▾

[Add](#)

You may also view here template-level and global user macros if you select the *Inherited and host macros* option. That is where all defined user macros for the host are displayed with the value they resolve to as well as their origin.

Host IPMI Tags 1 **Macros 2** Inventory ● Encryption Value mapping 1

Host macros Inherited and host macros

Macro	Effective value		Templa
{\$AGENT.TIMEOUT}	3m	T ▾	Change ← Templa
Timeout after which agent is considered unavailable. Works only for agents reachable from Zabbix server/proxy (passive mode).			
{\$CPU.UTIL.CRIT}	90	T ▾	Change ← Templa
description			
{\$HOST_MACRO}	1	T ▾	Remove

For convenience, links to respective templates and global macro configuration are provided. It is also possible to edit a template/global macro on the host level, effectively creating a copy of the macro on the host.

The **Inventory** tab allows you to manually enter *inventory* information for the host. You can also select to enable *Automatic* inventory population, or disable inventory population for this host.

Host IPMI Tags 1 **Macros 2** **Inventory ●** Encryption Value mapping 1

Disabled Manual **Automatic**

Type Zabbix server

Type (Full details)

If inventory is enabled (manual or automatic), a green dot is displayed with the tab name.

Encryption

The **Encryption** tab allows you to require *encrypted* connections with the host.

Parameter	Description
<i>Connections to host</i>	How Zabbix server or proxy connects to Zabbix agent on a host: no encryption (default), using PSK (pre-shared key) or certificate.

Parameter	Description
<i>Connections from host</i>	Select what type of connections are allowed from the host (i.e. from Zabbix agent and Zabbix sender). Several connection types can be selected at the same time (useful for testing and switching to other connection type). Default is "No encryption".
<i>Issuer</i>	Allowed issuer of certificate. Certificate is first validated with CA (certificate authority). If it is valid, signed by the CA, then the <i>Issuer</i> field can be used to further restrict allowed CA. This field is intended to be used if your Zabbix installation uses certificates from multiple CAs. If this field is empty then any CA is accepted.
<i>Subject</i>	Allowed subject of certificate. Certificate is first validated with CA. If it is valid, signed by the CA, then the <i>Subject</i> field can be used to allow only one value of <i>Subject</i> string. If this field is empty then any valid certificate signed by the configured CA is accepted.
<i>PSK identity</i>	Pre-shared key identity string. Do not put sensitive information in the PSK identity, it is transmitted unencrypted over the network to inform a receiver which PSK to use.
<i>PSK</i>	Pre-shared key (hex-string). Maximum length: 512 hex-digits (256-byte PSK) if Zabbix uses GnuTLS or OpenSSL library, 64 hex-digits (32-byte PSK) if Zabbix uses mbed TLS (PolarSSL) library. Example: 1f87b595725ac58dd977beef14b97461a7c1045b9a1c963065002c5473194952

Value mapping

The **Value mapping** tab allows to configure human-friendly representation of item data in [value mappings](#).

Creating a host group

Attention:

Only Super Admin users can create host groups.

To create a host group in Zabbix frontend, do the following:

- Go to: *Data collection* → *Host groups*
- Click on *Create host group* in the upper right corner of the screen
- Enter the group name in the form

To create a nested host group, use the '/' forward slash separator, for example Europe/Latvia/Riga/Zabbix servers. You can create this group even if none of the three parent host groups (Europe/Latvia/Riga/) exist. In this case creating these parent host groups is up to the user; they will not be created automatically. Leading and trailing slashes, several slashes in a row are not allowed. Escaping of '/' is not supported.

Once the group is created, you can click on the group name in the list to edit group name, clone the group or set additional option:

Apply permissions and tag filters to all subgroups - mark this checkbox and click on *Update* to apply the same level of permissions/tag filters to all nested host groups. For user groups that may have had differing permissions assigned to nested host groups, the permission level of the parent host group will be enforced on the nested groups. This is a one-time option that is not saved in the database.

Permissions to nested host groups

- When creating a child host group to an existing parent host group, user group permissions to the child are inherited from the parent (for example, when creating Riga/Zabbix servers if Riga already exists)
- When creating a parent host group to an existing child host group, no permissions to the parent are set (for example, when creating Riga if Riga/Zabbix servers already exists)

2 Inventory

Overview

You can keep the inventory of networked devices in Zabbix.

There is a special *Inventory* menu in the Zabbix frontend. However, you will not see any data there initially and it is not where you enter data. Building inventory data is done manually when configuring a host or automatically by using some automatic population options.

Building inventory

Manual mode

When configuring a host, in the *Inventory* tab you can enter such details as the type of device, serial number, location, responsible person, URLs, etc. - data that will populate inventory information.

If a URL is included in host inventory information and it starts with 'http' or 'https', it will result in a clickable link in the *Inventory* section.

Automatic mode

Host inventory can also be populated automatically. For that to work, when configuring a host the inventory mode in the *Inventory* tab must be set to *Automatic*.

Then you can configure host items to populate any host inventory field with their value, indicating the destination field with the respective attribute (called *Item will populate host inventory field*) in item configuration.

Items that are especially useful for automated inventory data collection:

- system.hw.chassis[full|type|vendor|model|serial] - default is [full], root permissions needed
- system.hw.cpu[all|cpunum,full|maxfreq|vendor|model|curfreq] - default is [all,full]
- system.hw.devices[pci|usb] - default is [pci]
- system.hw.macaddr[interface,short|full] - default is [all,full], interface is regexp
- system.sw.arch
- system.sw.os[name|short|full] - default is [name]
- system.sw.packages[regexp,manager,short|full] - default is [all,all,full]

Inventory mode selection

Inventory mode can be selected in the host configuration form.

Inventory mode by default for new hosts is selected based on the *Default host inventory mode* setting in *Administration* → *General* → *Other*.

For hosts added by network discovery or autoregistration actions, it is possible to define a *Set host inventory mode* operation selecting manual or automatic mode. This operation overrides the *Default host inventory mode* setting.

Inventory overview

The details of all existing inventory data are available in the *Inventory* menu.

In *Inventory* → *Overview* you can get a host count by various fields of the inventory.

In *Inventory* → *Hosts* you can see all hosts that have inventory information. Clicking on the host name will reveal the inventory details in a form.

Host inventory

The screenshot shows the 'Overview' tab for a host named 'Zabbix server'. It displays configuration details for Agent and SNMP interfaces, the operating system (OS), and links for monitoring and configuration. A 'Cancel' button is visible at the bottom.

Agent interfaces	IP address	DNS name	Connect to	Port
	127.0.0.1		IP DNS	10050

SNMP interfaces	IP address	DNS name	Connect to	Port
	127.0.0.1		IP DNS	161

OS Linux version 5.3.0-46-generic (buildd@lcy01-amd64-013) (gcc version 7.5.0 (Ubuntu 7.5.0-3ubuntu1~18.04)) #38~18.04.1-Ubuntu SMP

Monitoring [Web](#) [Latest data](#) [Problems](#) [Graphs](#) [Dashboards](#)

Configuration [Host](#) [Items 148](#) [Triggers 67](#) [Graphs 28](#) [Discovery 4](#) [Web 1](#)

[Cancel](#)

The **Overview** tab shows:

Parameter	Description
<i>Host name</i>	Name of the host. Clicking on the name opens a menu with the scripts defined for the host. Host name is displayed with an orange icon, if the host is in maintenance.
<i>Visible name</i>	Visible name of the host (if defined).
<i>Host (Agent, SNMP, JMX, IPMI)
 interfaces</i>	This block provides details of the interfaces configured for the host.
<i>OS</i>	Operating system inventory field of the host (if defined).
<i>Hardware</i>	Host hardware inventory field (if defined).
<i>Software</i>	Host software inventory field (if defined).
<i>Description</i>	Host description.
<i>Monitoring</i>	Links to monitoring sections with data for this host: <i>Web, Latest data, Problems, Graphs, Dashboards</i> .
<i>Configuration</i>	Links to configuration sections for this host: <i>Host, Items, Triggers, Graphs, Discovery, Web</i> . The amount of configured entities is listed after each link.

The **Details** tab shows all inventory fields that are populated (are not empty).

Inventory macros

There are host inventory macros {INVENTORY.*} available for use in notifications, for example:

"Server in {INVENTORY.LOCATION1} has a problem, responsible person is {INVENTORY.CONTACT1}, phone number {INVENTORY.POC.PRIMARY.PHONE.A1}."

For more details, see the [Supported macros](#) page.

3 Mass update

Overview

Sometimes you may want to change some attribute for a number of hosts at once. Instead of opening each individual host for editing, you may use the mass update function for that.

Using mass update

To mass-update some hosts, do the following:

- Mark the checkboxes before the hosts you want to update in the [host list](#)
- Click on *Mass update* below the list
- Navigate to the tab with required attributes (*Host, IPMI, Tags, Macros, Inventory, Encryption* or *Value mapping*)

- Mark the checkboxes of any attribute to update and enter a new value for them

Mass update ? X

Host **IPMI** Tags Macros Inventory Encryption Value mapping

Link templates Link Replace Unlink

type here to search Select

Clear when unlinking

Host groups Add Replace Remove

type here to search Select

Description Original

Monitored by Original

Status Original

Update Cancel

The following options are available when selecting the respective button for **template** linkage update:

- *Link* - specify which additional templates to link
- *Replace* - specify which templates to link while unlinking any template that was linked to the hosts before
- *Unlink* - specify which templates to unlink

To specify the templates to link/unlink start typing the template name in the auto-complete field until a dropdown appears offering the matching templates. Just scroll down to select the required template.

The *Clear when unlinking* option will allow to not only unlink any previously linked templates, but also remove all elements inherited from them (items, triggers, etc.).

The following options are available when selecting the respective button for **host group** update:

- *Add* - allows to specify additional host groups from the existing ones or enter completely new host groups for the hosts
- *Replace* - will remove the host from any existing host groups and replace them with the one(s) specified in this field (existing or new host groups)
- *Remove* - will remove specific host groups from hosts

These fields are auto-complete - starting to type in them offers a dropdown of matching host groups. If the host group is new, it also appears in the dropdown and it is indicated by *(new)* after the string. Just scroll down to select.

Mass update

Host **IPMI** Tags Macros Inventory Encryption Value mapping

Authentication algorithm Original

Privilege level Operator v

Username Original

Password Original

Mass update

Host IPMI **Tags** Macros Inventory Encryption Value mapping

Tags

Add

Replace

Remove

Name

Value

tag

value

[Add](#)

User macros, {INVENTORY.*} macros, {HOST.HOST}, {HOST.NAME}, {HOST.CONN}, {HOST.DNS}, {HOST.IP}, {HOST.PORT} and {HOST.ID} macros are supported in tags. Note that tags with the same name but different values are not considered 'duplicates' and can be added to the same host.

Mass update

Host IPMI Tags **Macros** Inventory Encryption Value mapping

Macros

Add

Update

Remove

Remove all

Macro

Value

Description

{\${MACRO}}

value

T ▾

description

[Add](#)

Update existing

The following options are available when selecting the respective button for macros update:

- *Add* - allows to specify additional user macros for the hosts. If *Update existing* checkbox is checked, value, type and description for the specified macro name will be updated. If unchecked, if a macro with that name already exist on the host(s), it will not be updated.
- *Update* - will replace values, types and descriptions of macros specified in this list. If *Add missing* checkbox is checked, macro that didn't previously exist on a host will be added as new macro. If unchecked, only macros that already exist on a host will be updated.
- *Remove* - will remove specified macros from hosts. If *Except selected* box is checked, all macros except specified in the list will be removed. If unchecked, only macros specified in the list will be removed.
- *Remove all* - will remove all user macros from hosts. If *I confirm to remove all macros* checkbox is not checked, a new popup window will open asking to confirm removal of all macros.

Mass update

Host IPMI Tags Macros Inventory Encryption Value mapping

Inventory mode Disabled Manual **Automatic**

Type Original

Type (Full details) Original

Name Original

Alias Original

To be able to mass update inventory fields, the *Inventory mode* should be set to 'Manual' or 'Automatic'.

Mass update

Host IPMI Tags Macros Inventory Encryption Value mapping

Connections Connections to host No encryption **PSK** Certificate

Connections from host No encryption

PSK

Certificate

* PSK identity

* PSK

Mass update

Host IPMI Tags Macros Inventory Encryption Value mapping

Value mapping **Add** Update Rename Remove Remove all

Name

Value

[Add](#) [Add from](#)

Update existing

Buttons with the following options are available for value map update:

- *Add* - add value maps to the hosts. If you mark *Update existing*, all properties of the value map with this name will be updated. Otherwise, if a value map with that name already exists, it will not be updated.
- *Update* - update existing value maps. If you mark *Add missing*, a value map that didn't previously exist on a host will be added as a new value map. Otherwise only the value maps that already exist on a host will be updated.
- *Rename* - give new name to an existing value map

- *Remove* - remove the specified value maps from the hosts. If you mark *Except selected*, all value maps will be removed **except** the ones that are specified.
- *Remove all* - remove all value maps from the hosts. If the *I confirm to remove all value maps* checkbox is not marked, a new popup window will open asking to confirm the removal.

When done with all required changes, click on *Update*. The attributes will be updated accordingly for all the selected hosts.

2 Items

Overview

An item is an individual metric.

Items are used for collecting data. Once you have configured a host, you must add items to get actual data. One way of quickly adding many items is to attach one of the predefined templates to a host. However, for optimized system performance, you may need to fine-tune the templates to have as many items and as frequent monitoring as necessary.

To specify what sort of data to collect from a host, use the **item key**. For example, an item with the key name **system.cpu.load** will collect processor load data, while an item with the key name **net.if.in** will collect incoming traffic information.

Additional parameters can be specified in square brackets after the key name. For example, **system.cpu.load[avg5]** will return the processor load average for the last 5 minutes, while **net.if.in[eth0]** will show incoming traffic in the interface "eth0".

Note:

See individual sections of **item types** for all supported item types and item keys.

Proceed to **creating and configuring an item**.

1 Creating an item

Overview

To create an item in Zabbix frontend, do the following:

- Go to: *Data collection* → *Hosts*
- Click on *Items* in the row of the host
- Click on *Create item* in the upper right corner of the screen
- Enter parameters of the item in the form

You can also create an item by opening an existing one, pressing the *Clone* button and then saving under a different name.



Configuration

The **Item** tab contains general item attributes.

All mandatory input fields are marked with a red asterisk.

Parameter	Description
<i>Name</i>	Item name. User macros are supported.
<i>Type</i>	Item type. See individual item type sections.
<i>Key</i>	Item key (up to 2048 characters). The supported item keys can be found in individual item type sections. The key must be unique within a single host. If key type is 'Zabbix agent', 'Zabbix agent (active)' or 'Simple check', the key value must be supported by Zabbix agent or Zabbix server. See also: the correct key format .
<i>Type of information</i>	Type of data as stored in the database after performing conversions, if any. Numeric (unsigned) - 64-bit unsigned integer Note that a floating point value, if received for an integer item, will be trimmed from its decimal part. Numeric (float) - 64-bit floating point number This type will allow precision of approximately 15 digits and range from approximately -1.79E+308 to 1.79E+308 (with exception of PostgreSQL 11 and earlier versions). Receiving values in scientific notation is also supported. E.g. 1.23E+7, 1e308, 1.1E-4. Character - short text data Log - long text data with optional log related properties (timestamp, source, severity, logeventid) Text - long text data. See also text data limits . Binary - binary number (supported for dependent items only). A binary number will be resolved to a static "binary value" string in <i>Latest data</i> ; {ITEM.VALUE}, {ITEM.LASTVALUE} and expression macros will resolve to UNKNOWN. For item keys that return data only in one specific format, matching type of information is selected automatically.
<i>Host interface</i>	Select the host interface. This field is available when editing an item on the host level.

Parameter	Description
<i>Units</i>	<p>If a unit symbol is set, Zabbix will add postprocessing to the received value and display it with the set unit postfix.</p> <p>By default, if the raw value exceeds 1000, it is divided by 1000 and displayed accordingly. For example, if you set <i>bps</i> and receive a value of 881764, it will be displayed as 881.76 Kbps. The JEDEC memory standard is used for processing B (byte), Bps (bytes per second) units, which are divided by 1024. Thus, if units are set to B or Bps Zabbix will display:</p> <p>1 as 1B/1Bps 1024 as 1KB/1KBps 1536 as 1.5KB/1.5KBps</p> <p>Special processing is used if the following time-related units are used:</p> <p>unixtime - translated to "yyyy.mm.dd hh:mm:ss". To translate correctly, the received value must be a <i>Numeric (unsigned)</i> type of information.</p> <p>uptime - translated to "hh:mm:ss" or "N days, hh:mm:ss" For example, if you receive the value as 881764 (seconds), it will be displayed as "10 days, 04:56:04"</p> <p>s - translated to "yyy mmm ddd hhh mmm sss ms"; parameter is treated as number of seconds. For example, if you receive the value as 881764 (seconds), it will be displayed as "10d 4h 56m" Only 3 upper major units are shown, like "1m 15d 5h" or "2h 4m 46s". If there are no days to display, only two levels are displayed - "1m 5h" (no minutes, seconds or milliseconds are shown). Will be translated to "< 1 ms" if the value is less than 0.001.</p> <p><i>Note</i> that if a unit is prefixed with !, then no unit prefixes/processing is applied to item values. See unit conversion.</p>
<i>Update interval</i>	<p>Retrieve a new value for this item every N seconds. Maximum allowed update interval is 86400 seconds (1 day).</p> <p>Time suffixes are supported, e.g., 30s, 1m, 2h, 1d.</p> <p>User macros are supported.</p> <p>A single macro has to fill the whole field. Multiple macros in a field or macros mixed with text are not supported.</p> <p><i>Note</i>: The update interval can only be set to '0' if custom intervals exist with a non-zero value. If set to '0', and a custom interval (flexible or scheduled) exists with a non-zero value, the item will be polled during the custom interval duration.</p> <p><i>Note</i> that the first item poll after the item became active or after update interval change might occur earlier than the configured value.</p> <p>New items will be checked within 60 seconds of their creation, unless they have Scheduling or Flexible update interval and the <i>Update interval</i> is set to 0.</p> <p>An existing passive item can be polled for value immediately by pushing the Execute now button.</p>
<i>Custom intervals</i>	<p>You can create custom rules for checking the item:</p> <p>Flexible - create an exception to the <i>Update interval</i> (interval with different frequency)</p> <p>Scheduling - create a custom polling schedule.</p> <p>For detailed information see Custom intervals.</p> <p>Time suffixes are supported in the <i>Interval</i> field, e.g., 30s, 1m, 2h, 1d.</p> <p>User macros are supported.</p> <p>A single macro has to fill the whole field. Multiple macros in a field or macros mixed with text are not supported.</p>
<i>Timeout</i>	<p>Set the item check timeout (available for supported item types). Select the timeout option:</p> <p>Global - proxy/global timeout is used (displayed in the grayed out <i>Timeout</i> field);</p> <p>Override - custom timeout is used (set in the <i>Timeout</i> field; allowed range: 1 - 600s). Time suffixes, e.g. 30s, 1m, and user macros are supported.</p> <p>Clicking the <i>Timeouts</i> link allows you to configure proxy timeouts or global timeouts (if a proxy is not used). Note that the <i>Timeouts</i> link is visible only to users of <i>Super admin</i> type with permissions to <i>Administration</i> → General or <i>Administration</i> → Proxies frontend sections.</p>

Parameter	Description
<i>History</i>	<p>Select either:</p> <p>Do not store - item history is not stored. Useful for master items if only dependent items need to keep history.</p> <p>This setting cannot be overridden by global housekeeper settings.</p> <p>Store up to - specify the duration of keeping detailed history in the database (1 hour to 25 years). Older data will be removed by the housekeeper. Stored in seconds.</p> <p>Time suffixes are supported, e.g., 2h, 1d. User macros are supported.</p> <p>The <i>Store up to</i> value can be overridden globally in <i>Administration</i> → Housekeeping.</p> <p>If a global overriding setting exists, an orange  info icon is displayed. If you position your mouse on it, a warning message is displayed, e.g., <i>Overridden by global housekeeper settings (1d)</i>.</p> <p>It is recommended to keep the recorded values for the smallest possible time to reduce the size of value history in the database. Instead of storing a long history of values, you can store longer data of trends.</p> <p>See also History and trends.</p>
<i>Trends</i>	<p>Select either:</p> <p>Do not store - trends are not stored.</p> <p>This setting cannot be overridden by global housekeeper settings.</p> <p>Store up to - specify the duration of keeping aggregated (hourly min, max, avg, count) history in the database (1 day to 25 years). Older data will be removed by the housekeeper. Stored in seconds.</p> <p>Time suffixes are supported, e.g., 24h, 1d. User macros are supported.</p> <p>The <i>Store up to</i> value can be overridden globally in <i>Administration</i> → Housekeeping.</p> <p>If a global overriding setting exists, an orange  info icon is displayed. If you position your mouse on it, a warning message is displayed, e.g., <i>Overridden by global housekeeper settings (7d)</i>.</p> <p><i>Note:</i> Keeping trends is not available for non-numeric data - character, log and text.</p> <p>See also History and trends.</p>
<i>Value mapping</i>	<p>Apply value mapping to this item. Value mapping does not change received values, it is for displaying data only.</p> <p>It works with <i>Numeric(unsigned)</i>, <i>Numeric(float)</i> and <i>Character</i> items.</p> <p>For example, "Windows service states".</p>
<i>Log time format</i>	<p>Available for items of type Log only. Supported placeholders:</p> <ul style="list-style-type: none"> * y: Year (1970-2038) * M: Month (01-12) * d: Day (01-31) * h: Hour (00-23) * m: Minute (00-59) * s: Second (00-59) <p>If left blank, the timestamp will be set to 0 in Unix time, representing January 1, 1970.</p> <p>For example, consider the following line from the Zabbix agent log file: " 23480:20100328:154718.045 Zabbix agent started. Zabbix 1.8.2 (revision 11211)."</p> <p>It begins with six character positions for PID, followed by date, time, and the rest of the message. The log time format for this line would be "pppppp:yyyyMMdd:hhmmss".</p> <p>Note that "p" and ":" characters are placeholders and can be any characters except "yMdhms".</p>
<i>Populates host inventory field</i>	<p>You can select a host inventory field that the value of item will populate. This will work if automatic inventory population is enabled for the host.</p> <p>This field is not available if <i>Type of information</i> is set to 'Log'.</p>
<i>Description</i>	Enter an item description. User macros are supported.
<i>Enabled</i>	Mark the checkbox to enable the item so it will be processed.
<i>Latest data</i>	Click on the link to view the latest data for the item. This link is only available when editing an already existing item.

Note:

Item type specific fields are described on [corresponding pages](#).

Note:

When editing an existing **template** level item on a host level, a number of fields are read-only. You can use the link in the form header and go to the template level and edit them there, keeping in mind that the changes on a template level will change the item for all hosts that the template is linked to.

The **Tags** tab allows to define item-level **tags**.

Name	Value
component	cpu

Item value preprocessing

The **Preprocessing** tab allows to define **transformation rules** for the received values.

Testing

Attention:

To perform item testing, ensure that the system time on the server and the proxy is **synchronized**. In the case when the server time is behind, item testing may return an error message "The task has been expired." Having set different time zones on the server and the proxy, however, won't affect the testing result.

It is possible to test an item and, if configured correctly, get a real value in return. Testing can occur even before an item is saved.

Testing is available for host and template items, item prototypes and low-level discovery rules. Testing is not available for active items.

Item testing is available for the following passive item types:

- Zabbix agent
- SNMP agent (v1, v2, v3)
- IPMI agent
- SSH checks
- Telnet checks
- JMX agent
- Simple checks (except icmping*, vmware.* items)
- Zabbix internal
- Calculated items
- External checks
- Database monitor
- HTTP agent
- Script
- Browser

To test an item, click on the *Test* button at the bottom of the item configuration form. Note that the *Test* button will be disabled for items that cannot be tested (like active checks, excluded simple checks).

Description

Enabled

The item testing form has fields for the required host parameters (host address, port, test with server/proxy (proxy name)) and item-specific details (such as SNMPv2 community or SNMPv3 security credentials). These fields are context aware:

- The values are pre-filled when possible, i.e., for items requiring an agent, by taking the information from the selected agent interface of the host
- The values have to be filled manually for template items
- Plain-text macro values are resolved
- Fields where the value (or part of the value) is a secret or Vault macro are empty and have to be entered manually. If any item parameter contains a secret macro value, the following warning message is displayed: "Item contains user-defined macros with secret values. Values of these macros should be entered manually."
- The fields are disabled when not needed in the context of the item type (e.g., the host address field and the proxy field are disabled for calculated items)

To test the item, click on *Get value*. If the value is retrieved successfully, it will fill the *Value* field, moving the current value (if any) to the *Previous value* field while also calculating the *Prev. time* field, i.e., the time difference between the two values (clicks) and trying to detect an EOL sequence and switch to CRLF if detecting "\n\r" in retrieved value.

The 'Test item' dialog box contains the following elements:

- Get value from host:**
- Host address:**
- Port:**
- Test with:** Server Proxy
- Get value:**
- Value:**
- Time:**
- Previous value:**
- Prev. time:**
- End of line sequence:** LF CRLF
- Buttons:**

Values retrieved from a host and test results are truncated to a maximum size of 512KB when sent to the frontend. If a result is truncated, a warning icon is displayed. The warning description is displayed on mouseover. Note that data larger than 512KB is still processed fully by Zabbix server.

If the configuration is incorrect, an error message is displayed describing the possible cause.

The 'Test item' dialog box displays an error message at the top:

- Warning:** Invalid second parameter.

The form fields below are:

- Get value from host:**
- Host address:**
- Test with:** Server Proxy
- Value:**

A successfully retrieved value from host can also be used to test [preprocessing steps](#).

Form buttons

Buttons at the bottom of the form allow to perform several operations.

Add	Add an item. This button is only available for new items.
Update	Update the properties of an item.
Clone	Create another item based on the properties of the current item.
Execute now	Execute a check for a new item value immediately. Supported for passive checks only (see more details). <i>Note that when checking for a value immediately, configuration cache is not updated, thus the value will not reflect very recent changes to item configuration.</i>
Test	Test if item configuration is correct by getting a value.
Clear history and trends	Delete the item history and trends.
Delete	Delete the item.
Cancel	Cancel the editing of item properties.

Unit conversion

By default, specifying a unit for an item results in a multiplier prefix being added - for example, an incoming value '2048' with unit 'B' would be displayed as '2KB'.

To prevent a unit from conversion, use the ! prefix, for example, !B. To better understand how the conversion works with and without the exclamation mark, see the following examples of values and units:

```
1024 !B → 1024 B
1024 B → 1 KB
61 !s → 61 s
61 s → 1m 1s
0 !uptime → 0 uptime
0 uptime → 00:00:00
0 !! → 0 !
0 ! → 0
```

Note:

Before Zabbix 4.0, there was a hardcoded unit stoplist consisting of ms, rpm, RPM, %. This stoplist has been deprecated, thus the correct way to prevent converting such units is !ms, !rpm, !RPM, !%.

Text data limits

Text data limits depend on the database backend. Before storing text values in the database they get truncated to match the database value type limit:

Database	Type of information		
	Character	Log	Text
MySQL	255 characters	65536 bytes	65536 bytes
PostgreSQL	255 characters	65536 characters	65536 characters
SQLite (only Zabbix proxy)	255 characters	65536 characters	65536 characters

Custom script limit

Available custom script length depends on the database used:

Database	Limit in characters	Limit in bytes
MySQL	65535	65535
PostgreSQL	65535	not limited
SQLite (only Zabbix proxy)	65535	not limited

Unsupported items

An item can become unsupported if its value cannot be retrieved for some reason (e.g. connection error, no pollers configured to process the item).

Such items are still rechecked at their standard *Update interval*.

Unsupported items are reported as having a NOT SUPPORTED state.

1 Item key format

Item key format, including key parameters, must follow syntax rules. The following illustrations depict the supported syntax. Allowed elements and characters at each point can be determined by following the arrows - if some block can be reached through the line, it is allowed, if not - it is not allowed.

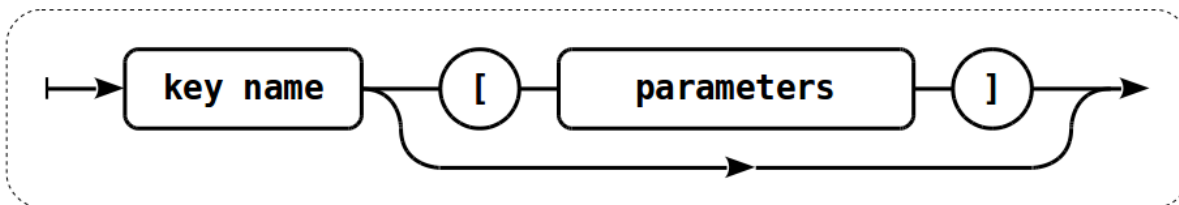

To construct a valid item key, one starts with specifying the key name, then there's a choice to either have parameters or not - as depicted by the two lines that could be followed.

Key name

The key name itself has a limited range of allowed characters, which just follow each other. Allowed characters are:

0-9a-zA-Z_-. .

Which means:

- all numbers;
- all lowercase letters;
- all uppercase letters;
- underscore;
- dash;
- dot.

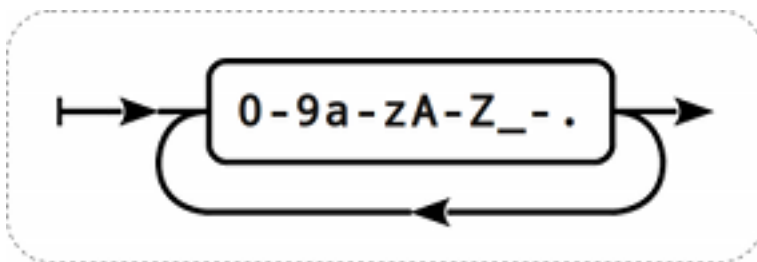

Key parameters

An item key can have multiple parameters that are comma separated.

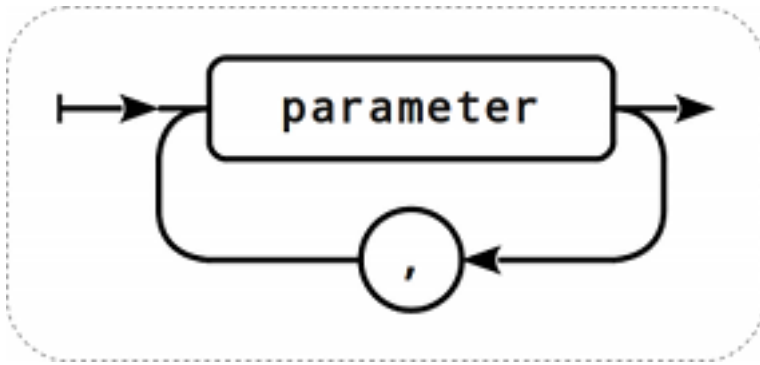

Each key parameter can be either a quoted string, an unquoted string or an array.

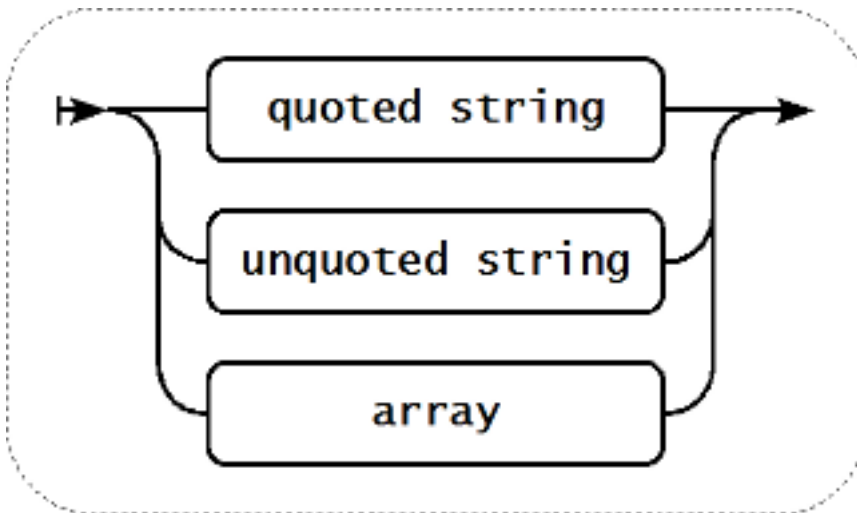

The parameter can also be left empty, thus using the default value. In that case, the appropriate number of commas must be added if any further parameters are specified. For example, item key **icmpping[,200,500]** would specify that the interval between individual pings is 200 milliseconds, timeout - 500 milliseconds, and all other parameters are left at their defaults.

It is possible to include macros in the parameters. Those can be **user macros** or some of the built-in macros. To see what particular built-in macros are supported in item key parameters, search the page **Supported macros** for "item key parameters".

Parameter - quoted string

If the key parameter is a quoted string, any Unicode character is allowed. If the key parameter string contains a quotation mark, this parameter has to be quoted, and each quotation mark which is a part of the parameter string has to be escaped with a backslash (\) character. If the key parameter string contains comma, this parameter has to be quoted.

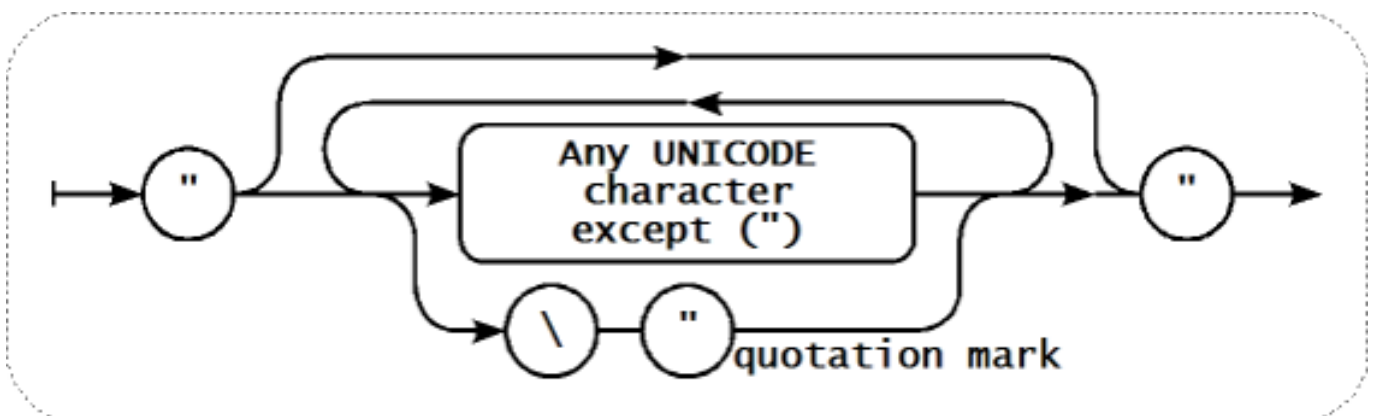

Warning:
To quote item key parameters, use double quotes only. Single quotes are not supported.

Attention:
Multi-level parameter arrays, e.g. [a, [b, [c,d]], e], are not allowed.

Parameter - unquoted string

If the key parameter is an unquoted string, any Unicode character is allowed except comma and right square bracket (]). Unquoted parameter cannot start with left square bracket ([).

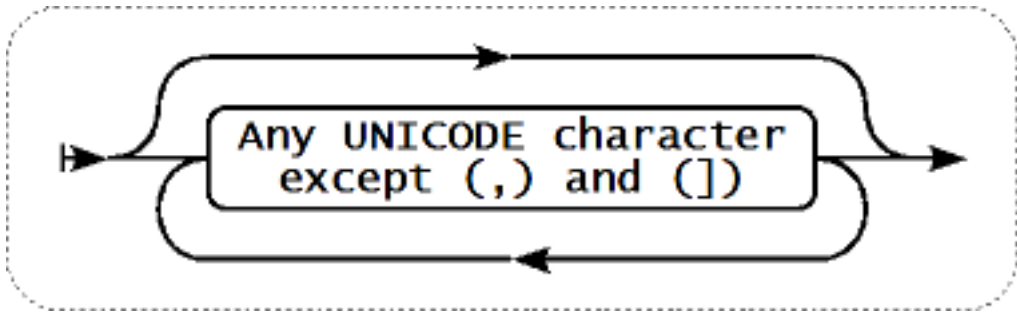

Parameter - array

If the key parameter is an array, it is again enclosed in square brackets, where individual parameters come in line with the rules and syntax of specifying multiple parameters.

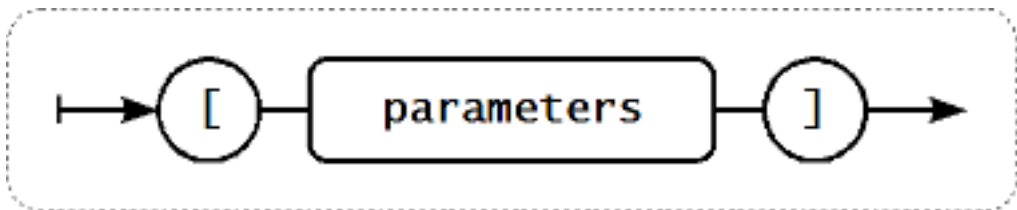

2 Custom intervals

Overview

It is possible to create custom rules regarding the times when an item is checked. The two methods for that are *Flexible intervals*, which allow to redefine the default update interval, and *Scheduling*, whereby an item check can be executed at a specific time or sequence of times.

Flexible intervals

Flexible intervals allow to redefine the default update interval for specific time periods. A flexible interval is defined with *Interval* and *Period* where:

- *Interval* - the update interval for the specified time period
- *Period* - the time period when the flexible interval is active (see the [time periods](#) for detailed description of the *Period* format)

If multiple flexible intervals overlap, the smallest *Interval* value is used for the overlapping period. Note that if the smallest value of overlapping flexible intervals is '0', no polling will take place. Outside the flexible intervals the default update interval is used.

Note that if the flexible interval equals the length of the period, the item will be checked exactly once. If the flexible interval is greater than the period, the item might be checked once or it might not be checked at all (thus such configuration is not advisable). If the flexible interval is less than the period, the item will be checked at least once.

If the flexible interval is set to '0', the item is not polled during the flexible interval period and resumes polling according to the default *Update interval* once the period is over. Examples:

Interval	Period	Description
10	1-5,09:00-18:00	Item will be checked every 10 seconds during working hours.
0	1-7,00:00-7:00	Item will not be checked during the night.
0	7-7,00:00-24:00	Item will not be checked on Sundays.
60	1-7,12:00-12:01	Item will be checked at 12:00 every day. Note that this was used as a workaround for scheduled checks and it is recommended to use scheduling intervals for such checks.

Scheduling intervals

Scheduling intervals are used to check items at specific times. While flexible intervals are designed to redefine the default item update interval, the scheduling intervals are used to specify an independent checking schedule, which is executed in parallel.

A scheduling interval is defined as: `md<filter>wd<filter>h<filter>m<filter>s<filter>` where:

- **md** - month days

- **wd** - week days
- **h** - hours
- **m** - minutes
- **s** - seconds

<filter> is used to specify values for its prefix (days, hours, minutes, seconds) and is defined as: [<from>[-<to>]] [/<step>] [, <filter>] where:

- <from> and <to> define the range of matching values (included). If <to> is omitted then the filter matches a <from> - <from> range. If <from> is also omitted then the filter matches all possible values.
- <step> defines the skips of the number value through the range. By default <step> has the value of 1, which means that all values of the defined range are matched.

While the filter definitions are optional, at least one filter must be used. A filter must either have a range or the <step> value defined.

An empty filter matches either '0' if no lower-level filter is defined or all possible values otherwise. For example, if the hour filter is omitted then only '0' hour will match, provided minute and seconds filters are omitted too, otherwise an empty hour filter will match all hour values.

Valid <from> and <to> values for their respective filter prefix are:

Prefix	Description	<from>	<to>
md	Month days	1-31	1-31
wd	Week days	1-7	1-7
h	Hours	0-23	0-23
m	Minutes	0-59	0-59
s	Seconds	0-59	0-59

The <from> value must be less or equal to <to> value. The <step> value must be greater or equal to 1 and less or equal to <to> - <from>.

Single digit month days, hours, minutes and seconds values can be prefixed with 0. For example md01-31 and h/02 are valid intervals, but md01-031 and wd01-07 are not.

In Zabbix frontend, multiple scheduling intervals are entered in separate rows. In Zabbix API, they are concatenated into a single string with a semicolon ; as a separator.

If a time is matched by several intervals it is executed only once. For example, wd1h9;h9 will be executed only once on Monday at 9am.

Examples:

Interval	Will be executed
m0-59	every minute
h9-17/2	every 2 hours starting with 9:00 (9:00, 11:00 ...)
m0,30 or m/30	hourly at hh:00 and hh:30
m0,5,10,15,20,25,30,35,40,45,50,55 or m/5	every five minutes
wd1-5h9	every Monday till Friday at 9:00
wd1-5h9-18	every Monday till Friday at 9:00,10:00,...,18:00
h9,10,11 or h9-11	every day at 9:00, 10:00 and 11:00
md1h9m30	every 1st day of each month at 9:30
md1wd1h9m30	every 1st day of each month at 9:30 if it is Monday
h9m/30	every day at 9:00, 9:30
h9m0-59/30	every day at 9:00, 9:30
h9,10m/30	every day at 9:00, 9:30, 10:00, 10:30
h9-10m30	every day at 9:30, 10:30
h9m10-40/30	every day at 9:10, 9:40
h9,10m10-40/30	every day at 9:10, 9:40, 10:10, 10:40
h9-10m10-40/30	every day at 9:10, 9:40, 10:10, 10:40
h9m10-40	every day at 9:10, 9:11, 9:12, ... 9:40
h9m10-40/1	every day at 9:10, 9:11, 9:12, ... 9:40
h9-12,15	every day at 9:00, 10:00, 11:00, 12:00, 15:00
h9-12,15m0	every day at 9:00, 10:00, 11:00, 12:00, 15:00

Interval	Will be executed
h9-12,15m0s30	every day at 9:00:30, 10:00:30, 11:00:30, 12:00:30, 15:00:30
h9-12s30	every day at 9:00:30, 9:01:30, 9:02:30 ... 12:58:30, 12:59:30
h9m/30;h10 (<i>API-specific syntax</i>)	every day at 9:00, 9:30, 10:00
h9m/30	every day at 9:00, 9:30, 10:00
h10 (<i>add this as another row in frontend</i>)	

Aligning time zones for proxies and agent

Note that Zabbix proxies and agent use their local time zones when processing scheduling intervals.

For this reason, when scheduling intervals are applied to items monitored by Zabbix proxy or agent active items, it is recommended to set the time zone of the respective proxies or agent the same as Zabbix server, otherwise the **queue** may report item delays incorrectly.

The time zone for Zabbix proxy or agent can be set using the environment variable TZ in the systemd unit file:

```
[Service]
...
Environment="TZ=Europe/Amsterdam"
```

2 Item value preprocessing

Overview

Preprocessing allows you to apply transformations to the received item values before saving them to the database. These transformations/preprocessing steps are performed by Zabbix server or proxy (if items are monitored by proxy).

This feature supports a variety of use cases, such as:

- converting bytes to bits (e.g., multiplying network traffic values by "8");
- calculating per-second statistics for incrementally increasing values;
- applying regular expressions to extract or modify values;
- executing custom scripts on values;
- discarding unchanged values to optimize database storage.

One or more preprocessing steps can be configured for an item. These steps are executed in the order they are configured.

Attention:

If a preprocessing step fails, an item becomes **unsupported**. This can be avoided by *Custom on fail* error-handling (available for most transformations), allowing you to discard values or set custom values.
For log items, log metadata (without value) will always reset the item unsupported state, making it supported again. This happens even if the initial error occurred after receiving a log value from agent.

All values passed to preprocessing are initially treated as strings. Conversion to the desired value type (as defined in item configuration) is performed at the end of the preprocessing pipeline. However, specific preprocessing steps may trigger earlier conversions, if required. For detailed technical information, see [Preprocessing details](#).

To ensure that your preprocessing configuration works as expected, you can **test it**.

See also: [Preprocessing examples](#)

Configuration

Preprocessing steps are defined in the **Preprocessing** tab of the item **configuration** form.

Preprocessing steps	Name	Parameters	Custom on fail	Actions
1:	Change per second		<input type="checkbox"/>	Test Remove
2:	Custom multiplier	8	<input type="checkbox"/>	Test Remove
Add				
Type of information	Numeric (unsigned)			
Add Test Cancel				

Click on *Add* to select a supported transformation.

The *Type of information* field is displayed at the bottom of the tab when at least one preprocessing step is defined. If required, it is possible to change the type of information without leaving the *Preprocessing* tab. See [Creating an item](#) for the detailed parameter description.

Supported transformations

All supported transformations are listed below. Click on the transformation name to see full details about it.

Name	Description	Type
Regular expression Replace	Match the value to the regular expression and replace with the required output. Find the search string and replace it with another (or nothing).	Text
Trim	Remove specified characters from the beginning and end of the value.	
Right trim	Remove specified characters from the end of the value.	
Left trim	Remove specified characters from the beginning of the value.	
XML XPath	Extract value or fragment from XML data using XPath functionality.	Structured data
JSON Path	Extract value or fragment from JSON data using JSONPath functionality .	
CSV to JSON	Convert CSV file data into JSON format.	
XML to JSON	Convert data in XML format to JSON.	
SNMP walk value	Extract value by the specified OID/MIB name and apply formatting options.	SNMP
SNMP walk to JSON	Convert SNMP values to JSON.	
SNMP get value	Apply formatting options to the SNMP get value.	
Custom multiplier	Multiply the value by the specified integer or floating-point value.	Arithmetic
Simple change	Calculate the difference between the current and previous value.	Change
Change per second	Calculate the value change (difference between the current and previous value) speed per second.	
Boolean to decimal	Convert the value from boolean format to decimal.	Numeral systems
Octal to decimal	Convert the value from octal format to decimal.	
Hexadecimal to decimal	Convert the value from hexadecimal format to decimal.	
JavaScript	Enter JavaScript code.	Custom scripts
In range	Define a range that a value should be in.	Validation
Matches regular expression	Specify a regular expression that a value must match.	
Does not match regular expression	Specify a regular expression that a value must not match.	
Check for error in JSON	Check for an application-level error message located at JSONPath.	
Check for error in XML	Check for an application-level error message located at XPath.	
Check for error using a regular expression	Check for an application-level error message using a regular expression.	
Check for not supported value	Check if no item value could be retrieved.	
Discard unchanged	Discard a value if it has not changed.	Throttling
Discard unchanged with heartbeat	Discard a value if it has not changed within the defined time period.	
Prometheus pattern	Use the following query to extract the required data from Prometheus metrics.	Prometheus
Prometheus to JSON	Convert the required Prometheus metrics to JSON.	

Note that for *Change* and *Throttling* preprocessing steps, Zabbix has to remember the last value to calculate/compare the new value as required. These previous values are handled by the preprocessing manager. If Zabbix server or proxy is restarted or there is any change made to preprocessing steps, the last value of the corresponding item is reset, resulting in:

- for *Simple change*, *Change per second* steps - the next value will be ignored because there is no previous value to calculate the change from;
- for *Discard unchanged*, *Discard unchanged with heartbeat* steps - the next value will never be discarded, even if it should have been because of discarding rules.

Regular expression

Match the value to the regular expression and replace with the required output.

Parameters:

- **pattern** - the regular expression;

- **output** - the output formatting template. An \N (where N=1...9) escape sequence is replaced with the Nth matched group. A \0 escape sequence is replaced with the matched text.

Comments:

- A failure to match the input value will make the item unsupported;

- The regular expression supports extraction of maximum 10 captured groups with the \N sequence;

- If you mark the *Custom on fail* checkbox, it is possible to specify custom error-handling options: either to discard the value, set a specified value, or set a specified error message. In case of a failed preprocessing step, the item will not become unsupported if the option to discard the value or set a specified value is selected.

- Please refer to [regular expressions](#) section for some existing examples.

Replace

Find the search string and replace it with another (or nothing).

Parameters:

- **search string** - the string to find and replace, case-sensitive (required);

- **replacement** - the string to replace the search string with. The replacement string may also be empty effectively allowing to delete the search string when found.

Comments:

- All occurrences of the search string will be replaced;
- It is possible to use escape sequences to search for or replace line breaks, carriage return, tabs and spaces "\n \r \t \s"; backslash can be escaped as "\\\" and escape sequences can be escaped as "\\n";
- Escaping of line breaks, carriage return, tabs is automatically done during low-level discovery.

Trim

Remove specified characters from the beginning and end of the value.

Right trim

Remove specified characters from the end of the value.

Left trim

Remove specified characters from the beginning of the value.

XML XPath

Extract value or fragment from XML data using XPath functionality.

Comments:

- For this option to work, Zabbix server (or Zabbix proxy) must be compiled with libxml support;

- Namespaces are not supported;

- If you mark the *Custom on fail* checkbox, it is possible to specify custom error-handling options: either to discard the value, set a specified value, or set a specified error message. In case of a failed preprocessing step, the item will not become unsupported if the option to discard the value or set a specified value is selected.

Examples:

```
number(/document/item/value) #will extract '10' from <document><item><value>10</value></item></document>
number(/document/item/@attribute) #will extract '10' from <document><item attribute="10"></item></document>
/document/item #will extract '<item><value>10</value></item>' from <document><item><value>10</value></item>
```

JSON Path

Extract value or fragment from JSON data using [JSONPath functionality](#).

If you mark the *Custom on fail* checkbox, it is possible to specify custom error-handling options: either to discard the value, set a specified value, or set a specified error message. In case of a failed preprocessing step, the item will not become unsupported if the option to discard the value or set a specified value is selected.

CSV to JSON

Convert CSV file data into JSON format.

For more information, see: [CSV to JSON preprocessing](#).

XML to JSON

Convert data in XML format to JSON.

For more information, see: [Serialization rules](#).

If you mark the *Custom on fail* checkbox, it is possible to specify custom error-handling options: either to discard the value, set a specified value, or set a specified error message. In case of a failed preprocessing step, the item will not become unsupported if the option to discard the value or set a specified value is selected.

SNMP walk value

Extract value by the specified OID/MIB name and apply formatting options:

- **Unchanged** - return hex-string as unescaped hex string;

- **UTF-8 from hex-STRING** - convert hex-string to UTF-8 string;

- **MAC from hex-STRING** - validate hex-string as MAC address and return a proper MAC address string (where ' ' are replaced by ': ');

- **Integer from BITS** - convert the first 8 bytes of a bit string expressed as a sequence of hex characters (e.g., "1A 2B 3C 4D") into a 64-bit unsigned integer. In bit strings longer than 8 bytes, consequent bytes will be ignored.

If you mark the *Custom on fail* checkbox, it is possible to specify custom error-handling options: either to discard the value, set a specified value, or set a specified error message. In case of a failed preprocessing step, the item will not become unsupported if the option to discard the value or set a specified value is selected.

SNMP walk to JSON

Convert SNMP values to JSON.

Specify a field name in the JSON and the corresponding SNMP OID path. Field values will be populated by values in the specified SNMP OID path.

Comments:

- Similar value formatting options as in the *SNMP walk value* step are available;

- You may use this preprocessing step for [SNMP OID discovery](#);

- If you mark the *Custom on fail* checkbox, it is possible to specify custom error-handling options: either to discard the value, set a specified value, or set a specified error message. In case of a failed preprocessing step, the item will not become unsupported if the option to discard the value or set a specified value is selected.

SNMP get value

Apply formatting options to the SNMP get value:

- **UTF-8 from Hex-STRING** - convert hex-string to UTF-8 string;

- **MAC from Hex-STRING** - validate hex-string as MAC address and return a proper MAC address string (where ' ' are replaced by ': ');

- **Integer from BITS** - convert the first 8 bytes of a bit string expressed as a sequence of hex characters (e.g., "1A 2B 3C 4D") into a 64-bit unsigned integer. In bit strings longer than 8 bytes, consequent bytes will be ignored.

If you mark the *Custom on fail* checkbox, it is possible to specify custom error-handling options: either to discard the value, set a specified value, or set a specified error message. In case of a failed preprocessing step, the item will not become unsupported if the option to discard the value or set a specified value is selected.

Custom multiplier

Multiply the value by the specified integer or floating-point value.

Comments:

- Use this option to convert values received in KB, MBps, etc., into B, Bps. Otherwise, Zabbix cannot correctly set [prefixes](#) (K, M, G, etc.).

- Note that if the item type of information is *Numeric (unsigned)*, incoming values with a fractional part will be trimmed (i.e., '0.9' will become '0') before the custom multiplier is applied;

- If you use a custom multiplier or store value as *Change per second* for items with the type of information set to *Numeric (unsigned)* and the resulting calculated value is actually a float number, the calculated value is still accepted as a correct one by trimming the decimal part and storing the value as an integer;

- Supported: scientific notation, for example, 1e+70; user macros and LLD macros; strings that include macros, for example, {#MACRO}e+10, {\$MACRO1}e+{\$MACRO2}. The macros must resolve to an integer or a floating-point number.
- If you mark the *Custom on fail* checkbox, it is possible to specify custom error-handling options: either to discard the value, set a specified value, or set a specified error message. In case of a failed preprocessing step, the item will not become unsupported if the option to discard the value or set a specified value is selected.

Simple change

Calculate the difference between the current and previous value.

Comments:

- This step can be useful to measure a constantly growing value;

- Evaluated as **value-*prev_value***, where *value* - the current value; *prev_value* - the previously received value;

- Only one change operation per item ("Simple change" or "Change per second") is allowed;
- If the current value is smaller than the previous value, Zabbix discards that difference (stores nothing) and waits for another value;

- If you mark the *Custom on fail* checkbox, it is possible to specify custom error-handling options: either to discard the value, set a specified value, or set a specified error message. In case of a failed preprocessing step, the item will not become unsupported if the option to discard the value or set a specified value is selected.

Change per second

Calculate the value change (difference between the current and previous value) speed per second.

Comments:

- This step is useful for calculating the speed per second of a constantly growing value;

- As this calculation may produce floating-point numbers, it is recommended to set the 'Type of information' to *Numeric (float)*, even if the incoming raw values are integers. This is especially relevant for small numbers where the decimal part matters. If the floating-point values are large and may exceed the 'float' field length in which case the entire value may be lost, it is actually suggested to use *Numeric (unsigned)* and thus trim only the decimal part.

- Evaluated as **(value-*prev_value*)/(time-*prev_time*)**, where *value* - the current value; *prev_value* - the previously received value; *time* - the current timestamp; *prev_time* - the timestamp of the previous value;

- Only one change operation per item ("Simple change" or "Change per second") is allowed;
- If the current value is smaller than the previous value, Zabbix discards that difference (stores nothing) and waits for another value. This helps to work correctly with, for instance, a wrapping (overflow) of 32-bit SNMP counters.

- If you mark the *Custom on fail* checkbox, it is possible to specify custom error-handling options: either to discard the value, set a specified value, or set a specified error message. In case of a failed preprocessing step, the item will not become unsupported if the option to discard the value or set a specified value is selected.

Boolean to decimal

Convert the value from boolean format to decimal.

Comments:

- The textual representation is translated into either 0 or 1. Thus, 'TRUE' is stored as 1 and 'FALSE' is stored as 0. All values are matched in a case-insensitive way. Currently recognized values are, for *TRUE* - true, t, yes, y, on, up, running, enabled, available, ok, master; for *FALSE* - false, f, no, n, off, down, unused, disabled, unavailable, err, slave. Additionally, any non-zero numeric value is considered to be TRUE and zero is considered to be FALSE.

- If you mark the *Custom on fail* checkbox, it is possible to specify custom error-handling options: either to discard the value, set a specified value, or set a specified error message. In case of a failed preprocessing step, the item will not become unsupported if the option to discard the value or set a specified value is selected.

Octal to decimal

Convert the value from octal format to decimal.

If you mark the *Custom on fail* checkbox, it is possible to specify custom error-handling options: either to discard the value, set a specified value, or set a specified error message. In case of a failed preprocessing step, the item will not become unsupported if the option to discard the value or set a specified value is selected.

Hexadecimal to decimal

Convert the value from hexadecimal format to decimal.

If you mark the *Custom on fail* checkbox, it is possible to specify custom error-handling options: either to discard the value, set a specified value, or set a specified error message. In case of a failed preprocessing step, the item will not become unsupported if the option to discard the value or set a specified value is selected.

JavaScript

Enter JavaScript code in the modal editor that opens when clicking in the parameter field or on the pencil icon next to it.

Comments:

- The available JavaScript length depends on the **database used**;

- For more information, see: [Javascript preprocessing](#).

In range

Define a range that a value should be in by specifying minimum/maximum values (inclusive).

Comments:

- Numeric values are accepted (including any number of digits, optional decimal part and optional exponential part, negative values);

- The minimum value should be less than the maximum;

- At least one value must exist;

- User macros and low-level discovery macros can be used;

- If you mark the *Custom on fail* checkbox, it is possible to specify custom error-handling options: either to discard the value, set a specified value, or set a specified error message. In case of a failed preprocessing step, the item will not become unsupported if the option to discard the value or set a specified value is selected.

Matches regular expression

Specify a regular expression that a value must match.

If you mark the *Custom on fail* checkbox, it is possible to specify custom error-handling options: either to discard the value, set a specified value, or set a specified error message. In case of a failed preprocessing step, the item will not become unsupported if the option to discard the value or set a specified value is selected.

Does not match regular expression

Specify a regular expression that a value must not match.

If you mark the *Custom on fail* checkbox, it is possible to specify custom error-handling options: either to discard the value, set a specified value, or set a specified error message. In case of a failed preprocessing step, the item will not become unsupported if the option to discard the value or set a specified value is selected.

Check for error in JSON

Check for an application-level error message located at JSONPath. Stop processing if succeeded and the message is not empty; otherwise, continue processing with the value that was before this preprocessing step.

Comments:

- These external service errors are reported to the user as is, without adding preprocessing step information;

- No error will be reported in case of failing to parse invalid JSON;

- If you mark the *Custom on fail* checkbox, it is possible to specify custom error-handling options: either to discard the value, set a specified value, or set a specified error message. In case of a failed preprocessing step, the item will not become unsupported if the option to discard the value or set a specified value is selected.

Check for error in XML

Check for an application-level error message located at XPath. Stop processing if succeeded and the message is not empty; otherwise, continue processing with the value that was before this preprocessing step.

Comments:

- These external service errors are reported to the user as is, without adding preprocessing step information;

- No error will be reported in case of failing to parse invalid XML;

- If you mark the *Custom on fail* checkbox, it is possible to specify custom error-handling options: either to discard the value, set a specified value, or set a specified error message. In case of a failed preprocessing step, the item will not become unsupported if the option to discard the value or set a specified value is selected.

Check for error using a regular expression

Check for an application-level error message using a regular expression. Stop processing if succeeded and the message is not empty; otherwise, continue processing with the value that was before this preprocessing step.

Parameters:

- **pattern** - the regular expression;

- **output** - the output formatting template. An \N (where N=1...9) escape sequence is replaced with the Nth matched group. A \0 escape sequence is replaced with the matched text.

Comments:

- These external service errors are reported to the user as is, without adding preprocessing step information;

- If you mark the *Custom on fail* checkbox, it is possible to specify custom error-handling options: either to discard the value, set a specified value, or set a specified error message. In case of a failed preprocessing step, the item will not become unsupported if the option to discard the value or set a specified value is selected.

Check for not supported value

Check if no item value could be retrieved. Specify how the failure should be processed, based on inspecting the returned error message.

Parameters:

- **scope** - select the error processing scope: `
any error` - any error; `
error matches` - only the error that matches the regular expression specified in `pattern`; `
error does not match` - only the error that does not match the regular expression specified in `pattern` `
`
- **pattern** - the regular expression to match the error to. If `any error` is selected in the scope parameter, this field is not displayed. If displayed, this field is mandatory. `
`

Comments:

- Normally, the absence/failure to retrieve a value would lead to the item becoming unsupported. This preprocessing step allows you to modify this behavior. If you mark the *Custom on fail* checkbox (always marked and grayed out for this preprocessing step), it is possible to specify custom error-handling options: either to discard the value, set a specified value, or set a specified error message. In case of a failed preprocessing step, the item will not become unsupported if the option to discard the value or set a specified value is selected.
- This preprocessing step only checks if no item value could be retrieved. It does not check, for example, if the type of the retrieved value (e.g., string) matches the item's type of information (e.g., numeric). If there is a type mismatch, the item may still become unsupported after all preprocessing steps are executed. To check for a type mismatch, you may use, for example, the *Custom multiplier* preprocessing step; see [Preprocessing examples](#).
- Capturing regular expression groups is supported in the *Set value to* or *Set error to* fields. Use `\N` (where `N=1...9`) to retrieve the Nth matched group; use `\0` to retrieve the matched text;
- These steps are always executed as the first preprocessing steps and are placed above all others after saving changes to the item;
- Multiple *Check for not supported value* steps are supported, in the specified order. A step for `any error` will be automatically placed as the last step in this group.

Discard unchanged

Discard a value if it has not changed.

Comments:

- If a value is discarded, it is not saved in the database and Zabbix server has no knowledge that this value was received. No trigger expressions will be evaluated, as a result, no problems for related triggers will be created/resolved. Functions will work only based on data that is actually saved in the database. As trends are built based on data in the database, if there is no value saved for an hour then there will also be no trends data for that hour. `
`
- Only one throttling option can be specified per item.

Discard unchanged with heartbeat

Discard a value if it has not changed within the defined time period (in seconds).

Comments:

- Positive integer values are supported to specify the seconds (minimum - 1 second); `
`
- Time suffixes can be used (e.g., 30s, 1m, 2h, 1d); `
`
- User macros and low-level discovery macros can be used; `
`
- If a value is discarded, it is not saved in the database and Zabbix server has no knowledge that this value was received. No trigger expressions will be evaluated, as a result, no problems for related triggers will be created/resolved. Functions will work only based on data that is actually saved in the database. As trends are built based on data in the database, if there is no value saved for an hour then there will also be no trends data for that hour. `
`
- Only one throttling option can be specified per item.

Prometheus pattern

Use the following query to extract the required data from Prometheus metrics.

See [Prometheus checks](#) for more details.

Prometheus to JSON

Convert the required Prometheus metrics to JSON.

See [Prometheus checks](#) for more details.

Macro support

[User macros](#) and user macros with context are supported in:

- preprocessing step parameters, including JavaScript code;

- custom error-handling parameters (*Set value to* and *Set error to* fields).

Note:

The macro context is ignored when a macro is replaced with its value. The macro value is inserted in the code as is, it is not possible to add additional escaping before placing the value in the JavaScript code. Please be advised that this can cause JavaScript errors in some cases.

Testing

See [preprocessing testing](#).

1 Preprocessing testing

Testing

Testing preprocessing steps is useful to make sure that complex preprocessing pipelines yield the results that are expected from them, without waiting for the item value to be received and preprocessed.

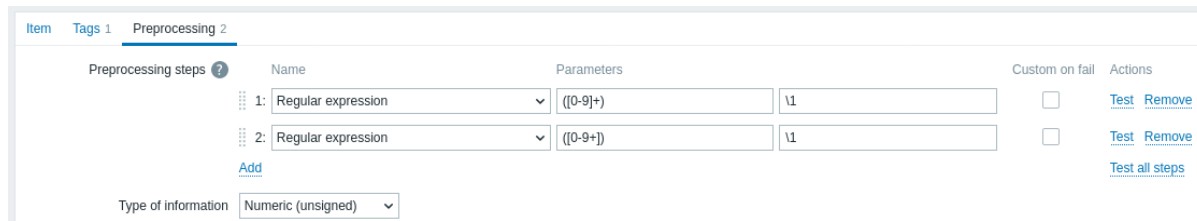



It is possible to test:

- against a hypothetical value
- against a real value from a host

Each preprocessing step can be tested individually as well as all steps can be tested together. When you click on the *Test* or *Test all steps* button respectively in the Actions block, a testing window is opened.

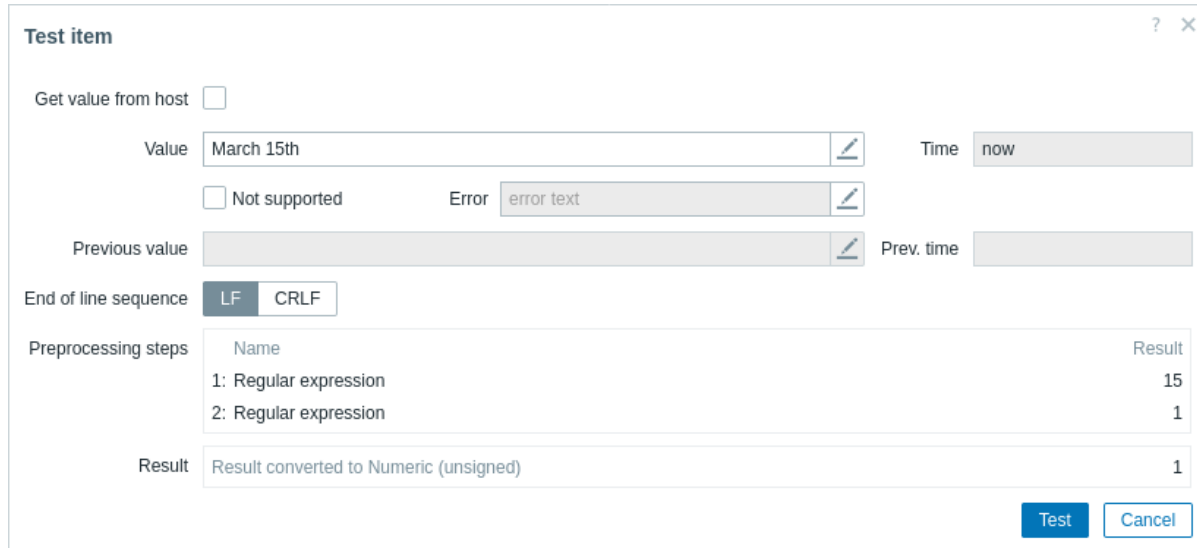
Testing hypothetical value



Parameter	Description
<i>Get value from host</i>	If you want to test a hypothetical value, leave this checkbox unmarked. See also: Testing real value .
<i>Value</i>	Enter the input value to test. Clicking in the parameter field or on the view/edit button  will open a text area window for entering the value or code block.
<i>Not supported</i>	Mark this checkbox to test an unsupported value. This option is useful to test the <i>Check for not supported value</i> preprocessing step.

Parameter	Description
<i>Error</i>	Enter the error text. This field is enabled when <i>Get value from host</i> is unchecked, but <i>Not supported</i> is checked. If <i>Get value from host</i> is checked, this field gets filled with the actual error message (read-only) from the host.
<i>Time</i>	Time of the input value is displayed: <code>now</code> (read-only).
<i>Previous value</i>	Enter a previous input value to compare to. Only for <i>Change</i> and <i>Throttling</i> preprocessing steps.
<i>Previous time</i>	Enter the previous input value time to compare to. Only for <i>Change</i> and <i>Throttling</i> preprocessing steps. The default value is based on the 'Update interval' field value of the item (if '1m', then this field is filled with <code>now-1m</code>). If nothing is specified or the user has no access to the host, the default is <code>now-30s</code> .
<i>Macros</i>	If any macros are used, they are listed along with their values. The values are editable for testing purposes, but the changes will only be saved within the testing context.
<i>End of line sequence</i>	Select the end of line sequence for multiline input values: LF - LF (line feed) sequence CRLF - CRLF (carriage-return line-feed) sequence.
<i>Preprocessing steps</i>	Preprocessing steps are listed; the testing result is displayed for each step after the <i>Test</i> button is clicked. Test results are truncated to a maximum size of 512KB when sent to the frontend. If a result is truncated, a warning icon is displayed. The warning description is displayed on mouseover. Note that data larger than 512KB is still processed fully by Zabbix server. If the step failed in testing, an error icon is displayed. The error description is displayed on mouseover. In case "Custom on fail" is specified for the step and that action is performed, a new line appears right after the preprocessing test step row, showing what action was done and what outcome it produced (error or value).
<i>Result</i>	The final result of testing preprocessing steps is displayed in all cases when all steps are tested together (when you click on the <i>Test all steps</i> button). The type of conversion to the value type of the item is also displayed, for example <code>Result converted to Numeric (unsigned)</code> . Test results are truncated to a maximum size of 512KB when sent to the frontend. If a result is truncated, a warning icon is displayed. The warning description is displayed on mouseover. Note that data larger than 512KB is still processed fully by Zabbix server.

Click on *Test* to see the result after each preprocessing step.

Test values are stored between test sessions for either individual steps or all steps, allowing the user to change preprocessing steps or item configuration and then return to the testing window without having to re-enter information. Values are lost on a page refresh though.

The testing is done by Zabbix server. The frontend sends a corresponding request to the server and waits for the result. The request contains the input value and preprocessing steps (with expanded user macros). For *Change* and *Throttling* steps, an optional previous value and time can be specified. The server responds with results for each preprocessing step.

All technical errors or input validation errors are displayed in the error box at the top of the testing window.

Testing real value

To test preprocessing against a real value:

- Mark the *Get value from host* checkbox
- Enter or verify host parameters (host address, port, proxy name/no proxy) and item-specific details (such as SNMPv2 community or SNMPv3 security credentials). These fields are context-aware:
 - The values are pre-filled when possible, i.e., for items requiring an agent, by taking the information from the selected agent interface of the host
 - The values have to be filled manually for template items
 - Plain-text macro values are resolved
 - Where the field value (or part of the value) is a secret or Vault macro, the field will be empty and has to be filled out manually. If any item parameter contains a secret macro value, the following warning message is displayed: "Item contains user-defined macros with secret values. Values of these macros should be entered manually."
 - The fields are disabled when not needed in the context of the item type (e.g., the host address and the proxy fields are disabled for calculated items)
- Click on *Get value and test* to test the preprocessing

Test item ? X

Get value from host

* Host address Port

Proxy

Value

Time

Not supported Error

Previous value Prev. time

End of line sequence LF CRLF

Preprocessing steps	Name	Result
	1: Discard unchanged with heartbeat	7.0.0alpha5

Result

If you have specified a value mapping in the item configuration form ('Show value' field), the item test dialog will show another line after the final result, named 'Result with value map applied'.

Parameters that are specific to getting a real value from a host:

Parameter	Description
<i>Get value from host</i>	Mark this checkbox to get a real value from the host.
<i>Host address</i>	Enter the host address.
<i>Port</i>	This field is automatically filled by the address of the item host interface. Enter the host port.
<i>Additional fields for SNMP interfaces
(SNMP version, SNMP community, Context name, etc.)</i>	This field is automatically filled by the port of item host interface. See Configuring SNMP monitoring for additional details on configuring an SNMP interface (v1, v2 and v3). These fields are automatically filled from the item host interface.
<i>Proxy</i>	Specify the proxy if the host is monitored by a proxy.
<i>Value</i>	This field is automatically filled by the proxy of the host (if any). Value retrieved from the host. Clicking in the parameter field or on the view/edit button <input type="button" value="⌵"/> will open a text area window of the value or code block. Values are truncated to a maximum size of 512KB and only in the frontend. If a result is truncated, a warning icon is displayed. The warning description is displayed on mouseover. Note that data larger than 512KB is still processed fully by Zabbix server.

For the rest of the parameters, see [Testing hypothetical value](#) above.

2 Preprocessing details

Overview

This section provides item value preprocessing details. The item value preprocessing allows to define and execute **transformation rules** for the received item values.

Preprocessing is managed by the preprocessing manager process along with preprocessing workers that perform the preprocessing steps. All values (with or without preprocessing) from different data gatherers pass through the preprocessing manager before being added to the history cache. Socket-based IPC communication is used between data gatherers (pollers, trappers, etc.) and the preprocessing process. Either Zabbix server or Zabbix proxy (for the items monitored by the proxy) performs the preprocessing steps.

Item value processing

To visualize the data flow from data source to the Zabbix database, we can use the following simplified diagram:

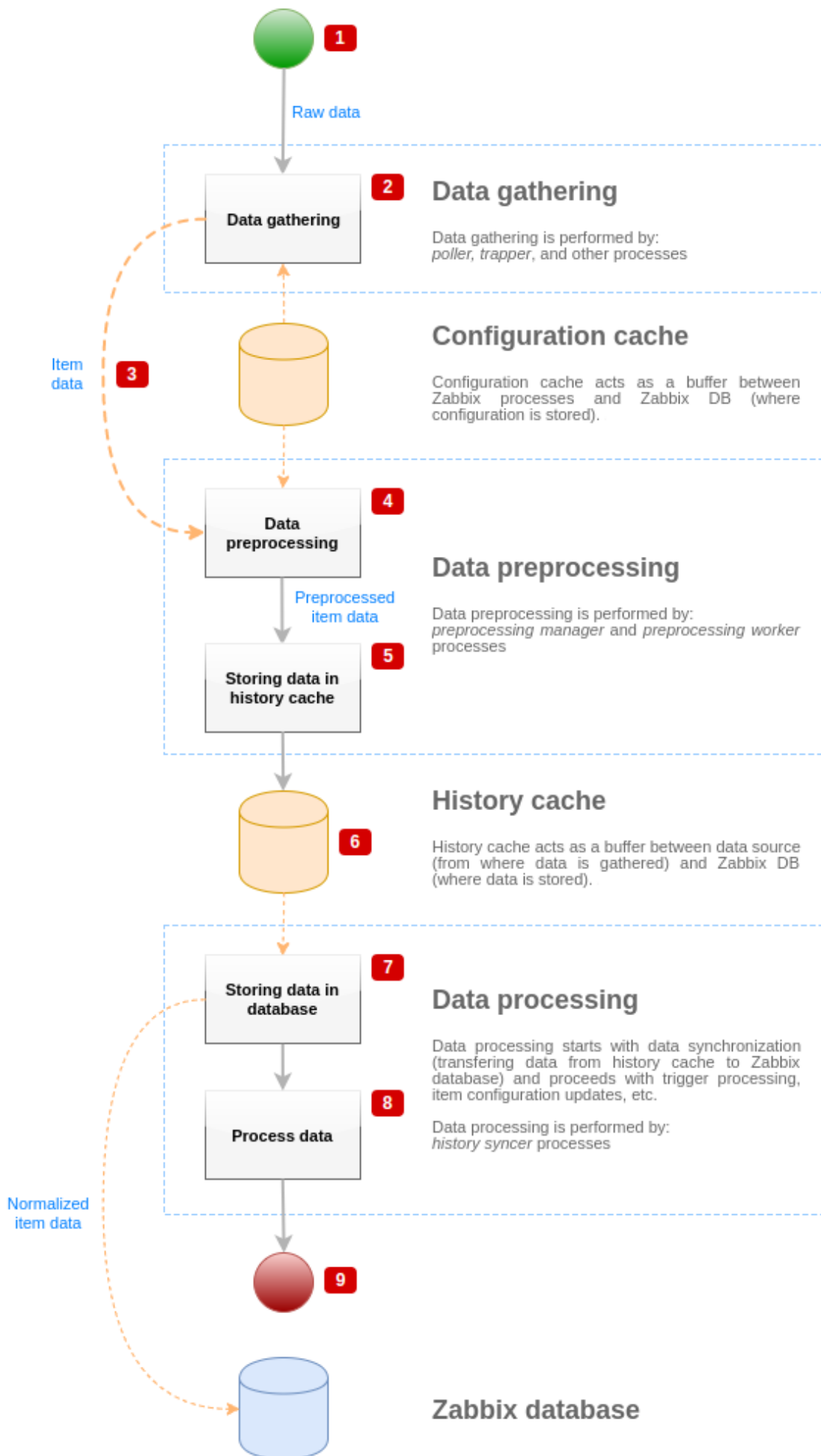

The diagram above shows only processes, objects and actions related to item value processing in a **simplified** form. The diagram does not show conditional direction changes, error handling or loops. The local data cache of the preprocessing manager is not shown either because it doesn't affect the data flow directly. The aim of this diagram is to show processes involved in the item value processing and the way they interact.

- Data gathering starts with raw data from a data source. At this point, the data contains only ID, timestamp and value (can be multiple values as well).
- No matter what type of data gatherer is used, the idea is the same for active or passive checks, for trapper items, etc., as it only changes the data format and the communication starter (either data gatherer is waiting for a connection and data, or data gatherer initiates the communication and requests the data). The raw data is validated, the item configuration is retrieved from the configuration cache (data is enriched with the configuration data).
- A socket-based IPC mechanism is used to pass data from data gatherers to the preprocessing manager. At this point the data gatherer continues to gather data without waiting for the response from preprocessing manager.
- Data preprocessing is performed. This includes the execution of preprocessing steps and dependent item processing.

Note:

An item can change its state to NOT SUPPORTED while preprocessing is performed if any of preprocessing steps fail.

- The history data from the local data cache of the preprocessing manager is being flushed into the history cache.
- At this point the data flow stops until the next synchronization of history cache (when the history syncer process performs data synchronization).
- The synchronization process starts with data normalization before storing data in Zabbix database. The data normalization performs conversions to the desired item type (type defined in item configuration), including truncation of textual data based on predefined sizes allowed for those types (HISTORY_STR_VALUE_LEN for string, HISTORY_TEXT_VALUE_LEN for text and HISTORY_LOG_VALUE_LEN for log values). The data is being sent to the Zabbix database after the normalization is done.

Note:

An item can change its state to NOT SUPPORTED if data normalization fails (for example, when a textual value cannot be converted to number).

- The gathered data is being processed - triggers are checked, the item configuration is updated if item becomes NOT SUPPORTED, etc.
- This is considered the end of data flow from the point of view of item value processing.

Item value preprocessing

Data preprocessing is performed in the following steps:

- The item value is passed to the preprocessing manager using a UNIX socket-based IPC mechanism.
- If the item has neither preprocessing nor dependent items, its value is either added to the history cache or sent to the LLD manager. Otherwise:
 - A preprocessing task is created and added to the queue and preprocessing workers are notified about the new task.
 - At this point the data flow stops until there is at least one unoccupied (i.e., not executing any tasks) preprocessing worker.
 - When a preprocessing worker is available, it takes the next task from the queue.
 - After the preprocessing is done (both failed and successful execution of preprocessing steps), the preprocessed value is added to the finished task queue and the manager is notified about a new finished task.
 - The preprocessing manager converts the result to desired format (defined by item value type) and either adds it to the history cache or sends to the LLD manager.
 - If there are dependent items for the processed item, then dependent items are added to the preprocessing queue with the preprocessed master item value. Dependent items are enqueued bypassing the normal value preprocessing requests, but only for master items with the value set and not in a NOT SUPPORTED state.

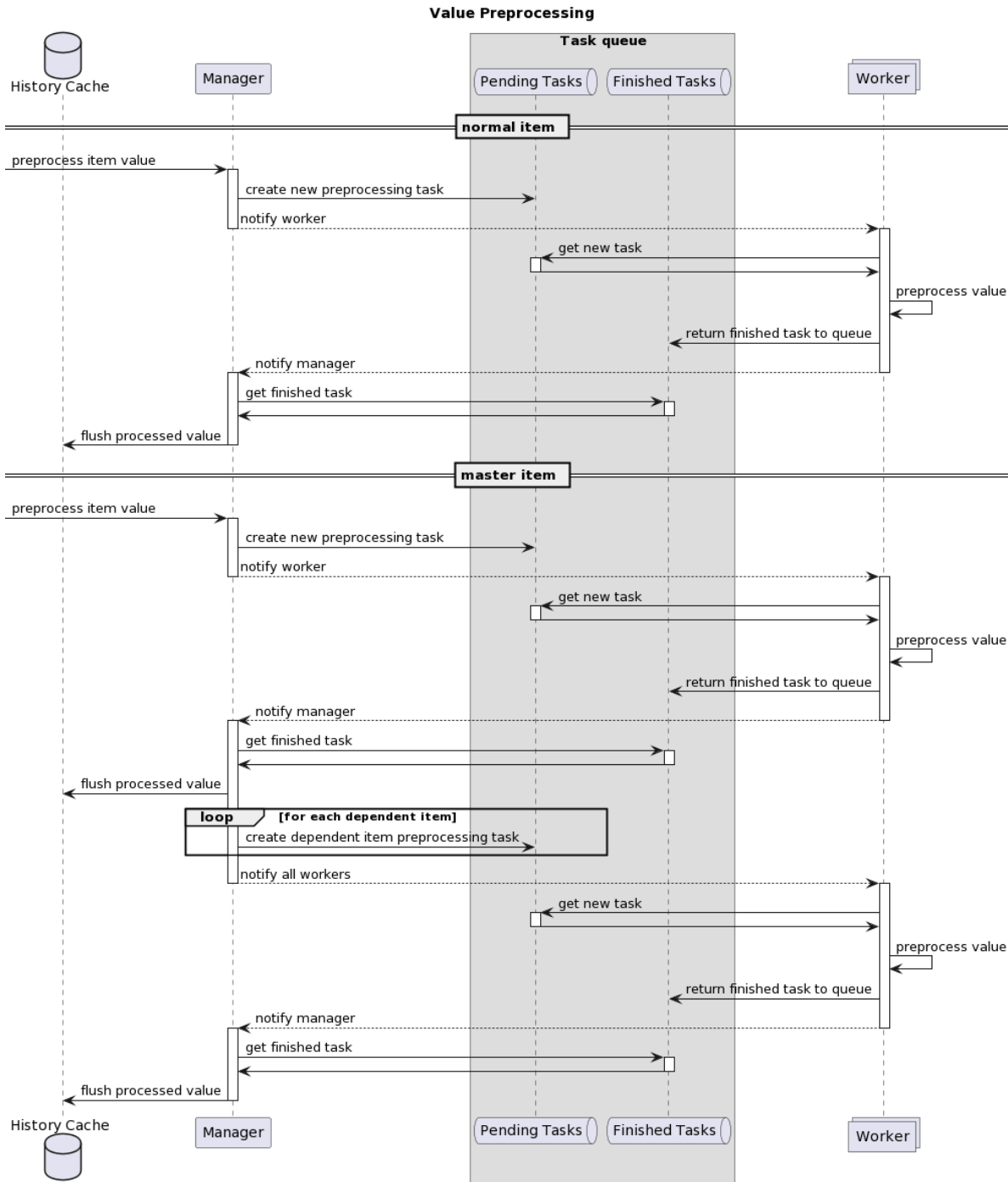

Note that in the diagram the master item preprocessing is slightly simplified by skipping the preprocessing caching.

Preprocessing queue

The preprocessing queue is organized as:

- the list of pending tasks:
 - tasks created directly from value preprocessing requests in the order they were received
- the list of immediate tasks (processed before pending tasks):
 - testing tasks (created in response to item/preprocessing testing requests by the frontend)
 - dependent item tasks
 - sequence tasks (tasks that must be executed in a strict order):
 - * having preprocessing steps using the last value:
 - change
 - throttling
 - JavaScript (bytecode caching)
 - * dependent item preprocessing caching
- the list of finished tasks

Preprocessing caching

Preprocessing caching was introduced to improve the preprocessing performance for multiple dependent items having similar preprocessing steps (which is a common LLD outcome).

Caching is done by preprocessing one dependent item and reusing some of the internal preprocessing data for the rest of the dependent items. The preprocessing cache is supported only for the first preprocessing step of the following types:

- Prometheus pattern (indexes input by metrics)
- JSONPath (parses the data into object tree and indexes the first expression `[?(@.path == "value")]`)

Preprocessing workers

The Zabbix server configuration file allows users to set the count of preprocessing worker threads. The `StartPreprocessors` configuration parameter should be used to set the number of pre-started instances of preprocessing workers, which should at least match the number of available CPU cores. If preprocessing tasks are not CPU-bound and involve frequent network requests, configuring additional workers is recommended. The optimal number of preprocessing workers can be determined by many factors, including the count of "preprocessable" items (items that require to execute any preprocessing steps), the count of data gathering processes, the average step count for item preprocessing, etc.

But assuming that there are no heavy preprocessing operations like parsing large XML/JSON chunks, the number of preprocessing workers can match the total number of data gatherers. This way, there will mostly (except for the cases when data from the gatherer comes in bulk) be at least one unoccupied preprocessing worker for collected data.

Warning:

Too many data gathering processes (pollers, unreachable pollers, ODBC pollers, HTTP pollers, Java pollers, pingers, trappers, proxypollers) together with IPMI manager, SNMP trapper and preprocessing workers can exhaust the per-process file descriptor limit for the preprocessing manager. Exhausting the per-process file descriptor limit will cause Zabbix server to stop, typically shortly after startup but sometimes taking longer. To avoid such issues, review the [Zabbix server configuration file](#) to optimize the number of concurrent checks and processes. Additionally, if necessary, ensure that the file descriptor limit is set sufficiently high by checking and adjusting system limits.

Value processing pipeline

Item value processing is executed in multiple steps (or phases) by multiple processes. This can cause:

- A dependent item can receive values, while THE master value cannot. This can be achieved by using the following use case:
 - Master item has value type UINT (trapper item can be used), dependent item has value type TEXT.
 - No preprocessing steps are required for both master and dependent items.
 - Textual value (for example, "abc") should be passed to master item.
 - As there are no preprocessing steps to execute, preprocessing manager checks if master item is not in NOT SUPPORTED state and if value is set (both are true) and enqueues dependent item with the same value as master item (as there are no preprocessing steps).
 - When both master and dependent items reach history synchronization phase, master item becomes NOT SUPPORTED because of the value conversion error (textual data cannot be converted to unsigned integer).

As a result, the dependent item receives a value, while the master item changes its state to NOT SUPPORTED.

- A dependent item receives value that is not present in the master item history. The use case is very similar to the previous one, except for the master item type. For example, if CHAR type is used for master item, then master item value will be truncated at the history synchronization phase, while dependent items will receive their values from the initial (not truncated) value of the master item.

3 Preprocessing examples

Overview

This section presents examples of using preprocessing steps to accomplish some practical tasks.

Filtering VMware event log records

This example uses the `Matches regular expression` preprocessing step to filter unnecessary events from the VMware event log.

1. On a working VMware Hypervisor host, check that the event log item `vmware.eventlog` is present and working properly. Note that the event log item could already be present on the hypervisor if a `VMware` template has been linked during the host creation.
2. On the VMware Hypervisor host, create a `dependent item` of "Log" type and set the event log item as its master.
3. In the `Preprocessing` tab of the dependent item, select the "Matches regular expression" preprocessing step and specify, for example, one of the following parameters:

Filters all log events:

```
pattern: .* logged in .*
```

Filters lines containing usernames after "User":

```
pattern: \bUser\s+\K\S+
```

Attention:

If the regular expression is not matched, then the dependent item becomes unsupported with a corresponding error message. To avoid this, mark the "Custom on fail" checkbox and select an option such as discarding the value or setting a custom one.

Alternatively, you may use the **Regular expression** preprocessing step to extract matching groups and control output. For example:

Extracts and outputs the entire log event containing "logged in":

```
pattern: .*logged in.*
```

```
output: \0
```

Extracts and outputs usernames following "User":

```
pattern: User (.*?)(?=\ )
```

```
output: \1
```

Checking retrieved value type

This example uses the **Custom multiplier** preprocessing step to check if the retrieved item value type is numeric.

In the *Preprocessing* tab of an item, select the "Custom multiplier" preprocessing step and set the following parameter:

Multiplies the retrieved value by 1:

```
number: 1
```

Attention:

If preprocessing fails (e.g., input is not numeric), then the item becomes unsupported with a corresponding error message. To avoid this, mark the "Custom on fail" checkbox and select an option such as discarding the value or setting a custom one.

4 JSONPath functionality

Overview

This section outlines the supported JSONPath functionality within item value preprocessing steps.

JSONPath is composed of segments separated by dots. A segment can take the form of a simple word, representing a JSON value name, the wildcard character (*), or a more intricate construct enclosed within square brackets. The dot before a bracketed segment is optional and can be omitted.

JSONPath example	Description
\$.object.name	Return object.name contents.
\$.object['name']	Return object.name contents.
\$.object.['name']	Return object.name contents.
\$["object"]['name']	Return object.name contents.
\$.['object'].["name"]	Return object.name contents.
\$.object.history.length()	Return the number of object.history array elements.
\$[?(@.name == 'Object')].price.first()	Return the value of the price property from the first object named "Object".
\$[?(@.name == 'Object')].history.first().length()	Return the number of history array elements from the first object named "Object".
\$[?(@.price > 10)].length()	Return the number of objects with a price greater than 10.

See also: [Escaping special characters from LLD macro values in JSONPath.](#)

Supported segments

Segment	Description
<name>	Match object property by name.
*	Match all object properties.
['<name>']	Match object property by name.
['<name>', '<name>', ...]	Match object property by any of the listed names.
<index>	Match array element by index.
<number>, <number>, ...]	Match array element by any of the listed indexes.
[*]	Match all object properties or array elements.
[<start>:<end>]	Match array elements by the defined range: <start> - the first index to match (including); if not specified, matches all array elements from the beginning; if negative, specifies starting offset from the end of array; <end> - the last index to match (excluding); if not specified, matches all array elements to the end; if negative, specifies starting offset from the end of array.
[?(<expression>)]	Match objects/array elements by applying a filter expression.

To find a matching segment ignoring its ancestry (detached segment), it must be prefixed with two dots (. .). For example, \$. . name or \$. . ['name'] return values of all name properties.

Matched element names can be extracted by adding a tilde (~) suffix to the JSONPath. It returns the name of the matched object or an index in string format of the matched array item. The output format follows the same rules as other JSONPath queries - definite path results are returned 'as is', and indefinite path results are returned in an array. However, there is minimal value in extracting the name of an element that matches a definitive path, as it is already known.

Filter expression

The filter expression is an arithmetical expression in infix notation.

Supported operands:

Operand	Description
"<text>"	Text constant.
'<text>'	Example: 'value: \\ '1\\ '' "value: '1'"
<number>	Numeric constant supporting scientific notation.
<jsonpath starting with \$>	Example: 123 Value referred to by the JSONPath from the input document root node; only definite paths are supported.
<jsonpath starting with @>	Example: \$.object.name Value referred to by the JSONPath from the current object/element; only definite paths are supported.
	Example: @.name

Supported operators:

Operator	Type	Description	Result
-	Binary	Subtraction	Number
+	Binary	Addition	Number
/	Binary	Division	Number
*	Binary	Multiplication	Number
==	Binary	Equality	Boolean (1/0)
!=	Binary	Inequality	Boolean (1/0)
<=	Binary	Less than	Boolean (1/0)
<=	Binary	Less than or equal to	Boolean (1/0)
>	Binary	Greater than	Boolean (1/0)

Operator	Type	Description	Result
>=	Binary	Greater than or equal to	Boolean (1/0)
=~	Binary	Matches regular expression	Boolean (1/0)
!	Unary	Boolean NOT	Boolean (1/0)
	Binary	Boolean OR	Boolean (1/0)
&&	Binary	Boolean AND	Boolean (1/0)

Functions

Functions can be used at the end of JSONPath. Multiple functions can be chained if the preceding function returns value that is accepted by the following function.

Supported functions:

Function	Description	Input	Output
avg	Average value of numbers in an input array	Array of numbers	Number
min	Minimum value of numbers in an input array	Array of numbers	Number
max	Maximum value of numbers in an input array	Array of numbers	Number
sum	Sum of numbers in an input array	Array of numbers	Number
length	Number of elements in an input array	Array	Number
first	The first element of an array	Array	A JSON construct (object, array, value) depending on the contents of the input array

JSONPath aggregate functions accept quoted numeric values. These values are automatically converted from strings to numeric types when aggregation is needed. Incompatible input will cause the function to generate an error.

Output value

JSONPaths can be divided into definite and indefinite paths. A definite path can return only null or a single match. An indefinite path can return multiple matches: JSONPaths with detached, multiple name/index lists, array slices, or expression segments. However, when a function is used, the JSONPath becomes definite, as functions always output a single value.

A definite path returns the object/array/value it is referencing. In contrast, an indefinite path returns an array of the matched objects/arrays/values.

Attention:

The property order in JSONPath query results may not align with the original JSON property order due to internal optimization methods. For example, the JSONPath `$.books[1]["author", "title"]` may return `["title", "author"]`. If preserving the original property order is essential, alternative post-query processing methods should be considered.

Path formatting rules

Whitespaces (space, tab character) can be used in bracket notation segments and expressions, for example: `$('a') [0] [?($.b == 'c')] [: -1].first()`.

Strings should be enclosed with single (') or double (") quotes. Inside the strings, single or double quotes (depending on which are used to enclose it) and backslashes (\) are escaped with the backslash (\) character.

Example

```
{
  "books": [
    {
      "category": "reference",
      "author": "Nigel Rees",
      "title": "Sayings of the Century",
      "price": 8.95,
      "id": 1
    },
    {
      "category": "fiction",
      "author": "Evelyn Waugh",
      "title": "Sword of Honour",
```

```

    "price": 12.99,
    "id": 2
  },
  {
    "category": "fiction",
    "author": "Herman Melville",
    "title": "Moby Dick",
    "isbn": "0-553-21311-3",
    "price": 8.99,
    "id": 3
  },
  {
    "category": "fiction",
    "author": "J. R. R. Tolkien",
    "title": "The Lord of the Rings",
    "isbn": "0-395-19395-8",
    "price": 22.99,
    "id": 4
  }
],
"services": {
  "delivery": {
    "servicegroup": 1000,
    "description": "Next day delivery in local town",
    "active": true,
    "price": 5
  },
  "bookbinding": {
    "servicegroup": 1001,
    "description": "Printing and assembling book in A5 format",
    "active": true,
    "price": 154.99
  },
  "restoration": {
    "servicegroup": 1002,
    "description": "Various restoration methods",
    "active": false,
    "methods": [
      {
        "description": "Chemical cleaning",
        "price": 46
      },
      {
        "description": "Pressing pages damaged by moisture",
        "price": 24.5
      },
      {
        "description": "Rebinding torn book",
        "price": 99.49
      }
    ]
  }
}
],
"filters": {
  "price": 10,
  "category": "fiction",
  "no filters": "no \"filters\""
},
"closed message": "Store is closed",
"tags": [
  "a",
  "b",

```

```

    "c",
    "d",
    "e"
  ]
}

```

JSONPath	Type	Result
\$.filters.price	definite	10
\$.filters.category	definite	fiction
\$.filters['no filters']	definite	no "filters"
\$.filters	definite	{ "price": 10, "category": "fiction", "no filters": "no \"filters\"" }
\$.books[1].title	definite	Sword of Honour
\$.books[-1].author	definite	J. R. R. Tolkien
\$.books.length()	definite	4
\$.tags[:]	indefinite	["a", "b", "c", "d", "e"]
\$.tags[2:]	indefinite	["c", "d", "e"]
\$.tags[:3]	indefinite	["a", "b", "c"]
\$.tags[1:4]	indefinite	["b", "c", "d"]
\$.tags[-2:]	indefinite	["d", "e"]
\$.tags[: -3]	indefinite	["a", "b"]
\$.tags[: -3].length()	definite	2
\$.books[0, 2].title	indefinite	["Moby Dick", "Sayings of the Century"]
\$.books[1]['author', "title"]	indefinite	["Sword of Honour", "Evelyn Waugh"]
\$.id	indefinite	[1, 2, 3, 4]
\$.services..price	indefinite	[154.99, 5, 46, 24.5, 99.49]
\$.books[?(@.id == 4 - 0.4 * 5)].title	indefinite	["Sword of Honour"]
		Note: This query shows that arithmetical operations can be used in queries; it can be simplified to \$.books[?(@.id == 2)].title
\$.books[?(@.id == 2 \\ @.id == 4)].title	indefinite	["Sword of Honour", "The Lord of the Rings"]
\$.books[?(!(@.id == 2))].title	indefinite	["Sayings of the Century", "Moby Dick", "The Lord of the Rings"]
\$.books[?(@.id != 2)].title	indefinite	["Sayings of the Century", "Moby Dick", "The Lord of the Rings"]
\$.books[?(@.title =~ " of ")].title	indefinite	["Sayings of the Century", "Sword of Honour", "The Lord of the Rings"]
\$.books[?(@.price > 12.99)].title	indefinite	["The Lord of the Rings"]
\$.books[?(@.author > "Herman Melville")].title	indefinite	["Sayings of the Century", "The Lord of the Rings"]
\$.books[?(@.price > \$.filters.price)].title	indefinite	["Sword of Honour", "The Lord of the Rings"]
\$.books[?(@.category == \$.filters.category)].title	indefinite	["Sword of Honour", "Moby Dick", "The Lord of the Rings"]
\$.books[?(@.category == "fiction" && @.price < 10)].title	indefinite	["Moby Dick"]

JSONPath	Type	Result
<code>\$...[?(@.id)]</code>	indefinite	[{ "price": 8.95, "id": 1, "category": "reference", "author": "Nigel Rees", "title": "Sayings of the Century" }, { "price": 12.99, "id": 2, "category": "fiction", "author": "Evelyn Waugh", "title": "Sword of Honour" }, { "price": 8.99, "id": 3, "category": "fiction", "author": "Herman Melville", "title": "Moby Dick", "isbn": "0-553-21311-3" }, { "price": 22.99, "id": 4, "category": "fiction", "author": "J. R. R. Tolkien", "title": "The Lord of the Rings", "isbn": "0-395-19395-8" }]
<code>\$.services..[?(@.price > 50)].description</code>	indefinite	["Printing and assembling book in A5 format", "Rebinding torn book"]
<code>\$.id.length()</code>	definite	4
<code>\$.books[?(@.id == 2)].title.first()</code>	definite	Sword of Honour
<code>\$.tags.first().length()</code>	definite	5
		Note: <code>\$.tags</code> is an indefinite path, so it returns an array of matched elements, i.e., <code>[["a", "b", "c", "d", "e"]]</code> ; <code>first()</code> returns the first element, i.e., <code>["a", "b", "c", "d", "e"]</code> ; <code>length()</code> calculates the length of the element, i.e., 5.
<code>\$.books[*].price.min()</code>	definite	8.95
<code>\$.price.max()</code>	definite	154.99
<code>\$.books[?(@.category == "fiction")].price.avg()</code>	definite	14.99
<code>\$.books[?(@.category == \$.filters.xyz)].title</code>	indefinite	Note: A query without match returns NULL for definite and indefinite paths.
<code>\$.services[?(@.active=="true")].servicegroup</code>	indefinite	["1001", "1000"]
		Note: Text constants must be used in boolean value comparisons.
<code>\$.services[?(@.active=="false")].servicegroup</code>	indefinite	["1002"]
		Note: Text constants must be used in boolean value comparisons.
<code>\$.services[?(@.servicegroup=="1002")].description</code>	indefinite	["1002"]

1 Escaping special characters from LLD macro values in JSONPath

When low-level discovery macros are used in JSONPath preprocessing and their values are resolved, the following rules of escaping special characters are applied:

- only backslash (\) and double quote (") characters are considered for escaping;
- if the resolved macro value contains these characters, each of them is escaped with a backslash;
- if they are already escaped with a backslash, it is not considered as escaping and both the backslash and the following special characters are escaped once again.

For example:

JSONPath	LLD macro value	After substitution
\$.[?(@.value == "{#MACRO}")]	special "value"	\$.[?(@.value == "special \"value\"")]
	c:\temp	\$.[?(@.value == "c:\\temp")]
	a\\b	\$.[?(@.value == "a\\\\b")]

When used in the expression, the macro that may have special characters should be enclosed in double quotes:

JSONPath	LLD macro value	After substitution	Result
\$.[?(@.value == "{#MACRO}")]	special "value"	\$.[?(@.value == "special \"value\"")]	OK
\$.[?(@.value == {#MACRO})]		\$.[?(@.value == special \"value\"")]	Bad JSONPath expression

When used in the path, the macro that may have special characters should be enclosed in square brackets **and** double quotes:

JSONPath	LLD macro value	After substitution	Result
\$.["{#MACRO}"].value	c:\temp	\$.["c:\\temp"].value	OK
\$.{#MACRO}.value		\$.c:\\temp.value	Bad JSONPath expression

5 JavaScript preprocessing

Overview

This section provides details of preprocessing by JavaScript.

JavaScript preprocessing

JavaScript preprocessing is done by invoking JavaScript function with a single parameter 'value' and user-provided function body. The preprocessing step result is the value returned by this function, for example, to perform Fahrenheit to Celsius conversion, enter:

```
return (value - 32) * 5 / 9
```

in JavaScript preprocessing parameters, which will be wrapped into a JavaScript function by server:

```
function (value)
{
    return (value - 32) * 5 / 9
}
```

The input parameter 'value' is always passed as a string. The return value is automatically coerced to string via ToString() method (if it fails, then the error is returned as string value), with a few exceptions:

- returning undefined value will result in an error;
- returning null value will cause the input value to be discarded, much like 'Discard value' preprocessing on 'Custom on fail' action.

Errors can be returned by throwing values/objects (normally either strings or Error objects).

For example:

```
if (value == 0)
    throw "Zero input value"
return 1/value
```

Each script has a 10-second execution timeout (depending on the script, it might take longer for the timeout to trigger); exceeding it will return error. A 512-megabyte heap limit is enforced.

The JavaScript preprocessing step bytecode is cached and reused when the step is applied next time. Any changes to the item's preprocessing steps will cause the cached script to be reset and recompiled later.

Consecutive runtime failures (3 in a row) will cause the engine to be reinitialized to mitigate the possibility of one script breaking the execution environment for the next scripts (this action is logged with DebugLevel 4 and higher).

JavaScript preprocessing is implemented with [Duktape](#) JavaScript engine.

See also: [Additional JavaScript objects and global functions](#)

Using macros in scripts

It is possible to use user macros in JavaScript code. If a script contains user macros, these macros are resolved by server/proxy before executing specific preprocessing steps. Note that when testing preprocessing steps in the frontend, macro values will not be pulled and need to be entered manually.

Note:

Context is ignored when a macro is replaced with its value. Macro value is inserted in the code as is, it is not possible to add additional escaping before placing the value in the JavaScript code. Please be advised that this can cause JavaScript errors in some cases.

In an example below, if received value exceeds a `{ $THRESHOLD }` macro value, the threshold value (if present) will be returned instead:

```
var threshold = '{ $THRESHOLD }';
return (!isNaN(threshold) && value > threshold) ? threshold : value;
```

Examples

The following examples illustrate how you can use JavaScript preprocessing.

Each example contains a brief description, a function body for JavaScript preprocessing parameters, and the preprocessing step result - value returned by the function.

Example 1: Convert a number (scientific notation to integer)

Convert the number "2.62128e+07" from scientific notation to an integer.

```
return (Number(value))
```

Value returned by the function: 26212800.

Example 2: Convert a number (binary to decimal)

Convert the binary number "11010010" to a decimal number.

```
return(parseInt(value,2))
```

Value returned by the function: 210.

Example 3: Round a number

Round the number "18.2345" to 2 digits.

```
return(Math.round(value* 100) / 100)
```

Value returned by the function: 18.23.

Example 4: Count letters in a string

Count the number of letters in the string "Zabbix".

```
return (value.length)
```

Value returned by the function: 6.

Example 5: Get time remaining

Get the remaining time (in seconds) until the expiration date of a certificate (Feb 12 12:33:56 2022 GMT).

```
var split = value.split(' '),
    MONTHS_LIST = ['Jan', 'Feb', 'Mar', 'Apr', 'May', 'Jun', 'Jul', 'Aug', 'Sep', 'Oct', 'Nov', 'Dec'],
    month_index = ('0' + (MONTHS_LIST.indexOf(split[0]) + 1)).slice(-2),
```

```
ISOdate = split[3] + '-' + month_index + '-' + split[1] + 'T' + split[2],
now = Date.now();
```

```
return parseInt((Date.parse(ISOdate) - now) / 1000);
```

Value returned by the function: 44380233.

Example 6: Remove JSON properties

Modify the JSON data structure by removing any properties with the key "data_size" or "index_size".

```
var obj=JSON.parse(value);

for (i = 0; i < Object.keys(obj).length; i++) {
  delete obj[i]["data_size"];
  delete obj[i]["index_size"];
}

return JSON.stringify(obj)
```

Value accepted by the function:

```
[
  {
    "table_name":"history",
    "data_size":"326.05",
    "index_size":"174.34"
  },
  {
    "table_name":"history_log",
    "data_size":"6.02",
    "index_size":"3.45"
  }
]
```

Value returned by the function:

```
[
  {
    "table_name":"history"
  },
  {
    "table_name":"history_log"
  }
]
```

Example 7: Convert Apache status to JSON

Convert the value received from a `web.page.get` Zabbix agent item (e.g., `web.page.get[http://127.0.0.1:80/server-status?auto]`) to a JSON object.

```
// Convert Apache status to JSON

// Split the value into substrings and put these substrings into an array
var lines = value.split('\n');

// Create an empty object "output"
var output = {};

// Create an object "workers" with predefined properties
var workers = {
  '_': 0, 'S': 0, 'R': 0, 'W': 0,
  'K': 0, 'D': 0, 'C': 0, 'L': 0,
  'G': 0, 'I': 0, '.': 0
};

// Add the substrings from the "lines" array to the "output" object as properties (key-value pairs)
```

```

for (var i = 0; i < lines.length; i++) {
    var line = lines[i].match(/([A-z0-9 ]+): (.*)/);

    if (line !== null) {
        output[line[1]] = isNaN(line[2]) ? line[2] : Number(line[2]);
    }
}

// Multiversion metrics
output.ServerUptimeSeconds = output.ServerUptimeSeconds || output.Uptime;
output.ServerVersion = output.ServerVersion || output.Server;

// Parse "Scoreboard" property to get the worker count
if (typeof output.Scoreboard === 'string') {
    for (var i = 0; i < output.Scoreboard.length; i++) {
        var char = output.Scoreboard[i];

        workers[char]++;
    }
}

// Add worker data to the "output" object
output.Workers = {
    waiting: workers['_'], starting: workers['S'], reading: workers['R'],
    sending: workers['W'], keepalive: workers['K'], dnslookup: workers['D'],
    closing: workers['C'], logging: workers['L'], finishing: workers['G'],
    cleanup: workers['I'], slot: workers['.']
};

// Return JSON string
return JSON.stringify(output);

```

Value accepted by the function:

```

HTTP/1.1 200 OK
Date: Mon, 27 Mar 2023 11:08:39 GMT
Server: Apache/2.4.52 (Ubuntu)
Vary: Accept-Encoding
Content-Encoding: gzip
Content-Length: 405
Content-Type: text/plain; charset=ISO-8859-1

127.0.0.1
ServerVersion: Apache/2.4.52 (Ubuntu)
ServerMPM: prefork
Server Built: 2023-03-08T17:32:01
CurrentTime: Monday, 27-Mar-2023 14:08:39 EEST
RestartTime: Monday, 27-Mar-2023 12:19:59 EEST
ParentServerConfigGeneration: 1
ParentServerMPMGeneration: 0
ServerUptimeSeconds: 6520
ServerUptime: 1 hour 48 minutes 40 seconds
Load1: 0.56
Load5: 0.33
Load15: 0.28
Total Accesses: 2476
Total kBytes: 8370
Total Duration: 52718
CPUUser: 8.16
CPUSystem: 3.44
CPUChildrenUser: 0
CPUChildrenSystem: 0
CPULoad: .177914

```

Uptime: 6520
ReqPerSec: .379755
BytesPerSec: 3461.58
BytesPerReq: 3461.58
DurationPerReq: 21.2916
BusyWorkers: 2
IdleWorkers: 6
Scoreboard: ____KW____

Value returned by the function:

```
{
  "Date": "Mon, 27 Mar 2023 11:08:39 GMT",
  "Server": "Apache/2.4.52 (Ubuntu)",
  "Vary": "Accept-Encoding",
  "Encoding": "gzip",
  "Length": 405,
  "Type": "text/plain; charset=ISO-8859-1",
  "ServerVersion": "Apache/2.4.52 (Ubuntu)",
  "ServerMPM": "prefork",
  "Server Built": "2023-03-08T17:32:01",
  "CurrentTime": "Monday, 27-Mar-2023 14:08:39 EEST",
  "RestartTime": "Monday, 27-Mar-2023 12:19:59 EEST",
  "ParentServerConfigGeneration": 1,
  "ParentServerMPMGeneration": 0,
  "ServerUptimeSeconds": 6520,
  "ServerUptime": "1 hour 48 minutes 40 seconds",
  "Load1": 0.56,
  "Load5": 0.33,
  "Load15": 0.28,
  "Total Accesses": 2476,
  "Total kBytes": 8370,
  "Total Duration": 52718,
  "CPUUser": 8.16,
  "CPUSystem": 3.44,
  "CPUChildrenUser": 0,
  "CPUChildrenSystem": 0,
  "CPULoad": 0.177914,
  "Uptime": 6520,
  "ReqPerSec": 0.379755,
  "BytesPerSec": 1314.55,
  "BytesPerReq": 3461.58,
  "DurationPerReq": 21.2916,
  "BusyWorkers": 2,
  "IdleWorkers": 6,
  "Scoreboard": "____KW____",
  "Workers": {
    "waiting": 6,
    "starting": 0,
    "reading": 0,
    "sending": 1,
    "keepalive": 1,
    "dnslookup": 0,
    "closing": 0,
    "logging": 0,
    "finishing": 0,
    "cleanup": 0,
    "slot": 142
  }
}
```

1 Additional JavaScript objects

Overview

This section describes Zabbix additions to the JavaScript language implemented with Duktape, and supported **global JavaScript functions**.

Built-in objects

Zabbix

The Zabbix object provides interaction with the internal Zabbix functionality.

Method	Description
<code>log(loglevel, message)</code>	Writes <message> into Zabbix log using <loglevel> log level (see configuration file <code>DebugLevel</code> parameter).

Example:

```
Zabbix.log(3, "this is a log entry written with 'Warning' log level")
```

You may use the following aliases:

Alias	Alias to
<code>console.log(object)</code>	<code>Zabbix.log(4, JSON.stringify(object))</code>
<code>console.warn(object)</code>	<code>Zabbix.log(3, JSON.stringify(object))</code>
<code>console.error(object)</code>	<code>Zabbix.log(2, JSON.stringify(object))</code>

Attention:

The total size of all logged messages is limited to 8 MB per script execution.

Method	Description
<code>sleep(delay)</code>	Delay JavaScript execution by <code>delay</code> milliseconds.

Example (delay execution by 15 seconds):

```
Zabbix.sleep(15000)
```

HttpRequest

This object encapsulates cURL handle allowing to make simple HTTP requests. Errors are thrown as exceptions.

Attention:

The initialization of multiple `HttpRequest` objects is limited to 10 per script execution.

Method	Description
<code>addHeader(value)</code>	Adds HTTP header field. This field is used for all following requests until cleared with the <code>clearHeader()</code> method. The total length of header fields that can be added to a single <code>HttpRequest</code> object is limited to 128 Kbytes (special characters and header names included).
<code>clearHeader()</code>	Clears HTTP header. If no header fields are set, <code>HttpRequest</code> will set <code>Content-Type</code> to <code>application/json</code> if the data being posted is JSON-formatted; <code>text/plain</code> otherwise.
<code>connect(url)</code>	Sends HTTP CONNECT request to the URL and returns the response.
<code>customRequest(method, url, data)</code>	Allows to specify any HTTP method in the first parameter. Sends the method request to the URL with optional <code>data</code> payload and returns the response.
<code>delete(url, data)</code>	Sends HTTP DELETE request to the URL with optional <code>data</code> payload and returns the response.
<code>getHeaders(<asArray>)</code>	Returns the object of received HTTP header fields. The <code>asArray</code> parameter may be set to <code>"true"</code> (e.g., <code>getHeaders(true)</code>), <code>"false"</code> or be undefined. If set to <code>"true"</code> , the received HTTP header field values will be returned as arrays; this should be used to retrieve the field values of multiple same-name headers. If not set or set to <code>"false"</code> , the received HTTP header field values will be returned as strings.
<code>get(url, data)</code>	Sends HTTP GET request to the URL with optional <code>data</code> payload and returns the response.
<code>head(url)</code>	Sends HTTP HEAD request to the URL and returns the response.

Method	Description
<code>options(url)</code>	Sends HTTP OPTIONS request to the URL and returns the response.
<code>patch(url, data)</code>	Sends HTTP PATCH request to the URL with optional <i>data</i> payload and returns the response.
<code>put(url, data)</code>	Sends HTTP PUT request to the URL with optional <i>data</i> payload and returns the response.
<code>post(url, data)</code>	Sends HTTP POST request to the URL with optional <i>data</i> payload and returns the response.
<code>getStatus()</code>	Returns the status code of the last HTTP request.
<code>setProxy(proxy)</code>	Sets HTTP proxy to "proxy" value. If this parameter is empty, then no proxy is used.
<code>setHttpAuth(bitmask, username, password)</code>	Sets enabled HTTP authentication methods (HTTPAUTH_BASIC, HTTPAUTH_DIGEST, HTTPAUTH_NEGOTIATE, HTTPAUTH_NTLM, HTTPAUTH_NONE) in the 'bitmask' parameter. The HTTPAUTH_NONE flag allows to disable HTTP authentication. Examples: <code>request.setHttpAuth(HTTPAUTH_NTLM HTTPAUTH_BASIC, username, password)</code> <code>request.setHttpAuth(HTTPAUTH_NONE)</code>
<code>trace(url, data)</code>	Sends HTTP TRACE request to the URL with optional <i>data</i> payload and returns the response.

Example:

```
try {
  Zabbix.log(4, 'jira webhook script value='+value);

  var result = {
    'tags': {
      'endpoint': 'jira'
    }
  },
  params = JSON.parse(value),
  req = new HttpRequest(),
  fields = {},
  resp;

  req.addHeader('Content-Type: application/json');
  req.addHeader('Authorization: Basic '+params.authentication);

  fields.summary = params.summary;
  fields.description = params.description;
  fields.project = {"key": params.project_key};
  fields.issuetype = {"id": params.issue_id};
  resp = req.post('https://jira.example.com/rest/api/2/issue/',
    JSON.stringify({"fields": fields})
  );

  if (req.getStatus() != 201) {
    throw 'Response code: '+req.getStatus();
  }

  resp = JSON.parse(resp);
  result.tags.issue_id = resp.id;
  result.tags.issue_key = resp.key;
} catch (error) {
  Zabbix.log(4, 'jira issue creation failed json : '+JSON.stringify({"fields": fields}));
  Zabbix.log(4, 'jira issue creation failed : '+error);

  result = {};
}

return JSON.stringify(result);
```

XML

The XML object allows the processing of XML data in the item and low-level discovery preprocessing and webhooks.

Attention:

In order to use XML object, server/proxy must be compiled with libxml2 support.

Method	Description
XML.query(data, expression)	Retrieves node content using XPath. Returns null if node is not found. expression - an XPath expression; data - XML data as a string.
XML.toJson(data)	Converts data in XML format to JSON.
XML.fromJson(object)	Converts data in JSON format to XML.

Example:

Input:

```
<menu>
  <food type = "breakfast">
    <name>Chocolate</name>
    <price>$5.95</price>
    <description></description>
    <calories>650</calories>
  </food>
</menu>
```

Output:

```
{
  "menu": {
    "food": {
      "@type": "breakfast",
      "name": "Chocolate",
      "price": "$5.95",
      "description": null,
      "calories": "650"
    }
  }
}
```

Serialization rules

XML to JSON conversion will be processed according to the following rules (for JSON to XML conversions reversed rules are applied):

1. XML attributes will be converted to keys that have their names prepended with '@'.

Example:

Input:

```
<xml foo="FOO">
  <bar>
    <baz>BAZ</baz>
  </bar>
</xml>
```

Output:

```
{
  "xml": {
    "@foo": "FOO",
    "bar": {
      "baz": "BAZ"
    }
  }
}
```

2. Self-closing elements (<foo/>) will be converted as having 'null' value.

Example:

Input:

```
<xml>
  <foo/>
</xml>
```

Output:

```
{
  "xml": {
    "foo": null
  }
}
```

3. Empty attributes (with "" value) will be converted as having empty string ("") value.

Example:

Input:

```
<xml>
  <foo bar="" />
</xml>
```

Output:

```
{
  "xml": {
    "foo": {
      "@bar": ""
    }
  }
}
```

4. Multiple child nodes with the same element name will be converted to a single key that has an array of values as its value.

Example:

Input:

```
<xml>
  <foo>BAR</foo>
  <foo>BAZ</foo>
  <foo>QUX</foo>
</xml>
```

Output:

```
{
  "xml": {
    "foo": ["BAR", "BAZ", "QUX"]
  }
}
```

5. If a text element has no attributes and no children, it will be converted as a string.

Example:

Input:

```
<xml>
  <foo>BAZ</foo>
</xml>
```

Output:

```
{
  "xml": {
    "foo": "BAZ"
  }
}
```

6. If a text element has no children but has attributes, text content will be converted to an element with the key '#text' and content as a value; attributes will be converted as described in the serialization rule 1.

Example:

Input:

```
<xml>
  <foo bar="BAR">
    BAZ
  </foo>
</xml>
```

Output:

```
{
  "xml": {
    "foo": {
      "@bar": "BAR",
      "#text": "BAZ"
    }
  }
}
```

Global JavaScript functions

Additional global JavaScript functions have been implemented with Duktape:

- `btoa(data)` - encodes the data to base64 string;
- `atob(base64_string)` - decodes base64 string as Uint8Array buffer.

```
try {
  b64 = btoa("test string");
  buffer = atob(b64);

  // Note that decoding logic depends on the data format of the buffer.
  decoded = String.fromCharCode.apply(this, [].slice.call(buffer));
}
catch (error) {
  return {'error.name' : error.name, 'error.message' : error.message};
}
```

- `md5(data)` - calculates the MD5 hash of the data
- `sha256(data)` - calculates the SHA256 hash of the data
- `hmac('<hash type>',key,data)` - returns HMAC hash as hex formatted string; MD5 and SHA256 hash types are supported; key and data parameters support binary data. Examples:
 - `hmac('md5',key,data)`
 - `hmac('sha256',key,data)`
- `sign(hash,key,data)` - returns calculated signature (RSA signature with SHA-256) as a string, where:

 hash - only 'sha256' is allowed, otherwise an error is thrown;
 key - the private key. It should correspond to PKCS#1 or PKCS#8 standard. The key can be provided in different forms:

 - with spaces instead of newlines;
 - with escaped or non-escaped '\n's instead of newlines;
 - without any newlines as a single-line string;
 - as a JSON-formatted string.

The key also can be loaded from a user macro/secret macro/vault.

data - the data that will be signed. It can be a string (binary data also supported) or buffer (Uint8Array/ArrayBuffer).
 OpenSSL or GnuTLS is used to calculate the signatures. If Zabbix was built without any of these encryption libraries, an error will be thrown ('missing OpenSSL or GnuTLS library').

2 Browser item JavaScript objects

Overview

This section describes Zabbix additions to the JavaScript language implemented with Duktape for use in the **Browser item** script. These additions supplement the JavaScript objects described on the [Additional JavaScript objects](#) page.

Browser

The `Browser` object manages WebDriver sessions, initializing a session upon creation and terminating it upon destruction. A single script can support up to four `Browser` objects.

To construct a `Browser` object, use the `new Browser(options)` syntax. The `options` (*JSON object*) parameter specifies browser options, usually the WebDriver options method result (for example, `Browser.chromeOptions()`).

The following methods are supported with the `Browser` object.

Method	Description
<code>navigate(url)</code>	Navigate to the specified URL.
<code>getUrl()</code>	Return a string of the opened page URL.
<code>getPageSource()</code>	Return a string of the opened page source.
<code>findElement(strategy, selector)</code>	Return an Element object with one element in the opened page (or return null if no elements match <code>strategy</code> and <code>selector</code>).
<code>findElements(strategy, target)</code>	Return an array of Element objects with multiple elements in the opened page (or return an empty array if no elements match location strategy and target).
<code>getCookies()</code>	Return an array of Cookie objects.
<code>addCookie(cookie)</code>	Set cookies.
<code>getScreenshot()</code>	Return a base64 encoded string representing an image of the browser's viewport.
<code>setScreenSize(x, y)</code>	Set the browser's viewport size.
<code>setScriptTimeout(timeout)</code>	Set script loading timeout.
<code>setSessionTimeout(timeout)</code>	Set session (page load) timeout.
<code>setElementWaitTimeout(timeout)</code>	Set element location strategy (implicit) timeout.
<code>collectPerfEntries(mark)</code>	Collect performance entries to retrieve with the <code>getResult()</code> method.
<code>getRawPerfEntries()</code>	Return an array of performance entry objects.
<code>getResult()</code>	Return a Result object with browser session statistics (error information, performance snapshots, etc.).

Method	Description
<code>getError()</code>	Return a <code>BrowserError</code> object with browser errors (or return null if there are no browser errors).
<code>setError(message)</code>	Set a custom error message to be included in the <code>Result</code> object.
<code>discardError()</code>	Discard the error to be returned in the <code>Result</code> object.
<code>getAlert()</code>	Return an <code>Alert</code> object with browser alerts (or return null if there are no browser alerts).
<code>chromeOptions()</code>	Return a <code>chromeOptions</code> object with predefined Chrome browser options.
<code>firefoxOptions()</code>	Return a <code>firefoxOptions</code> object with predefined Firefox browser options.
<code>safariOptions()</code>	Return a <code>safariOptions</code> object with predefined Safari browser options.
<code>edgeOptions()</code>	Return an <code>edgeOptions</code> object with predefined Edge browser options.
<code>switchFrame(target)</code>	Switch to the specified frame.
	Parameters: <code>target</code> - (browser element or integer, optional) Target frame. To select a frame by element, pass the element. To select a frame by index, pass the number. If left empty, will switch to the top-level browsing context.

All Browser methods can throw the following errors:

- `BrowserError` - derived from the `Error` object that is thrown if the `Browser` constructor fails; contains an additional `browser` property with a `Browser` object that threw this `BrowserError`.
- `WebdriverError` - derived from `BrowserError`; contains the same properties as the `BrowserError` object, which indicate if the error was generated in response to an error in the `WebDriver` response.

Element

The `Element` object is returned by the `Browser` object `findElement()/findElements()` methods and cannot be constructed directly.

The `Element` object represents an element in the web page and provides methods to interact with it.

The following methods are supported with the `Element` object.

Method	Description
<code>getAttribute(name)</code>	Return an attribute value string of the element attribute (or return null if the specified attribute was not found).
	Parameters: <code>name</code> - (string) Attribute name.
<code>getProperty(name)</code>	Return a property value string of the element property (or return null if the specified property was not found).
	Parameters: <code>name</code> - (string) Property name.
<code>getText()</code>	Return a text value string of the element text.
<code>click()</code>	Click on an element.
<code>clear()</code>	Clear the content of an editable element.
<code>sendKeys(keys)</code>	Send keys.
	Parameters: <code>keys</code> - (string) Keys to send.

Cookie

The `Cookie` object is returned by the `Browser` object `getCookies()` method and passed to the `addCookie()` method.

While the `Cookie` object does not have any methods, it can contain the following properties:

Property	Type	Description
name	string	Name of the cookie.
value	string	Value of the cookie.
path	string	Path for which the cookie is valid. Defaults to "/" if omitted when adding a cookie.
domain	string	Domain to which the cookie is visible. Defaults to the URL domain of the session's current browsing context's active document if omitted when adding a cookie.
secure	boolean	Indicates whether the cookie is secure. Defaults to <code>false</code> if omitted when adding a cookie.
httpOnly	boolean	Indicates whether the cookie is HTTP-only. Defaults to <code>false</code> if omitted when adding a cookie.
expiry	integer	Expiration time of the cookie (in seconds since the Unix Epoch). Must not be set if omitted when adding a cookie.
sameSite	string	The <code>sameSite</code> attribute of the cookie, which controls whether the cookie should be restricted to a first-party or same-site context. Can be set to either "Lax" or "Strict". Defaults to "None" if omitted when adding a cookie.

Alert

The `Alert` object represents a web page alert, is returned by `Browser` object `getAlert()` method, and cannot be constructed directly.

The `Alert` object contains the `text` property with the alert text (or `null` if there are no alerts).

The following methods are supported with the `Alert` object.

Method	Description
<code>accept()</code>	Accept the alert.
<code>dismiss()</code>	Dismiss the alert.

Result

The `Result` object contains session statistics and is returned by the `Browser` object `getResult()` method.

Typically, the `Result` object is stringified and returned from the script, and then parsed into dependent item values through preprocessing.

While the `Result` object does not have any methods, it can contain the following properties.

Property	Type	Description
duration	string	Session duration from session creation to result retrieval.
error	object	Error information.
http_status	integer	HTTP status returned by the WebDriver (or 0 if there are no WebDriver errors).
error_code	string	Error returned by the WebDriver (or empty string if there are no WebDriver errors).
message	string	WebDriver error message (or empty string if there are no WebDriver errors).
performance_data	object	Performance statistics.
summary	object	Performance summary.
navigation	object	Navigation summary.
resources	object	Resource summary.
details	array of objects	Performance statistics after each operation that could have resulted in navigation.
mark	string	<i>(optional)</i> Performance snapshot mark specified with the <code>collectPerfEntries()</code> method.
navigation	object	Navigation statistics.
resources	object	Resource summary for this step.
user	array of objects	Array of mark/measure type statistics.
marks	array of objects	Marked performance snapshot indexes.
name	string	Performance snapshot mark name.
index	integer	Performance snapshot index in details array.

6 CSV to JSON preprocessing

Overview

In this preprocessing step it is possible to convert CSV file data into JSON format. It's supported in:

- items (item prototypes)
- low-level discovery rules

Configuration

To configure a CSV to JSON preprocessing step:

- Go to the Preprocessing tab in **item/discovery rule** configuration
- Click on *Add*
- Select the *CSV to JSON* option

Item Tags Preprocessing 1

Preprocessing steps ?

Name	Parameters	Custom on fail	Actions
1: CSV to JSON	, " With header row	<input checked="" type="checkbox"/>	Test Remove

Custom on fail: Discard value Set value to Set error to

Add Test all steps

Type of information: Numeric (unsigned)

The first parameter allows to set a custom delimiter. Note that if the first line of CSV input starts with "Sep=" and is followed by a single UTF-8 character then that character will be used as the delimiter in case the first parameter is not set. If the first parameter is not set and a delimiter is not retrieved from the "Sep=" line, then a comma is used as a separator.

The second optional parameter allows to set a quotation symbol.

If the *With header row* checkbox is marked, the header line values will be interpreted as column names (see **Header processing** for more information).

If the *Custom on fail* checkbox is marked, the item will not become unsupported in case of a failed preprocessing step. Additionally, custom error handling options may be set: discard the value, set a specified value or set a specified error message.

Header processing

The CSV file header line can be processed in two different ways:

- If the *With header row* checkbox is marked - header line values are interpreted as column names. In this case the column names must be unique and the data row should not contain more columns than the header row.
- If the *With header row* checkbox is not marked - the header line is interpreted as data. Column names are generated automatically (1,2,3,4...).

CSV file example:

```
Nr,Item name,Key,Qty
1,active agent item,agent.hostname,33
"2","passive agent item","agent.version","44"
3,"active,passive agent items",agent.ping,55
```

Note:

A quotation character within a quoted field in the input must be escaped by preceding it with another quotation character.

Processing header line

JSON output when a header line is expected:

```
[
  {
    "Nr": "1",
    "Item name": "active agent item",
    "Key": "agent.hostname",
    "Qty": "33"
  },
  {
    "Nr": "2",
    "Item name": "passive agent item",
```

```

    "Key": "agent.version",
    "Qty": "44"
  },
  {
    "Nr": "3",
    "Item name": "active,passive agent items",
    "Key": "agent.ping",
    "Qty": "55"
  }
]

```

No header line processing

JSON output when a header line is not expected:

```

[
  {
    "1": "Nr",
    "2": "Item name",
    "3": "Key",
    "4": "Qty"
  },
  {
    "1": "1",
    "2": "active agent item",
    "3": "agent.hostname",
    "4": "33"
  },
  {
    "1": "2",
    "2": "passive agent item",
    "3": "agent.version",
    "4": "44"
  },
  {
    "1": "3",
    "2": "active,passive agent items",
    "3": "agent.ping",
    "4": "55"
  }
]

```

3 Item types

Overview

Item types cover various methods of acquiring data from your system. Each item type comes with its own set of supported item keys and required parameters.

The following items types are currently offered by Zabbix:

- Zabbix agent checks
- SNMP agent checks
- SNMP traps
- IPMI checks
- Simple checks
 - VMware monitoring
- Log file monitoring
- Calculated items
 - Aggregate calculations
- Zabbix internal checks
- SSH checks
- Telnet checks
- External checks
- Trapper items

- [JMX monitoring](#)
- [ODBC checks](#)
- [Dependent items](#)
- [HTTP checks](#)
- [Prometheus checks](#)
- [Script items](#)
- [Browser items](#)

Details for all item types are included in the subpages of this section. Even though item types offer a lot of options for data gathering, there are further options through [user parameters](#) or [loadable modules](#).

Some checks are performed by Zabbix server alone (as agent-less monitoring) while others require Zabbix agent or even Zabbix Java gateway (with JMX monitoring).

Attention:

If a particular item type requires a particular interface (like an IPMI check needs an IPMI interface on the host) that interface must exist in the host definition.

Multiple interfaces can be set in the host definition: Zabbix agent, SNMP agent, JMX and IPMI. If an item can use more than one interface, it will search the available host interfaces (in the order: Agent→SNMP→JMX→IPMI) for the first appropriate one to be linked with.

All items that return text (character, log, text types of information) can return whitespace only as well (where applicable) setting the return value to an empty string (supported since 2.0).

1 Zabbix agent

Overview

This section provides details on the item keys that use communication with Zabbix agent for data gathering.

There are [passive](#) and [active](#) agent checks. When configuring an item, you can select the required type:

- *Zabbix agent* - for passive checks
- *Zabbix agent (active)* - for active checks

Note that all item keys supported by Zabbix agent on Windows are also supported by the new generation Zabbix agent 2. See the [additional item keys](#) that you can use with the agent 2 only.

Supported item keys

The item keys that you can use with Zabbix agent are listed below.

The item keys are listed without parameters and additional information. Click on the item key to see the full details.

Item key	Description	Item group
kernel.maxfiles	The maximum number of opened files supported by OS.	Kernel
kernel.maxproc	The maximum number of processes supported by OS.	
kernel.openfiles	The number of currently open file descriptors.	
log	The monitoring of a log file.	Log monitoring
log.count	The count of matched lines in a monitored log file.	
logrt	The monitoring of a log file that is rotated.	
logrt.count	The count of matched lines in a monitored log file that is rotated.	
modbus.get	Reads Modbus data.	Modbus
net.dns	Checks the status of a DNS service.	Network
net.dns.perf	Checks the performance of a DNS service.	
net.dns.record	Performs a DNS query.	
net.if.collisions	The number of out-of-window collisions.	
net.if.discovery	The list of network interfaces.	
net.if.in	The incoming traffic statistics on a network interface.	
net.if.out	The outgoing traffic statistics on a network interface.	
net.if.total	The sum of incoming and outgoing traffic statistics on a network interface.	
net.tcp.listen	Checks if this TCP port is in LISTEN state.	
net.tcp.port	Checks if it is possible to make a TCP connection to the specified port.	
net.tcp.service	Checks if a service is running and accepting TCP connections.	
net.tcp.service.perf	Checks the performance of a TCP service.	

Item key	Description	Item group
net.tcp.socket.count	Returns the number of TCP sockets that match parameters.	
net.udp.listen	Checks if this UDP port is in LISTEN state.	
net.udp.service	Checks if a service is running and responding to UDP requests.	
net.udp.service.perf	Checks the performance of a UDP service.	
net.udp.socket.count	Returns the number of UDP sockets that match parameters.	
proc.cpu.util	The process CPU utilization percentage.	Processes
proc.get	The list of OS processes and their parameters.	
proc.mem	The memory used by the process in bytes.	
proc.num	The number of processes.	
sensor	Hardware sensor reading.	Sensors
system.boottime	The system boot time.	System
system.cpu.discovery	The list of detected CPUs/CPU cores.	
system.cpu.intr	The device interrupts.	
system.cpu.load	The CPU load.	
system.cpu.num	The number of CPUs.	
system.cpu.switches	The count of context switches.	
system.cpu.util	The CPU utilization percentage.	
system.hostname	The system host name.	
system.hw.chassis	The chassis information.	
system.hw.cpu	The CPU information.	
system.hw.devices	The listing of PCI or USB devices.	
system.hw.macaddr	The listing of MAC addresses.	
system.localtime	The system time.	
system.run	Run the specified command on the host.	
system.stat	The system statistics.	
system.sw.arch	The software architecture information.	
system.sw.os	The operating system information.	
system.sw.os.get	Detailed information about the operating system (version, type, distribution name, minor and major version, etc).	
system.sw.packages	The listing of installed packages.	
system.sw.packages.get	A detailed listing of installed packages.	
system.swap.in	The swap-in (from device into memory) statistics.	
system.swap.out	The swap-out (from memory onto device) statistics.	
system.swap.size	The swap space size in bytes or in percentage from total.	
system.uname	Identification of the system.	
system.uptime	The system uptime in seconds.	
system.users.num	The number of users logged in.	
vfs.dev.discovery	The list of block devices and their type.	Virtual file systems
vfs.dev.read	The disk read statistics.	
vfs.dev.write	The disk write statistics.	
vfs.dir.count	The directory entry count.	
vfs.dir.get	The directory entry list.	
vfs.dir.size	The directory size.	
vfs.file.cksum	The file checksum, calculated by the UNIX cksum algorithm.	
vfs.file.contents	Retrieving the contents of a file.	
vfs.file.exists	Checks if the file exists.	
vfs.file.get	Returns information about a file.	
vfs.file.md5sum	The MD5 checksum of file.	
vfs.file.owner	Retrieves the owner of a file.	
vfs.file.permissions	Returns a 4-digit string containing the octal number with UNIX permissions.	
vfs.file.regexp	Retrieve a string in the file.	
vfs.file.regmatch	Find a string in the file.	
vfs.file.size	The file size.	
vfs.file.time	The file time information.	
vfs.fs.discovery	The list of mounted filesystems with their type and mount options.	
vfs.fs.get	The list of mounted filesystems with their type, available disk space, inode statistics and mount options.	
vfs.fs.inode	The number or percentage of inodes.	
vfs.fs.size	The disk space in bytes or in percentage from total.	
vm.memory.size	The memory size in bytes or in percentage from total.	Virtual memory

Item key	Description	Item group
web.page.get	Get the content of a web page.	Web monitoring
web.page.perf	The loading time of a full web page.	
web.page.regex	Find a string on the web page.	
agent.hostmetadata	The agent host metadata.	Zabbix
agent.hostname	The agent host name.	
agent.ping	The agent availability check.	
agent.variant	The variant of Zabbix agent (Zabbix agent or Zabbix agent 2).	
agent.version	The version of Zabbix agent.	
zabbix.stats	Returns a set of Zabbix server or proxy internal metrics remotely.	
zabbix.stats	Returns the number of monitored items in the queue which are delayed on Zabbix server or proxy remotely.	

Supported platforms

Except where specified differently in the item details, the agent items (and all parameters) are supported on:

- **Linux**
- **FreeBSD**
- **Solaris**
- **HP-UX**
- **AIX**
- **MacOS X**
- **OpenBSD**
- **NetBSD**

Many agent items are also supported on **Windows**. See the [Windows agent item](#) page for details.

Item key details

Parameters without angle brackets are mandatory. Parameters marked with angle brackets < > are optional.

kernel.maxfiles

 The maximum number of opened files supported by OS.
 Return value: *Integer*.
 Supported platforms: Linux, FreeBSD, MacOS X, OpenBSD, NetBSD.

kernel.maxproc

 The maximum number of processes supported by OS.
 Return value: *Integer*.
 Supported platforms: Linux 2.6 and later, FreeBSD, Solaris, MacOS X, OpenBSD, NetBSD.

kernel.openfiles

 The number of currently open file descriptors.
 Return value: *Integer*.
 Supported platforms: Linux (the item may work on other UNIX-like platforms).

log[file,<regex>,<encoding>,<maxlines>,<mode>,<output>,<maxdelay>,<options>,<persistent dir>]

 The monitoring of a log file.
 Return value: *Log*.
 See **supported platforms**.

Parameters:

- **file** - the full path and name of a log file;

- **regex** - a regular **expression** describing the required pattern;

- **encoding** - the code page **identifier**;

- **maxlines** - the maximum number of new lines per second the agent will send to Zabbix server or proxy. This parameter overrides the value of 'MaxLinesPerSecond' in `zabbix_agentd.conf`;

- **mode** - possible values: *all* (default) or *skip* - skip processing of older data (affects only newly created items);

- **output** - an optional output formatting template. The `\0` escape sequence is replaced with the matched part of text (from the first character where match begins until the character where match ends) while an `\N` (where N=1...9) escape sequence is replaced with Nth matched group (or an empty string if the N exceeds the number of captured groups);

- **maxdelay** - the maximum delay in seconds. Type: float. Values: 0 - (default) never ignore log file lines; > 0.0 - ignore older lines in order to get the most recent lines analyzed within "maxdelay" seconds. Read the **maxdelay** notes before using it!

- **options** - additional options:
`mtime-noread` - non-unique records, reread only if the file size changes (ignore modification time change). (This parameter is deprecated since 5.0.2, because now mtime is ignored.)

- **persistent dir** (only in zabbix_agentd on Unix systems; not supported in Zabbix agent 2) - the absolute pathname of directory where to store persistent files. See also additional notes on [persistent files](#).

Comments:

- The item must be configured as an **active check**;
- If the file is missing or permissions do not allow access, the item turns unsupported;
- If output is left empty - the whole line containing the matched text is returned. Note that all global regular expression types except 'Result is TRUE' always return the whole matched line and the output parameter is ignored.
- Content extraction using the output parameter takes place on the agent.

Examples:

```
log[/var/log/syslog]
log[/var/log/syslog,error]
log[/home/zabbix/logs/logfile,,,100]
```

Example of using the output parameter for extracting a number from log record:

```
log[/app1/app.log,"task run [0-9.]+ sec, processed ([0-9]+) records, [0-9]+ errors",,,,1] #this item will
```

Example of using the output parameter for rewriting a log record before sending to server:

```
log[/app1/app.log,"([0-9 :-]+) task run ([0-9.]+) sec, processed ([0-9]+) records, ([0-9]+) errors",,,,1]
log.count[file,<regex>,<encoding>,<maxproclines>,<mode>,<maxdelay>,<options>,<persistent dir>]
```

 The count of matched lines in a monitored log file.
 Return value: *Integer*.
 See [supported platforms](#).

Parameters:

- **file** - the full path and name of log file;

- **regex** - a regular **expression** describing the required pattern;

- **encoding** - the code page **identifier**;

- **maxproclines** - the maximum number of new lines per second the agent will analyze (cannot exceed 10000). The default value is 10*'MaxLinesPerSecond' in [zabbix_agentd.conf](#).

- **mode** - possible values: *all* (default) or *skip* - skip processing of older data (affects only newly created items).

- **maxdelay** - the maximum delay in seconds. Type: float. Values: 0 - (default) never ignore log file lines; > 0.0 - ignore older lines in order to get the most recent lines analyzed within "maxdelay" seconds. Read the **maxdelay** notes before using it!

- **options** - additional options:
mtime-noread - non-unique records, reread only if the file size changes (ignore modification time change). (This parameter is deprecated since 5.0.2, because now mtime is ignored).

- **persistent dir** (only in zabbix_agentd on Unix systems; not supported in Zabbix agent 2) - the absolute pathname of directory where to store persistent files. See also additional notes on [persistent files](#).

Comments:

- The item must be configured as an **active check**;
- Matching lines are counted in the new lines since the last log check by the agent, and thus depend on the item update interval;
- If the file is missing or permissions do not allow access, the item turns unsupported.

```
logrt[file regex,<regex>,<encoding>,<maxlines>,<mode>,<output>,<maxdelay>,<options>,<persistent dir>]
```

 The monitoring of a log file that is rotated.
 Return value: *Log*.
 See [supported platforms](#).

Parameters:

- **file regex** - the absolute path to file, with the file name specified using a regular **expression**. Note that the regular expression applies only to the file name and does not need to match the entire name (e.g., /path/to/agent will match zabbix_agentd.log).

- **regex** - a regular **expression** describing the required content pattern.

- **encoding** - the code page **identifier**.

- **maxlines** - the maximum number of new lines per second the agent will send to Zabbix server or proxy. This parameter overrides the value of 'MaxLinesPerSecond' in [zabbix_agentd.conf](#).

- **mode** - possible values: *all* (default) or *skip* - skip processing of older data (affects only newly created items).

- **output** - an optional output formatting template. The **\0** escape sequence is replaced with the matched part of text (from the first character where match begins until the character where match ends) while an **\N** (where N=1...9) escape sequence is replaced with Nth matched group (or an empty string if the N exceeds the number of captured groups).

- **maxdelay** - the maximum delay in seconds. Type: float. Values: 0 - (default) never ignore log file lines; > 0.0 - ignore older lines in order to get the most recent lines analyzed within "maxdelay" seconds. Read the **maxdelay** notes before using it!

- **options** - the type of log file rotation and other options. Possible values: `rotate` (default), `copytruncate` - note that `copytruncate` cannot be used together with `maxdelay`. In this case `maxdelay` must be 0 or not specified; see `copytruncate` notes, `mtime-reread` - non-unique records, reread if modification time or size changes (default), `mtime-noread` - non-unique records, reread only if the size changes (ignore modification time change).
- **persistent dir** (only in `zabbix_agentd` on Unix systems; not supported in Zabbix agent 2) - the absolute pathname of directory where to store persistent files. See also additional notes on `persistent files`.

Comments:

- The item must be configured as an `active check`;
- Log rotation is based on the last modification time of files;
- Note that `logrt` is designed to work with one currently active log file, with several other matching inactive files rotated. If, for example, a directory has many active log files, a separate `logrt` item should be created for each one. Otherwise if one `logrt` item picks up too many files it may lead to exhausted memory and a crash of monitoring.
- If `output` is left empty - the whole line containing the matched text is returned. Note that all global regular expression types except 'Result is TRUE' always return the whole matched line and the `output` parameter is ignored.
- Content extraction using the `output` parameter takes place on the agent.
- In the `file regexp` parameter, the log directory path and log file regular expression must be separated by the correct directory separator:
 - on Windows, the separator must be a backslash (`\`); forward slashes may be tolerated at other positions, except the one that separates the log directory path and the log file regular expression (see examples below).
 - on other systems, it must be a forward slash (`/`).

Examples for Windows:

```
logrt["c:/dir1/dir2/dir3\filename.*\.log","pattern_to_match"] #this item will collect data from log files
logrt["//example.com/share/dir1/dir2/dir3\filename.*\.log","pattern_to_match"] #this item will collect data
```

Examples for other systems:

```
logrt["/home/zabbix/logs/~logfile[0-9]{1,3}$",,,100] #this item will match a file like "logfile1" (will not match "logfile10")
logrt["/home/user/~logfile._*[0-9]{1,3}$","pattern_to_match","UTF-8",100] #this item will collect data from
```

Example of using the `output` parameter for extracting a number from log record:

```
logrt[/app1/~test.*log$,"task run [0-9.]+ sec, processed ([0-9.]+) records, [0-9.]+ errors",,,\1] #this item will return
```

Example of using the `output` parameter for rewriting a log record before sending to server:

```
logrt[/app1/~test.*log$,"([0-9 :-]+) task run ([0-9.]+) sec, processed ([0-9.]+) records, ([0-9.]+) errors",,,"count"]
logrt.count[file regexp,<regexp>,<encoding>,<maxproclines>,<mode>,<maxdelay>,<options>,<persistent dir>]
```

 The count of matched lines in a monitored log file that is rotated.
 Return value: *Integer*.
 See `supported platforms`.

Parameters:

- **file regexp** - the absolute path to file, with the file name specified using a regular `expression`. Note that the regular expression applies only to the file name and does not need to match the entire name (e.g., `/path/to/agent` will match `zabbix_agentd.log`).
- **regexp** - a regular `expression` describing the required pattern.
- **encoding** - the code page `identifier`.
- **maxproclines** - the maximum number of new lines per second the agent will analyze (cannot exceed 10000). The default value is `10*MaxLinesPerSecond` in `zabbix_agentd.conf`.
- **mode** - possible values: `all` (default) or `skip` - skip processing of older data (affects only newly created items).
- **maxdelay** - the maximum delay in seconds. Type: float. Values: 0 - (default) never ignore log file lines; > 0.0 - ignore older lines in order to get the most recent lines analyzed within "maxdelay" seconds. Read the `maxdelay` notes before using it!
- **options** - the type of log file rotation and other options. Possible values: `rotate` (default), `copytruncate` - note that `copytruncate` cannot be used together with `maxdelay`. In this case `maxdelay` must be 0 or not specified; see `copytruncate` notes, `mtime-reread` - non-unique records, reread if modification time or size changes (default), `mtime-noread` - non-unique records, reread only if the size changes (ignore modification time change).
- **persistent dir** (only in `zabbix_agentd` on Unix systems; not supported in Zabbix agent 2) - the absolute pathname of directory where to store persistent files. See also additional notes on `persistent files`.

Comments:

- The item must be configured as an `active check`;
- Matching lines are counted in the new lines since the last log check by the agent, and thus depend on the item update interval;

- Log rotation is based on the last modification time of files;
- In the file `regex` parameter, the log directory path and log file regular expression must be separated by the correct directory separator:
 - on Windows, the separator must be a backslash (`\`); forward slashes may be tolerated at other positions, except the one that separates the log directory path and the log file regular expression (see examples below).
 - on other systems, it must be a forward slash (`/`).

Examples for Windows:

```
logrt.count["c:/dir1/dir2/dir3\\filename.*\\.log","pattern_to_match"] #this item will count the number of matches for
logrt.count["//example.com/share/dir1/dir2/dir3\\filename.*\\.log","pattern_to_match"] #this item will count the number of matches for
```

Examples for other systems:

```
logrt.count["/home/zabbix/logs/^logfile[0-9]{1,3}$",,,100] #this item will count the number of matches for
logrt.count["/home/user/^logfile_.*_[0-9]{1,3}$","pattern_to_match","UTF-8",100] #this item will count the number of matches for
modbus.get[endpoint,<slave id>,<function>,<address>,<count>,<type>,<endianness>,<offset>]
```

 Reads Modbus data.
 Return value: *JSON object*.
 Supported platforms: Linux.

Parameters:

- **endpoint** - the endpoint defined as `protocol://connection_string`;
- **slave id** - the slave ID;
- **function** - the Modbus function;
- **address** - the address of first registry, coil or input;
- **count** - the number of records to read;
- **type** - the type of data;
- **endianness** - the endianness configuration;
- **offset** - the number of registers, starting from 'address', the results of which will be discarded.

See a [detailed description](#) of parameters.

```
net.dns[<ip>,name,<type>,<timeout>,<count>,<protocol>]
```

 Checks the status of a DNS service.
 Return values: 0 - DNS resolution failed (DNS server did not respond or returned an error); 1 - DNS resolution succeeded.
 See [supported platforms](#).

Parameters:

- **ip** (ignored on Windows unless using Zabbix agent 2) - the IP address of DNS server (leave empty for the default DNS server);
- **name** - the DNS name to query;
- **type** - the record type to be queried (default is *SOA*);
- **timeout** (ignored on Windows unless using Zabbix agent 2) - the timeout for the request in seconds (default is 1 second);
- **count** (ignored on Windows unless using Zabbix agent 2) - the number of tries for the request (default is 2);
- **protocol** - the protocol used to perform DNS queries: *udp* (default) or *tcp*.

Comments:

- The possible values for `type` are: *ANY, A, NS, CNAME, MB, MG, MR, PTR, MD, MF, MX, SOA, NULL, WKS* (not supported for Zabbix agent on Windows, Zabbix agent 2 on all OS), *HINFO, MINFO, TXT, SRV*
- For reverse DNS lookups (when `type` is set to *PTR*), you can provide the DNS name in both reversed and non-reversed format (see examples below). Note that when *PTR* record is requested, the DNS name is actually an IP address.
- Internationalized domain names are not supported, please use IDNA encoded names instead.

Examples:

```
net.dns[198.51.100.1,example.com,MX,2,1]
```

```
net.dns[,198.51.100.1,PTR]
net.dns[,1.100.51.198.in-addr.arpa,PTR]
```

```
net.dns[,2a00:1450:400f:800::200e,PTR]
net.dns[,e.0.0.2.0.0.0.0.0.0.0.0.0.0.0.0.0.0.0.0.0.0.0.8.0.f.0.0.4.0.5.4.1.0.0.a.2.ip6.arpa,PTR]
```

```
net.dns.perf[<ip>,name,<type>,<timeout>,<count>,<protocol>]
```

 Checks the performance of a DNS service.
 Return value: *Float* (0 - service is down; seconds - the number of seconds spent waiting for a response from the service).
 See [supported platforms](#).

Parameters:

- **ip** (ignored on Windows unless using Zabbix agent 2) - the IP address of DNS server (leave empty for the default DNS server);
- **name** - the DNS name to query;
- **type** - the record type to be queried (default is *SOA*);
- **timeout** (ignored on Windows unless using Zabbix agent 2) - the timeout for the request in seconds (default is 1 second);
- **count** (ignored on Windows unless using Zabbix agent 2) - the number of tries for the request (default is 2);
- **protocol** - the protocol used to perform DNS queries: *udp* (default) or *tcp*.

Comments:

- The possible values for type are:
ANY, A, NS, CNAME, MB, MG, MR, PTR, MD, MF, MX, SOA, NULL, WKS (not supported for Zabbix agent on Windows, Zabbix agent 2 on all OS), *HINFO, MINFO, TXT, SRV*
- For reverse DNS lookups (when type is set to *PTR*), you can provide the DNS name in both reversed and non-reversed format (see examples below). Note that when PTR record is requested, the DNS name is actually an IP address.
- Internationalized domain names are not supported, please use IDNA encoded names instead.
- The item returns a response time instead of 0 when the DNS server responds with an error code (for example, *NXDOMAIN* or *SERVFAIL*).

Examples:

```
net.dns.perf [198.51.100.1,example.com,MX,2,1]
```

```
net.dns.perf [,198.51.100.1,PTR]
```

```
net.dns.perf [,1.100.51.198.in-addr.arpa,PTR]
```

```
net.dns.perf [,2a00:1450:400f:800::200e,PTR]
```

```
net.dns.perf [,e.0.0.2.0.0.0.0.0.0.0.0.0.0.0.0.0.0.0.0.0.8.0.f.0.0.4.0.5.4.1.0.0.a.2.ip6.arpa,PTR]
```

```
net.dns.record[<ip>,name,<type>,<timeout>,<count>,<protocol>]
```

 Performs a DNS query.
 Return value: a character string with the required type of information.
 See [supported platforms](#).

Parameters:

- **ip** (ignored on Windows unless using Zabbix agent 2) - the IP address of DNS server (leave empty for the default DNS server);
- **name** - the DNS name to query;
- **type** - the record type to be queried (default is *SOA*);
- **timeout** (ignored on Windows unless using Zabbix agent 2) - the timeout for the request in seconds (default is 1 second);
- **count** (ignored on Windows unless using Zabbix agent 2) - the number of tries for the request (default is 2);
- **protocol** - the protocol used to perform DNS queries: *udp* (default) or *tcp*.

Comments:

- The possible values for type are:
ANY, A, NS, CNAME, MB, MG, MR, PTR, MD, MF, MX, SOA, NULL, WKS (not supported for Zabbix agent on Windows, Zabbix agent 2 on all OS), *HINFO, MINFO, TXT, SRV*
- For reverse DNS lookups (when type is set to *PTR*), you can provide the DNS name in reversed or non-reversed format (see examples below). Note that when PTR record is requested, the DNS name is actually an IP address.
- Internationalized domain names are not supported, please use IDNA encoded names instead.

Examples:

```
net.dns.record[198.51.100.1,example.com,MX,2,1]
```

```
net.dns.record[,198.51.100.1,PTR]
```

```
net.dns.record[,1.100.51.198.in-addr.arpa,PTR]
```

```
net.dns.record[,2a00:1450:400f:800::200e,PTR]
```

```
net.dns.record[,e.0.0.2.0.0.0.0.0.0.0.0.0.0.0.0.0.0.0.0.0.8.0.f.0.0.4.0.5.4.1.0.0.a.2.ip6.arpa,PTR]
```

```
net.if.collisions[if]
```

 The number of out-of-window collisions.
 Return value: *Integer*.
 [Supported platforms](#): Linux, FreeBSD, Solaris, AIX, MacOS X, OpenBSD, NetBSD. Root privileges are required on NetBSD.

Parameter:

- **if** - network interface name

```
net.if.discovery
```

 The list of network interfaces. Used for low-level discovery.
 Return value: *JSON object*.
 [Supported platforms](#): Linux, FreeBSD, Solaris, HP-UX, AIX, OpenBSD, NetBSD.

net.if.in[if,<mode>]

 The incoming traffic statistics on a network interface.
 Return value: *Integer*.
 Supported platforms: Linux, FreeBSD, Solaris⁵, HP-UX, AIX, MacOS X, OpenBSD, NetBSD. Root privileges are required on NetBSD.

Parameters:

- **if** - network interface name (Unix); network interface full description or IPv4 address; or, if in braces, network interface GUID (Windows);
- **mode** - possible values:
bytes - number of bytes (default)
packets - number of packets
errors - number of errors
dropped - number of dropped packets
overruns (fifo) - the number of FIFO buffer errors
frame - the number of packet framing errors
compressed - the number of compressed packets received by the device driver
multicast - the number of multicast frames received by the device driver

Comments:

- You may use this key with the *Change per second* preprocessing step in order to get the bytes-per-second statistics;
- The *dropped* mode is supported only on Linux, FreeBSD, HP-UX, MacOS X, OpenBSD, NetBSD;
- The *overruns*, *frame*, *compressed*, *multicast* modes are supported only on Linux;
- On HP-UX this item does not provide details on loopback interfaces (e.g. lo0).

Examples:

```
net.if.in[eth0]
net.if.in[eth0,errors]

net.if.out[if,<mode>]
```

 The outgoing traffic statistics on a network interface.
 Return value: *Integer*.
 Supported platforms: Linux, FreeBSD, Solaris⁵, HP-UX, AIX, MacOS X, OpenBSD, NetBSD. Root privileges are required on NetBSD.

Parameters:

- **if** - network interface name (Unix); network interface full description or IPv4 address; or, if in braces, network interface GUID (Windows);
- **mode** - possible values:
bytes - number of bytes (default)
packets - number of packets
errors - number of errors
dropped - number of dropped packets
overruns (fifo) - the number of FIFO buffer errors
collisions (colls) - the number of collisions detected on the interface
carrier - the number of carrier losses detected by the device driver
compressed - the number of compressed packets transmitted by the device driver

Comments:

- You may use this key with the *Change per second* preprocessing step in order to get the bytes-per-second statistics;
- The *dropped* mode is supported only on Linux, HP-UX;
- The *overruns*, *collision*, *carrier*, *compressed* modes are supported only on Linux;
- On HP-UX this item does not provide details on loopback interfaces (e.g. lo0).

Examples:

```
net.if.out[eth0]
net.if.out[eth0,errors]

net.if.total[if,<mode>]
```

 The sum of incoming and outgoing traffic statistics on a network interface.
 Return value: *Integer*.
 Supported platforms: Linux, FreeBSD, Solaris⁵, HP-UX, AIX, MacOS X, OpenBSD, NetBSD. Root privileges are required on NetBSD.

Parameters:

- **if** - network interface name (Unix); network interface full description or IPv4 address; or, if in braces, network interface GUID (Windows);
- **mode** - possible values:
bytes - number of bytes (default)
packets - number of packets
errors - number of errors
dropped - number of dropped packets
overruns (fifo) - the number of FIFO buffer errors
collisions (colls) - the number of collisions detected on the interface
compressed - the number of compressed packets transmitted or received by the device driver

Comments:

- You may use this key with the *Change per second* preprocessing step in order to get the bytes-per-second statistics;
- The *dropped* mode is supported only on Linux, HP-UX. Dropped packets are supported only if both `net.if.in` and `net.if.out` work for dropped packets on your platform.
- The *overruns*, *collision*, *compressed* modes are supported only on Linux;
- On HP-UX this item does not provide details on loopback interfaces (e.g. lo0).

Examples:

```
net.if.total[eth0]
net.if.total[eth0,errors]

net.tcp.listen[port]
```

 Checks if this TCP port is in LISTEN state.
 Return values: 0 - it is not in LISTEN state; 1 - it is in LISTEN state.
 Supported platforms: Linux, FreeBSD, Solaris, MacOS X.

Parameter:

- **port** - TCP port number

On Linux kernels 2.6.14 and above, the information about listening TCP sockets is obtained from the kernel's NETLINK interface, if possible. Otherwise, the information is retrieved from `/proc/net/tcp` and `/roc/net/tcp6` files.

Example:

```
net.tcp.listen[80]

net.tcp.port[<ip>,port]
```

 Checks if it is possible to make a TCP connection to the specified port.
 Return values: 0 - cannot connect; 1 - can connect.
 See **supported platforms**.

Parameters:

- **ip** - the IP address or DNS name (default is 127.0.0.1);
- **port** - the port number.

Comments:

- For simple TCP performance testing use `net.tcp.service.perf[tcp,<ip>,<port>]`;
- These checks may result in additional messages in system daemon logfiles (SMTP and SSH sessions being logged usually).

Example:

```
net.tcp.port[,80] #this item can be used to test the web server availability running on port 80
net.tcp.service[service,<ip>,<port>]
```

 Checks if a service is running and accepting TCP connections.
 Return values: 0 - service is down; 1 - service is running.
 See **supported platforms**.

Parameters:

- **service** - *ssh, ldap, smtp, ftp, http, pop, nntp, imap, tcp, https, or telnet* (see **details**);
- **ip** - the IP address or DNS name (default is 127.0.0.1);
- **port** - the port number (by default the standard service port number is used).

Comments:

- These checks may result in additional messages in system daemon logfiles (SMTP and SSH sessions being logged usually);
- Checking of encrypted protocols (like IMAP on port 993 or POP on port 995) is currently not supported. As a workaround, please use `net.tcp.port[]` for checks like these.
- Checking of LDAP and HTTPS on Windows is only supported by Zabbix agent 2;
- The telnet check looks for a login prompt (':' at the end).

Example:

```
net.tcp.service[ftp,45] #this item can be used to test the availability of FTP server on TCP port 45
net.tcp.service.perf[service,<ip>,<port>]
```

 Checks the performance of a TCP service.
 Return values: *Float* (0 - service is down; seconds - the number of seconds spent waiting for a response from the service).
 See **supported platforms**.

Parameters:

- **service** - *ssh, ldap, smtp, ftp, http, pop, nntp, imap, tcp, https, or telnet* (see **details**);
- **ip** - the IP address or DNS name (default is 127.0.0.1);
- **port** - the port number (by default the standard service port number is used).

Comments:

- Checking of encrypted protocols (like IMAP on port 993 or POP on port 995) is currently not supported. As a workaround, please use `net.tcp.service.perf[tcp,<ip>,<port>]` for checks like these.

- The telnet check looks for a login prompt (':' at the end).

Example:

```
net.tcp.service.perf[ssh] #this item can be used to test the speed of initial response from the SSH server
net.tcp.socket.count[<laddr>,<lport>,<raddr>,<rport>,<state>]
```

 Returns the number of TCP sockets that match parameters.
 Return value: *Integer*.
 Supported platforms: Linux.

Parameters:

- **laddr** - the local IPv4/6 address or CIDR subnet;
- **lport** - the local port number or service name;
- **raddr** - the remote IPv4/6 address or CIDR subnet;
- **rport** - the remote port number or service name;
- **state** - the connection state (*established, syn_sent, syn_recv, fin_wait1, fin_wait2, time_wait, close, close_wait, last_ack, listen, closing*).

Example:

```
net.tcp.socket.count[,80,,,established] #the number of connections to local TCP port 80 in the established
net.udp.listen[port]
```

 Checks if this UDP port is in LISTEN state.
 Return values: 0 - it is not in LISTEN state; 1 - it is in LISTEN state.
 Supported platforms: Linux, FreeBSD, Solaris, MacOS X.

Parameter:

- **port** - UDP port number

Example:

```
net.udp.listen[68]
net.udp.service[service,<ip>,<port>]
```

 Checks if a service is running and responding to UDP requests.
 Return values: 0 - service is down; 1 - service is running.
 See **supported platforms**.

Parameters:

- **service** - *ntp* (see **details**);
- **ip** - the IP address or DNS name (default is 127.0.0.1);
- **port** - the port number (by default the standard service port number is used).

Example:

```
net.udp.service[ntp,,45] #this item can be used to test the availability of NTP service on UDP port 45
net.udp.service.perf[service,<ip>,<port>]
```

 Checks the performance of a UDP service.
 Return values: *Float* (0 - service is down; seconds - the number of seconds spent waiting for a response from the service).
 See **supported platforms**.

Parameters:

- **service** - *ntp* (see **details**);
- **ip** - the IP address or DNS name (default is 127.0.0.1);
- **port** - the port number (by default the standard service port number is used).

Example:

```
net.udp.service.perf[ntp] #this item can be used to test response time from NTP service
net.udp.socket.count[<laddr>,<lport>,<raddr>,<rport>,<state>]
```

 Returns the number of UDP sockets that match parameters.
 Return value: *Integer*.
 Supported platforms: Linux.

Parameters:

- **laddr** - the local IPv4/6 address or CIDR subnet;
- **lport** - the local port number or service name;
- **raddr** - the remote IPv4/6 address or CIDR subnet;
- **rport** - the remote port number or service name;
- **state** - the connection state (*established, unconn*).

Example:

```
net.udp.socket.count[,,,established] #returns the number of UDP sockets in the connected state  
proc.cpu.util[<name>,<user>,<type>,<cmdline>,<mode>,<zone>]
```

 The process CPU utilization percentage.
 Return value: *Float*.
 Supported platforms: Linux, Solaris⁶.

Parameters:

- **name** - the process name (default is *all processes*);
- **user** - the user name (default is *all users*);
- **type** - the CPU utilization type: *total* (default), *user*, or *system*;
- **cmdline** - filter by command line (it is a regular **expression**);
- **mode** - the data gathering mode: *avg1* (default), *avg5*, or *avg15*;
- **zone** - the target zone: *current* (default) or *all*. This parameter is supported on Solaris only.

Comments:

- The returned value is based on a single CPU core utilization percentage. For example, the CPU utilization of a process fully using two cores is 200%.
- The process CPU utilization data is gathered by a collector which supports the maximum of 1024 unique (by name, user and command line) queries. Queries not accessed during the last 24 hours are removed from the collector.
- When setting the zone parameter to *current* (or default) in case the agent has been compiled on a Solaris without zone support, but running on a newer Solaris where zones are supported, then the agent will return NOTSUPPORTED (the agent cannot limit results to only the current zone). However, *all* is supported in this case.

Examples:

```
proc.cpu.util[,root] #CPU utilization of all processes running under the "root" user  
proc.cpu.util[zabbix_server,zabbix] #CPU utilization of all zabbix_server processes running under the zabbix user  
proc.get[<name>,<user>,<cmdline>,<mode>]
```

 The list of OS processes and their parameters. Can be used for low-level discovery.
 Return value: *JSON object*.
 Supported platforms: Linux, FreeBSD, Windows, OpenBSD, NetBSD.

Parameters:

- **name** - the process name (default *all processes*);
- **user** - the user name (default *all users*);
- **cmdline** - filter by command line (it is a regular **expression**). This parameter is not supported for Windows; on other platforms it is not supported if mode is set to 'summary'.
- **mode** - possible values:
process (default), *thread* (not supported for NetBSD), *summary*. See a list of **process parameters** returned for each mode and OS.

Comments:

- If a value cannot be retrieved, for example, because of an error (process already died, lack of permissions, system call failure), -1 will be returned;
- See **notes** on selecting processes with name and cmdline parameters (Linux-specific).

Examples:

```
proc.get[zabbix_server,zabbix,,process] #list of all zabbix_server processes running under the zabbix user  
proc.get[java,,,thread] #list of all Java processes, returns one entry per thread  
proc.get[,zabbix,,summary] #combined data for processes of each type running under the zabbix user, returns  
proc.mem[<name>,<user>,<mode>,<cmdline>,<memtype>]
```

 The memory used by the process in bytes.
 Return value: *Integer* - with mode as *max*, *min*, *sum*; *Float* - with mode as *avg*
 Supported platforms: Linux, FreeBSD, Solaris, AIX, OpenBSD, NetBSD.

Parameters:

- **name** - the process name (default is *all processes*);
- **user** - the user name (default is *all users*);
- **mode** - possible values: *avg*, *max*, *min*, or *sum* (default);
- **cmdline** - filter by command line (it is a regular **expression**);
- **memtype** - the **type of memory** used by process

Comments:

- The memtype parameter is supported only on Linux, FreeBSD, Solaris⁶, AIX;

- When several processes use shared memory, the sum of memory used by processes may result in large, unrealistic values.

See [notes](#) on selecting processes with name and cmdline parameters (Linux-specific).

When this item is invoked from the command line and contains a command line parameter (e.g. using the agent test mode: `zabbix_agentd -t proc.mem[, , ,apache2]`), one extra process will be counted, as the agent will count itself.

Examples:

```
proc.mem[,root] #the memory used by all processes running under the "root" user
proc.mem[zabbix_server,zabbix] #the memory used by all zabbix_server processes running under the zabbix user
proc.mem[,oracle,max,oracleZABBIX] #the memory used by the most memory-hungry process running under Oracle
proc.num[<name>,<user>,<state>,<cmdline>,<zone>]
```

 The number of processes.
 Return value: *Integer*.
 Supported platforms: Linux, FreeBSD, Solaris⁶, HP-UX, AIX, OpenBSD, NetBSD.

Parameters:

- **name** - the process name (default is *all processes*);
- **user** - the user name (default is *all users*);
- **state** - possible values:
all (default),
disk - uninterruptible sleep,
run - running,
sleep - interruptible sleep,
trace - stopped,
zomb - zombie;
- **cmdline** - filter by command line (it is a regular [expression](#));
- **zone** - the target zone: *current* (default), or *all*. This parameter is supported on Solaris only.

Comments:

- The *disk* and *trace* state parameters are supported only on Linux, FreeBSD, OpenBSD, NetBSD;
- When this item is invoked from the command line and contains a command line parameter (e.g. using the agent test mode: `zabbix_agentd -t proc.num[, , ,apache2]`), one extra process will be counted, as the agent will count itself;
- When setting the zone parameter to *current* (or default) in case the agent has been compiled on a Solaris without zone support, but running on a newer Solaris where zones are supported, then the agent will return NOTSUPPORTED (the agent cannot limit results to only the current zone). However, *all* is supported in this case.
- See [notes](#) on selecting processes with name and cmdline parameters (Linux-specific).

Examples:

```
proc.num[,mysql] #the number of processes running under the mysql user
proc.num[apache2,www-data] #the number of apache2 processes running under the www-data user
proc.num[,oracle,sleep,oracleZABBIX] #the number of processes in sleep state running under Oracle having o
sensor[device,sensor,<mode>]
```

 Hardware sensor reading.
 Return value: *Float*.
 Supported platforms: Linux, OpenBSD.

Parameters:

- **device** - the device name, can be a regular expression if mode is omitted;
- **sensor** - the sensor name, can be a regular expression if mode is omitted;
- **mode** - possible values: *avg*, *max*, or *min* (if this parameter is omitted, device and sensor are treated verbatim).

Comments:

- Reads `/proc/sys/dev/sensors` on Linux 2.4;
- Reads `/sys/class/hwmon` on Linux 2.6+. See a more detailed description of [sensor](#) item on Linux.
- Reads the `hw.sensors` MIB on OpenBSD.

Examples:

```
sensor[w83781d-i2c-0-2d,temp1]
sensor[cpu0,temp0] #the temperature of one CPU
sensor["cpu[0-2]$",temp,avg] #the average temperature of the first three CPUs
system.boottime
```

 The system boot time.
 Return value: *Integer (Unix timestamp)*.
 Supported platforms: Linux, FreeBSD, Solaris, MacOS X, OpenBSD, NetBSD.

system.cpu.discovery

 The list of detected CPUs/CPU cores. Used for low-level discovery.
 Return value: *JSON object*.
 See [supported platforms](#).

system.cpu.intr

 The device interrupts.
 Return value: *Integer*.
 Supported platforms: Linux, FreeBSD, Solaris, AIX, OpenBSD, NetBSD.

`system.cpu.load[<cpu>,<mode>]`

 The **CPU load**.
 Return value: *Float*.
 See **supported platforms**.

Parameters:

- **cpu** - possible values: *all* (default) or *percpu* (the total load divided by online CPU count);
- **mode** - possible values: *avg1* (one-minute average, default), *avg5*, or *avg15*.

Example:

```
system.cpu.load[,avg5]
```

```
system.cpu.num[<type>]
```

 The number of CPUs.
 Return value: *Integer*.
 Supported platforms: Linux, FreeBSD, Solaris, HP-UX, AIX, MacOS X, OpenBSD, NetBSD.

Parameter:

- **type** - possible values: *online* (default) or *max*

The *max* type parameter is supported only on Linux, FreeBSD, Solaris, MacOS X.

Example:

```
system.cpu.num
```

```
system.cpu.switches
```

 The count of context switches.
 Return value: *Integer*.
 Supported platforms: Linux, FreeBSD, Solaris, AIX, OpenBSD, NetBSD.

```
system.cpu.util[<cpu>,<type>,<mode>,<logical or physical>]
```

 The CPU utilization percentage.
 Return value: *Float*.
 Supported platforms: Linux, FreeBSD, Solaris, HP-UX, AIX, OpenBSD, NetBSD.

Parameters:

- **cpu** - *<CPU number>* or *all* (default);
- **type** - possible values: *user* (default), *idle*, *nice*, *system*, *iowait*, *interrupt*, *softirq*, *steal*, *spin* (on OpenBSD), *guest* (on Linux kernels 2.6.24 and above), or *guest_nice* (on Linux kernels 2.6.33 and above);
- **mode** - possible values: *avg1* (one-minute average, default), *avg5*, or *avg15*;
- **logical or physical** - possible values: *logical* (default) or *physical*. This parameter is supported on AIX only.

Comments:

- The *nice* type parameter is supported only on Linux, FreeBSD, HP-UX, OpenBSD, NetBSD.
- The *iowait* type parameter is supported only on Linux 2.6 and later, Solaris, AIX.
- The *interrupt* type parameter is supported only on Linux 2.6 and later, FreeBSD, OpenBSD.
- The *softirq*, *steal*, *guest*, *guest_nice* type parameters are supported only on Linux 2.6 and later.
- The *avg5* and *avg15* mode parameters are supported on Linux, FreeBSD, Solaris, HP-UX, AIX, OpenBSD, NetBSD.

Example:

```
system.cpu.util[0,user,avg5]
```

```
system.hostname[<type>,<transform>]
```

 The system host name.
 Return value: *String*.
 See **supported platforms**.

Parameters:

- **type** - possible values: *netbios* (default on Windows), *host* (default on Linux), *shorthost* (returns part of the hostname before the first dot, a full string for names without dots), *fqdn* (returns Fully Qualified Domain Name);
- **transform** - possible values: *none* (default) or *lower* (convert to lowercase).

The value is acquired by taking `nodename` from the `uname()` system API output.

Examples of returned values:

```
system.hostname → linux-w7x1
```

```
system.hostname → example.com
```

```
system.hostname[shorthost] → example
```

```
system.hostname → WIN-SERV2008-I6
```



```
system.hostname[host] → Win-Serv2008-I6LonG
system.hostname[host,lower] → win-serv2008-i6long
system.hostname[fqdn,lower] → blog.zabbix.com
```

```
system.hw.chassis[<info>]
```

 The chassis information.
 Return value: *String*.
 Supported platforms: Linux.

Parameter:

- **info** - possible values: *full* (default), *model*, *serial*, *type*, or *vendor*

Comments:

- This item key depends on the availability of the **SMBIOS** table;
- It will try to read the DMI table from sysfs, if sysfs access fails then try reading directly from memory;
- **Root permissions** are required because the value is acquired by reading from sysfs or memory.

Example:

```
system.hw.chassis[full] → Hewlett-Packard HP Pro 3010 Small Form Factor PC CZXXXXXXXX Desktop
```

```
system.hw.cpu[<cpu>,<info>]
```

 The CPU information.
 Return value: *String* or *Integer*.
 Supported platforms: Linux.

Parameters:

- **cpu** - *<CPU number>* or *all* (default);
- **info** - possible values: *full* (default), *curfreq*, *maxfreq*, *model* or *vendor*.

Comments:

- Gathers info from `/proc/cpuinfo` and `/sys/devices/system/cpu/[cpunum]/cpufreq/cpuinfo_max_freq`;
- If a CPU number and *curfreq* or *maxfreq* is specified, a numeric value is returned (Hz).

Example:

```
system.hw.cpu[0,vendor] → AuthenticAMD
```

```
system.hw.devices[<type>]
```

 The listing of PCI or USB devices.
 Return value: *Text*.
 Supported platforms: Linux.

Parameter:

- **type** - *pci* (default) or *usb*

Returns the output of either the `lspci` or `lsusb` utility (executed without any parameters).

Example:

```
system.hw.devices → 00:00.0 Host bridge: Advanced Micro Devices [AMD] RS780 Host Bridge
```

```
system.hw.macaddr[<interface>,<format>]
```

 The listing of MAC addresses.
 Return value: *String*.
 Supported platforms: Linux.

Parameters:

- **interface** - *all* (default) or a regular **expression**;
- **format** - *full* (default) or *short*

Comments:

- Lists MAC addresses of the interfaces whose name matches the given **interface regular expression** (*all* lists for all interfaces);
- If **format** is specified as *short*, interface names and identical MAC addresses are not listed.

Example:

```
system.hw.macaddr["eth0$",full] → [eth0] 00:11:22:33:44:55
```

```
system.localtime[<type>]
```

 The system time.
 Return value: *Integer* - with type as *utc*; *String* - with type as *local*.
 See **supported platforms**.

Parameters:

- **type** - possible values: *utc* - (default) the time since the Epoch (00:00:00 UTC, January 1, 1970), measured in seconds or *local* - the time in the 'yyyy-mm-dd, hh:mm:ss.nnn, +hh:mm' format

Must be used as a **passive check** only.

Example:

```
system.localtime[local] #create an item using this key and then use it to display the host time in the *CL
system.run[command,<mode>]
```

 Run the specified command on the host.
 Return value: *Text* result of the command or 1 - with mode as *nowait* (regardless of the command result).
 See **supported platforms**.

Parameters:

- **command** - command for execution;

- **mode** - possible values: *wait* - wait end of execution (default) or *nowait* - do not wait.

Comments:

- This item is disabled by default. Learn how to **enable them**;
- The return value of the item is a standard output together with a standard error produced by the command. **Exit code checking** is not performed;
- To be processed correctly, the return value of the command must be of *text* data type. An empty result is also allowed;
- The return value is limited to 16MB (including trailing whitespace that is truncated); **database limits** also apply;
- See also: **Command execution**.

Example:

```
system.run[ls -l /] #return a detailed file list of the root directory
system.stat[resource,<type>]
```

 The system statistics.
 Return value: *Integer* or *float*.
 Supported platforms: AIX.

Parameters:

- **ent** - the number of processor units this partition is entitled to receive (float);
- **kthr,<type>** - information about kernel thread states:
r - average number of runnable kernel threads (float)
b - average number of kernel threads placed in the Virtual Memory Manager wait queue (float)
- **memory,<type>** - information about the usage of virtual and real memory:
avm - active virtual pages (integer)
fre - size of the free list (integer)
- **page,<type>** - information about page faults and paging activity:
fi - file page-ins per second (float)
fo - file page-outs per second (float)
pi - pages paged in from paging space (float)
po - pages paged out to paging space (float)
fr - pages freed (page replacement) (float)
sr - pages scanned by page-replacement algorithm (float)
- **faults,<type>** - trap and interrupt rate:
in - device interrupts (float)
sy - system calls (float)
cs - kernel thread context switches (float)
- **cpu,<type>** - breakdown of percentage usage of processor time:
us - user time (float)
sy - system time (float)
id - idle time (float)
wa - idle time during which the system had outstanding disk/NFS I/O request(s) (float)
pc - number of physical processors consumed (float)
ec - the percentage of entitled capacity consumed (float)
lbusy - indicates the percentage of logical processor(s) utilization that occurred while executing at the user and system level (float)
app - indicates the available physical processors in the shared pool (float)
- **disk,<type>** - disk statistics:
bps - indicates the amount of data transferred (read or written) to the drive in bytes per second (integer)
tps - indicates the number of transfers per second that were issued to the physical disk/tape (float)

Comments:

- Take note of the following limitations in these items:
 `system.stat[cpu,app]` - supported only on AIX LPAR of type "Shared"
 `system.stat[cpu,ec]` - supported on AIX LPAR of type "Shared" and "Dedicated" ("Dedicated" always returns 100 (percent))
 `system.stat[cpu,lbusy]` - supported only on AIX LPAR of type "Shared"
 `system.stat[cpu,pc]` - supported on AIX LPAR of type "Shared" and "Dedicated"
 `system.stat[ent]` - supported on AIX LPAR of type "Shared" and "Dedicated"

```
system.sw.arch
```

 The software architecture information.
 Return value: *String*.
 See **supported platforms**.

The info is acquired from the `uname()` function.

Example:

```
system.sw.arch → i686
```

system.sw.os[<info>]

 The operating system information.
 Return value: *String*.
 Supported platforms: Linux, Windows.

Parameter:

- **info** - possible values: *full* (default), *short*, or *name*

The info is acquired from (note that not all files and options are present in all distributions):

- */proc/version* (*full*) on Linux;
- */proc/version_signature* (*short*) on Linux;
- the PRETTY_NAME parameter from */etc/os-release* on Linux-systems supporting it or */etc/issue.net* (*name*);
- the HKLM\SOFTWARE\Microsoft\Windows NT\CurrentVersion registry key on Windows.

Examples:

system.sw.os[short] → Ubuntu 2.6.35-28.50-generic 2.6.35.11

system.sw.os[full] → [s|Windows 10 Enterprise 22621.1.asd64fre.ni_release.220506-1250 Build 22621.963]

system.sw.os.get

 Detailed information about the operating system (version, type, distribution name, minor and major version, etc).
 Return value: *JSON object*.
 Supported platforms: Linux, Windows.

system.sw.packages[<regexp>,<manager>,<format>]

 The listing of installed packages.
 Return value: *Text*.
 Supported platforms: Linux.

Parameters:

- **regexp** - *all* (default) or a regular **expression**;
- **manager** - *all* (default) or a package manager;
- **format** - *full* (default) or *short*.

Comments:

- Lists (alphabetically) installed packages whose name matches the given regular **expression** (*all* lists them all);
- Supported package managers (executed command):
dpkg (dpkg --get-selections)
pkgtool (ls /var/log/packages)
rpm (rpm -qa)
pacman (pacman -Q)
portage
- If **format** is specified as *full*, packages are grouped by package managers (each manager on a separate line beginning with its name in square brackets);
- If **format** is specified as *short*, packages are not grouped and are listed on a single line.

Example:

system.sw.packages[mini,dpkg,short] → python-minimal, python2.6-minimal, ubuntu-minimal

system.sw.packages.get[<regexp>,<manager>]

 A detailed listing of installed packages.
 Return value: *JSON object*.
 Supported platforms: Linux.

Parameters:

- **regexp** - *all* (default) or a regular **expression**;
- **manager** - *all* (default) or a package manager (possible values: *rpm*, *dpkg*, *pkgtool*, *pacman*, or *portage*).

Comments:

- Returns unformatted JSON with the installed packages whose name matches the given regular expression;
- The output is an array of objects each containing the following keys: name, manager, version, size, architecture, buildtime and installtime (see **more details**).

system.swap.in[<device>,<type>]

 The swap-in (from device into memory) statistics.
 Return value: *Integer*.
 Supported platforms: Linux, FreeBSD, OpenBSD.

Parameters:

- **device** - specify the device used for swapping (Linux only) or *all* (default);
- **type** - possible values: *count* (number of swapins, default on non-Linux platforms), *sectors* (sectors swapped in), or *pages* (pages swapped in, default on Linux).

Comments:

- The source of this information is: `/proc/swaps`, `/proc/partitions`, `/proc/stat` (Linux 2.4) `/proc/swaps`, `/proc/diskstats`, `/proc/vmstat` (Linux 2.6)
- Note that *pages* will only work if device was not specified;
- The *sectors* type parameter is supported only on Linux.

Example:

```
system.swap.in[,pages]
```

```
system.swap.out[<device>,<type>]
```

`
` The swap-out (from memory onto device) statistics. `
` Return value: *Integer*. `
` **Supported platforms:** Linux, FreeBSD, OpenBSD.

Parameters:

- **device** - specify the device used for swapping (Linux only) or *all* (default);
- **type** - possible values: *count* (number of swapouts, default on non-Linux platforms), *sectors* (sectors swapped out), or *pages* (pages swapped out, default on Linux).

Comments:

- The source of this information is: `/proc/swaps`, `/proc/partitions`, `/proc/stat` (Linux 2.4) `/proc/swaps`, `/proc/diskstats`, `/proc/vmstat` (Linux 2.6)
- Note that *pages* will only work if device was not specified;
- The *sectors* type parameter is supported only on Linux.

Example:

```
system.swap.out[,pages]
```

```
system.swap.size[<device>,<type>]
```

`
` The swap space size in bytes or in percentage from total. `
` Return value: *Integer* - for bytes; *Float* - for percentage. `
` **Supported platforms:** Linux, FreeBSD, Solaris, AIX, OpenBSD.

Parameters:

- **device** - specify the device used for swapping (FreeBSD only) or *all* (default);
- **type** - possible values: *free* (free swap space, default), *pfree* (free swap space, in percent), *used* (used swap space, in percent), *total* (total swap space), or *used* (used swap space).

Comments:

- Note that *pfree*, *used* are not supported on Windows if swap size is 0;
- If device is not specified Zabbix agent will only take into account swap devices (files), the physical memory will be ignored. For example, on Solaris systems the `swap -s` command includes a portion of physical memory and swap devices (unlike `swap -l`).

Example:

```
system.swap.size[,pfree] → free swap space percentage
```

```
system.uname
```

`
` Identification of the system. `
` Return value: *String*. `
` See **supported platforms**.

Comments:

- On UNIX the value for this item is obtained with the `uname()` system call;
- On Windows the item returns the OS architecture, whereas on UNIX it returns the CPU architecture.

Examples:

```
system.uname → FreeBSD localhost 4.2-RELEASE FreeBSD 4.2-RELEASE #0: Mon Nov i386
```

```
system.uname → Windows ZABBIX-WIN 6.0.6001 Microsoft® Windows Server® 2008 Standard Service Pack 1 x86
```

```
system.uptime
```

`
` The system uptime in seconds. `
` Return value: *Integer*. `
` **Supported platforms:** Linux, FreeBSD, Solaris, AIX, MacOS X, OpenBSD, NetBSD.

In **item configuration**, use **s** or **uptime** units to get readable values.

```
system.users.num
```

`
` The number of users logged in. `
` Return value: *Integer*. `
` See **supported platforms**.

The **who** command is used on the agent side to obtain the value.

`vfs.dev.discovery`

 The list of block devices and their type. Used for low-level discovery.
 Return value: *JSON object*.
 Supported platforms: Linux.

`vfs.dev.read[<device>,<type>,<mode>]`

 The disk read statistics.
 Return value: *Integer* - with type in *sectors, operations, bytes*; *Float* - with type in *sps, ops, bps*.
 Supported platforms: Linux, FreeBSD, Solaris, AIX, OpenBSD.

Parameters:

- **device** - disk device (default is *all* ³);
- **type** - possible values: *sectors, operations, bytes, sps, ops, or bps* (*sps, ops, bps* stand for: sectors, operations, bytes per second, respectively);
- **mode** - possible values: *avg1* (one-minute average, default), *avg5*, or *avg15*. This parameter is supported only with type in: *sps, ops, bps*.

Comments:

- If using an update interval of three hours or more ², this item will always return '0';
- The *sectors* and *sps* type parameters are supported only on Linux;
- The *ops* type parameter is supported only on Linux and FreeBSD;
- The *bps* type parameter is supported only on FreeBSD;
- The *bytes* type parameter is supported only on FreeBSD, Solaris, AIX, OpenBSD;
- The *mode* parameter is supported only on Linux, FreeBSD;
- You may use relative device names (for example, *sda*) as well as an optional */dev/* prefix (for example, */dev/sda*);
- LVM logical volumes are supported;
- The default values of 'type' parameter for different OSes:
AIX - *operations*
FreeBSD - *bps*
Linux - *sps*
OpenBSD - *operations*
Solaris - *bytes*
- *sps, ops* and *bps* on supported platforms is limited to 1024 devices (1023 individual and one for *all*).

Example:

`vfs.dev.read[,operations]`

`vfs.dev.write[<device>,<type>,<mode>]`

 The disk write statistics.
 Return value: *Integer* - with type in *sectors, operations, bytes*; *Float* - with type in *sps, ops, bps*.
 Supported platforms: Linux, FreeBSD, Solaris, AIX, OpenBSD.

Parameters:

- **device** - disk device (default is *all* ³);
- **type** - possible values: *sectors, operations, bytes, sps, ops, or bps* (*sps, ops, bps* stand for: sectors, operations, bytes per second, respectively);
- **mode** - possible values: *avg1* (one-minute average, default), *avg5*, or *avg15*. This parameter is supported only with type in: *sps, ops, bps*.

Comments:

- If using an update interval of three hours or more ², this item will always return '0';
- The *sectors* and *sps* type parameters are supported only on Linux;
- The *ops* type parameter is supported only on Linux and FreeBSD;
- The *bps* type parameter is supported only on FreeBSD;
- The *bytes* type parameter is supported only on FreeBSD, Solaris, AIX, OpenBSD;
- The *mode* parameter is supported only on Linux, FreeBSD;
- You may use relative device names (for example, *sda*) as well as an optional */dev/* prefix (for example, */dev/sda*);
- LVM logical volumes are supported;
- The default values of 'type' parameter for different OSes:
AIX - *operations*
FreeBSD - *bps*
Linux - *sps*
OpenBSD - *operations*
Solaris - *bytes*
- *sps, ops* and *bps* on supported platforms is limited to 1024 devices (1023 individual and one for *all*).

Example:

`vfs.dir.write[,operations]`

`vfs.dir.count[dir,<regex incl>,<regex excl>,<types incl>,<types excl>,<max depth>,<min size>,<max size>,<min age>,<max age>,<regex excl dir>]`

 The directory entry count.
 Return value: *Integer*.
 See **supported platforms**.

Parameters:

- **dir** - the absolute path to directory;
- **regex incl** - a regular **expression** describing the name pattern of the entity (file, directory, symbolic link) to include; include all if empty (default value);
- **regex excl** - a regular **expression** describing the name pattern of the entity (file, directory, symbolic link) to exclude; don't exclude any if empty (default value);
- **types incl** - directory entry types to count, possible values: *file* - regular file, *dir* - subdirectory, *sym* - symbolic link, *sock* - socket, *bdev* - block device, *cdev* - character device, *fifo* - FIFO, *dev* - synonymous with "bdev,cdev", *all* - all types (default), i.e. "file,dir,sym,sock,bdev,cdev,fifo". Multiple types must be separated with comma and quoted.
- **types excl** - directory entry types (see `types incl`) to NOT count. If some entry type is in both `types incl` and `types excl`, directory entries of this type are NOT counted.
- **max depth** - the maximum depth of subdirectories to traverse:

-1 (default) - unlimited,
0 - no descending into subdirectories.
- **min size** - the minimum size (in bytes) for file to be counted. Smaller files will not be counted. **Memory suffixes** can be used.
- **max size** - the maximum size (in bytes) for file to be counted. Larger files will not be counted. **Memory suffixes** can be used.
- **min age** - the minimum age (in seconds) of directory entry to be counted. More recent entries will not be counted. **Time suffixes** can be used.
- **max age** - the maximum age (in seconds) of directory entry to be counted. Entries so old and older will not be counted (modification time). **Time suffixes** can be used.
- **regex excl dir** - a regular **expression** describing the name pattern of the directory to exclude. All content of the directory will be excluded (in contrast to `regex_excl`)

Comments:

- Environment variables, e.g. %APP_HOME%, \$HOME and %TEMP% are not supported;
- Pseudo-directories "." and ".." are never counted;
- Symbolic links are never followed for directory traversal;
- Both `regex incl` and `regex excl` are being applied to files and directories when calculating the entry count, but are ignored when picking subdirectories to traverse (if `regex incl` is "(?i)^.\.zip\$" and `max depth` is not set, then all subdirectories will be traversed, but only the files of type zip will be counted).
- The execution time is limited by the timeout value in agent **configuration** (3 sec). Since large directory traversal may take longer than that, no data will be returned and the item will turn unsupported. Partial count will not be returned.
- When filtering by size, only regular files have meaningful sizes. Under Linux and BSD, directories also have non-zero sizes (a few Kb typically). Devices have zero sizes, e.g. the size of `/dev/sda1` does not reflect the respective partition size. Therefore, when using `<min_size>` and `<max_size>`, it is advisable to specify `<types_incl>` as "file", to avoid surprises.

Examples:

```
vfs.dir.count[/dev] #monitors the number of devices in /dev (Linux)
vfs.dir.count["C:\Users\ADMINI~1\AppData\Local\Temp"] #monitors the number of files in a temporary directory
vfs.dir.get[dir,<regex incl>,<regex excl>,<types incl>,<types excl>,<max depth>,<min size>,<max size>,<min age>,<max age>,<regex excl dir>]
```

 The directory entry list.
 Return value: *JSON object*.
 See **supported platforms**.

Parameters:

- **dir** - the absolute path to directory;
- **regex incl** - a regular **expression** describing the name pattern of the entity (file, directory, symbolic link) to include; include all if empty (default value);
- **regex excl** - a regular **expression** describing the name pattern of the entity (file, directory, symbolic link) to exclude; don't exclude any if empty (default value);
- **types incl** - directory entry types to list, possible values: *file* - regular file, *dir* - subdirectory, *sym* - symbolic link, *sock* - socket, *bdev* - block device, *cdev* - character device, *fifo* - FIFO, *dev* - synonymous with "bdev,cdev", *all* - all types (default), i.e. "file,dir,sym,sock,bdev,cdev,fifo". Multiple types must be separated with comma and quoted.
- **types excl** - directory entry types (see `types incl`) to NOT list. If some entry type is in both `types incl` and `types excl`, directory entries of this type are NOT listed.
- **max depth** - the maximum depth of subdirectories to traverse:

-1 (default) - unlimited,
0 - no descending into subdirectories.
- **min size** - the minimum size (in bytes) for file to be listed. Smaller files will not be listed. **Memory suffixes** can be used.
- **max size** - the maximum size (in bytes) for file to be listed. Larger files will not be listed. **Memory suffixes** can be used.
- **min age** - the minimum age (in seconds) of directory entry to be listed. More recent entries will not be listed. **Time suffixes** can be used.
- **max age** - the maximum age (in seconds) of directory entry to be listed. Entries so old and older will not be listed (modification time). **Time suffixes** can be used.

- **regex excl dir** - a regular **expression** describing the name pattern of the directory to exclude. All content of the directory will be excluded (in contrast to `regex excl`)

Comments:

- Environment variables, e.g. `%APP_HOME%`, `$HOME` and `%TEMP%` are not supported;
- Pseudo-directories `"."` and `".."` are never listed;
- Symbolic links are never followed for directory traversal;
- Both `regex incl` and `regex excl` are being applied to files and directories when generating the entry list, but are ignored when picking subdirectories to traverse (if `regex incl` is `"(?:i)^.+\.zip$"` and `max depth` is not set, then all subdirectories will be traversed, but only the files of type `zip` will be counted).
- The execution time is limited by the timeout value in agent **configuration**. Since large directory traversal may take longer than that, no data will be returned and the item will turn unsupported. Partial list will not be returned.
- When filtering by size, only regular files have meaningful sizes. Under Linux and BSD, directories also have non-zero sizes (a few Kb typically). Devices have zero sizes, e.g. the size of `/dev/sda1` does not reflect the respective partition size. Therefore, when using `min size` and `max size`, it is advisable to specify `types incl` as `"file"`, to avoid surprises.

Examples:

```
vfs.dir.get[/dev] #retrieves the device list in /dev (Linux)
vfs.dir.get["C:\Users\ADMINI~1\AppData\Local\Temp"] #retrieves the file list in a temporary directory
vfs.dir.size[dir,<regex incl>,<regex excl>,<mode>,<max depth>,<regex excl dir>]
```

 The directory size (in bytes).
 Return value: *Integer*.
 Supported platforms: Linux. The item may work on other UNIX-like platforms.

Parameters:

- **dir** - the absolute path to directory;
- **regex incl** - a regular **expression** describing the name pattern of the entity (file, directory, symbolic link) to include; include all if empty (default value);
- **regex excl** - a regular **expression** describing the name pattern of the entity (file, directory, symbolic link) to exclude; don't exclude any if empty (default value);
- **mode** - possible values: *apparent* (default) - gets apparent file sizes rather than disk usage (acts as `du -sb dir`), *disk* - gets disk usage (acts as `du -s -B1 dir`). Unlike the `du` command, the `vfs.dir.size` item takes hidden files in account when calculating the directory size (acts as `du -sb .[^.]* * within dir`).
- **max depth** - the maximum depth of subdirectories to traverse: **-1** (default) - unlimited, **0** - no descending into subdirectories.
- **regex excl dir** - a regular **expression** describing the name pattern of the directory to exclude. All content of the directory will be excluded (in contrast to `regex excl`)

Comments:

- Only directories with at least the read permission for `zabbix` user are calculated. For directories with read permission only, the size of the directory itself is calculated. Directories with read & execute permissions are calculated including contents.
- With large directories or slow drives this item may time out due to the Timeout setting in **agent** and **server/proxy** configuration files. Increase the timeout values as necessary.
- The file size limit depends on **large file support**.

Examples:

```
vfs.dir.size[/tmp,log] #calculates the size of all files in /tmp containing 'log' in their names
vfs.dir.size[/tmp,log,^.+\.old$] #calculates the size of all files in /tmp containing 'log' in their names
vfs.file.cksum[file,<mode>]
```

 The file checksum, calculated by the UNIX `cksum` algorithm.
 Return value: *Integer* - with mode as *crc32*, *String* - with mode as *md5*, *sha256*.
 See **supported platforms**.

Parameters:

- **file** - the full path to file;
- **mode** - *crc32* (default), *md5*, or *sha256*.

The file size limit depends on **large file support**.

Example:

```
vfs.file.cksum[/etc/passwd]
```

Examples of returned values (crc32/md5/sha256 respectively):

675436101
9845acf68b73991eb7fd7ee0ded23c44
ae67546e4aac995e5c921042d0cf0f1f7147703aa42bfbfb65404b30f238f2dc

`vfs.file.contents[file,<encoding>]`

 Retrieving the contents of a file⁷.
 Return value: *Text*.
 See [supported platforms](#).

Parameters:

- **file** - the full path to file;
- **encoding** - the code page [identifier](#).

Comments:

- The return value is limited to 16MB (including trailing whitespace that is truncated); [database limits](#) also apply;
- An empty string is returned if the file is empty or contains LF/CR characters only;
- The byte order mark (BOM) is excluded from the output.

Example:

```
vfs.file.contents[/etc/passwd]
```

```
vfs.file.exists[file,<types incl>,<types excl>]
```

 Checks if the file exists.
 Return value: 0 - not found; 1 - file of the specified type exists.
 See [supported platforms](#).

Parameters:

- **file** - the full path to file;
- **types incl** - the list of file types to include, possible values: *file* (regular file, default (if `types_excl` is not set)), *dir* (directory), *sym* (symbolic link), *sock* (socket), *bdev* (block device), *cdev* (character device), *fifo* (FIFO), *dev* (synonymous with "bdev,cdev"), *all* (all mentioned types, default if `types_excl` is set).
- **types excl** - the list of file types to exclude, see `types_incl` for possible values (by default no types are excluded)

Comments:

- Multiple types must be separated with a comma and the entire set enclosed in quotes "";
- If the same type is in both `<types_incl>` and `<types_excl>`, files of this type are excluded;
- The file size limit depends on [large file support](#).

Examples:

```
vfs.file.exists[/tmp/application.pid]
```

```
vfs.file.exists[/tmp/application.pid,"file,dir,sym"]
```

```
vfs.file.exists[/tmp/application_dir,dir]
```

```
vfs.file.get[file]
```

 Returns information about a file.
 Return value: *JSON object*.
 See [supported platforms](#).

Parameter:

- **file** - the full path to file

Comments:

- Supported file types on UNIX-like systems: regular file, directory, symbolic link, socket, block device, character device, FIFO.
- The file size limit depends on [large file support](#).

Example:

```
vfs.file.get[/etc/passwd] #return a JSON with information about the /etc/passwd file (type, user, permission)
```

```
vfs.file.md5sum[file]
```

 The MD5 checksum of file.
 Return value: Character string (MD5 hash of the file).
 See [supported platforms](#).

Parameter:

- **file** - the full path to file

The file size limit depends on [large file support](#).

Example:

```
vfs.file.md5sum[/usr/local/etc/zabbix_agentd.conf]
```

Example of returned value:

b5052decb577e0fffd622d6ddc017e82

`vfs.file.owner[file,<ownertype>,<resulttype>]`

 Retrieves the owner of a file.
 Return value: *String*.
 See [supported platforms](#).

Parameters:

- **file** - the full path to file;
- **ownertype** - *user* (default) or *group* (Unix only);
- **resulttype** - *name* (default) or *id*; for *id* - return uid/gid on Unix, SID on Windows.

The file size limit depends on [large file support](#).

Examples:

```
vfs.file.owner[/tmp/zabbix_server.log] #return the file owner of /tmp/zabbix_server.log
vfs.file.owner[/tmp/zabbix_server.log,,id] #return the file owner ID of /tmp/zabbix_server.log
```

`vfs.file.permissions[file]`

 Return a 4-digit string containing the octal number with UNIX permissions.
 Return value: *String*.
 [Supported platforms](#): Linux. The item may work on other UNIX-like platforms.

Parameters:

- **file** - the full path to file

The file size limit depends on [large file support](#).

Example:

```
vfs.file.permissions[/etc/passwd] #return permissions of /etc/passwd, for example, '0644'
```

`vfs.file.regexp[file,regexp,<encoding>,<start line>,<end line>,<output>]`

 Retrieve a string in the file⁷.
 Return value: The line containing the matched string, or as specified by the optional output parameter.
 See [supported platforms](#).

Parameters:

- **file** - the full path to file;
- **regexp** - a regular [expression](#) describing the required pattern;
- **encoding** - the code page [identifier](#);
- **start line** - the number of the first line to search (first line of file by default);
- **end line** - the number of the last line to search (last line of file by default);
- **output** - an optional output formatting template. The `\0` escape sequence is replaced with the matched part of text (from the first character where match begins until the character where match ends) while an `\N` (where N=1...9) escape sequence is replaced with Nth matched group (or an empty string if the N exceeds the number of captured groups).

Comments:

- The file size limit depends on [large file support](#).
- Only the first matching line is returned;
- An empty string is returned if no line matched the expression;
- The byte order mark (BOM) is excluded from the output;
- Content extraction using the output parameter takes place on the agent.

Examples:

```
vfs.file.regexp[/etc/passwd,zabbix]
vfs.file.regexp[/path/to/some/file,"([0-9]+)$",,3,5,\1]
vfs.file.regexp[/etc/passwd,"^zabbix: :([0-9]+)",,,\1] → getting the ID of user *zabbix*
```

`vfs.file.regmatch[file,regexp,<encoding>,<start line>,<end line>]`

 Find a string in the file⁷.
 Return values: 0 - match not found; 1 - found.
 See [supported platforms](#).

Parameters:

- **file** - the full path to file;
- **regexp** - a regular [expression](#) describing the required pattern;
- **encoding** - the code page [identifier](#);
- **start line** - the number of the first line to search (first line of file by default);
- **end line** - the number of the last line to search (last line of file by default).

Comments:

- The file size limit depends on [large file support](#).
- The byte order mark (BOM) is ignored.

Example:

```
vfs.file.regmatch[/var/log/app.log,error]
```

```
vfs.file.size[file,<mode>]
```

 The file size (in bytes).
 Return value: *Integer*.
 See [supported platforms](#).

Parameters:

- **file** - the full path to file;
- **mode** - possible values: *bytes* (default) or *lines* (empty lines are counted, too).

Comments:

- The file must have read permissions for user *zabbix*;
- The file size limit depends on [large file support](#).

Example:

```
vfs.file.size[/var/log/syslog]
```

```
vfs.file.time[file,<mode>]
```

 The file time information.
 Return value: *Integer* (Unix timestamp).
 See [supported platforms](#).

Parameters:

- **file** - the full path to file;
- **mode** - possible values:
modify (default) - the last time of modifying file content,
access - the last time of reading file,
change - the last time of changing file properties

The file size limit depends on [large file support](#).

Example:

```
vfs.file.time[/etc/passwd,modify]
```

```
vfs.fs.discovery
```

 The list of mounted filesystems with their type and mount options. Used for low-level discovery.
 Return value: *JSON object*.
 [Supported platforms](#): Linux, FreeBSD, Solaris, HP-UX, AIX, MacOS X, OpenBSD, NetBSD.

```
vfs.fs.get
```

 The list of mounted filesystems with their type, available disk space, inode statistics and mount options. Can be used for low-level discovery.
 Return value: *JSON object*.
 [Supported platforms](#): Linux, FreeBSD, Solaris, HP-UX, AIX, MacOS X, OpenBSD, NetBSD.

Comments:

- File systems with the inode count equal to zero, which can be the case for file systems with dynamic inodes (e.g. btrfs), are also reported;
- See also: [Discovery of mounted filesystems](#).

```
vfs.fs.inode[fs,<mode>]
```

 The number or percentage of inodes.
 Return value: *Integer* - for number; *Float* - for percentage.
 See [supported platforms](#).

Parameters:

- **fs** - the filesystem;
- **mode** - possible values: *total* (default), *free*, *used*, *pfree* (free, percentage), or *pusd* (used, percentage).

If the inode count equals zero, which can be the case for file systems with dynamic inodes (e.g. btrfs), the pfree/pused values will be reported as "100" and "0" respectively.

Example:

```
vfs.fs.inode[/,pfree]
```

`vfs.fs.size[fs,<mode>]`

 The disk space in bytes or in percentage from total.
 Return value: *Integer* - for bytes; *Float* - for percentage.
 See [supported platforms](#).

Parameters:

- **fs** - the filesystem;
- **mode** - possible values: *total* (default), *free*, *used*, *pfree* (free, percentage), or *pused* (used, percentage).

Comments:

- If the filesystem is not mounted, returns the size of a local filesystem where the mount point is located;
- The reserved space of a file system is taken into account and not included when using the *free* mode.

Example:

```
vfs.fs.size[/tmp,free]
```

```
vm.memory.size[<mode>]
```

 The memory size in bytes or in percentage from total.
 Return value: *Integer* - for bytes; *Float* - for percentage.
 See [supported platforms](#).

Parameter:

- **mode** - possible values: *total* (default), *active*, *anon*, *buffers*, *cached*, *exec*, *file*, *free*, *inactive*, *pinned*, *shared*, *slab*, *wired*, *used*, *pused* (used, percentage), *available*, or *pavailable* (available, percentage).

Comments:

- This item accepts three categories of parameters:
1) *total* - total amount of memory
2) platform-specific memory types: *active*, *anon*, *buffers*, *cached*, *exec*, *file*, *free*, *inactive*, *pinned*, *shared*, *slab*, *wired*
3) user-level estimates on how much memory is used and available: *used*, *pused*, *available*, *pavailable*
- The *active* mode parameter is supported only on FreeBSD, HP-UX, MacOS X, OpenBSD, NetBSD;
- The *anon*, *exec*, *file* mode parameters are supported only on NetBSD;
- The *buffers* mode parameter is supported only on Linux, FreeBSD, OpenBSD, NetBSD;
- The *cached* mode parameter is supported only on Linux, FreeBSD, AIX, OpenBSD, NetBSD;
- The *inactive*, *wired* mode parameters are supported only on FreeBSD, MacOS X, OpenBSD, NetBSD;
- The *pinned* mode parameter is supported only on AIX;
- The *shared* mode parameter is supported only on Linux 2.4, FreeBSD, OpenBSD, NetBSD;
- See also [additional details](#) for this item.

Example:

```
vm.memory.size[pavailable]
```

```
web.page.get[host,<path>,<port>]
```

 Get the content of a web page.
 Return value: Web page source as text (including headers).
 See [supported platforms](#).

Parameters:

- **host** - the hostname or URL (as `scheme://host:port/path`, where only *host* is mandatory). Allowed URL schemes: *http*, *https*⁴. A missing scheme will be treated as *http*. If a URL is specified *path* and *port* must be empty. Specifying user name/password when connecting to servers that require authentication, for example: `http://user:password@www.example.com` is only possible with cURL support⁴. [Punycode](#) is supported in hostnames.
- **path** - the path to an HTML document (default is */*);
- **port** - the port number (default is 80 for HTTP)

Comments:

- This item turns unsupported if the resource specified in *host* does not exist or is unavailable;
- *host* can be a hostname, domain name, IPv4 or IPv6 address. But for IPv6 address Zabbix agent must be compiled with IPv6 support enabled.

Examples:

```
web.page.get[www.example.com,index.php,80]
```

```
web.page.get[https://www.example.com]
```

```
web.page.get[https://blog.example.com/?s=zabbix]
```

```
web.page.get[localhost:80]
```

```
web.page.get["[:1]/server-status"]
```

web.page.perf[host,<path>,<port>]

 The loading time of a full web page (in seconds).
 Return value: *Float*.
 See [supported platforms](#).

Parameters:

- **host** - the hostname or URL (as `scheme://host:port/path`, where only *host* is mandatory). Allowed URL schemes: *http*, *https*⁴. A missing scheme will be treated as *http*. If a URL is specified `path` and `port` must be empty. Specifying user name/password when connecting to servers that require authentication, for example: `http://user:password@www.example.com` is only possible with cURL support⁴. Punycode is supported in hostnames.
- **path** - the path to an HTML document (default is `/`);
- **port** - the port number (default is 80 for HTTP)

Comments:

- This item turns unsupported if the resource specified in `host` does not exist or is unavailable;
- `host` can be a hostname, domain name, IPv4 or IPv6 address. But for IPv6 address Zabbix agent must be compiled with IPv6 support enabled.

Examples:

```
web.page.perf[www.example.com,index.php,80]
```

```
web.page.perf[https://www.example.com]
```

```
web.page.regexp[host,<path>,<port>,regexp,<length>,<output>]
```

 Find a string on the web page.
 Return value: The matched string, or as specified by the optional output parameter.
 See [supported platforms](#).

Parameters:

- **host** - the hostname or URL (as `scheme://host:port/path`, where only *host* is mandatory). Allowed URL schemes: *http*, *https*⁴. A missing scheme will be treated as *http*. If a URL is specified `path` and `port` must be empty. Specifying user name/password when connecting to servers that require authentication, for example: `http://user:password@www.example.com` is only possible with cURL support⁴. Punycode is supported in hostnames.
- **path** - the path to an HTML document (default is `/`);
- **port** - the port number (default is 80 for HTTP)
- **regexp** - a regular [expression](#) describing the required pattern;
- **length** - the maximum number of characters to return;
- **output** - an optional output formatting template. The `\0` escape sequence is replaced with the matched part of text (from the first character where match begins until the character where match ends) while an `\N` (where `N=1...9`) escape sequence is replaced with Nth matched group (or an empty string if the `N` exceeds the number of captured groups).

Comments:

- This item turns unsupported if the resource specified in `host` does not exist or is unavailable;
- `host` can be a hostname, domain name, IPv4 or IPv6 address. But for IPv6 address Zabbix agent must be compiled with IPv6 support enabled.
- Content extraction using the `output` parameter takes place on the agent.

Examples:

```
web.page.regexp[www.example.com,index.php,80,OK,2]
```

```
web.page.regexp[https://www.example.com,, ,OK,2] |
```

```
agent.hostmetadata
```

 The agent host metadata.
 Return value: *String*.
 See [supported platforms](#).

Returns the value of `HostMetadata` or `HostMetadataItem` parameters, or empty string if none are defined.

```
agent.hostname
```

 The agent host name.
 Return value: *String*.
 See [supported platforms](#).

Returns:

- As passive check - the name of the first host listed in the `Hostname` parameter of the agent configuration file;
- As active check - the name of the current hostname.

```
agent.ping
```

 The agent availability check.
 Return value: Nothing - unavailable; 1 - available.
 See [supported platforms](#).

Use the `nodata()` trigger function to check for host unavailability.

agent.variant

 The variant of Zabbix agent (Zabbix agent or Zabbix agent 2).
 Return value: 1 - Zabbix agent; 2 - Zabbix agent 2.
 See [supported platforms](#).

agent.version

 The version of Zabbix agent.
 Return value: *String*.
 See [supported platforms](#).

Example of returned value:

6.0.3

zabbix.stats[<ip>,<port>]

 Returns a set of Zabbix server or proxy internal metrics remotely.
 Return value: *JSON object*.
 See [supported platforms](#).

Parameters:

- **ip** - the IP/DNS/network mask list of servers/proxies to be remotely queried (default is 127.0.0.1);
- **port** - the port of server/proxy to be remotely queried (default is 10051)

Comments:

- A selected set of internal metrics is returned by this item. For details, see [Remote monitoring of Zabbix stats](#);
- Note that the stats request will only be accepted from the addresses listed in the 'StatsAllowedIP' [server/proxy](#) parameter on the target instance.

zabbix.stats[<ip>,<port>,queue,<from>,<to>]

 Returns the number of monitored items in the queue which are delayed on Zabbix server or proxy remotely.
 Return value: *JSON object*.
 See [supported platforms](#).

Parameters:

- **ip** - the IP/DNS/network mask list of servers/proxies to be remotely queried (default is 127.0.0.1);
- **port** - the port of server/proxy to be remotely queried (default is 10051)
- **queue** - constant (to be used as is)
- **from** - delayed by at least (default is 6 seconds)
- **to** - delayed by at most (default is infinity)

Note that the stats request will only be accepted from the addresses listed in the 'StatsAllowedIP' [server/proxy](#) parameter on the target instance.

Footnotes

¹A Linux-specific note. Zabbix agent must have read-only access to filesystem */proc*. Kernel patches from www.grsecurity.org limit access rights of non-privileged users.

² `vfs.dev.read[]`, `vfs.dev.write[]`: Zabbix agent will terminate "stale" device connections if the item values are not accessed for more than 3 hours. This may happen if a system has devices with dynamically changing paths or if a device gets manually removed. Note also that these items, if using an update interval of 3 hours or more, will always return '0'.

³ `vfs.dev.read[]`, `vfs.dev.write[]`: If default *all* is used for the first parameter then the key will return summary statistics, including all block devices like *sda*, *sdb*, and their partitions (*sda1*, *sda2*, *sdb3*...) and multiple devices (MD raid) based on those block devices/partitions and logical volumes (LVM) based on those block devices/partitions. In such cases returned values should be considered only as relative value (dynamic in time) but not as absolute values.

⁴ SSL (HTTPS) is supported only if agent is compiled with cURL support. Otherwise the item will turn unsupported.

⁵ The `bytes` and `errors` values are not supported for loopback interfaces on Solaris systems up to and including Solaris 10 6/06 as `byte`, `error` and utilization statistics are not stored and/or reported by the kernel. However, if you're monitoring a Solaris system via `net-snmp`, values may be returned as `net-snmp` carries legacy code from the `cmu-snmp` dated as old as 1997 that, upon failing to read byte values from the interface statistics returns the packet counter (which does exist on loopback interfaces) multiplied by an arbitrary value of 308. This makes the assumption that the average length of a packet is 308 octets, which is a very rough estimation as the MTU limit on Solaris systems for loopback interfaces is 8892 bytes. These values should not be assumed to be correct or even closely accurate. They are guesstimates. The Zabbix agent does not do any guess work, but `net-snmp` will return a value for these fields.

⁶ The command line on Solaris, obtained from `/proc/pid/psinfo`, is limited to 80 bytes and contains the command line as it was when the process was started.

⁷ `vfs.file.contents[]`, `vfs.file.regexp[]`, `vfs.file.regmatch[]` items can be used for retrieving file contents. If you want to restrict access to specific files with sensitive information, run Zabbix agent under a user that has no access permissions to viewing these files.

Usage with command-line utilities

Note that when testing or using item keys with `zabbix_agentd` or `zabbix_get` from the command line you should consider shell syntax too.

For example, if a certain parameter of the key has to be enclosed in double quotes you have to explicitly escape double quotes, otherwise they will be trimmed by the shell as special characters and will not be passed to the Zabbix utility.

Examples:

```
zabbix_agentd -t 'vfs.dir.count[/var/log,,,"file,dir",,0]'
```

```
zabbix_agentd -t 'vfs.dir.count[/var/log,,,\"file,dir\",,0]'
```

Encoding settings

To make sure that the acquired data are not corrupted you may specify the correct encoding for processing the check (e.g. 'vfs.file.contents') in the `encoding` parameter. The list of supported encodings (code page identifiers) may be found in documentation for [libiconv](#) (GNU Project) or in Microsoft Windows SDK documentation for "Code Page Identifiers".

If no encoding is specified in the `encoding` parameter the following resolution strategies are applied:

- If encoding is not specified (or is an empty string) it is assumed to be UTF-8, the data is processed "as-is";
- BOM analysis - applicable for items 'vfs.file.contents', 'vfs.file.regexp', 'vfs.file.regmatch'. An attempt is made to determine the correct encoding by using the byte order mark (BOM) at the beginning of the file. If BOM is not present - standard resolution (see above) is applied instead.

Troubleshooting agent items

In case of passive checks, to prevent that item does not get any value because the server request to the agent times out first, the following should be noted:

- Where agent version is older than server version, the `Timeout` value in the [item configuration](#) (or [global timeout](#)) may need to be higher than the `Timeout` value in the agent [configuration file](#).
- Where agent version is newer than server version, the `Timeout` value in the server [configuration file](#) may need to be higher than the `Timeout` value in the agent [configuration file](#).

1 Zabbix agent 2

Zabbix agent 2 supports all item keys supported for Zabbix agent on [Unix](#) and [Windows](#). This page provides details on the additional item keys, which you can use with Zabbix agent 2 only, grouped by the plugin they belong to.

The item keys are listed without parameters and additional information. Click on the item key to see the full details.

Item key	Description	Plugin
ceph.df.details	The cluster's data usage and distribution among pools.	Ceph
ceph.osd.stats	Aggregated and per OSD statistics.	
ceph.osd.discovery	The list of discovered OSDs.	
ceph.osd.dump	The usage thresholds and statuses of OSDs.	
ceph.ping	Tests whether a connection to Ceph can be established.	
ceph.pool.discovery	The list of discovered pools.	
ceph.status	The overall cluster's status.	
docker.container_info	Low-level information about a container.	Docker
docker.container_stats	The container resource usage statistics.	
docker.containers	Returns the list of containers.	
docker.containers.discovery	Returns the list of containers. Used for low-level discovery.	
docker.data.usage	Information about the current data usage.	
docker.images	Returns the list of images.	
docker.images.discovery	Returns the list of images. Used for low-level discovery.	
docker.info	The system information.	
docker.ping	Test if the Docker daemon is alive or not.	
ember.get	Returns the result of the required device.	Ember+
memcached.ping	Test if a connection is alive or not.	Memcached

Item key	Description	Plugin
memcached.stats	Gets the output of the STATS command.	
mongodb.collection.stats	Returns a variety of storage statistics for a given collection.	MongoDB
mongodb.collections.discovered	Returns a list of discovered collections.	
mongodb.collections.usage	Returns the usage statistics for collections.	
mongodb.connpool.stats	Returns information regarding the open outgoing connections from the current database instance to other members of the sharded cluster or replica set.	
mongodb.db.stats	Returns the statistics reflecting a given database system state.	
mongodb.db.discovery	Returns a list of discovered databases.	
mongodb.jumbo_chunks.count	Returns the count of jumbo chunks.	
mongodb.oplog.stats	Returns the status of the replica set, using data polled from the oplog.	
mongodb.ping	Test if a connection is alive or not.	
mongodb.rs.config	Returns the current configuration of the replica set.	
mongodb.rs.status	Returns the replica set status from the point of view of the member where the method is run.	
mongodb.server.status	Returns the database state.	
mongodb.sh.discovery	Returns the list of discovered shards present in the cluster.	
mongodb.version	Returns the database server version.	
mqtt.get	Subscribes to a specific topic or topics (with wildcards) of the provided broker and waits for publications.	MQTT
mssql.availability.group.get	Returns availability groups.	MSSQL
mssql.custom.query	Returns the result of a custom query.	
mssql.db.get	Returns all available MSSQL databases.	
mssql.job.status.get	Returns the status of jobs.	
mssql.last.backup.get	Returns the last backup time for all databases.	
mssql.local.db.get	Returns databases that are participating in an Always On availability group and replica (primary or secondary) and are located on the server that the connection was established to.	
mssql.mirroring.get	Returns mirroring info.	
mssql.nonlocal.db.get	Returns databases that are participating in an Always On availability group and replica (primary or secondary) located on other servers (the database is not local to the SQL Server instance that the connection was established to).	
mssql.perfcounter.get	Returns the performance counters.	
mssql.ping	Test if a connection is alive or not.	
mssql.quorum.get	Returns the quorum info.	
mssql.quorum.member.get	Returns the quorum members.	
mssql.replica.get	Returns the replicas.	
mssql.version	Returns the MSSQL version.	
mysql.custom.query	Returns the result of a custom query.	MySQL
mysql.db.discovery	Returns the list of MySQL databases.	
mysql.db.size	The database size in bytes.	
mysql.get_status_variables	Values of the global status variables.	
mysql.ping	Test if a connection is alive or not.	
mysql.replication.discovery	Returns the list of MySQL replications.	
mysql.replication.get_slave_status	Returns the replication status.	
mysql.version	The MySQL version.	
net.dns.get	Performs a DNS query and returns detailed DNS record information.	Network
nvml.device.count	The number of GPU devices.	NVIDIA GPU
nvml.device.decoder.utilization	GPU device decoder utilization.	
nvml.device.ecc.mode	GPU device ECC mode.	
nvml.device.encoder.stats	GPU device encoder statistics.	
nvml.device.encoder.utilization	GPU device encoder utilization.	
nvml.device.energy.consumption	GPU device energy consumption.	
nvml.device.errors.memory	GPU device ECC memory error information.	
nvml.device.errors.register	GPU device ECC register error information.	
nvml.device.fan.speed.avg	GPU device fan speed average.	
nvml.device.get	Discovered GPUs with UUID and name.	
nvml.device.graphics.frequency	GPU device graphics clock speed.	
nvml.device.memory.bar1	GPU device BAR1 memory information.	
nvml.device.memory.fb.get	GPU device framebuffer memory information.	
nvml.device.memory.frequency	GPU device memory clock speed.	

Item key	Description	Plugin
nvml.device.pci.utilization	GPU device PCI utilization.	
nvml.device.performance.state	GPU device performance state.	
nvml.device.power.limit	GPU device power limit.	
nvml.device.power.usage	GPU device power usage.	
nvml.device.serial	GPU device serial number.	
nvml.device.sm.frequency	GPU device streaming multiprocessor clock speed.	
nvml.device.temperature	GPU device temperature.	
nvml.device.utilization	GPU device utilization statistics.	
nvml.device.video.frequency	GPU device video clock speed.	
nvml.system.driver.version	The NVIDIA driver version.	
nvml.version	The NVML library version.	
oracle.diskgroups.stats	Returns the Automatic Storage Management (ASM) disk groups statistics.	Oracle
oracle.diskgroups.discovery	Returns the list of ASM disk groups.	
oracle.archive.info	The archive logs statistics.	
oracle.cdb.info	The Container Databases (CDBs) information.	
oracle.custom.query	The result of a custom query.	
oracle.datafiles.stats	Returns the data files statistics.	
oracle.db.discovery	Returns the list of databases.	
oracle.fra.stats	Returns the Fast Recovery Area (FRA) statistics.	
oracle.instance.info	The instance statistics.	
oracle.pdb.info	The Pluggable Databases (PDBs) information.	
oracle.pdb.discovery	Returns the list of PDBs.	
oracle.pga.stats	Returns the Program Global Area (PGA) statistics.	
oracle.ping	Test whether a connection to Oracle can be established.	
oracle.proc.stats	Returns the processes statistics.	
oracle.redolog.info	The log file information from the control file.	
oracle.sga.stats	Returns the System Global Area (SGA) statistics.	
oracle.sessions.stats	Returns the sessions statistics.	
oracle.sys.metrics	Returns a set of system metric values.	
oracle.sys.params	Returns a set of system parameter values.	
oracle.ts.stats	Returns the tablespaces statistics.	
oracle.ts.discovery	Returns a list of tablespaces.	
oracle.user.info	Returns Oracle user information.	
oracle.version	Returns the database server version.	
pgsql.autovacuum.count	The number of autovacuum workers.	PostgreSQL
pgsql.archive	The information about archived files.	
pgsql.bgwriter	The combined number of checkpoints for the database cluster, broken down by checkpoint type.	
pgsql.cache.hit	The PostgreSQL buffer cache hit rate.	
pgsql.connections	Returns connections by type.	
pgsql.custom.query	Returns the result of a custom query.	
pgsql.db.age	The age of the oldest FrozenXID of the database.	
pgsql.db.bloating_tables	The number of bloating tables per database.	
pgsql.db.discovery	The list of PostgreSQL databases.	
pgsql.db.size	The database size in bytes.	
pgsql.dbstat	Collects the statistics per database.	
pgsql.dbstat.sum	The summarized data for all databases in a cluster.	
pgsql.locks	The information about granted locks per database.	
pgsql.oldest.xid	The age of the oldest XID.	
pgsql.ping	Test if a connection is alive or not.	
pgsql.queries	Query metrics by execution time.	
pgsql.replication.count	The number of standby servers.	
pgsql.replication.process	The flush lag, write lag and replay lag per each sender process.	
pgsql.replication.process.discovery	The replication process name discovery.	
pgsql.replication.recovery_time	The recovery status.	
pgsql.replication.status	The status of replication.	
pgsql.replication_lag.b	The replication lag in bytes.	
pgsql.replication_lag.sec	The replication lag in seconds.	
pgsql.uptime	The PostgreSQL uptime in milliseconds.	
pgsql.version	Returns PostgreSQL version.	
pgsql.wal.stat	The WAL statistics.	

Item key	Description	Plugin
redis.config	Gets the configuration parameters of a Redis instance that match the pattern.	Redis
redis.info	Gets the output of the INFO command.	
redis.ping	Test if a connection is alive or not.	
redis.slowlog.count	The number of slow log entries since Redis was started.	
smart.attribute.discovery	Returns a list of S.M.A.R.T. device attributes.	S.M.A.R.T.
smart.disk.discovery	Returns a list of S.M.A.R.T. devices.	
smart.disk.get	Returns all available properties of S.M.A.R.T. devices.	
systemd.unit.get	Returns all properties of a systemd unit.	Systemd
systemd.unit.info	Systemd unit information.	
systemd.unit.discovery	The list of systemd units and their details.	
web.certificate.get	Validates the certificates and returns certificate details.	Web certificates

See also:

- [Built-in plugins](#)
- [Loadable plugins](#)

Item key details

Parameters without angle brackets are mandatory. Parameters marked with angle brackets < > are optional.

`ceph.df.details[connString,<user>,<apikey>]`

 The cluster's data usage and distribution among pools.
 Return value: *JSON object*.

Parameters:

- **connString** - the URI or session name;

- **user, password** - the Ceph login credentials.

`ceph.osd.stats[connString,<user>,<apikey>]`

 Aggregated and per OSD statistics.
 Return value: *JSON object*.

Parameters:

- **connString** - the URI or session name;

- **user, password** - the Ceph login credentials.

`ceph.osd.discovery[connString,<user>,<apikey>]`

 The list of discovered OSDs. Used for **low-level discovery**.
 Return value: *JSON object*.

Parameters:

- **connString** - the URI or session name;

- **user, password** - the Ceph login credentials.

`ceph.osd.dump[connString,<user>,<apikey>]`

 The usage thresholds and statuses of OSDs.
 Return value: *JSON object*.

Parameters:

- **connString** - the URI or session name;

- **user, password** - the Ceph login credentials.

`ceph.ping[connString,<user>,<apikey>]`

 Tests whether a connection to Ceph can be established.
 Return value: *0* - connection is broken (if there is any error presented including AUTH and configuration issues); *1* - connection is successful.

Parameters:

- **connString** - the URI or session name;

- **user, password** - the Ceph login credentials.

`ceph.pool.discovery[connString,<user>,<apikey>]`

 The list of discovered pools. Used for **low-level discovery**.
 Return value: *JSON object*.

Parameters:

- **connString** - the URI or session name;

- **user, password** - the Ceph login credentials.

ceph.status[connString,<user>,<apikey>]

 The overall cluster's status.
 Return value: *JSON object*.

Parameters:

- **connString** - the URI or session name;

- **user, password** - the Ceph login credentials.

docker.container_info[<ID>,<info>]

 Low-level information about a container.
 Return value: The output of the [ContainerInspect](#) API call serialized as JSON.

Parameters:

- **ID** - the ID or name of the container;

- **info** - the amount of information returned. Supported values: *short* (default) or *full*.

The Agent 2 user ('zabbix') must be added to the 'docker' [group](#) for sufficient privileges. Otherwise the check will fail.

docker.container_stats[<ID>]

 The container resource usage statistics.
 Return value: The output of the [ContainerStats](#) API call and CPU usage percentage serialized as JSON.

Parameter:

- **ID** - the ID or name of the container.

The Agent 2 user ('zabbix') must be added to the 'docker' [group](#) for sufficient privileges. Otherwise the check will fail.

docker.containers

 The list of containers.
 Return value: The output of the [ContainerList](#) API call serialized as JSON.

The Agent 2 user ('zabbix') must be added to the 'docker' [group](#) for sufficient privileges. Otherwise the check will fail.

docker.containers.discovery[<options>]

 Returns the list of containers. Used for **low-level discovery**.
 Return value: *JSON object*.

Parameter:

- **options** - specify whether all or only running containers should be discovered. Supported values: *true* - return all containers; *false* - return only running containers (default).

The Agent 2 user ('zabbix') must be added to the 'docker' [group](#) for sufficient privileges. Otherwise the check will fail.

docker.data.usage

 Information about the current data usage.
 Return value: The output of the [SystemDataUsage](#) API call serialized as JSON.

The Agent 2 user ('zabbix') must be added to the 'docker' [group](#) for sufficient privileges. Otherwise the check will fail.

docker.images

 Returns the list of images.
 Return value: The output of the [ImageList](#) API call serialized as JSON.

The Agent 2 user ('zabbix') must be added to the 'docker' [group](#) for sufficient privileges. Otherwise the check will fail.

docker.images.discovery

 Returns the list of images. Used for **low-level discovery**.
 Return value: *JSON object*.

The Agent 2 user ('zabbix') must be added to the 'docker' [group](#) for sufficient privileges. Otherwise the check will fail.

docker.info

 The system information.
 Return value: The output of the [SystemInfo](#) API call serialized as JSON.

The Agent 2 user ('zabbix') must be added to the 'docker' [group](#) for sufficient privileges. Otherwise the check will fail.

docker.ping

 Test if the Docker daemon is alive or not.
 Return value: *1* - the connection is alive; *0* - the connection is broken.

The Agent 2 user ('zabbix') must be added to the 'docker' [group](#) for sufficient privileges. Otherwise the check will fail.

ember.get[<uri>,<path>]

 Returns the result of the required device.
 Return value: *JSON object*.

Parameters:

- **uri** - Ember+ device URI. Default: 127.0.0.1:9998;

- **path** - OID path to device. Empty by default, returns root collection data.

memcached.ping[connString,<user>,<password>]

 Test if a connection is alive or not.
 Return value: *1* - the connection is alive; *0* - the connection is broken (if there is any error presented including AUTH and configuration issues).

Parameters:

- **connString** - the URI or session name;

- **user, password** - the Memcached login credentials.

memcached.stats[connString,<user>,<password>,<type>]

 Gets the output of the STATS command.
 Return value: *JSON* - the output is serialized as JSON.

Parameters:

- **connString** - the URI or session name;

- **user, password** - the Memcached login credentials;

- **type** - stat type to be returned: *items, sizes, slabs* or *settings* (empty by default, returns general statistics).

mongodb.collection.stats[connString,<user>,<password>,<database>,collection]

 Returns a variety of storage statistics for a given collection.
 Return value: *JSON object*.

Parameters:

- **connString** - the URI or session name;

- **user, password** - the MongoDB login credentials;

- **database** - the database name (default: admin);

- **collection** - the collection name.

mongodb.collections.discovery[connString,<user>,<password>]

 Returns a list of discovered collections. Used for **low-level discovery**.
 Return value: *JSON object*.

Parameters:

- **connString** - the URI or session name;

- **user, password** - the MongoDB login credentials.

mongodb.collections.usage[connString,<user>,<password>]

 Returns the usage statistics for collections.
 Return value: *JSON object*.

Parameters:

- **connString** - the URI or session name;

- **user, password** - the MongoDB login credentials.

mongodb.connpool.stats[connString,<user>,<password>]

 Returns information regarding the open outgoing connections from the current database instance to other members of the sharded cluster or replica set.
 Return value: *JSON object*.

Parameters:

- **connString** - the URI or session name;

- **user, password** - the MongoDB login credentials;

- **database** - the database name (default: admin);

- **collection** - the collection name.

mongodb.db.stats[connString,<user>,<password>,<database>]

 Returns the statistics reflecting a given database system state.
 Return value: *JSON object*.

Parameters:

- **connString** - the URI or session name;

- **user, password** - the MongoDB login credentials;

- **database** - the database name (default: admin).

mongodb.db.discovery[connString,<user>,<password>]

 Returns a list of discovered databases. Used for **low-level discovery**.
 Return value: *JSON object*.

Parameters:

- **connString** - the URI or session name;

- **user, password** - the MongoDB login credentials.

mongodb.jumbo_chunks.count[connString,<user>,<password>]

 Returns the count of jumbo chunks.
 Return value: *JSON object*.

Parameters:

- **connString** - the URI or session name;

- **user, password** - the MongoDB login credentials.

mongodb.oplog.stats[connString,<user>,<password>]

 Returns the status of the replica set, using data polled from the oplog.
 Return value: *JSON object*.

Parameters:

- **connString** - the URI or session name;

- **user, password** - the MongoDB login credentials.

mongodb.ping[connString,<user>,<password>]

 Test if a connection is alive or not.
 Return value: *1* - the connection is alive; *0* - the connection is broken (if there is any error presented including AUTH and configuration issues).

Parameters:

- **connString** - the URI or session name;

- **user, password** - the MongoDB login credentials.

mongodb.rs.config[connString,<user>,<password>]

 Returns the current configuration of the replica set.
 Return value: *JSON object*.

Parameters:

- **connString** - the URI or session name;

- **user, password** - the MongoDB login credentials.

mongodb.rs.status[connString,<user>,<password>]

 Returns the replica set status from the point of view of the member where the method is run.
 Return value: *JSON object*.

Parameters:

- **connString** - the URI or session name;

- **user, password** - the MongoDB login credentials.

mongodb.server.status[connString,<user>,<password>]

 Returns the database state.
 Return value: *JSON object*.

Parameters:

- **connString** - the URI or session name;

- **user, password** - the MongoDB login credentials.

mongodb.sh.discovery[connString,<user>,<password>]

 Returns the list of discovered shards present in the cluster.
 Return value: *JSON object*.

Parameters:

- **connString** - the URI or session name;

- **user, password** - the MongoDB login credentials.

mongodb.version[connString,<user>,<password>]

 Returns the database server version.
 Return value: *String*.

Parameters:

- **connString** - the URI or session name;

- **user, password** - the MongoDB login credentials.

mqtt.get[<broker url>,topic,<user>,<password>]

 Subscribes to a specific topic or topics (with wildcards) of the provided broker and waits for publications.
 Return value: Depending on topic content. If wildcards are used, returns topic content as JSON.

Parameters:

- **broker url** - the MQTT broker URL in the format protocol://host:port without query parameters (supported protocols: tcp, ssl, ws). If no value is specified, the agent will use tcp://localhost:1883. If a protocol or port are omitted, default protocol (tcp) or port (1883) will be used;

- **topic** - the MQTT topic (mandatory). Wildcards (+,#) are supported;

- **user, password** - the authentication credentials (if required).

Comments:

- The item must be configured as an **active check** ('Zabbix agent (active)' item type);
- TLS encryption certificates can be used by saving them into a default location (e.g. /etc/ssl/certs/ directory for Ubuntu). For TLS, use the tls:// scheme.

mssql.availability.group.get[URI,<user>,<password>]

 Returns availability groups.
 Return value: *JSON object*.

Parameters:

- **URI** - MSSQL server URI (the only supported schema is sqlserver://). Embedded credentials will be ignored. It is possible to specify an instance name as part of the URI, i.e.: sqlserver://localhost/InstanceName (no port). If port is specified, the instance name is ignored;

- **user, password** - username, password to send to protected MSSQL server.

For more information see the [MSSQL plugin](#) readme.

mssql.custom.query[URI,<user>,<password>,queryName,<args...>]

 Returns the result of a custom query.
 Return value: *JSON object*.

Parameters:

- **URI** - MSSQL server URI (the only supported schema is sqlserver://). Embedded credentials will be ignored. It is possible to specify an instance name as part of the URI, i.e.: sqlserver://localhost/InstanceName (no port). If port is specified, the instance name is ignored;

- **user, password** - username, password to send to protected MSSQL server;

- **queryName** - name of a custom query configured in Plugins.MSSQL.CustomQueriesDir without the .sql extension;

- **args** - one or several comma-separated arguments to pass to a query.

For more information see the [MSSQL plugin](#) readme.

mssql.db.get

 Returns all available MSSQL databases.
 Return value: *JSON object*.

For more information see the [MSSQL plugin](#) readme.

mssql.job.status.get

 Returns the status of jobs.
 Return value: *JSON object*.

For more information see the [MSSQL plugin](#) readme.

mssql.last.backup.get

 Returns the last backup time for all databases.
 Return value: *JSON object*.

For more information see the [MSSQL plugin](#) readme.

mssql.local.db.get

 Returns databases that are participating in an Always On availability group and replica (primary or secondary) and are located on the server that the connection was established to.
 Return value: *JSON object*.

For more information see the [MSSQL plugin](#) readme.

mssql.mirroring.get

 Returns mirroring info.
 Return value: *JSON object*.

For more information see the [MSSQL plugin](#) readme.

mssql.nonlocal.db.get

 Returns databases that are participating in an Always On availability group and replica (primary or secondary) located on other servers (the database is not local to the SQL Server instance that the connection was established to).
 Return value: *JSON object*.

For more information see the [MSSQL plugin](#) readme.

mssql.perfcounter.get

 Returns the performance counters.
 Return value: *JSON object*.

For more information see the [MSSQL plugin](#) readme.

mssql.ping

 Ping the database. Test if connection is correctly configured.
 Return value: 1 - alive, 0 - not alive.

For more information see the [MSSQL plugin](#) readme.

mssql.quorum.get

 Returns the quorum info.
 Return value: *JSON object*.

For more information see the [MSSQL plugin](#) readme.

mssql.quorum.member.get

 Returns the quorum members.
 Return value: *JSON object*.

For more information see the [MSSQL plugin](#) readme.

mssql.replica.get

 Returns the replicas.
 Return value: *JSON object*.

For more information see the [MSSQL plugin](#) readme.

mssql.version

 Returns the MSSQL version.
 Return value: *String*.

For more information see the [MSSQL plugin](#) readme.

mysql.custom.query[connString,<user>,<password>,queryName,<args...>]

 Returns the result of a custom query.
 Return value: *JSON object*.

Parameters:

- **connString** - URI or session name;

- **user, password** - MySQL login credentials;

- **queryName** - name of a custom query, must match SQL file name without an extension;

- **args** - one or several comma-separated arguments to pass to a query.

For more information see the [MySQL plugin](#) readme.

mysql.db.discovery[connString,<user>,<password>]

 Returns the list of MySQL databases. Used for **low-level discovery**.
 Return value: The result of the "show databases" SQL query in LLD JSON format.

Parameters:

- **connString** - the URI or session name;

- **user, password** - the MySQL login credentials.

mysql.db.size[connString,<user>,<password>,<database name>]

 The database size in bytes.
 Return value: Result of the "select coalesce(sum(data_length + index_length),0) as size from information_schema.tables where table_schema=?" SQL query for specific database in bytes.

Parameters:

- **connString** - the URI or session name;

- **user, password** - the MySQL login credentials;

- **database name** - the database name.

mysql.get_status_variables[connString,<user>,<password>]

 Values of the global status variables.
 Return value: Result of the "show global status" SQL query in JSON format.

Parameters:

- **connString** - the URI or session name;

- **user, password** - the MySQL login credentials.

mysql.ping[connString,<user>,<password>]

 Test if a connection is alive or not.
 Return value: *1* - the connection is alive; *0* - the connection is broken (if there is any error presented including AUTH and configuration issues).

Parameters:

- **connString** - the URI or session name;

- **user, password** - the MySQL login credentials.

mysql.replication.discovery[connString,<user>,<password>]

 Returns the list of MySQL replications. Used for **low-level discovery**.
 Return value: The result of the "show slave status" SQL query in LLD JSON format.

Parameters:

- **connString** - the URI or session name;

- **user, password** - the MySQL login credentials.

mysql.replication.get_slave_status[connString,<user>,<password>,<master host>]

 The replication status.
 Return value: Result of the "show slave status" SQL query in JSON format.

Parameters:

- **connString** - the URI or session name;

- **user, password** - the MySQL login credentials;

- **master host** - the replication master host name. If none found, an error is returned. If this parameter is not specified, all hosts are returned.

mysql.version[connString,<user>,<password>]

 The MySQL version.
 Return value: *String* (with the MySQL instance version).

Parameters:

- **connString** - the URI or session name;

- **user, password** - the MySQL login credentials.

net.dns.get[<ip>,name,<type>,<timeout>,<count>,<protocol>,"<flags>"]

Performs a DNS query and returns detailed DNS record information.
 This item is an extended version of the **net.dns.record** Zabbix agent item with more record types and customizable flags supported.
 Return values: *JSON object*

Parameters:

- **ip** - the IP address of DNS server (leave empty for the default DNS server);
- **name** - the DNS name to query;
- **type** - the record type to be queried (default is *SOA*);
- **timeout** - the timeout for the request in seconds (default is 1 second);
- **count** - the number of tries for the request (default is 2);
- **protocol** - the protocol used to perform DNS queries: *udp* (default) or *tcp*;
- **flags** - one or more comma-separated arguments to pass to a query.

Comments:

- The possible values for type are: *A, NS, MD, MF, CNAME, SOA, MB, MG, MR, NULL, PTR, HINFO, MINFO, MX, TXT, RP, AFSDB, X25, ISDN, RT, NSAPTR, SIG, KEY, PX, GPOS, AAAA, LOC, NXT, EID, NIMLOC, SRV, ATMA, NAPTR, KX, CERT, DNAME, OPT, APL, DS, SSHFP, IPSECKEY, RRSIG, NSEC, DNSKEY, DHCID, NSEC3, NSEC3PARAM, TLSA, SMIMEA, HIP, NINFO, RKEY, TALINK, CDS, CDNSKEY, OPENPGPKEY, CSYNC, ZONEMD, SVCB, HTTPS, SPF, UINFO, UID, GID, UNSPEC, NID, L32, L64, LP, EUI48, EUI64, URI, CAA, AVC, AMTRELAY*. Note that values must be in uppercase only; lowercase or mixed case values are not supported.
- For reverse DNS lookups (when type is set to *PTR*), you can provide the DNS name in both reversed and non-reversed format (see examples below). Note that when PTR record is requested, the DNS name is actually an IP address.

- The possible values for flags are: *cdflag* or *nocdflag* (default), *rdflag* (default) or *nordflag*, *dnssec* or *nodnssec* (default), *nsid* or *nonsid* (default), *edns0* (default) or *noedns0*, *aafld* or *noaafld* (default), *adflag* or *noadflag* (default). The flags *dnssec* and *nsid* cannot be used together with *noedns0*, as both require *edns0*. Note that values must be in lowercase only; uppercase case or mixed case values are not supported.
- Internationalized domain names are not supported, please use IDNA encoded names instead.
- The output is an object containing DNS record information based on the parameters provided (see [more details](#)).

Examples:

```
net.dns.get[192.0.2.0,zabbix.com,DNSKEY,3,3,tcp,"cdflag,rdflag,nsid"]
```

```
net.dns.get[,198.51.100.1,PTR,,,"cdflag,rdflag,nsid"]
net.dns.get[,1.100.51.198.in-addr.arpa,PTR,,,"cdflag,rdflag,nsid"]
```

```
net.dns.get[,2a00:1450:400f:800::200e,PTR,,,"cdflag,rdflag,nsid"]
net.dns.get[,e.0.0.2.0.0.0.0.0.0.0.0.0.0.0.0.0.8.0.f.0.0.4.0.5.4.1.0.0.a.2.ip6.arpa,PTR,,,"cdflag,rdflag,nsid"]
```

```
nvml.device.count
```

 The number of GPU devices.
 Return value: *Integer*.

For more information see the [NVIDIA GPU plugin](#) readme.

```
nvml.device.decoder.utilization[<deviceUUID>]
```

 GPU device decoder utilization as a percentage.
 Return value: *Integer*.

Parameter:

- **deviceUUID** - GPU device UUID.

For more information see the [NVIDIA GPU plugin](#) readme.

```
nvml.device.ecc.mode[<deviceUUID>]
```

 GPU device ECC mode information (current, pending).
 Return value: *JSON*.

Parameter:

- **deviceUUID** - GPU device UUID.

For more information see the [NVIDIA GPU plugin](#) readme.

```
nvml.device.encoder.stats.get[<deviceUUID>]
```

 GPU device encoder statistics.
 Return value: *JSON*.

Parameter:

- **deviceUUID** - GPU device UUID.

For more information see the [NVIDIA GPU plugin](#) readme.

```
nvml.device.encoder.utilization[<deviceUUID>]
```

 GPU device encoder utilization as a percentage.
 Return value: *Integer*.

Parameter:

- **deviceUUID** - GPU device UUID.

For more information see the [NVIDIA GPU plugin](#) readme.

```
nvml.device.energy.consumption[<deviceUUID>]
```

 GPU device total energy consumption in millijoules (mj) since the driver was last reloaded.
 Return value: *Integer*.

Parameter:

- **deviceUUID** - GPU device UUID.

For more information see the [NVIDIA GPU plugin](#) readme.

```
nvml.device.errors.memory[<deviceUUID>]
```

 GPU device ECC memory error information (corrected, uncorrected).
 Return value: *JSON*.

Parameter:

- **deviceUUID** - GPU device UUID.

For more information see the [NVIDIA GPU plugin](#) readme.

`nvml.device.errors.register[<deviceUUID>]`

 GPU device ECC register error information (corrected, uncorrected).
 Return value: *JSON*.

Parameter:

- **deviceUUID** - GPU device UUID.

For more information see the [NVIDIA GPU plugin](#) readme.

`nvml.device.fan.speed.avg[<deviceUUID>]`

 GPU device average fan speed as a percentage of maximum speed.
 Return value: *Integer*.

Parameter:

- **deviceUUID** - GPU device UUID.

For more information see the [NVIDIA GPU plugin](#) readme.

`nvml.device.get`

 Discovered GPUs with UUID and name.
 Return value: *JSON*.

For more information see the [NVIDIA GPU plugin](#) readme.

`nvml.device.graphics.frequency[<deviceUUID>]`

 GPU device graphics clock speed in MHz.
 Return value: *Integer*.

Parameter:

- **deviceUUID** - GPU device UUID.

For more information see the [NVIDIA GPU plugin](#) readme.

`nvml.device.memory.fb.get[<deviceUUID>]`

 GPU device framebuffer memory statistics (total, reserved, free, used).
 Return value: *JSON*.

Parameter:

- **deviceUUID** - GPU device UUID.

For more information see the [NVIDIA GPU plugin](#) readme.

`nvml.device.memory.bar1.get[<deviceUUID>]`

 GPU device BAR1 memory statistics (total, free, used).
 Return value: *JSON*.

Parameter:

- **deviceUUID** - GPU device UUID.

For more information see the [NVIDIA GPU plugin](#) readme.

`nvml.device.memory.frequency[<deviceUUID>]`

 GPU device memory clock speed in MHz.
 Return value: *Integer*.

Parameter:

- **deviceUUID** - GPU device UUID.

For more information see the [NVIDIA GPU plugin](#) readme.

`nvml.device.pci.utilization[<deviceUUID>]`

 GPU device PCI utilization (transmit/receive throughput in KBps).
 Return value: *JSON*.

Parameter:

- **deviceUUID** - GPU device UUID.

For more information see the [NVIDIA GPU plugin](#) readme.

`nvml.device.performance.state[<deviceUUID>]`

 GPU device performance state.
 Return value: *Integer*.

Parameter:

- **deviceUUID** - GPU device UUID.

For more information see the [NVIDIA GPU plugin](#) readme.

`nvml.device.power.limit[<deviceUUID>]`

 GPU device power limit in milliwatts.
 Return value: *Integer*.

Parameter:

- **deviceUUID** - GPU device UUID.

For more information see the [NVIDIA GPU plugin](#) readme.

`nvml.device.power.usage[<deviceUUID>]`

 GPU device current power usage in milliwatts.
 Return value: *Integer*.

Parameter:

- **deviceUUID** - GPU device UUID.

For more information see the [NVIDIA GPU plugin](#) readme.

`nvml.device.serial[<deviceUUID>]`

 GPU device serial number.
 Return value: *String*.

Parameter:

- **deviceUUID** - GPU device UUID.

For more information see the [NVIDIA GPU plugin](#) readme.

`nvml.device.sm.frequency[<deviceUUID>]`

 GPU device streaming multiprocessor clock speed in MHz.
 Return value: *Integer*.

Parameter:

- **deviceUUID** - GPU device UUID.

For more information see the [NVIDIA GPU plugin](#) readme.

`nvml.device.temperature[<deviceUUID>]`

 GPU device temperature in Celsius.
 Return value: *Integer*.

Parameter:

- **deviceUUID** - GPU device UUID.

For more information see the [NVIDIA GPU plugin](#) readme.

`nvml.device.utilization[<deviceUUID>]`

 GPU device utilization statistics (GPU/memory utilization as a percentage).
 Return value: *JSON*.

Parameter:

- **deviceUUID** - GPU device UUID.

For more information see the [NVIDIA GPU plugin](#) readme.

`nvml.device.video.frequency[<deviceUUID>]`

 GPU device video clock speed in MHz.
 Return value: *Integer*.

Parameter:

- **deviceUUID** - GPU device UUID.

For more information see the [NVIDIA GPU plugin](#) readme.

`nvml.system.driver.version`

 The NVIDIA driver version.
 Return value: *String*.

For more information see the [NVIDIA GPU plugin](#) readme.

`nvml.version`

 The NVML library version.
 Return value: *String*.

For more information see the [NVIDIA GPU plugin](#) readme.

oracle.diskgroups.stats[connString,<user>,<password>,<service>,<diskgroup>]

 Returns the Automatic Storage Management (ASM) disk groups statistics.
 Return value: *JSON object*.

Parameters:

- **connString** - the URI or session name;

- **user** - the Oracle username, supports appending one of the login options as sysdba, as sysoper, or as sysasm in the format user as sysdba (a login option is case-insensitive, must not contain a trailing space);

- **password** - the Oracle password;

- **service** - the Oracle service name;

- **diskgroup** - the name of the ASM disk group to query.

oracle.diskgroups.discovery[connString,<user>,<password>,<service>]

 Returns the list of ASM disk groups. Used for **low-level discovery**.
 Return value: *JSON object*.

Parameters:

- **connString** - the URI or session name;

- **user** - the Oracle username, supports appending one of the login options as sysdba, as sysoper, or as sysasm in the format user as sysdba (a login option is case-insensitive, must not contain a trailing space);

- **password** - the Oracle password;

- **service** - the Oracle service name.

oracle.archive.info[connString,<user>,<password>,<service>,<destination>]

 The archive logs statistics.
 Return value: *JSON object*.

Parameters:

- **connString** - the URI or session name;

- **user** - the Oracle username, supports appending one of the login options as sysdba, as sysoper, or as sysasm in the format user as sysdba (a login option is case-insensitive, must not contain a trailing space);

- **password** - the Oracle password;

- **service** - the Oracle service name;

- **destination** - the name of the destination to query.

oracle.cdb.info[connString,<user>,<password>,<service>,<database>]

 The Container Databases (CDBs) information.
 Return value: *JSON object*.

Parameters:

- **connString** - the URI or session name;

- **user** - the Oracle username, supports appending one of the login options as sysdba, as sysoper, or as sysasm in the format user as sysdba (a login option is case-insensitive, must not contain a trailing space);

- **password** - the Oracle password;

- **service** - the Oracle service name;

- **destination** - the name of the database to query.

oracle.custom.query[connString,<user>,<password>,<service>,queryName,<args...>]

 The result of a custom query.
 Return value: *JSON object*.

Parameters:

- **connString** - the URI or session name;

- **user** - the Oracle username, supports appending one of the login options as sysdba, as sysoper, or as sysasm in the format user as sysdba (a login option is case-insensitive, must not contain a trailing space);

- **password** - the Oracle password;

- **service** - the Oracle service name;

- **queryName** - the name of a custom query, must match SQL file name without an extension;

- **args** - one or several comma-separated arguments to pass to the query.

oracle.datafiles.stats[connString,<user>,<password>,<service>]

 Returns the data files statistics.
 Return value: *JSON object*.

Parameters:

- **connString** - the URI or session name;

- **user** - the Oracle username, supports appending one of the login options as sysdba, as sysoper, or as sysasm in the format user as sysdba (a login option is case-insensitive, must not contain a trailing space);

- **password** - the Oracle password;

- **service** - the Oracle service name;

- **diskgroup** - the name of the ASM disk group to query.

oracle.db.discovery[connString,<user>,<password>,<service>]

 Returns the list of databases. Used for **low-level discovery**.
 Return value: *JSON object*.

Parameters:

- **connString** - the URI or session name;

- **user** - the Oracle username, supports appending one of the login options as sysdba, as sysoper, or as sysasm in the format user as sysdba (a login option is case-insensitive, must not contain a trailing space);

- **password** - the Oracle password;

- **service** - the Oracle service name.

oracle.fra.stats[connString,<user>,<password>,<service>]

 Returns the Fast Recovery Area (FRA) statistics.
 Return value: *JSON object*.

Parameters:

- **connString** - the URI or session name;

- **user** - the Oracle username, supports appending one of the login options as sysdba, as sysoper, or as sysasm in the format user as sysdba (a login option is case-insensitive, must not contain a trailing space);

- **password** - the Oracle password;

- **service** - the Oracle service name.

oracle.instance.info[connString,<user>,<password>,<service>]

 The instance statistics.
 Return value: *JSON object*.

Parameters:

- **connString** - the URI or session name;

- **user** - the Oracle username, supports appending one of the login options as sysdba, as sysoper, or as sysasm in the format user as sysdba (a login option is case-insensitive, must not contain a trailing space);

- **password** - the Oracle password;

- **service** - the Oracle service name.

oracle.pdb.info[connString,<user>,<password>,<service>,<database>]

 The Pluggable Databases (PDBs) information.
 Return value: *JSON object*.

Parameters:

- **connString** - the URI or session name;

- **user** - the Oracle username, supports appending one of the login options as sysdba, as sysoper, or as sysasm in the format user as sysdba (a login option is case-insensitive, must not contain a trailing space);

- **password** - the Oracle password;

- **service** - the Oracle service name;

- **destination** - the name of the database to query.

oracle.pdb.discovery[connString,<user>,<password>,<service>]

 Returns the list of PDBs. Used for **low-level discovery**.
 Return value: *JSON object*.

Parameters:

- **connString** - the URI or session name;

- **user** - the Oracle username, supports appending one of the login options as sysdba, as sysoper, or as sysasm in the format user as sysdba (a login option is case-insensitive, must not contain a trailing space);

- **password** - the Oracle password;

- **service** - the Oracle service name.

oracle.pga.stats[connString,<user>,<password>,<service>]

 Returns the Program Global Area (PGA) statistics.
 Return value: *JSON object*.

Parameters:

- **connString** - the URI or session name;

- **user** - the Oracle username, supports appending one of the login options as `sysdba`, as `sysoper`, or as `sysasm` in the format `user as sysdba` (a login option is case-insensitive, must not contain a trailing space);

- **password** - the Oracle password;

- **service** - the Oracle service name.

oracle.ping[connString,<user>,<password>,<service>]

 Test whether a connection to Oracle can be established.
 Return value: *1* - the connection is successful; *0* - the connection is broken (if there is any error presented including AUTH and configuration issues).

Parameters:

- **connString** - the URI or session name;

- **user** - the Oracle username, supports appending one of the login options as `sysdba`, as `sysoper`, or as `sysasm` in the format `user as sysdba` (a login option is case-insensitive, must not contain a trailing space);

- **password** - the Oracle password;

- **service** - the Oracle service name.

oracle.proc.stats[connString,<user>,<password>,<service>]

 Returns the processes statistics.
 Return value: *JSON object*.

Parameters:

- **connString** - the URI or session name;

- **user** - the Oracle username, supports appending one of the login options as `sysdba`, as `sysoper`, or as `sysasm` in the format `user as sysdba` (a login option is case-insensitive, must not contain a trailing space);

- **password** - the Oracle password;

- **service** - the Oracle service name.

oracle.redolog.info[connString,<user>,<password>,<service>]

 The log file information from the control file.
 Return value: *JSON object*.

Parameters:

- **connString** - the URI or session name;

- **user** - the Oracle username, supports appending one of the login options as `sysdba`, as `sysoper`, or as `sysasm` in the format `user as sysdba` (a login option is case-insensitive, must not contain a trailing space);

- **password** - the Oracle password;

- **service** - the Oracle service name.

oracle.sga.stats[connString,<user>,<password>,<service>]

 Returns the System Global Area (SGA) statistics.
 Return value: *JSON object*.

Parameters:

- **connString** - the URI or session name;

- **user** - the Oracle username, supports appending one of the login options as `sysdba`, as `sysoper`, or as `sysasm` in the format `user as sysdba` (a login option is case-insensitive, must not contain a trailing space);

- **password** - the Oracle password;

- **service** - the Oracle service name.

oracle.sessions.stats[connString,<user>,<password>,<service>,<lockMaxTime>]

 Returns the sessions statistics.
 Return value: *JSON object*.

Parameters:

- **connString** - the URI or session name;

- **user** - the Oracle username, supports appending one of the login options as `sysdba`, as `sysoper`, or as `sysasm` in the format `user as sysdba` (a login option is case-insensitive, must not contain a trailing space);

- **password** - the Oracle password;

- **service** - the Oracle service name;

- **lockMaxTime** - the maximum session lock duration in seconds to count the session as a prolongedly locked. Default: 600 seconds.

oracle.sys.metrics[connString,<user>,<password>,<service>,<duration>]

 Returns a set of system metric values.
 Return value: *JSON object*.

Parameters:

- **connString** - the URI or session name;

- **user** - the Oracle username, supports appending one of the login options `as sysdba`, `as sysoper`, or `as sysasm` in the format `user as sysdba` (a login option is case-insensitive, must not contain a trailing space);

- **password** - the Oracle password;

- **service** - the Oracle service name;

- **duration** - the capturing interval (in seconds) of system metric values. Possible values: `60` — long duration (default), `15` — short duration.

`oracle.sys.params[connString,<user>,<password>,<service>]`

 Returns a set of system parameter values.
 Return value: *JSON object*.

Parameters:

- **connString** - the URI or session name;

- **user** - the Oracle username, supports appending one of the login options `as sysdba`, `as sysoper`, or `as sysasm` in the format `user as sysdba` (a login option is case-insensitive, must not contain a trailing space);

- **password** - the Oracle password;

- **service** - the Oracle service name.

`oracle.ts.stats[connString,<user>,<password>,<service>,<tablespace>,<type>,<conname>]`

 Returns the tablespaces statistics.
 Return value: *JSON object*.

Parameters:

- **connString** - the URI or session name;

- **user** - the Oracle username, supports appending one of the login options `as sysdba`, `as sysoper`, or `as sysasm` in the format `user as sysdba` (a login option is case-insensitive, must not contain a trailing space);

- **password** - the Oracle password;

- **service** - the Oracle service name;

- **tablespace** - name of the tablespace to query. Default (if left empty and `type` is set):
- `"TEMP"` (if `type` is set to `"TEMPORARY"`);
- `"USERS"` (if `type` is set to `"PERMANENT"`).
- **type** - the type of the tablespace to query. Default (if `tablespace` is set): `"PERMANENT"`.
- **conname** - name of the container for which the information is required.

If `tablespace`, `type`, or `conname` is omitted, the item will return tablespace statistics for all matching containers (including PDBs and CDB).

`oracle.ts.discovery[connString,<user>,<password>,<service>]`

 Returns a list of tablespaces. Used for **low-level discovery**.
 Return value: *JSON object*.

Parameters:

- **connString** - the URI or session name;

- **user** - the Oracle username, supports appending one of the login options `as sysdba`, `as sysoper`, or `as sysasm` in the format `user as sysdba` (a login option is case-insensitive, must not contain a trailing space);

- **password** - the Oracle password;

- **service** - the Oracle service name.

`oracle.user.info[connString,<user>,<password>,<service>,<username>]`

 Returns Oracle user information.
 Return value: *JSON object*.

Parameters:

- **connString** - the URI or session name;

- **user** - the Oracle username, supports appending one of the login options `as sysdba`, `as sysoper`, or `as sysasm` in the format `user as sysdba` (a login option is case-insensitive, must not contain a trailing space);

- **password** - the Oracle password;

- **service** - the Oracle service name;

- **username** - the username for which the information is needed. Lowercase usernames are not supported. Default: `current user`.

`oracle.version[connString,<user>,<password>,<service>]`

 Returns the database server version.
 Return value: *String*.

Parameters:

- **connString** - the URI or session name;

- **user** - the Oracle username, supports appending one of the login options `as sysdba`, `as sysoper`, or `as sysasm` in the format `user as sysdba` (a login option is case-insensitive, must not contain a trailing space);

- **password** - the Oracle password;

- **service** - the Oracle service name.

pgsql.autovacuum.count[uri,<username>,<password>,<database name>]

 The number of autovacuum workers.
 Return value: *Integer*.

Parameters:

- **uri** - the URI or session name;

- **username, password** - the PostgreSQL credentials;

- **database name** - the database name.

pgsql.archive[uri,<username>,<password>,<database name>]

 The information about archived files.
 Return value: *JSON object*.

Parameters:

- **uri** - the URI or session name;

- **username, password** - the PostgreSQL credentials;

- **database name** - the database name.

pgsql.bgwriter[uri,<username>,<password>,<database name>]

 The combined number of checkpoints for the database cluster, broken down by checkpoint type.
 Return value: *JSON object*.

Parameters:

- **uri** - the URI or session name;

- **username, password** - the PostgreSQL credentials;

- **database name** - the database name.

pgsql.cache.hit[uri,<username>,<password>,<database name>]

 The PostgreSQL buffer cache hit rate.
 Return value: *Float*.

Parameters:

- **uri** - the URI or session name;

- **username, password** - the PostgreSQL credentials;

- **database name** - the database name.

pgsql.connections[uri,<username>,<password>,<database name>]

 Returns connections by type.
 Return value: *JSON object*.

Parameters:

- **uri** - the URI or session name;

- **username, password** - the PostgreSQL credentials;

- **database name** - the database name.

pgsql.custom.query[uri,<username>,<password>,queryName,<args...>]

 Returns the result of a custom query.
 Return value: *JSON object*.

Parameters:

- **uri** - the URI or session name;

- **username, password** - the PostgreSQL credentials;

- **queryName** - the name of a custom query, must match the SQL file name without an extension;

- **args** - one or several comma-separated arguments to pass to a query.

pgsql.db.age[uri,<username>,<password>,<database name>]

 The age of the oldest FrozenXID of the database.
 Return value: *Integer*.

Parameters:

- **uri** - the URI or session name;

- **username, password** - the PostgreSQL credentials;

- **database name** - the database name.

pgsql.db.bloating_tables[uri,<username>,<password>,<database name>]

 The number of bloating tables per database.
 Return value: *Integer*.

Parameters:

- **uri** - the URI or session name;

- **username, password** - the PostgreSQL credentials;

- **database name** - the database name.

pgsql.db.discovery[uri,<username>,<password>,<database name>]

 The list of PostgreSQL databases. Used for **low-level discovery**.
 Return value: *JSON object*.

Parameters:

- **uri** - the URI or session name;

- **username, password** - the PostgreSQL credentials;

- **database name** - the database name.

pgsql.db.size[uri,<username>,<password>,<database name>]

 The database size in bytes.
 Return value: *Integer*.

Parameters:

- **uri** - the URI or session name;

- **username, password** - the PostgreSQL credentials;

- **database name** - the database name.

pgsql.dbstat[uri,<username>,<password>,<database name>]

 Collects the statistics per database. Used for **low-level discovery**.
 Return value: *JSON object*.

Parameters:

- **uri** - the URI or session name;

- **username, password** - the PostgreSQL credentials;

- **database name** - the database name.

pgsql.dbstat.sum[uri,<username>,<password>,<database name>]

 The summarized data for all databases in a cluster.
 Return value: *JSON object*.

Parameters:

- **uri** - the URI or session name;

- **username, password** - the PostgreSQL credentials;

- **database name** - the database name.

pgsql.locks[uri,<username>,<password>,<database name>]

 The information about granted locks per database. Used for **low-level discovery**.
 Return value: *JSON object*.

Parameters:

- **uri** - the URI or session name;

- **username, password** - the PostgreSQL credentials;

- **database name** - the database name.

pgsql.oldest.xid[uri,<username>,<password>,<database name>]

 The age of the oldest XID.
 Return value: *Integer*.

Parameters:

- **uri** - the URI or session name;

- **username, password** - the PostgreSQL credentials;

- **database name** - the database name.

pgsql.ping[uri,<username>,<password>,<database name>]

 Tests whether a connection is alive or not.
 Return value: *1* - the connection is alive; *0* - the connection is broken (if there is any error presented including AUTH and configuration issues).

Parameters:

- **uri** - the URI or session name;

- **username, password** - the PostgreSQL credentials;

- **database name** - the database name.

pgsql.queries[uri,<username>,<password>,<database name>,<time period>]

 Queries metrics by execution time.
 Return value: *JSON object*.

Parameters:

- **uri** - the URI or session name;

- **username, password** - the PostgreSQL credentials;

- **database name** - the database name;

- **timePeriod** - the execution time limit for the count of slow queries (must be a positive integer).

pgsql.replication.count[uri,<username>,<password>]

 The number of standby servers.
 Return value: *Integer*.

Parameters:

- **uri** - the URI or session name;

- **username, password** - the PostgreSQL credentials.

pgsql.replication.process[uri,<username>,<password>]

 The flush lag, write lag and replay lag per each sender process.
 Return value: *JSON object*.

Parameters:

- **uri** - the URI or session name;

- **username, password** - the PostgreSQL credentials.

pgsql.replication.process.discovery[uri,<username>,<password>]

 The replication process name discovery.
 Return value: *JSON object*.

Parameters:

- **uri** - the URI or session name;

- **username, password** - the PostgreSQL credentials.

pgsql.replication.recovery_role[uri,<username>,<password>]

 The recovery status.
 Return value: *0* - master mode; *1* - recovery is still in progress (standby mode).

Parameters:

- **uri** - the URI or session name;

- **username, password** - the PostgreSQL credentials.

pgsql.replication.status[uri,<username>,<password>]

 The status of replication.
 Return value: *0* - streaming is down; *1* - streaming is up; *2* - master mode.

Parameters:

- **uri** - the URI or session name;

- **username, password** - the PostgreSQL credentials.

pgsql.replication_lag.b[uri,<username>,<password>]

 The replication lag in bytes.
 Return value: *Integer*.

Parameters:

- **uri** - the URI or session name;

- **username, password** - the PostgreSQL credentials.

pgsql.replication_lag.sec[uri,<username>,<password>]

 The replication lag in seconds.
 Return value: *Integer*.

Parameters:

- **uri** - the URI or session name;

- **username, password** - the PostgreSQL credentials.

pgsql.uptime[uri,<username>,<password>,<database name>]

 The PostgreSQL uptime in milliseconds.
 Return value: *Float*.

Parameters:

- **uri** - the URI or session name;

- **username, password** - the PostgreSQL credentials;

- **database name** - the database name.

pgsql.version[uri,<username>,<password>,<database name>]

 Returns PostgreSQL version.
 Return value: *String*.

Parameters:

- **uri** - the URI or session name;

- **username, password** - the PostgreSQL credentials;

- **database name** - the database name.

pgsql.wal.stat[uri,<username>,<password>,<database name>]

 The WAL statistics.
 Return value: *JSON object*.

Parameters:

- **uri** - the URI or session name;

- **username, password** - the PostgreSQL credentials;

- **database name** - the database name.

redis.config[connString,<password>,<pattern>]

 Gets the configuration parameters of a Redis instance that match the pattern.
 Return value: *JSON* - if a glob-style pattern was used; single value - if a pattern did not contain any wildcard character.

Parameters:

- **connString** - the URI or session name;

- **password** - the Redis password;

- **pattern** - a glob-style pattern (* by default).

redis.info[connString,<password>,<section>]

 Gets the output of the INFO command.
 Return value: *JSON* - the output is serialized as JSON.

Parameters:

- **connString** - the URI or session name;

- **password** - the Redis password;

- **section** - the [section](#) of information (*default* by default).

redis.ping[connString,<password>]

 Test if a connection is alive or not.
 Return value: *1* - the connection is alive; *0* - the connection is broken (if there is any error presented including AUTH and configuration issues).

Parameters:

- **connString** - the URI or session name;

- **password** - the Redis password.

redis.slowlog.count[connString,<password>]

 The number of slow log entries since Redis was started.
 Return value: *Integer*.

Parameters:

- **connString** - the URI or session name;

- **password** - the Redis password.

smart.attribute.discovery

 Returns a list of S.M.A.R.T. device attributes.
 Return value: *JSON object*.

Comments:

- The following macros and their values are returned: {#NAME}, {#DISKTYPE}, {#ID}, {#ATTRNAME}, {#THRESH};

- HDD, SSD and NVME drive types are supported. Drives can be alone or combined in a RAID. {#NAME} will have an add-on in case of RAID, e.g: {"{#NAME}": "/dev/sda cciss,2"}.

smart.disk.discovery

 Returns a list of S.M.A.R.T. devices.
 Return value: *JSON object*.

Comments:

- The following macros and their values are returned: {#NAME}, {#DISKTYPE}, {#MODEL}, {#SN}, {#PATH}, {#ATTRIBUTES}, {#RAIDTYPE};
- HDD, SSD and NVME drive types are supported. If a drive does not belong to a RAID, the {#RAIDTYPE} will be empty. {#NAME} will have an add-on in case of RAID, e.g: {"{#NAME}": "/dev/sda cciss,2"}.

smart.disk.get[<path>,<raid type>]

 Returns all available properties of S.M.A.R.T. devices.
 Return value: *JSON object*.

Parameters:

- **path** - the disk path, the {#PATH} macro may be used as a value;

- **raid_type** - the RAID type, the {#RAID} macro may be used as a value

Comments:

- HDD, SSD and NVME drive types are supported. Drives can be alone or combined in a RAID;

- The data includes smartctl version and call arguments, and additional fields:
disk_name - holds the name with the required add-ons for RAID discovery, e.g: {"disk_name": "/dev/sda cciss,2"}
disk_type - holds the disk type HDD, SSD, or NVME, e.g: {"disk_type": "ssd"};

- If no parameters are specified, the item will return information about all disks.

systemd.unit.get[unit name,<interface>]

 Returns all properties of a systemd unit.
 Return value: *JSON object*.

Parameters:

- **unit name** - the unit name (you may want to use the {#UNIT.NAME} macro in item prototype to discover the name);

- **interface** - the unit interface type, possible values: *Unit* (default), *Service*, *Socket*, *Device*, *Mount*, *Automount*, *Swap*, *Target*, *Path*.

Comments:

- This item is supported on Linux platform only;
- LoadState, ActiveState and UnitFileState for Unit interface are returned as text and integer: "ActiveState":{"state":1,"text":"a"

systemd.unit.info[unit name,<property>,<interface>]

 A systemd unit information.
 Return value: *String*.

Parameters:

- **unit name** - the unit name (you may want to use the {#UNIT.NAME} macro in item prototype to discover the name);

- **property** - unit property (e.g. ActiveState (default), LoadState, Description);
- **interface** - the unit interface type (e.g. Unit (default), Socket, Service).

Comments:

- This item is supported on Linux platform only;
- This item allows to retrieve a specific property from specific type of interface as described in [dbus API](#).

Examples:

```
systemd.unit.info["{#UNIT.NAME}"] #collect active state (active, reloading, inactive, failed, activating,
systemd.unit.info["{#UNIT.NAME}",LoadState] #collect load state info on discovered systemd units
systemd.unit.info[mysqld.service,Id] #retrieve the service technical name (mysqld.service)
systemd.unit.info[mysqld.service,Description] #retrieve the service description (MySQL Server)
systemd.unit.info[mysqld.service,ActiveEnterTimestamp] #retrieve the last time the service entered the act
systemd.unit.info[dbus.socket,NConnections,Socket] #collect the number of connections from this socket uni
```

systemd.unit.discovery[<type>]

 List of systemd units and their details. Used for **low-level discovery**.
 Return value: *JSON object*.

Parameter:

- **type** - possible values: *all*, *automount*, *device*, *mount*, *path*, *service* (default), *socket*, *swap*, *target*.

This item is supported on Linux platform only.

`web.certificate.get[hostname,<port>,<address>]`

 Validates the certificates and returns certificate details.
 Return value: *JSON object*.

Parameter:

- **hostname** - can be either IP or DNS.
May contain the URL scheme (*https* only), path (it will be ignored), and port.
If a port is provided in both the first and the second parameters, their values must match.
If address (the 3rd parameter) is specified, the hostname is only used for SNI and hostname verification;

- **port** - the port number (default is 443 for HTTPS);

- **address** - can be either IP or DNS. If specified, it will be used for connection, and hostname (the 1st parameter) will be used for SNI, and host verification. In case, the 1st parameter is an IP and the 3rd parameter is DNS, the 1st parameter will be used for connection, and the 3rd parameter will be used for SNI and host verification.

Comments:

- This item turns unsupported if the resource specified in `host` does not exist or is unavailable or if TLS handshake fails with any error except an invalid certificate;

- Currently, AIA (Authority Information Access) X.509 extension, CRLs and OCSP (including OCSP stapling), Certificate Transparency, and custom CA trust store are not supported.

2 Windows Zabbix agent

Overview

The Windows Zabbix agent items are presented in two lists:

- **Shared items** - the item keys that are shared with the UNIX Zabbix agent;
- **Windows-specific items** - the item keys that are supported **only** on Windows.

Note that all item keys supported by Zabbix agent on Windows are also supported by the new generation Zabbix agent 2. See the [additional item keys](#) that you can use with the agent 2 only.

See also: [Minimum permissions for Windows items](#)

Shared items

The table below lists Zabbix agent items that are supported on Windows and are shared with the UNIX Zabbix agent:

- The item key is a link to full details of the UNIX Zabbix agent item
- Windows-relevant item comments are included

Item key	Description	Item group
log	The monitoring of a log file. This item is not supported for Windows Event Log. The <code>persistent_dir</code> parameter is not supported on Windows.	Log monitoring
log.count	The count of matched lines in a monitored log file. This item is not supported for Windows Event Log. The <code>persistent_dir</code> parameter is not supported on Windows.	
logrt	The monitoring of a log file that is rotated. This item is not supported for Windows Event Log. The <code>persistent_dir</code> parameter is not supported on Windows.	
logrt.count	The count of matched lines in a monitored log file that is rotated. This item is not supported for Windows Event Log. The <code>persistent_dir</code> parameter is not supported on Windows.	
modbus.get	Reads Modbus data.	Modbus Network
net.dns	Checks if the DNS service is up. The <code>ip</code> , <code>timeout</code> and <code>count</code> parameters are ignored on Windows unless using Zabbix agent 2.	
net.dns.perf	Checks the performance of a DNS service. The <code>ip</code> , <code>timeout</code> and <code>count</code> parameters are ignored on Windows unless using Zabbix agent 2.	
net.dns.record	Performs a DNS query. The <code>ip</code> , <code>timeout</code> and <code>count</code> parameters are ignored on Windows unless using Zabbix agent 2.	

Item key	Description	Item group
net.if.discovery	The list of network interfaces. Some Windows versions (for example, Server 2008) might require the latest updates installed to support non-ASCII characters in interface names.	
net.if.in	The incoming traffic statistics on a network interface. On Windows, the item gets values from 64-bit counters if available. 64-bit interface statistic counters were introduced in Windows Vista and Windows Server 2008. If 64-bit counters are not available, the agent uses 32-bit counters. Multi-byte interface names on Windows are supported. You may obtain network interface descriptions on Windows with net.if.discovery or net.if.list items.	
net.if.out	The outgoing traffic statistics on a network interface. On Windows, the item gets values from 64-bit counters if available. 64-bit interface statistic counters were introduced in Windows Vista and Windows Server 2008. If 64-bit counters are not available, the agent uses 32-bit counters. Multi-byte interface names on Windows are supported. You may obtain network interface descriptions on Windows with net.if.discovery or net.if.list items.	
net.if.total	The sum of incoming and outgoing traffic statistics on a network interface. On Windows, the item gets values from 64-bit counters if available. 64-bit interface statistic counters were introduced in Windows Vista and Windows Server 2008. If 64-bit counters are not available, the agent uses 32-bit counters. You may obtain network interface descriptions on Windows with net.if.discovery or net.if.list items.	
net.tcp.listen	Checks if this TCP port is in LISTEN state.	
net.tcp.port	Checks if it is possible to make a TCP connection to the specified port.	
net.tcp.service	Checks if a service is running and accepting TCP connections. Checking of LDAP and HTTPS on Windows is only supported by Zabbix agent 2.	
net.tcp.service.perf	Checks the performance of a TCP service. Checking of LDAP and HTTPS on Windows is only supported by Zabbix agent 2.	
net.tcp.socket.count	Returns the number of TCP sockets that match parameters. This item is supported on Linux by Zabbix agent, but on Windows it is supported only by Zabbix agent 2 on 64-bit Windows.	
net.udp.service	Checks if a service is running and responding to UDP requests.	
net.udp.service.perf	Checks the performance of a UDP service.	
net.udp.socket.count	Returns the number of UDP sockets that match parameters. This item is supported on Linux by Zabbix agent, but on Windows it is supported only by Zabbix agent 2 on 64-bit Windows.	
proc.num	The number of processes. On Windows, only the <code>name</code> and <code>user</code> parameters are supported.	Processes
system.cpu.discovery	The list of detected CPUs/CPU cores.	System
system.cpu.load	The CPU load. When a collector process is started on Zabbix agent, the following performance counters are initialized and later used for this item: <code>\System\Processor Queue Length</code>	
system.cpu.num	The number of CPUs.	
system.cpu.util	The CPU utilization percentage. The value is acquired using the <i>Processor Time</i> performance counter. Note that since Windows 8 its Task Manager shows CPU utilization based on the <i>Processor Utility</i> performance counter, while in previous versions it was the <i>Processor Time</i> counter (see more details). <i>system</i> is the only type parameter supported on Windows.	
system.hostname	The system host name. The value is acquired by either <code>GetComputerName()</code> (for netbios), <code>GetComputerNameExA()</code> (for fqdn), or <code>gethostname()</code> (for host) functions on Windows. See also a more detailed description .	
system.localtime	The system time.	
system.run	Run the specified command on the host.	
system.sw.arch	The software architecture information.	

Item key	Description	Item group
<code>system.swap.size</code>	The swap space size in bytes or in percentage from total. The pused type parameter is supported on Linux by Zabbix agent, but on Windows it is supported only by Zabbix agent 2 . Note that this key might report incorrect swap space size/percentage on virtualized (VMware ESXi, VirtualBox) Windows platforms. In this case you may use the <code>perf_counter[\700(_Total)\702]</code> key to obtain correct swap space percentage.	
<code>system.uname</code>	Identification of the system. On Windows the value for this item is obtained from Win32_OperatingSystem and Win32_Processor WMI classes. The OS name (including edition) might be translated to the user's display language. On some versions of Windows it contains trademark symbols and extra spaces.	
<code>system.uptime</code>	The system uptime in seconds.	
<code>vfs.dir.count</code>	The directory entry count. On Windows, directory symlinks are skipped and hard links are counted only once.	Virtual file systems
<code>vfs.dir.get</code>	The directory entry list. On Windows, directory symlinks are skipped and hard links are counted only once.	
<code>vfs.dir.size</code>	The directory size. On Windows any symlink is skipped and hard links are taken into account only once.	
<code>vfs.file.cksum</code>	The file checksum, calculated by the UNIX cksum algorithm.	
<code>vfs.file.contents</code>	Retrieving the contents of a file.	
<code>vfs.file.exists</code>	Checks if the file exists. On Windows the double quotes have to be backslash <code>'\'</code> escaped and the whole item key enclosed in double quotes when using the command line utility for calling <code>zabbix_get.exe</code> or <code>agent2</code> . Note that the item may turn unsupported on Windows if a directory is searched within a non-existing directory, e.g. <code>vfs.file.exists[C:\no\dir,dir]</code> (where 'no' does not exist).	
<code>vfs.file.get</code>	Returns information about a file. Supported file types on Windows: regular file, directory, symbolic link	
<code>vfs.file.md5sum</code>	The MD5 checksum of file.	
<code>vfs.file.owner</code>	Retrieves the owner of a file.	
<code>vfs.file.regexp</code>	Retrieve a string in the file.	
<code>vfs.file.regmatch</code>	Find a string in the file.	
<code>vfs.file.size</code>	The file size.	
<code>vfs.file.time</code>	The file time information. On Windows XP <code>vfs.file.time[file,change]</code> may be equal to <code>vfs.file.time[file,access]</code> .	
<code>vfs.fs.discovery</code>	The list of mounted filesystems with their type and mount options. The <code>{#FSLABEL}</code> macro is supported on Windows.	
<code>vfs.fs.get</code>	The list of mounted filesystems with their type, available disk space, inode statistics and mount options. The <code>{#FSLABEL}</code> macro is supported on Windows.	
<code>vfs.fs.size</code>	The disk space in bytes or in percentage from total.	
<code>vm.memory.size</code>	The memory size in bytes or in percentage from total.	Virtual memory
<code>web.page.get</code>	Get the content of a web page.	Web monitoring
<code>web.page.perf</code>	The loading time of a full web page.	
<code>web.page.regexp</code>	Find a string on the web page.	
<code>agent.hostmetadata</code>	The agent host metadata.	Zabbix
<code>agent.hostname</code>	The agent host name.	
<code>agent.ping</code>	The agent availability check.	
<code>agent.variant</code>	The variant of Zabbix agent (Zabbix agent or Zabbix agent 2).	
<code>agent.version</code>	The version of Zabbix agent.	
<code>zabbix.stats</code>	Returns a set of Zabbix server or proxy internal metrics remotely.	
<code>zabbix.stats</code>	Returns the number of monitored items in the queue which are delayed on Zabbix server or proxy remotely.	

The table provides details on the item keys that are supported **only** by the Windows Zabbix agent.

Windows-specific items sometimes are an approximate counterpart of a similar agent item, for example `proc_info`, supported on Windows, roughly corresponds to the `proc.mem` item, not supported on Windows.

The item key is a link to full item key details.

Item key	Description	Item group
eventlog	The Windows event log monitoring.	Log monitoring
eventlog.count	The count of lines in the Windows event log.	
net.if.list	The network interface list (includes interface type, status, IPv4 address, description).	Network
perf_counter	The value of any Windows performance counter.	Performance counters
perf_counter_en	The value of any Windows performance counter in English.	
perf_instance.discovery	The list of object instances of Windows performance counters.	
perf_instance_en.discovery	The list of object instances of Windows performance counters, discovered using the object names in English.	
proc_info	Various information about specific process(es).	Processes
registry.data	Return data for the specified value name in the Windows Registry key.	Registry
registry.get	The list of Windows Registry values or keys located at given key.	
service.discovery	The list of Windows services.	Services
service.info	Information about a service.	
services	The listing of services.	
vm.vmemory.size	The virtual memory size in bytes or in percentage from the total.	Virtual memory
wmi.get	Execute a WMI query and return the first selected object.	WMI
wmi.getall	Execute a WMI query and return the whole response.	

Item key details

Parameters without angle brackets are mandatory. Parameters marked with angle brackets `< >` are optional.

`eventlog[name,<regex>,<severity>,<source>,<eventid>,<maxlines>,<mode>]`

`
` The event log monitoring.`
` Return value: *Log*.

Parameters:

- **name** - the name of the event log;`
`
- **regex** - a regular **expression** describing the required pattern (case sensitive);`
`
- **severity** - a regular expression describing severity (case insensitive). This parameter accepts a regular expression based on the following values: "Information", "Warning", "Error", "Critical", "Verbose" (running on Windows Vista or newer).`
`
- **source** - a regular expression describing the source identifier (case insensitive);`
`
- **eventid** - a regular expression describing the event identifier(s) (case sensitive);`
`
- **maxlines** - the maximum number of new lines per second the agent will send to Zabbix server or proxy. This parameter overrides the value of 'MaxLinesPerSecond' in `zabbix_agentd.conf`.`
`
- **mode** - possible values: *all* (default) or *skip* - skip the processing of older data (affects only newly created items).

Comments:

- The item must be configured as an **active check**;
- The agent is unable to send in events from the "Forwarded events" log;
- Windows Eventing 6.0 is supported;
- Selecting a non-Log **type of information** for this item will lead to the loss of local timestamp, as well as log severity and source information;
- See also additional information on **log monitoring**.

Examples:

```
eventlog[Application]
eventlog[Security,,,"Failure Audit",,^(529|680)$]
eventlog[System,,"Warning|Error"]
eventlog[System,,,^1$]
eventlog[System,,,@TWOSHORT] #here a custom regular expression named `TWOSHORT` is referenced (defined as
```

eventlog.count[name,<regexp>,<severity>,<source>,<eventid>,<maxproclines>,<mode>]

 The count of lines in the Windows event log.
 Return value: *Integer*.

Parameters:

- **name** - the name of the event log;

- **regexp** - a regular **expression** describing the required pattern (case sensitive);

- **severity** - a regular expression describing severity (case insensitive). This parameter accepts a regular expression based on the following values: "Information", "Warning", "Error", "Critical", "Verbose" (running on Windows Vista or newer).

- **source** - a regular expression describing the source identifier (case insensitive);

- **eventid** - a regular expression describing the event identifier(s) (case sensitive);

- **maxproclines** - the maximum number of new lines per second the agent will analyze (cannot exceed 10000). The default value is 10*'MaxLinesPerSecond' in **zabbix_agentd.conf**.

- **mode** - possible values: *all* (default) or *skip* - skip the processing of older data (affects only newly created items).

Comments:

- The item must be configured as an **active check**;
- The agent is unable to send in events from the "Forwarded events" log;
- Windows Eventing 6.0 is supported;
- Selecting a non-Log **type of information** for this item will lead to the loss of local timestamp, as well as log severity and source information;
- See also additional information on **log monitoring**.

Example:

```
eventlog.count[System,,"Warning|Error"]
```

```
net.if.list
```

 The network interface list (includes interface type, status, IPv4 address, description).
 Return value: *Text*.

Comments:

- Multi-byte interface names supported;
- Disabled interfaces are not listed;
- Enabling/disabling some components may change their ordering in the Windows interface name;
- Some Windows versions (for example, Server 2008) might require the latest updates installed to support non-ASCII characters in interface names.

```
perf_counter[counter,<interval>]
```

 The value of any Windows performance counter.
 Return value: *Integer, float, string* or *text* (depending on the request).

Parameters:

- **counter** - the path to the counter;

- **interval** - the last N seconds for storing the average value. The `interval` must be between 1 and 900 seconds (included) and the default value is 1.

Comments:

- `interval` is used for counters that require more than one sample (like CPU utilization), so the check returns an average value for last "interval" seconds every time;
- Performance Monitor can be used to obtain the list of available counters.
- See also: **Windows performance counters**.

```
perf_counter_en[counter,<interval>]
```

 The value of any Windows performance counter in English.
 Return value: *Integer, float, string* or *text* (depending on the request).

Parameters:

- **counter** - the path to the counter in English;

- **interval** - the last N seconds for storing the average value. The `interval` must be between 1 and 900 seconds (included) and the default value is 1.

Comments:

- `interval` is used for counters that require more than one sample (like CPU utilization), so the check returns an average value for last "interval" seconds every time;
- This item is only supported on **Windows Server 2008/Vista** and above;

- You can find the list of English strings by viewing the following registry key: `HKEY_LOCAL_MACHINE\SOFTWARE\Microsoft\Windows NT\CurrentVersion\Perflib\009`.

`perf_instance.discovery[object]`

 The list of object instances of Windows performance counters. Used for **low-level discovery**.
 Return value: *JSON object*.

Parameter:

- **object** - the object name (localized).

`perf_instance_en.discovery[object]`

 The list of object instances of Windows performance counters, discovered using the object names in English. Used for **low-level discovery**.
 Return value: *JSON object*.

Parameter:

- **object** - the object name (in English).

`proc_info[process,<attribute>,<type>]`

 Various information about specific process(es).
 Return value: *Float*.

Parameters:

- **process** - the process name;

- **attribute** - the requested process attribute;

- **type** - the representation type (meaningful when more than one process with the same name exists)

Comments:

- The following **attributes** are supported:
vmsize (default) - size of process virtual memory in Kbytes
wkset - size of process working set (amount of physical memory used by process) in Kbytes
pf - number of page faults
ktime - process kernel time in milliseconds
utime - process user time in milliseconds
io_read_b - number of bytes read by process during I/O operations
io_read_op - number of read operation performed by process
io_write_b - number of bytes written by process during I/O operations
io_write_op - number of write operation performed by process
io_other_b - number of bytes transferred by process during operations other than read and write operations
io_other_op - number of I/O operations performed by process, other than read and write operations
gdiobj - number of GDI objects used by process
userobj - number of USER objects used by process;

- Valid **types** are:
avg (default) - average value for all processes named <process>
min - minimum value among all processes named <process>
max - maximum value among all processes named <process>
sum - sum of values for all processes named <process>;
- On a 64-bit system, a 64-bit Zabbix agent is required for this item to work correctly.

Examples:

```
proc_info[iexplore.exe,wkset,sum] #retrieve the amount of physical memory taken by all Internet Explorer p
proc_info[iexplore.exe,pf,avg] #retrieve the average number of page faults for Internet Explorer processes
```

`registry.data[key,<value name>]`

 Return data for the specified value name in the Windows Registry key.
 Return value: *Integer, string or text* (depending on the value type)

Parameters:

- **key** - the registry key including the root key; root abbreviations (e.g. HKLM) are allowed;
- **value name** - the registry value name in the key (empty string "" by default). The default value is returned if the value name is not supplied.

Comments:

- Supported root abbreviations:
HKCR - HKEY_CLASSES_ROOT
HKCC - HKEY_CURRENT_CONFIG
HKCU - HKEY_CURRENT_USER
HKCULS - HKEY_CURRENT_USER_LOCAL_SETTINGS
HKLM - HKEY_LOCAL_MACHINE
HKPD - HKEY_PERFORMANCE_DATA
HKPN - HKEY_PERFORMANCE_NLSTEXT
HKPT - HKEY_PERFORMANCE_TEXT
HKU - HKEY_USERS

- Keys with spaces must be double-quoted.

Examples:

```
registry.data["HKEY_LOCAL_MACHINE\SOFTWARE\Microsoft\Windows\Windows Error Reporting"] #return the data of
registry.data["HKLM\SOFTWARE\Microsoft\Windows\Windows Error Reporting","EnableZip"] #return the data of t
```

registry.get[key,<mode>,<name regexp>]

 The list of Windows Registry values or keys located at given key.
 Return value: *JSON object*.

Parameters:

- **key** - the registry key including the root key; root abbreviations (e.g. HKLM) are allowed (see comments for registry.data[] to see full list of abbreviations);

- **mode** - possible values:
values (default) or *keys*;

- **name regexp** - only discover values with names that match the regexp (default - discover all values). Allowed only with *values* as mode.

Keys with spaces must be double-quoted.

Examples:

```
registry.get [HKLM\SOFTWARE\Microsoft\Windows\CurrentVersion\Uninstall,values,"^DisplayName|DisplayVersion$]
registry.get [HKLM\SOFTWARE\Microsoft\Windows\CurrentVersion\Uninstall,values] #return the data of the all
registry.get [HKLM\SOFTWARE\Microsoft\Windows\CurrentVersion\Uninstall,keys] #return all subkeys of this ke
```

service.discovery

 The list of Windows services. Used for **low-level discovery**.
 Return value: *JSON object*.

service.info[service,<param>]

 Information about a service.
 Return value: *Integer* - with param as *state, startup*; *String* - with param as *displayname, path, user*; *Text* - with param as *description*
Specifically for *state*: 0 - running, 1 - paused, 2 - start pending, 3 - pause pending, 4 - continue pending, 5 - stop pending, 6 - stopped, 7 - unknown, 255 - no such service
Specifically for *startup*: 0 - automatic, 1 - automatic delayed, 2 - manual, 3 - disabled, 4 - unknown, 5 - automatic trigger start, 6 - automatic delayed trigger start, 7 - manual trigger start

Parameters:

- **service** - a real service name or its display name as seen in the MMC Services snap-in;
- **param** - *state* (default), *displayname, path, user, startup, or description*.

Comments:

- Items like `service.info[service,state]` and `service.info[service]` will return the same information;
- Only with param as *state* this item returns a value for non-existing services (255).

Examples:

```
service.info[SNMPTRAP] - state of the SNMPTRAP service;
service.info[SNMP Trap] - state of the same service, but with the display name specified;
service.info[EventLog,startup] - the startup type of the EventLog service
```

services[<type>,<state>,<exclude>]

 The listing of services.
 Return value: *0* - if empty; *Text* - the list of services separated by a newline.

Parameters:

- **type** - *all* (default), *automatic, manual, or disabled*;
- **state** - *all* (default), *stopped, started, start_pending, stop_pending, running, continue_pending, pause_pending, or paused*;
- **exclude** - the services to exclude from the result. Excluded services should be listed in double quotes, separated by comma, without spaces.

Examples:

```
services[,started] #returns the list of started services;
services[automatic, stopped] #returns the list of stopped services that should be running;
services[automatic, stopped, "service1,service2,service3"] #returns the list of stopped services that shou
```

vm.vmemory.size[<type>]

 The virtual memory size in bytes or in percentage from the total.
 Return value: *Integer* - for bytes; *float* - for percentage.

Parameter:

- **type** - possible values: *available* (available virtual memory), *pavailable* (available virtual memory, in percent), *pusd* (used virtual memory, in percent), *total* (total virtual memory, default), or *used* (used virtual memory)

Comments:

- The monitoring of virtual memory statistics is based on:

- Total virtual memory on Windows (total physical + page file size);

- The maximum amount of memory Zabbix agent can commit;

- The current committed memory limit for the system or Zabbix agent, whichever is smaller.

Example:

```
vm.memory.size[pavailable] #return the available virtual memory, in percentage
wmi.get[<namespace>,<query>]
```

 Execute a WMI query and return the first selected object.
 Return value: *Integer, float, string* or *text* (depending on the request).

Parameters:

- **namespace** - the WMI namespace;

- **query** - the WMI query returning a single object.

WMI queries are performed with [WQL](#).

Example:

```
wmi.get[root\cimv2,select status from Win32_DiskDrive where Name like '%PHYSICALDRIVE%'] #returns the sta
wmi.getall[<namespace>,<query>]
```

 Execute a WMI query and return the whole response. Can be used for **low-level discovery**.
 Return value: *JSON object*

Parameters:

- **namespace** - the WMI namespace;

- **query** - the WMI query.

Comments:

- WMI queries are performed with [WQL](#).
- JSONPath **preprocessing** can be used to point to more specific values in the returned JSON.

Example:

```
wmi.getall[root\cimv2,select * from Win32_DiskDrive where Name like '%PHYSICALDRIVE%'] #returns status inf
```

Monitoring Windows services

This tutorial provides step-by-step instructions for setting up the monitoring of Windows services. It is assumed that Zabbix server and agent are configured and operational.

Step 1

Get the service name.

You can get the service name by going to the MMC Services snap-in and bringing up the properties of the service. In the *General* tab you should see a field called "Service name". The value that follows is the name you will use when setting up an item for monitoring. For example, if you wanted to monitor the "workstation" service, then your service might be: **lanmanworkstation**.

Step 2

Configure an item for monitoring the service.

The item `service.info[service,<param>]` retrieves information about a particular service. Depending on the information you need, specify the `param` option which accepts the following values: *displayname*, *state*, *path*, *user*, *startup* or *description*. The default value is *state* if `param` is not specified (`service.info[service]`).

The type of return value depends on chosen `param`: integer for *state* and *startup*; character string for *displayname*, *path* and *user*; text for *description*.

Example:

- **Key:** `service.info[lanmanworkstation]`
- **Type of information:** Numeric (unsigned)

The item `service.info[lanmanworkstation]` will retrieve information about the state of the service as a numerical value. To map a numerical value to a text representation in the frontend ("0" as "Running", "1" as "Paused", etc.), you can configure **value mapping** on the host on which the item is configured. To do this, either **link the template Windows services by Zabbix agent** or **Windows services by Zabbix agent active** to the host, or configure on the host a new value map that is based on the *Windows service state* value map configured on the mentioned templates.

Note that both of the mentioned templates have a discovery rule configured that will discover services automatically. If you do not want this, you can [disable the discovery rule](#) on the host level once the template has been linked to the host.

Discovery of Windows services

[Low-level discovery](#) provides a way to automatically create items, triggers, and graphs for different entities on a computer. Zabbix can automatically start monitoring Windows services on your machine, without the need to know the exact name of a service or create items for each service manually. A filter can be used to generate real items, triggers, and graphs only for services of interest.

2 SNMP agent

Overview

You may want to use SNMP monitoring on devices such as printers, network switches, routers or UPS that usually are SNMP-enabled and on which it would be impractical to attempt setting up complete operating systems and Zabbix agents.

To be able to retrieve data provided by SNMP agents on these devices, Zabbix server must be [initially configured](#) with SNMP support by specifying the `--with-net-snmp` flag. It is recommended to also [install MIB files](#) to ensure that item values are displayed in the correct format. Without the MIB files, formatting issues, such as displaying values in HEX instead of UTF-8 or vice versa, may occur.

SNMP checks are performed over the UDP protocol only.

Zabbix server and proxy daemons log lines similar to the following if they receive an incorrect SNMP response:

```
SNMP response from host "gateway" does not contain all of the requested variable bindings
```

While they do not cover all the problematic cases, they are useful for identifying individual SNMP devices for which combined requests should be disabled.

Zabbix server/proxy will always retry at least one time after an unsuccessful query attempt: either through the SNMP library's retrying mechanism or through the internal [combined processing](#) mechanism.

Warning:

If monitoring SNMPv3 devices, make sure that `msgAuthoritativeEngineID` (also known as `snmpEngineID` or "Engine ID") is never shared by two devices. According to [RFC 2571](#) (section 3.1.1.1) it must be unique for each device.

Warning:

[RFC3414](#) requires the SNMPv3 devices to persist their engineBoots. Some devices do not do that, which results in their SNMP messages being discarded as outdated after being restarted. In such situation, SNMP cache needs to be manually cleared on a server/proxy (by using `-R snmp_cache_reload`) or the server/proxy needs to be restarted.

Configuring SNMP monitoring

To start monitoring a device through SNMP, the following steps have to be performed:

Step 1

Find out the SNMP string (or OID) of the item you want to monitor.

To get a list of SNMP strings, use the `snmpwalk` command (part of [net-snmp](#) software which you should have installed as part of the Zabbix installation) or equivalent tool:

```
snmpwalk -v 2c -c public <host IP> .
```

As '2c' here stands for SNMP version, you may also substitute it with '1', to indicate SNMP Version 1 on the device.

This should give you a list of SNMP strings and their last value. If it doesn't then it is possible that the SNMP 'community' is different from the standard 'public' in which case you will need to find out what it is.

You can then go through the list until you find the string you want to monitor, e.g. if you wanted to monitor the bytes coming in to your switch on port 3 you would use the `IF-MIB::ifHCInOctets.3` string from this line:

```
IF-MIB::ifHCInOctets.3 = Counter64: 3409739121
```

You may now use the `snmpget` command to find out the numeric OID for 'IF-MIB::ifHCInOctets.3':

```
snmpget -v 2c -c public -On <host IP> IF-MIB::ifHCInOctets.3
```

Note that the last number in the string is the port number you are looking to monitor. See also: [Dynamic indexes](#).

This should give you something like the following:

.1.3.6.1.2.1.31.1.1.1.6.3 = Counter64: 3472126941

Again, the last number in the OID is the port number.

Note:

Some of the most used SNMP OIDs are **translated automatically to a numeric representation** by Zabbix.

In the last example above value type is "Counter64", which internally corresponds to ASN_COUNTER64 type. The full list of supported types is ASN_COUNTER, ASN_COUNTER64, ASN_UNSIGNED, ASN_UNSIGNED64, ASN_INTEGER, ASN_INTEGER64, ASN_FLOAT, ASN_DOUBLE, ASN_TIMETICKS, ASN_GAUGE, ASN_IPADDRESS, ASN_OCTET_STR and ASN_OBJECT_ID. These types roughly correspond to "Counter32", "Counter64", "UInteger32", "INTEGER", "Float", "Double", "Timeticks", "Gauge32", "IpAddress", "OCTET STRING", "OBJECT IDENTIFIER" in **snmpget** output, but might also be shown as "STRING", "Hex-STRING", "OID" and other, depending on the presence of a display hint.

Step 2

Create a **host** corresponding to a device.

The screenshot shows the Zabbix Host configuration page. The 'Host' tab is selected. The configuration includes:

- Host name:** SNMP device host
- Visible name:** SNMP device host
- Groups:** Discovered hosts (with a search input field)
- Interfaces:**
 - Agent:** IP address 127.0.0.1
 - SNMP:** IP address 127.0.0.1
- SNMP version:** SNMPv2 (dropdown menu)
- SNMP community:** {\$SNMP_COMMUNITY}
- Max repetition count:** 10 (with a help icon)
- Use combined requests:**

Add an SNMP interface for the host:

- Enter the IP address/DNS name and port number
- Select the *SNMP version* from the dropdown
- Add interface credentials depending on the selected SNMP version:
 - SNMPv1, v2 require only the community (usually 'public')
 - SNMPv3 requires more specific options (see below)
- Specify the max repetition value (default: 10) for **native SNMP bulk requests** (GetBulkRequest-PDUs); only for `discovery []` and `walk []` items in SNMPv2 and v3. Note that setting this value too high may cause the SNMP agent check timeout.
- Mark the *Use combined requests* checkbox to allow **combined processing** of SNMP requests (not related to native SNMP bulk requests "walk" and "get")

SNMPv3 parameter	Description
<i>Context name</i>	Enter context name to identify item on SNMP subnet. User macros are resolved in this field.
<i>Security name</i>	Enter security name. User macros are resolved in this field.
<i>Security level</i>	Select security level: noAuthNoPriv - no authentication nor privacy protocols are used AuthNoPriv - authentication protocol is used, privacy protocol is not AuthPriv - both authentication and privacy protocols are used
<i>Authentication protocol</i>	Select authentication protocol - <i>MD5, SHA1</i> ; with net-snmp 5.8 and newer <i>SHA224, SHA256, SHA384</i> or <i>SHA512</i> .
<i>Authentication passphrase</i>	Enter authentication passphrase. User macros are resolved in this field.
<i>Privacy protocol</i>	Select privacy protocol - <i>DES, AES128, AES192, AES256, AES192C</i> (Cisco) or <i>AES256C</i> (Cisco). See notes about privacy protocol support
<i>Privacy passphrase</i>	Enter privacy passphrase. User macros are resolved in this field.

In case of wrong SNMPv3 credentials (security name, authentication protocol/passphrase, privacy protocol):

- Zabbix receives an ERROR from net-snmp, except for wrong *Privacy passphrase* in which case Zabbix receives a TIMEOUT error from net-snmp;
- SNMP interface availability will switch to red (unavailable).

Warning:

Changes in *Authentication protocol, Authentication passphrase, Privacy protocol* or *Privacy passphrase*, made without changing the *Security name*, will take effect only after the cache on a server/proxy is manually cleared (by using `-R snmp_cache_reload`) or the server/proxy is restarted. In cases, where *Security name* is also changed, all parameters will be updated immediately.

You can use one of the provided SNMP templates that will automatically add a set of items. Before using a template, verify that it is compatible with the host.

Click on *Add* to save the host.

Privacy protocol support

Depending on your operating system and net-snmp configuration, some privacy protocols may not be available:

- On some newer operating systems (for example, RHEL9) support of DES is dropped for the net-snmp package.
- Encryption protocols AES192 and stronger are not supported out-of-the-box on the operating systems older than RHEL 8, CentOS 8, Oracle Linux 8, Debian 12, Ubuntu LTS 22.04, openSUSE Leap 15.5.

To check whether net-snmp library supports AES192+, use one of the following options:

1. `net-snmp-config`:

```
net-snmp-config --configure-options
```

If the output contains `--enable-blumenthal-aes`, AES192+ is supported.

Note that net-snmp-config is part of the development package for SNMP (libsnp-dev for Debian/Ubuntu, net-snmp-devel for CentOS/RHEL/OL/SUSE) and may not be installed by default.

2. `snmpget`:

```
snmpget -v 3 -x AES-256
```

If the output contains `Invalid privacy protocol specified after -3x flag: AES-256`, AES192+ is not supported. If the output contains `No hostname specified.`, AES192+ is not supported.

If your net-snmp library does not support AES192 and higher protocols, recompile net-snmp with `--enable-blumenthal-aes` option, then recompile Zabbix server specifying the option `--with-net-snmp=/home/user/yourcustomnetsnmp/bin/net-snmp-config`

Step 3

Create an item for monitoring.

So, now go back to Zabbix and click on *Items* for the SNMP host you created earlier. Depending on whether you used a template or not when creating your host, you will have either a list of SNMP items associated with your host or just an empty list. We will work on the assumption that you are going to create the item yourself using the information you have just gathered using `snmpwalk` and `snmpget`, so click on *Create item*.

Fill in the required parameters in the new item form:

Item
Tags
Preprocessing

*** Name**

Interface wlp3s0: Bits received

Type

SNMP agent ▼

*** Key**

net.if.in[ifHCInOctets.3]

Type of information

Numeric (unsigned) ▼

*** Host interface**

127.0.0.1:161 ▼

*** SNMP OID** ?

get[1.3.6.1.2.1.31.1.1.1.6.3]

Units

bps

*** Update interval**

3m

Parameter	Description
<i>Name</i>	Enter the item name.
<i>Type</i>	Select SNMP agent here.
<i>Key</i>	Enter the key as something meaningful.
<i>Host interface</i>	Make sure to select the SNMP interface, e.g. of your switch/router.

Parameter	Description
<i>SNMP OID</i>	<p>Use one of the supported formats to enter OID value(s):</p> <p>walk[OID1,OID2,...] - retrieve a subtree of values. For example: <code>walk[1.3.6.1.2.1.2.2.1.2,1.3.6.1.2.1.2.2.1.3]</code>. This option makes use of native SNMP bulk requests (GetBulkRequest-PDUs) asynchronously. The timeout settings for this item can be set in the item configuration form. You may use this as the master item, with dependent items that extract data from the master using preprocessing. It is possible to specify multiple OIDs in a single snmp walk, such as <code>walk[OID1,OID2,...]</code> to asynchronously process one OID at a time. If the bulk request returns no results then it is attempted to retrieve a single record without bulk request. MIB names are supported as parameters; thus <code>walk[1.3.6.1.2.1.2.2.1.2]</code> and <code>walk[ifDescr]</code> will return the same output. If several OIDs/MIBs are specified, i.e. <code>walk[ifDescr,ifType,ifPhysAddress]</code>, then the output is a concatenated list. GetBulk requests are used with SNMPv2 and v3 interfaces and GetNext for SNMPv1 interfaces; max repetitions for bulk requests are configured on the interface level. This item returns the output of the snmpwalk utility with <code>-Oe -Ot -On</code> parameters. You may use this item as a master item in SNMP discovery.</p> <p>get[OID] - retrieve a <i>single</i> value asynchronously. For example: <code>get[1.3.6.1.2.1.31.1.1.1.6.3]</code> The timeout settings for this item can be set in the item configuration form.</p> <p>OID - (legacy) enter a single textual or numeric OID to retrieve a single value synchronously, optionally combined with other values. For example: <code>1.3.6.1.2.1.31.1.1.1.6.3</code>. For this option, the item check timeout will be equal to the value set in the server configuration file.</p> <p>It is recommended to use <code>walk[OID]</code> and <code>get [OID]</code> items for better performance. All <code>walk[OID]</code> and <code>get [OID]</code> items are executed asynchronously - it is not required to receive the response to one request before other checks are started. DNS resolving is asynchronous as well. The maximum concurrency of asynchronous checks is 1000 (defined by MaxConcurrentChecksPerPoller). The number of asynchronous SNMP pollers is defined by the StartSNMPPollers parameter.</p> <p>Note that for network traffic statistics, returned by any of the methods, a <i>Change per second</i> step must be added in the <i>Preprocessing</i> tab; otherwise you will get the cumulative value from the SNMP device instead of the latest change.</p>

All mandatory input fields are marked with a red asterisk.

Now save the item and go to *Monitoring* → *Latest data* for your SNMP data.

Example 1

General example:

Parameter	Description
OID	1.2.3.45.6.7.8.0 (or .1.2.3.45.6.7.8.0)
Key	<Unique string to be used as reference to triggers> For example, "my_param".

Note that OID can be given in either numeric or string form. However, in some cases, string OID must be converted to numeric representation. Utility snmpget may be used for this purpose:

```
snmpget -On localhost public enterprises.ucdavis.memory.memTotalSwap.0
```

Example 2

Monitoring of uptime:

Parameter	Description
OID	MIB::sysUpTime.0
Key	router.uptime
Value type	Float
Units	uptime
Preprocessing step: Custom multiplier	0.01

Native SNMP bulk requests

The **walk[OID1,OID2,...]** item allows to use native SNMP functionality for bulk requests (GetBulkRequest-PDUs), available in SNMP versions 2/3.

A GetBulk request in SNMP executes multiple GetNext requests and returns the result in a single response. This may be used for regular SNMP items as well as for SNMP discovery to minimize network roundtrips.

The SNMP **walk[OID1,OID2,...]** item may be used as the master item that collects data in one request with dependent items that parse the response as needed using preprocessing.

Note that using native SNMP bulk requests is not related to the option of combining SNMP requests, which is Zabbix own way of combining multiple SNMP requests (see next section).

A retry will occur for SNMP bulk items to avoid failure if one of the packets is lost. The timeout for SNMP items with `get` and `walk` is set for whole session. If the timeout is reached then a retry will occur one time, the timeout will be reset and the last request will be resent allowing to continue the session from last request if a single packet is lost or arrived too late.

Internal workings of combined processing

Zabbix server and proxy may query SNMP devices for multiple values in a single request. This affects several types of SNMP items:

- regular SNMP items
- SNMP items with dynamic indexes
- SNMP low-level discovery rules

All SNMP items on a single interface with identical parameters are scheduled to be queried at the same time. The first two types of items are taken by pollers in batches of at most 128 items, whereas low-level discovery rules are processed individually, as before.

On the lower level, there are two kinds of operations performed for querying values: getting multiple specified objects and walking an OID tree.

For "getting", a GetRequest-PDU is used with at most 128 variable bindings. For "walking", a GetNextRequest-PDU is used for SNMPv1 and GetBulkRequest with "max-repetitions" field of at most 128 is used for SNMPv2 and SNMPv3.

Thus, the benefits of combined processing for each SNMP item type are outlined below:

- regular SNMP items benefit from "getting" improvements;
- SNMP items with dynamic indexes benefit from both "getting" and "walking" improvements: "getting" is used for index verification and "walking" for building the cache;
- SNMP low-level discovery rules benefit from "walking" improvements.

However, there is a technical issue that not all devices are capable of returning 128 values per request. Some always return a proper response, but others either respond with a "tooBig(1)" error or do not respond at all once the potential response is over a certain limit.

In order to find an optimal number of objects to query for a given device, Zabbix uses the following strategy. It starts cautiously with querying 1 value in a request. If that is successful, it queries 2 values in a request. If that is successful again, it queries 3 values in a request and continues similarly by multiplying the number of queried objects by 1.5, resulting in the following sequence of request sizes: 1, 2, 3, 4, 6, 9, 13, 19, 28, 42, 63, 94, 128.

However, once a device refuses to give a proper response (for example, for 42 variables), Zabbix does two things.

First, for the current item batch it halves the number of objects in a single request and queries 21 variables. If the device is alive, then the query should work in the vast majority of cases, because 28 variables were known to work and 21 is significantly less than that. However, if that still fails, then Zabbix falls back to querying values one by one. If it still fails at this point, then the device is definitely not responding and request size is not an issue.

The second thing Zabbix does for subsequent item batches is it starts with the last successful number of variables (28 in our example) and continues incrementing request sizes by 1 until the limit is hit. For example, assuming the largest response size is 32 variables, the subsequent requests will be of sizes 29, 30, 31, 32, and 33. The last request will fail and Zabbix will never issue a request of size 33 again. From that point on, Zabbix will query at most 32 variables for this device.

If large queries fail with this number of variables, it can mean one of two things. The exact criteria that a device uses for limiting response size cannot be known, but we try to approximate that using the number of variables. So the first possibility is that this number of variables is around the device's actual response size limit in the general case: sometimes response is less than the limit, sometimes it is greater than that. The second possibility is that a UDP packet in either direction simply got lost. For these reasons, if Zabbix gets a failed query, it reduces the maximum number of variables to try to get deeper into the device's comfortable range, but only up to two times.

In the example above, if a query with 32 variables happens to fail, Zabbix will reduce the count to 31. If that happens to fail, too, Zabbix will reduce the count to 30. However, Zabbix will not reduce the count below 30, because it will assume that further failures are due to UDP packets getting lost, rather than the device's limit.

If, however, a device cannot handle combined requests properly for other reasons and the heuristic described above does not work, there is a "Use combined requests" setting for each interface that allows to disable combined requests for that device.

1 Dynamic indexes

Overview

While you may find the required index number (for example, of a network interface) among the SNMP OIDs, sometimes you may not completely rely on the index number always staying the same.

Index numbers may be dynamic - they may change over time and your item may stop working as a consequence.

To avoid this scenario, it is possible to define an OID which takes into account the possibility of an index number changing.

For example, if you need to retrieve the index value to append to **ifInOctets** that corresponds to the **GigabitEthernet0/1** interface on a Cisco device, use the following OID:

```
ifInOctets["index","ifDescr","GigabitEthernet0/1"]
```

The syntax

A special syntax for OID is used:

<OID of data>["index", "<base OID of index>", "<string to search for>"]

Parameter	Description
OID of data	Main OID to use for data retrieval on the item.
index	Method of processing. Currently one method is supported: index - search for index and append it to the data OID
base OID of index	This OID will be looked up to get the index value corresponding to the string.
string to search for	The string to use for an exact match with a value when doing lookup. Case sensitive.

Example

Getting memory usage of *apache* process.

If using this OID syntax:

```
HOST-RESOURCES-MIB::hrSWRunPerfMem["index", "HOST-RESOURCES-MIB::hrSWRunPath", "/usr/sbin/apache2"]
```

the index number will be looked up here:

```
...
HOST-RESOURCES-MIB::hrSWRunPath.5376 = STRING: "/sbin/getty"
HOST-RESOURCES-MIB::hrSWRunPath.5377 = STRING: "/sbin/getty"
HOST-RESOURCES-MIB::hrSWRunPath.5388 = STRING: "/usr/sbin/apache2"
HOST-RESOURCES-MIB::hrSWRunPath.5389 = STRING: "/sbin/sshd"
...
```

Now we have the index, 5388. The index will be appended to the data OID in order to receive the value we are interested in:

```
HOST-RESOURCES-MIB::hrSWRunPerfMem.5388 = INTEGER: 31468 KBytes
```

Index lookup caching

When a dynamic index item is requested, Zabbix retrieves and caches whole SNMP table under base OID for index, even if a match would be found sooner. This is done in case another item would refer to the same base OID later - Zabbix would look up index in the cache, instead of querying the monitored host again. Note that each poller process uses separate cache.

In all subsequent value retrieval operations only the found index is verified. If it has not changed, value is requested. If it has changed, cache is rebuilt - each poller that encounters a changed index walks the index SNMP table again.

2 Special OIDs

Some of the most used SNMP OIDs are translated automatically to a numeric representation by Zabbix. For example, **ifIndex** is translated to **1.3.6.1.2.1.2.2.1.1**, **ifIndex.0** is translated to **1.3.6.1.2.1.2.2.1.1.0**.

The table contains list of the special OIDs.

Special OID	Identifier	Description
ifIndex	1.3.6.1.2.1.2.2.1.1	A unique value for each interface.
ifDescr	1.3.6.1.2.1.2.2.1.2	A textual string containing information about the interface. This string should include the name of the manufacturer, the product name and the version of the hardware interface.
ifType	1.3.6.1.2.1.2.2.1.3	The type of interface, distinguished according to the physical/link protocol(s) immediately 'below' the network layer in the protocol stack.
ifMtu	1.3.6.1.2.1.2.2.1.4	The size of the largest datagram which can be sent / received on the interface, specified in octets.
ifSpeed	1.3.6.1.2.1.2.2.1.5	An estimate of the interface's current bandwidth in bits per second.
ifPhysAddress	1.3.6.1.2.1.2.2.1.6	The interface's address at the protocol layer immediately 'below' the network layer in the protocol stack.
ifAdminStatus	1.3.6.1.2.1.2.2.1.7	The current administrative state of the interface.
ifOperStatus	1.3.6.1.2.1.2.2.1.8	The current operational state of the interface.
ifInOctets	1.3.6.1.2.1.2.2.1.10	The total number of octets received on the interface, including framing characters.
ifInUcastPkts	1.3.6.1.2.1.2.2.1.11	The number of subnetwork-unicast packets delivered to a higher-layer protocol.
ifInNUcastPkts	1.3.6.1.2.1.2.2.1.12	The number of non-unicast (i.e., subnetwork- broadcast or subnetwork-multicast) packets delivered to a higher-layer protocol.
ifInDiscards	1.3.6.1.2.1.2.2.1.13	The number of inbound packets which were chosen to be discarded even though no errors had been detected to prevent their being deliverable to a higher-layer protocol. One possible reason for discarding such a packet could be to free up buffer space.
ifInErrors	1.3.6.1.2.1.2.2.1.14	The number of inbound packets that contained errors preventing them from being deliverable to a higher-layer protocol.
ifInUnknownProtos	1.3.6.1.2.1.2.2.1.15	The number of packets received via the interface which were discarded because of an unknown or unsupported protocol.
ifOutOctets	1.3.6.1.2.1.2.2.1.16	The total number of octets transmitted out of the interface, including framing characters.
ifOutUcastPkts	1.3.6.1.2.1.2.2.1.17	The total number of packets that higher-level protocols requested be transmitted, and which were not addressed to a multicast or broadcast address at this sub-layer, including those that were discarded or not sent.
ifOutNUcastPkts	1.3.6.1.2.1.2.2.1.18	The total number of packets that higher-level protocols requested be transmitted, and which were addressed to a multicast or broadcast address at this sub-layer, including those that were discarded or not sent.
ifOutDiscards	1.3.6.1.2.1.2.2.1.19	The number of outbound packets which were chosen to be discarded even though no errors had been detected to prevent their being transmitted. One possible reason for discarding such a packet could be to free up buffer space.
ifOutErrors	1.3.6.1.2.1.2.2.1.20	The number of outbound packets that could not be transmitted because of errors.
ifOutQLen	1.3.6.1.2.1.2.2.1.21	The length of the output packet queue (in packets).

3 MIB files

MIB stands for the Management Information Base. MIB files allow to use textual representation of an OID (Object Identifier). It is possible to use raw OIDs when monitoring SNMP devices with Zabbix, but if you feel more comfortable using textual representation, you need to install MIB files.

For example,

```
ifHCOutOctets
```

is textual representation of the OID

```
1.3.6.1.2.1.31.1.1.1.10
```

Installing MIB files

On Debian-based systems:

```
apt install snmp-mibs-downloader
download-mibs
```

On RedHat-based systems:

```
dnf install net-snmp-libs
```

Enabling MIB files

On RedHat-based systems, MIB files should be enabled by default. On Debian-based systems, you have to edit the file `/etc/snmp/snmp.conf` and comment out the line that says `mibs :`

```
# As the snmp packages come without MIB files due to license reasons, loading
# of MIBs is disabled by default. If you added the MIBs you can re-enable
# loading them by commenting out the following line.
mibs :
```

Testing MIB files

Testing SNMP MIBs can be done using `snmpwalk` utility. If you don't have it installed, use the following instructions.

On Debian-based systems:

```
apt install snmp
```

On RedHat-based systems:

```
dnf install net-snmp-utils
```

After that, the following command must not give error when you query a network device:

```
$ snmpwalk -v 2c -c public <NETWORK DEVICE IP> ifInOctets
IF-MIB::ifInOctets.1 = Counter32: 176137634
IF-MIB::ifInOctets.2 = Counter32: 0
IF-MIB::ifInOctets.3 = Counter32: 240375057
IF-MIB::ifInOctets.4 = Counter32: 220893420
[...]
```

Using MIBs in Zabbix

The most important to keep in mind is that Zabbix processes do not get informed of the changes made to MIB files. So after every change you must restart Zabbix server or proxy, e. g.:

```
systemctl restart zabbix-server
```

After that, the changes made to MIB files are in effect.

Using custom MIB files

There are standard MIB files coming with every GNU/Linux distribution. But some device vendors provide their own.

Let's say, you would like to use **CISCO-SMI** MIB file. The following instructions will download and install it:

```
wget ftp://ftp.cisco.com/pub/mibs/v2/CISCO-SMI.my -P /tmp
mkdir -p /usr/local/share/snmp/mibs
grep -q '^mibdirs +/usr/local/share/snmp/mibs' /etc/snmp/snmp.conf 2>/dev/null || echo "mibdirs +/usr/local/share/snmp/mibs" >>/etc/snmp/snmp.conf
cp /tmp/CISCO-SMI.my /usr/local/share/snmp/mibs
```

Now you should be able to use it. Try to translate the name of the object `ciscoProducts` from the MIB file to OID:

```
snmptranslate -IR -On CISCO-SMI::ciscoProducts
.1.3.6.1.4.1.9.1
```

If you receive errors instead of the OID, ensure all the previous commands did not return any errors.

The object name translation worked, you are ready to use custom MIB file. Note the MIB name prefix (*CISCO-SMI::*) used in the query. You will need this when using command-line tools as well as Zabbix.

Don't forget to restart Zabbix server/proxy before using this MIB file in Zabbix.

Attention:

Keep in mind that MIB files can have dependencies. That is, one MIB may require another. In order to satisfy these dependencies you have to install all the affected MIB files.

3 SNMP traps

Overview

Receiving SNMP traps is the opposite to querying SNMP-enabled devices.

In this case, the information is sent from an SNMP-enabled device to `snmptrapd` and is collected or "trapped" by Zabbix server or Zabbix proxy from file.

Usually, traps are sent upon some condition change and the agent connects to the server on port 162 (as opposed to port 161 on the agent side that is used for queries). Using traps may detect some short problems that occur amidst the query interval and may be missed by the query data.

Receiving SNMP traps in Zabbix is designed to work with **snmptrapd** and one of the mechanisms for passing the traps to Zabbix - either a Bash or Perl script or SNMPPTT.

Note:

The simplest way to set up trap monitoring after configuring Zabbix is to use the Bash script solution, because Perl and SNMPPTT are often missing in modern distributions and require more complex configuration. However, this solution uses a script configured as `traphandle`. For better performance on production systems, use the embedded Perl solution (either script with `do perl` option or SNMPPTT).

The workflow of receiving a trap:

1. `snmptrapd` receives a trap
2. `snmptrapd` passes the trap to the receiver script (Bash, Perl) or SNMPPTT
3. The receiver parses, formats and writes the trap to a file
4. Zabbix SNMP trapper reads and parses the trap file
5. For each trap Zabbix finds all "SNMP trapper" items with host interfaces matching the received trap address. Note that only the selected "IP" or "DNS" in host interface is used during the matching.
6. For each found item, the trap is compared to `regex` in `snmptrap[regex]`. The trap is set as the value of **all** matched items. If no matching item is found and there is an `snmptrap.fallback` item, the trap is set as the value of that.
7. If the trap was not set as the value of any item, Zabbix by default logs the unmatched trap. (This is configured by "Log unmatched SNMP traps" in Administration → General → Other.)

Notes on HA failover

During high-availability (HA) node switch, Zabbix will continue processing after the last record within the last ISO 8601 timestamp; if the same record is not found then only the timestamp will be used to identify last position.

Configuring SNMP traps

Configuring the following fields in the frontend is specific for this item type:

- Your host must have an SNMP interface

In *Data collection* → *Hosts*, in the **Host interface** field set an SNMP interface with the correct IP or DNS address. The address from each received trap is compared to the IP and DNS addresses of all SNMP interfaces to find the corresponding hosts.

- Configure the item with SNMP trap type

In the **Key** field use one of the SNMP trap keys:

Key	Description	Return value	Comments
	snmptrap [regex]		

Key

Catches all SNMP traps that match the **regular expression** specified in **regexp**. If regexp is unspecified, catches any trap.

SNMP trap

This item can be set only for SNMP interfaces. User macros and global regular expressions are supported in the parameter of this item key.

snmptrap.fallback

Catches all SNMP traps that were not caught by any of the snmptrap[] items for that interface.

SNMP trap

This item can be set only for SNMP interfaces.

Note:

Multiline regular expression matching is not supported at this time.

Set the **Type of information** to 'Log' for the timestamps to be parsed. Note that other formats such as 'Numeric' are also acceptable but might require a custom trap handler.

Note:

For SNMP trap monitoring to work, it must first be set up correctly (see below).

Setting up SNMP trap monitoring

Configuring Zabbix server/proxy

To read the traps, Zabbix server or proxy must be configured to start the SNMP trapper process and point to the trap file that is being written by SNMPTT or a Bash/Perl trap receiver. To do that, edit the configuration file (`zabbix_server.conf` or `zabbix_proxy.conf`):

```
StartSNMPTrapper=1
SNMPTrapperFile=[TRAP FILE]
```

Warning:

If systemd parameter **PrivateTmp** is used, this file is unlikely to work in `/tmp`.

Configuring Bash trap receiver

Requirements: only snmptrapd.

A Bash trap receiver [script](#) can be used to pass traps to Zabbix server from snmptrapd using trapper file. To configure it, add the `traphandle` option to snmptrapd configuration file (`snmptrapd.conf`), see [example](#).

Note:

snmptrapd might need to be restarted to pick up changes to its configuration.

Configuring Perl trap receiver

Requirements: Perl, Net-SNMP compiled with `--enable-embedded-perl` (done by default since Net-SNMP 5.4)

A Perl trap receiver (look for `misc/snmptrap/zabbix_trap_receiver.pl`) can be used to pass traps to Zabbix server directly from snmptrapd. To configure it:

- add the Perl script to the snmptrapd configuration file (`snmptrapd.conf`), e.g.:

```
perl do "[FULL PATH TO PERL RECEIVER SCRIPT]";
```

- configure the receiver, e.g:

```
$SNMPTrapperFile = '[TRAP FILE]';
$DateTimeFormat = '[DATE TIME FORMAT]';
```

Note:

snmptrapd might need to be restarted to pick up changes to its configuration.

Note:

If the script name is not quoted, snmptrapd will refuse to start up with messages, similar to these:

```
Regexp modifiers "/l" and "/a" are mutually exclusive at (eval 2) line 1, at end of line
Regexp modifier "/l" may not appear twice at (eval 2) line 1, at end of line
```

Configuring SNMPPTT

At first, snmptrapd should be configured to use SNMPPTT.

Note:

For the best performance, SNMPPTT should be configured as a daemon using **snmpthandler-embedded** to pass the traps to it. See instructions for [configuring SNMPPTT](#).

When SNMPPTT is configured to receive the traps, configure `snmptt.ini`:

1. enable the use of the Perl module from the NET-SNMP package:

```
net_snmp_perl_enable = 1
```

2. log traps to the trap file which will be read by Zabbix:

```
log_enable = 1
log_file = [TRAP FILE]
```

3. set the date-time format:

```
date_time_format = %Y-%m-%dT%H:%M:%S%z
```

Warning:

The "net-snmp-perl" package has been removed in RHEL 8.0-8.2; re-added in RHEL 8.3. For more information, see the [known issues](#).

Now format the traps for Zabbix to recognize them (edit `snmptt.conf`):

1. Each FORMAT statement should start with "ZBXTRAP [address]", where [address] will be compared to IP and DNS addresses of SNMP interfaces on Zabbix. E.g.:

```
EVENT coldStart .1.3.6.1.6.3.1.1.5.1 "Status Events" Normal
FORMAT ZBXTRAP $aA Device reinitialized (coldStart)
```

2. See more about SNMP trap format below.

Attention:

Do not use unknown traps - Zabbix will not be able to recognize them. Unknown traps can be handled by defining a general event in `snmptt.conf`:

```
EVENT general .* "General event" Normal
```

SNMP trap format

All customized Perl trap receivers and SNMPPTT trap configuration must format the trap in the following way:

```
[timestamp] [the trap, part 1] ZBXTRAP [address] [the trap, part 2]
```

where

- [timestamp] - the timestamp in "%Y-%m-%dT%H:%M:%S%z" format
- ZBXTRAP - header that indicates that a new trap starts in this line
- [address] - IP address used to find the host for this trap

Note that "ZBXTRAP" and "[address]" will be cut out from the message during processing. If the trap is formatted otherwise, Zabbix might parse the traps unexpectedly.

Example trap:

```
2024-01-11T15:28:47+0200 .1.3.6.1.6.3.1.1.5.3 Normal "Status Events" localhost - ZBXTRAP 192.168.1.1 Link
```

This will result in the following trap for SNMP interface with IP=192.168.1.1:

```
2024-01-11T15:28:47+0200 .1.3.6.1.6.3.1.1.5.3 Normal "Status Events"
localhost - Link down on interface 2. Admin state: 1. Operational state: 2
```

System requirements

Large file support

Zabbix has large file support for SNMP trapper files. The maximum file size that Zabbix can read is 2^{63} (8 EiB). Note that the filesystem may impose a lower limit on the file size.

Log rotation

Zabbix does not provide any log rotation system - that should be handled by the user. The log rotation should first rename the old file and only later delete it so that no traps are lost:

1. Zabbix opens the trap file at the last known location and goes to step 3
2. Zabbix checks if the currently opened file has been rotated by comparing the inode number to the defined trap file's inode number. If there is no opened file, Zabbix resets the last location and goes to step 1.
3. Zabbix reads the data from the currently opened file and sets the new location.
4. The new data are parsed. If this was the rotated file, the file is closed and goes back to step 2.
5. If there was no new data, Zabbix sleeps for 1 second and goes back to step 2.

File system

Because of the trap file implementation, Zabbix needs the file system to support inodes to differentiate files (the information is acquired by a `stat()` call).

Setup examples using different SNMP protocol versions

This example uses `snmptrapd` and a Bash receiver script to pass traps to Zabbix server.

Setup:

1. Configure Zabbix to start SNMP trapper and set the trap file. Add to `zabbix_server.conf`:

```
StartSNMPTrapper=1
SNMPTrapperFile=/var/lib/zabbix/snmptraps/snmptraps.log
```

2. Download the Bash script to `/usr/sbin/zabbix_trap_handler.sh`:

```
curl -o /usr/sbin/zabbix_trap_handler.sh https://raw.githubusercontent.com/zabbix/zabbix-docker/trunk/Docker
```

If necessary, adjust the `ZABBIX_TRAPS_FILE` variable in the script. To use the default value, create the parent directory first:

```
mkdir -p /var/lib/zabbix/snmptraps
```

3. Add the following to `snmptrapd.conf` (refer to working [example](#))

```
traphandle default /bin/bash /usr/sbin/zabbix_trap_handler.sh
```

Note:

`snmptrapd` might need to be restarted to pick up changes to its configuration.

4. Create an SNMP item for testing purposes:

```
Host SNMP interface IP: 127.0.0.1
Key: snmptrap["linkUp"]
Log time format: yyyy-MM-ddThh:mm:ss
```

Note that the ISO 8601 date and time format is used.

5. Next we will configure `snmptrapd` for our chosen SNMP protocol version and send test traps using the `snmptrap` utility.

SNMPv1, SNMPv2

SNMPv1 and SNMPv2 protocols rely on "community string" authentication. In the example below we will use "secret" as community string. It must be set to the same value on SNMP trap senders.

Please note that while still widely used in production environments, SNMPv2 doesn't offer any encryption and real sender authentication. The data is sent as plain text and therefore these protocol versions should only be used in secure environments such as private network and should never be used over any public or third-party network.

SNMP version 1 isn't really used these days since it doesn't support 64-bit counters and is considered a legacy protocol.

To enable accepting SNMPv1 or SNMPv2 traps you should add the following line to `snmptrapd.conf`. Replace "secret" with the SNMP community string configured on SNMP trap senders:

```
authCommunity log,execute,net secret
```

Next we can send a test trap using `snmptrap`. We will use the common "link up" OID in this example:

```
snmptrap -v 2c -c secret localhost '' linkUp.0
```

SNMPv3

SNMPv3 addresses SNMPv1/v2 security issues and provides authentication and encryption. You can use the MD5 or multiple SHA authentication methods and DES/multiple AES as cipher.

To enable accepting SNMPv3 add the following lines to `snmptrapd.conf`:

```
createUser -e 0x8000000001020304 traptest SHA mypassword AES
authuser log,execute traptest
```

Attention:

Please note the "execute" keyword that allows to execute scripts for this user security model.

```
snmptrap -v 3 -n "" -a SHA -A mypassword -x AES -X mypassword -l authPriv -u traptest -e 0x8000000001020304
```

Warning:

If you wish to use strong encryption methods such as AES192 or AES256, please use `net-snmp` starting with version 5.8. You might have to recompile it with `configure` option: `--enable-blumenthal-aes`. Older versions of `net-snmp` do not support AES192/AES256. See also: http://www.net-snmp.org/wiki/index.php/Strong_Authentication_or_Encryption

Verification

In both examples you will see similar lines in your `/var/lib/zabbix/snmptraps/snmptraps.log`:

```
2024-01-30T10:04:23+0200 ZBXTRAP 127.0.0.1
UDP: [127.0.0.1]:56585->[127.0.0.1]:162
DISMAN-EVENT-MIB::sysUpTimeInstance = 2538834
SNMPv2-MIB::snmpTrapOID.0 = IF-MIB::linkUp.0
```

The item value in Zabbix will be:

```
2024-01-30 10:04:23 2024-01-30 10:04:21
```

```
2024-01-30T10:04:21+0200 UDP: [127.0.0.1]:56585->[127.0.0.1]:162
DISMAN-EVENT-MIB::sysUpTimeInstance = 2538834
SNMPv2-MIB::snmpTrapOID.0 = IF-MIB::linkUp.0
```

Example with Perl:

```
2024-01-30T11:42:54+0200 ZBXTRAP 127.0.0.1
```

PDU INFO:

```
receivedfrom          UDP: [127.0.0.1]:58649->[127.0.0.1]:162
notificationtype      TRAP
version                1
community              public
errorstatus            0
transactionid         1
requestid              2101882550
messageid              0
errorindex             0
```

VARBINDS:

```
DISMAN-EVENT-MIB::sysUpTimeInstance type=67 value=Timeticks: (457671) 1:16:16.71
SNMPv2-MIB::snmpTrapOID.0          type=6 value=OID: IF-MIB::linkUp.0
```

See also

- [Zabbix blog article on SNMP traps](#)
- [Configuring snmptrapd \(official net-snmp documentation\)](#)

- [Configuring snmptrapd to receive SNMPv3 notifications \(official net-snmp documentation\)](#)

4 IPMI checks

Overview

You can monitor the health and availability of Intelligent Platform Management Interface (IPMI) devices in Zabbix. To perform IPMI checks Zabbix server must be initially **configured** with IPMI support.

IPMI is a standardized interface for remote "lights-out" or "out-of-band" management of computer systems. It allows to monitor hardware status directly from the so-called "out-of-band" management cards, independently from the operating system or whether the machine is powered on at all.

Zabbix IPMI monitoring works only for devices having IPMI support (HP iLO, DELL DRAC, IBM RSA, Sun SSP, etc).

An IPMI manager process schedules the IPMI checks by IPMI pollers. A host is always polled by only one IPMI poller at a time, reducing the number of open connections to BMC controllers. Thus it's safe to increase the number of IPMI pollers without worrying about BMC controller overloading. The IPMI manager process is automatically started when at least one IPMI poller is started.

See also **known issues** for IPMI checks.

Configuration

Host configuration

A host must be configured to process IPMI checks. An IPMI interface must be added, with the respective IP and port numbers, and IPMI authentication parameters must be defined.

See the **configuration of hosts** for more details.

Server configuration

By default, the Zabbix server is not configured to start any IPMI pollers, thus any added IPMI items won't work. To change this, open the Zabbix server configuration file (**zabbix_server.conf**) as root and look for the following line:

```
# StartIPMIPollers=0
```

Uncomment it and set poller count to, say, 3, so that it reads:

```
StartIPMIPollers=3
```

Save the file and restart `zabbix_server` afterwards.

Item configuration

When **configuring an item** on a host level:

- Select 'IPMI agent' as the *Type*
- Enter an item **key** that is unique within the host (say, `ipmi.fan.rpm`)
- For *Host interface* select the relevant IPMI interface (IP and port). Note that an IPMI interface must exist on the host.
- Specify the *IPMI sensor* (for example 'FAN MOD 1A RPM' on Dell Poweredge) to retrieve the metric from. By default, the sensor ID should be specified. It is also possible to use prefixes before the value:
 - `id:` - to specify sensor ID;
 - `name:` - to specify sensor full name. This can be useful in situations when sensors can only be distinguished by specifying the full name.
- Select the respective type of information ('Numeric (float)' in this case; for discrete sensors - 'Numeric (unsigned)'), units (most likely 'rpm') and any other required item attributes

Supported checks

IPMI agent supports the built-in item **ipmi.get**, which returns IPMI-sensor related information and can be used for the **discovery of IPMI sensors**.

Return value: *JSON object*

Timeout and session termination

IPMI message timeouts and retry counts are defined in OpenIPMI library. Due to the current design of OpenIPMI, it is not possible to make these values configurable in Zabbix, neither on interface nor item level.

IPMI session inactivity timeout for LAN is 60 +/-3 seconds. Currently it is not possible to implement periodic sending of Activate Session command with OpenIPMI. If there are no IPMI item checks from Zabbix to a particular BMC for more than the session timeout configured in BMC then the next IPMI check after the timeout expires will time out due to individual message timeouts, retries or receive error. After that a new session is opened and a full rescan of the BMC is initiated. If you want to avoid unnecessary rescans of the BMC it is advised to set the IPMI item polling interval below the IPMI session inactivity timeout configured in BMC.

Notes on IPMI discrete sensors

To find sensors on a host start Zabbix server with **DebugLevel=4** enabled. Wait a few minutes and find sensor discovery records in Zabbix server logfile:

```
$ grep 'Added sensor' zabbix_server.log
8358:20130318:111122.170 Added sensor: host:'192.168.1.12:623' id_type:0 id_sz:7 id:'CATERR' reading_type:
8358:20130318:111122.170 Added sensor: host:'192.168.1.12:623' id_type:0 id_sz:15 id:'CPU Therm Trip' read
8358:20130318:111122.171 Added sensor: host:'192.168.1.12:623' id_type:0 id_sz:17 id:'System Event Log' re
8358:20130318:111122.171 Added sensor: host:'192.168.1.12:623' id_type:0 id_sz:17 id:'PhysicalSecurity' re
8358:20130318:111122.171 Added sensor: host:'192.168.1.12:623' id_type:0 id_sz:14 id:'IPMI Watchdog' readi
8358:20130318:111122.171 Added sensor: host:'192.168.1.12:623' id_type:0 id_sz:16 id:'Power Unit Stat' rea
8358:20130318:111122.171 Added sensor: host:'192.168.1.12:623' id_type:0 id_sz:16 id:'P1 Therm Ctrl %' rea
8358:20130318:111122.172 Added sensor: host:'192.168.1.12:623' id_type:0 id_sz:16 id:'P1 Therm Margin' rea
8358:20130318:111122.172 Added sensor: host:'192.168.1.12:623' id_type:0 id_sz:13 id:'System Fan 2' readin
8358:20130318:111122.172 Added sensor: host:'192.168.1.12:623' id_type:0 id_sz:13 id:'System Fan 3' readin
8358:20130318:111122.172 Added sensor: host:'192.168.1.12:623' id_type:0 id_sz:14 id:'P1 Mem Margin' readi
8358:20130318:111122.172 Added sensor: host:'192.168.1.12:623' id_type:0 id_sz:17 id:'Front Panel Temp' re
8358:20130318:111122.173 Added sensor: host:'192.168.1.12:623' id_type:0 id_sz:15 id:'Baseboard Temp' read
8358:20130318:111122.173 Added sensor: host:'192.168.1.12:623' id_type:0 id_sz:9 id:'BB +5.0V' reading_typ
8358:20130318:111122.173 Added sensor: host:'192.168.1.12:623' id_type:0 id_sz:14 id:'BB +3.3V STBY' readi
8358:20130318:111122.173 Added sensor: host:'192.168.1.12:623' id_type:0 id_sz:9 id:'BB +3.3V' reading_typ
8358:20130318:111122.173 Added sensor: host:'192.168.1.12:623' id_type:0 id_sz:17 id:'BB +1.5V P1 DDR3' re
8358:20130318:111122.173 Added sensor: host:'192.168.1.12:623' id_type:0 id_sz:17 id:'BB +1.1V P1 Vccp' re
8358:20130318:111122.174 Added sensor: host:'192.168.1.12:623' id_type:0 id_sz:14 id:'BB +1.05V PCH' readi
```

To decode IPMI sensor types and states, a copy of [IPMI 2.0 specifications](#) is available (please note that [no further updates](#) to the IPMI specification are planned).

The first parameter to start with is "reading_type". Use "Table 42-1, Event/Reading Type Code Ranges" from the specifications to decode "reading_type" code. Most of the sensors in our example have "reading_type:0x1" which means "threshold" sensor. "Table 42-3, Sensor Type Codes" shows that "type:0x1" means temperature sensor, "type:0x2" - voltage sensor, "type:0x4" - Fan etc. Threshold sensors sometimes are called "analog" sensors as they measure continuous parameters like temperature, voltage, revolutions per minute.

Another example - a sensor with "reading_type:0x3". "Table 42-1, Event/Reading Type Code Ranges" says that reading type codes 02h-0Ch mean "Generic Discrete" sensor. Discrete sensors have up to 15 possible states (in other words - up to 15 meaningful bits). For example, for sensor 'CATERR' with "type:0x7" the "Table 42-3, Sensor Type Codes" shows that this type means "Processor" and the meaning of individual bits is: 00h (the least significant bit) - IERR, 01h - Thermal Trip etc.

There are few sensors with "reading_type:0x6f" in our example. For these sensors the "Table 42-1, Event/Reading Type Code Ranges" advises to use "Table 42-3, Sensor Type Codes" for decoding meanings of bits. For example, sensor 'Power Unit Stat' has type "type:0x9" which means "Power Unit". Offset 00h means "PowerOff/Power Down". In other words if the least significant bit is 1, then server is powered off. To test this bit, the **bitand** function with mask '1' can be used. The trigger expression could be like `bitand(last(/www.example.com/Power Unit Stat,#1),1)=1`

to warn about a server power off.

Notes on discrete sensor names in OpenIPMI-2.0.16, 2.0.17, 2.0.18 and 2.0.19

Names of discrete sensors in OpenIPMI-2.0.16, 2.0.17 and 2.0.18 often have an additional "0" (or some other digit or letter) appended at the end. For example, while `ipmitool` and OpenIPMI-2.0.19 display sensor names as "PhysicalSecurity" or "CATERR", in OpenIPMI-2.0.16, 2.0.17 and 2.0.18 the names are "PhysicalSecurity0" or "CATERR0", respectively.

When configuring an IPMI item with Zabbix server using OpenIPMI-2.0.16, 2.0.17 and 2.0.18, use these names ending with "0" in the *IPMI sensor* field of IPMI agent items. When your Zabbix server is upgraded to a new Linux distribution, which uses OpenIPMI-2.0.19 (or later), items with these IPMI discrete sensors will become "NOT SUPPORTED". You have to change their *IPMI sensor* names (remove the '0' in the end) and wait for some time before they turn "Enabled" again.

Notes on threshold and discrete sensor simultaneous availability

Some IPMI agents provide both a threshold sensor and a discrete sensor under the same name. The preference is always given to the threshold sensor.

Notes on connection termination

If IPMI checks are not performed (by any reason: all host IPMI items disabled/notsupported, host disabled/deleted, host in maintenance etc.) the IPMI connection will be terminated from Zabbix server or proxy in 3 to 4 hours depending on the time when Zabbix server/proxy was started.

5 Simple checks

Overview

Simple checks are normally used for remote agent-less checks of services.

Note that Zabbix agent is not needed for simple checks. Zabbix server/proxy is responsible for the processing of simple checks (making external connections, etc).

Examples of using simple checks:

```
net.tcp.service[ftp,,155]
net.tcp.service[http]
net.tcp.service.perf[http,,8080]
net.udp.service.perf[ntp]
```

Note:

User name and *Password* fields (limited to 255 characters) in simple check item configuration are used for VMware monitoring items; ignored otherwise.

Supported checks

The item keys are listed without optional parameters and additional information. Click on the item key to see the full details.

See also [VMware monitoring item keys](#).

Item key	Description
icmping	The host accessibility by ICMP ping.
icmpingloss	The percentage of lost packets.
icmpingsec	The ICMP ping response time.
net.tcp.service	Checks if a service is running and accepting TCP connections.
net.tcp.service.perf	Checks the performance of a TCP service.
net.udp.service	Checks if a service is running and responding to UDP requests.
net.udp.service.perf	Checks the performance of a UDP service.

Item key details

Parameters without angle brackets are mandatory. Parameters marked with angle brackets < > are optional.

`icmping[<target>,<packets>,<interval>,<size>,<timeout>,<options>]`

 The host accessibility by ICMP ping.
 Return value: *0* - ICMP ping fails; *1* - ICMP ping successful.

Parameters:

- **target** - the host IP or DNS name;
- **packets** - the number of packets;
- **interval** - the time between successive packets in milliseconds;
- **size** - the packet size in bytes;
- **timeout** - the timeout in milliseconds;
- **options** - used for allowing redirect: if empty (default value), redirected responses are treated as target host down; if set to *allow_redirect*, redirected responses are treated as target host up.

See also the table of [default values](#).

Example:

```
icmping[,4] #If at least one packet of the four is returned, the item will return 1.
```

```
icmpingloss[<target>,<packets>,<interval>,<size>,<timeout>,<options>]
```

 The percentage of lost packets.
 Return value: *Float*.

Parameters:

- **target** - the host IP or DNS name;
- **packets** - the number of packets;
- **interval** - the time between successive packets in milliseconds;
- **size** - the packet size in bytes;
- **timeout** - the timeout in milliseconds;

- **options** - used for allowing redirect: if empty (default value), redirected responses are treated as target host down; if set to *allow_redirect*, redirected responses are treated as target host up.

See also the table of [default values](#).

icmppingsec[<target>,<packets>,<interval>,<size>,<timeout>,<mode>,<options>]

 The ICMP ping response time (in seconds).
 Return value: *Float*.

Parameters:

- **target** - the host IP or DNS name;
- **packets** - the number of packets;
- **interval** - the time between successive packets in milliseconds;
- **size** - the packet size in bytes;
- **timeout** - the timeout in milliseconds;
- **mode** - possible values: *min*, *max*, or *avg* (default);
- **options** - used for allowing redirect: if empty (default value), redirected responses are treated as target host down; if set to *allow_redirect*, redirected responses are treated as target host up.

Comments:

- Packets which are lost or timed out are not used in the calculation;
- If the host is not available (timeout reached), the item will return 0;
- If the return value is less than 0.0001 seconds, the value will be set to 0.0001 seconds;
- See also the table of [default values](#).

net.tcp.service[service,<ip>,<port>]

 Checks if a service is running and accepting TCP connections.
 Return value: *0* - the service is down; *1* - the service is running.

Parameters:

- **service** - possible values: *ssh*, *ldap*, *smtp*, *ftp*, *http*, *pop*, *nntp*, *imap*, *tcp*, *https*, *telnet* (see [details](#));
- **ip** - the IP address or DNS name (by default the host IP/DNS is used);
- **port** - the port number (by default the standard service port number is used).

Comments:

- Note that with *tcp* service indicating the port is mandatory;
- These checks may result in additional messages in system daemon logfiles (SMTP and SSH sessions being logged usually);
- Checking of encrypted protocols (like IMAP on port 993 or POP on port 995) is currently not supported. As a workaround, please use `net.tcp.service[tcp,<ip>,<port>]` for checks like these.

Example:

net.tcp.service[ftp,,45] #This item can be used to test the availability of FTP server on TCP port 45.

net.tcp.service.perf[service,<ip>,<port>]

 Checks the performance of a TCP service.
 Return value: *Float: 0.000000* - the service is down; *seconds* - the number of seconds spent while connecting to the service.

Parameters:

- **service** - possible values: *ssh*, *ldap*, *smtp*, *ftp*, *http*, *pop*, *nntp*, *imap*, *tcp*, *https*, *telnet* (see [details](#));
- **ip** - the IP address or DNS name (by default the host IP/DNS is used);
- **port** - the port number (by default the standard service port number is used).

Comments:

- Note that with *tcp* service indicating the port is mandatory;
- Checking of encrypted protocols (like IMAP on port 993 or POP on port 995) is currently not supported. As a workaround, please use `net.tcp.service[tcp,<ip>,<port>]` for checks like these.

Example:

net.tcp.service.perf[ssh] #This item can be used to test the speed of initial response from SSH server.

net.udp.service[service,<ip>,<port>]

 Checks if a service is running and responding to UDP requests.
 Return value: *0* - the service is down; *1* - the service is running.

Parameters:

- **service** - possible values: *ntp* (see [details](#));
- **ip** - the IP address or DNS name (by default the host IP/DNS is used);
- **port** - the port number (by default the standard service port number is used).

Example:

```
net.udp.service[ntp,,45] #This item can be used to test the availability of NTP service on UDP port 45.
net.udp.service.perf[service,<ip>,<port>]
```

 Checks the performance of a UDP service.
 Return value: *Float: 0.000000* - the service is down; *seconds* - the number of seconds spent waiting for response from the service.

Parameters:

- **service** - possible values: *ntp* (see [details](#));
- **ip** - the IP address or DNS name (by default the host IP/DNS is used);
- **port** - the port number (by default the standard service port number is used).

Example:

```
net.udp.service.perf[ntp] #This item can be used to test the response time from NTP service.
```

Attention:

For SourceIP support in LDAP simple checks (e.g. `net.tcp.service[ldap]`), OpenLDAP version 2.6.1 or above is required.

Timeout processing

Zabbix will not process a simple check longer than the *Timeout* seconds defined in the [item configuration](#) form. For [VMware items](#) and [icmping*](#) items, Zabbix will not process a simple check longer than the *Timeout* seconds defined in the Zabbix [server](#) or [proxy](#) configuration file.

ICMP pings

Zabbix uses an external utility [fping](#) to process ICMP pings ([icmping](#), [icmpingloss](#), [icmpingsec](#)).

Installation

fping is not included with Zabbix and needs to be installed separately:

- Various Unix-based platforms have the fping package in their default repositories, but it is not pre-installed. In this case you can use the package manager to install fping.
- Zabbix provides [fping packages](#) for RHEL and its derivatives. Please note that these packages are provided without official support.
- fping can also be compiled [from source](#).

Configuration

Specify fping location in the [FpingLocation](#) parameter of Zabbix server/proxy configuration file (or [Fping6Location](#) parameter for using IPv6 addresses).

fping should be executable by the user Zabbix server/proxy run as and this user should have sufficient rights.

See also: [Known issues](#) for processing simple checks with fping versions below 3.10.

Default values

Defaults, limits and description of values for ICMP check parameters:

Parameter	Unit	Description	Fping's flag	Defaults set by		Allowed limits by Zabbix	
				fping	Zabbix	min	max
packets	number	number of request packets sent to a target	-C		3	1	10000
interval	millisecond	time to wait between successive packets to an individual target	-p	1000		20	unlimited
size	bytes	packet size in bytes 56 bytes on x86, 68 bytes on x86_64	-b	56 or 68		24	65507

Parameter	Unit	Description	Fping's flag	Defaults set by	Allowed limits by Zabbix
timeout	milliseconds	fping v3.x - timeout to wait after last packet sent, affected by -C flag fping v4.x - individual timeout for each packet	-t	fping v3.x - 500 fping v4.x and newer - inherited from -p flag, but not more than 2000	50 unlimited

The defaults may differ slightly depending on the platform and version.

In addition, Zabbix uses fping options **-i interval ms** (do not mix up with the item parameter *interval* mentioned in the table above, which corresponds to fping option **-p**) and **-S source IP address** (or **-l** in older fping versions). These options are auto-detected by running checks with different option combinations. Zabbix tries to detect the minimal value in milliseconds that fping allows to use with **-i** by trying 3 values: 0, 1 and 10. The value that first succeeds is then used for subsequent ICMP checks. This process is done by each **ICMP pinger** process individually.

Auto-detected fping options are invalidated every hour and detected again on the next attempt to perform ICMP check. Set **DebugLevel**>=4 in order to view details of this process in the server or proxy log file.

Zabbix writes IP addresses to be checked by any of the three *icmpping** keys to a temporary file, which is then passed to fping. If items have different key parameters, only the ones with identical key parameters are written to a single file. All IP addresses written to the single file will be checked by fping in parallel, so Zabbix ICMP pinger process will spend fixed amount of time disregarding the number of IP addresses in the file.

1 VMware monitoring item keys

List of VMware monitoring **item keys** has been moved to **VMware monitoring** section.

6 Log file monitoring

Overview

Zabbix can be used for centralized monitoring and analysis of log files with/without log rotation support.

Notifications can be used to warn users when a log file contains certain strings or string patterns.

To monitor a log file you must have:

- Zabbix agent running on the host
- log monitoring item set up

Attention:

The size limit of a monitored log file depends on **large file support**.

Configuration

Verify agent parameters

Make sure that in the **agent configuration file**:

- 'Hostname' parameter matches the host name in the frontend
- Servers in the 'ServerActive' parameter are specified for the processing of active checks

Item configuration

Configure a log monitoring **item**.

Item Tags Preprocessing

* Name

Type

* Key

Type of information

* Update interval

Custom intervals

Type	Interval	Period	Action
<input type="button" value="Flexible"/> <input checked="" type="button" value="Scheduling"/>	<input type="text" value="50s"/>	<input type="text" value="1-7,00:00-24:00"/>	<input type="button" value="Remove"/>

[Add](#)

* Timeout [Timeouts](#)

* History

Log time format

Description

Enabled

All mandatory input fields are marked with a red asterisk.

Specifically for log monitoring items you enter:

<i>Type</i>	Select Zabbix agent (active) here.
<i>Key</i>	Use one of the following item keys: log[] or logrt[] : These two item keys allow to monitor logs and filter log entries by the content regexp, if present. For example: <code>log[/var/log/syslog,error]</code> . Make sure that the file has read permissions for the 'zabbix' user otherwise the item status will be set to 'unsupported'. log.count[] or logrt.count[] : These two item keys allow to return the number of matching lines only. See supported Zabbix agent item key section for details on using these item keys and their parameters.
<i>Type of information</i>	Prefilled automatically: For log[] or logrt[] items - Log; For log.count[] or logrt.count[] items - Numeric (unsigned). If optionally using the output parameter, you may manually select the appropriate type of information other than Log. Note that choosing a non-Log type of information will lead to the loss of local timestamp.
<i>Update interval (in sec)</i>	The parameter defines how often Zabbix agent will check for any changes in the log file. Setting it to 1 second will make sure that you get new records as soon as possible.

<i>Log time format</i>	<p>In this field you may optionally specify the pattern for parsing the log line timestamp. Supported placeholders:</p> <ul style="list-style-type: none"> * y: Year (1970-2038) * M: Month (01-12) * d: Day (01-31) * h: Hour (00-23) * m: Minute (00-59) * s: Second (00-59) <p>If left blank, the timestamp will be set to 0 in Unix time, representing January 1, 1970.</p> <p>For example, consider the following line from the Zabbix agent log file: " 23480:20100328:154718.045 Zabbix agent started. Zabbix 1.8.2 (revision 11211)."</p> <p>It begins with six character positions for PID, followed by date, time, and the rest of the message. The log time format for this line would be "pppppp:yyyyMMdd:hhmmss".</p> <p>Note that "p" and ":" characters are placeholders and can be any character except "yMdhms".</p>
------------------------	--

Important notes

- The server and agent keep the trace of a monitored log's size and last modification time (for logrt) in two counters. Additionally:
 - The agent also internally uses inode numbers (on UNIX/GNU/Linux), file indexes (on Microsoft Windows) and MD5 sums of the first 512 log file bytes for improving decisions when logfiles get truncated and rotated.
 - On UNIX/GNU/Linux systems it is assumed that the file systems where log files are stored report inode numbers, which can be used to track files.
 - On Microsoft Windows Zabbix agent determines the file system type the log files reside on and uses:
 - * On NTFS file systems 64-bit file indexes.
 - * On ReFS file systems (only from Microsoft Windows Server 2012) 128-bit file IDs.
 - * On file systems where file indexes change (e.g. FAT32, exFAT) a fall-back algorithm is used to take a sensible approach in uncertain conditions when log file rotation results in multiple log files with the same last modification time.
 - The inode numbers, file indexes and MD5 sums are internally collected by Zabbix agent. They are not transmitted to Zabbix server and are lost when Zabbix agent is stopped.
 - Do not modify the last modification time of log files with 'touch' utility, do not copy a log file with later restoration of the original name (this will change the file inode number). In both cases the file will be counted as different and will be analyzed from the start, which may result in duplicated alerts.
 - If there are several matching log files for logrt [] item and Zabbix agent is following the most recent of them and this most recent log file is deleted, a warning message "there are no files matching "<regex mask>" in "<directory>" is logged. Zabbix agent ignores log files with modification time less than the most recent modification time seen by the agent for the logrt [] item being checked.
- The agent starts reading the log file from the point it stopped the previous time.
- The number of bytes already analyzed (the size counter) and last modification time (the time counter) are stored in the Zabbix database and are sent to the agent to make sure the agent starts reading the log file from this point in cases when the agent is just started or has received items which were previously disabled or not supported. However, if the agent has received a non-zero size counter from server, but the logrt[] or logrt.count[] item is unable to find matching files, the size counter is reset to 0 to analyze from the start if the files appear later.
- Whenever the log file becomes smaller than the log size counter known by the agent, the counter is reset to zero and the agent starts reading the log file from the beginning taking the time counter into account.
- If there are several matching files with the same last modification time in the directory, then the agent tries to correctly analyze all log files with the same modification time and avoid skipping data or analyzing the same data twice, although it cannot be guaranteed in all situations. The agent does not assume any particular log file rotation scheme nor determines one. When presented multiple log files with the same last modification time, the agent will process them in a lexicographically descending order. Thus, for some rotation schemes the log files will be analyzed and reported in their original order. For other rotation schemes the original log file order will not be honored, which can lead to reporting matched log file records in altered order (the problem does not happen if log files have different last modification times).
- Zabbix agent processes new records of a log file once per *Update interval* seconds.
- Zabbix agent does not send more than **maxlines** of a log file per second. The limit prevents overloading of network and CPU resources and overrides the default value provided by **MaxLinesPerSecond** parameter in the [agent configuration file](#).
- To find the required string Zabbix will process 10 times more new lines than set in MaxLinesPerSecond. Thus, for example, if a log [] or logrt [] item has *Update interval* of 1 second, by default the agent will analyze no more than 200 log file records and will send no more than 20 matching records to Zabbix server in one check. By increasing **MaxLinesPerSecond** in the agent configuration file or setting **maxlines** parameter in the item key, the limit can be increased up to 10000 analyzed log file records and 1000 matching records sent to Zabbix server in one check. If the *Update interval* is set to 2 seconds the limits for one check would be set 2 times higher than with *Update interval* of 1 second.

- Additionally, log and log.count values are always limited to 50% of the agent send buffer size, even if there are no non-log values in it. So for the **maxlines** values to be sent in one connection (and not in several connections), the agent **BufferSize** parameter must be at least maxlines x 2. Zabbix agent can upload data during log gathering and thus free the buffer, whereas Zabbix agent 2 will stop log gathering until the data is uploaded and the buffer is freed, which is performed asynchronously.
- In the absence of log items all agent buffer size is used for non-log values. When log values come in they replace the older non-log values as needed, up to the designated 50%.
- For log file records longer than 256kB, only the first 256kB are matched against the regular expression and the rest of the record is ignored. However, if Zabbix agent is stopped while it is dealing with a long record the agent internal state is lost and the long record may be analyzed again and differently after the agent is started again.
- Special note for “\” path separators: if file_format is “file.log”, then there should not be a “file” directory, since it is not possible to unambiguously define whether “.” is escaped or is the first symbol of the file name.
- Regular expressions for logrt are supported in filename only, directory regular expression matching is not supported.
- On UNIX platforms a logrt [] item becomes NOTSUPPORTED if a directory where the log files are expected to be found does not exist.
- On Microsoft Windows, if a directory does not exist the item will not become NOTSUPPORTED (for example, if directory is misspelled in item key).
- An absence of log files for logrt [] item does not make it NOTSUPPORTED. Errors of reading log files for logrt [] item are logged as warnings into Zabbix agent log file but do not make the item NOTSUPPORTED.
- Zabbix agent log file can be helpful to find out why a log [] or logrt [] item became NOTSUPPORTED. Zabbix can monitor its agent log file, except when at DebugLevel=4 or DebugLevel=5.
- Searching for a question mark using a regular expression, e.g. \? may result in false positives if the text file contains NUL symbols, as those are replaced with “?” by Zabbix to continue processing the line until the newline character.

Extracting matching part of regular expression

Sometimes we may want to extract only the interesting value from a target file instead of returning the whole line when a regular expression match is found.

Log items have the ability to extract desired values from matched lines. This is accomplished by the additional **output** parameter in log and logrt items.

Using the ‘output’ parameter allows to indicate the “capturing group” of the match that we may be interested in.

So, for example

```
log[/path/to/the/file,"large result buffer allocation.*Entries: ([0-9]+)",,,\1]
```

should allow returning the entry count as found in the content of:

```
Fr Feb 07 2014 11:07:36.6690 */ Thread Id 1400 (GLEWF) large result
buffer allocation - /Length: 437136/Entries: 5948/Client Ver: >=10/RPC
ID: 41726453/User: AUser/Form: CFG:ServiceLevelAgreement
```

Only the number will be returned because \1 refers to the first and only capturing group: **([0-9]+)**.

And, with the ability to extract and return a number, the value can be used to define triggers.

Using maxdelay parameter

The ‘maxdelay’ parameter in log items allows ignoring some older lines from log files in order to get the most recent lines analyzed within the ‘maxdelay’ seconds.

Warning:

Specifying ‘maxdelay’ > 0 may lead to **ignoring important log file records and missed alerts**. Use it carefully at your own risk only when necessary.

By default items for log monitoring follow all new lines appearing in the log files. However, there are applications which in some situations start writing an enormous number of messages in their log files. For example, if a database or a DNS server is unavailable, such applications flood log files with thousands of nearly identical error messages until normal operation is restored. By default, all those messages will be dutifully analyzed and matching lines sent to server as configured in log and logrt items.

Built-in protection against overload consists of a configurable ‘maxlines’ parameter (protects server from too many incoming matching log lines) and a 10*‘maxlines’ limit (protects host CPU and I/O from overloading by agent in one check). Still, there are 2 problems with the built-in protection. First, a large number of potentially not-so-informative messages are reported to server and consume space in the database. Second, due to the limited number of lines analyzed per second the agent may lag behind the newest log records for hours. Quite likely, you might prefer to be sooner informed about the current situation in the log files instead of crawling through old records for hours.

The solution to both problems is using the 'maxdelay' parameter. If 'maxdelay' > 0 is specified, during each check the number of processed bytes, the number of remaining bytes and processing time is measured. From these numbers the agent calculates an estimated delay - how many seconds it would take to analyze all remaining records in a log file.

If the delay does not exceed 'maxdelay' then the agent proceeds with analyzing the log file as usual.

If the delay is greater than 'maxdelay' then the agent **ignores a chunk of a log file by "jumping" over it** to a new estimated position so that the remaining lines could be analyzed within 'maxdelay' seconds.

Note that agent does not even read ignored lines into buffer, but calculates an approximate position to jump to in a file.

The fact of skipping log file lines is logged in the agent log file like this:

```
14287:20160602:174344.206 item:"logrt["/home/zabbix32/test[0-9].log",ERROR,,1000,,120.0]"
logfile:"/home/zabbix32/test1.log" skipping 679858 bytes
(from byte 75653115 to byte 76332973) to meet maxdelay
```

The "to byte" number is approximate because after the "jump" the agent adjusts the position in the file to the beginning of a log line which may be further in the file or earlier.

Depending on how the speed of growing compares with the speed of analyzing the log file you may see no "jumps", rare or often "jumps", large or small "jumps", or even a small "jump" in every check. Fluctuations in the system load and network latency also affect the calculation of delay and hence, "jumping" ahead to keep up with the "maxdelay" parameter.

Setting 'maxdelay' < 'update interval' is not recommended (it may result in frequent small "jumps").

Notes on handling 'copytruncate' log file rotation

logrt with the copytruncate option assumes that different log files have different records (at least their timestamps are different), therefore MD5 sums of initial blocks (up to the first 512 bytes) will be different. Two files with the same MD5 sums of initial blocks means that one of them is the original, another - a copy.

logrt with the copytruncate option makes effort to correctly process log file copies without reporting duplicates. However, things like producing multiple log file copies with the same timestamp, log file rotation more often than logrt[] item update interval, frequent restarting of agent are not recommended. The agent tries to handle all these situations reasonably well, but good results cannot be guaranteed in all circumstances.

Notes on persistent files for log*[] items

Purpose of persistent files

When Zabbix agent is started it receives a list of active checks from Zabbix server or proxy. For log*[] metrics it receives the processed log size and the modification time for finding where to start log file monitoring from. Depending on the actual log file size and modification time reported by file system the agent decides either to continue log file monitoring from the processed log size or re-analyze the log file from the beginning.

A running agent maintains a larger set of attributes for tracking all monitored log files between checks. This in-memory state is lost when the agent is stopped.

The new optional parameter **persistent_dir** specifies a directory for storing this state of log[], log.count[], logrt[] or logrt.count[] item in a file. The state of log item is restored from the persistent file after the Zabbix agent is restarted.

The primary use-case is monitoring of log file located on a mirrored file system. Until some moment in time the log file is written to both mirrors. Then mirrors are split. On the active copy the log file is still growing, getting new records. Zabbix agent analyzes it and sends processed logs size and modification time to server. On the passive copy the log file stays the same, well behind the active copy. Later the operating system and Zabbix agent are rebooted from the passive copy. The processed log size and modification time the Zabbix agent receives from server may not be valid for situation on the passive copy. To continue log file monitoring from the place the agent left off at the moment of file system mirror split the agent restores its state from the persistent file.

Agent operation with persistent file

On startup Zabbix agent knows nothing about persistent files. Only after receiving a list of active checks from Zabbix server (proxy) the agent sees that some log items should be backed by persistent files under specified directories.

During agent operation the persistent files are opened for writing (with fopen(filename, "w")) and overwritten with the latest data. The chance of losing persistent file data if the overwriting and file system mirror split happen at the same time is very small, no special handling for it. Writing into persistent file is NOT followed by enforced synchronization to storage media (fsync() is not called).

Overwriting with the latest data is done after successful reporting of matching log file record or metadata (processed log size and modification time) to Zabbix server. That may happen as often as every item check if log file keeps changing.

No special actions during agent shutdown.

After receiving a list of active checks the agent marks obsolete persistent files for removal. A persistent file becomes obsolete if: 1) the corresponding log item is no longer monitored, 2) a log item is reconfigured with a different **persistent_dir** location than before.

Removing is done with delay 24 hours because log files in NOTSUPPORTED state are not included in the list of active checks but they may become SUPPORTED later and their persistent files will be useful.

If the agent is stopped before 24 hours expire, then the obsolete files will not be deleted as Zabbix agent is not getting info about their location from Zabbix server anymore.

Warning:

Reconfiguring a log item's **persistent_dir** back to the old **persistent_dir** location while the agent is stopped, without deleting the old persistent file by user - will cause restoring the agent state from the old persistent file resulting in missed messages or false alerts.

Naming and location of persistent files

Zabbix agent distinguishes active checks by their keys. For example, `logrt[/home/zabbix/test.log]` and `logrt[/home/zabbix/test.log,]` are different items. Modifying the item `logrt[/home/zabbix/test.log,,10]` in frontend to `logrt[/home/zabbix/test.log,,20]` will result in deleting the item `logrt[/home/zabbix/test.log,,10]` from the agent's list of active checks and creating `logrt[/home/zabbix/test.log,,20]` item (some attributes are carried across modification in frontend/server, not in agent).

The file name is composed of MD5 sum of item key with item key length appended to reduce possibility of collisions. For example, the state of `logrt[/home/zabbix50/test.log,,,,,]/home/zabbix50/agent_private]` item will be kept in persistent file `c963ade4008054813bbc0a650bb8e09266`.

Multiple log items can use the same value of **persistent_dir**.

persistent_dir is specified by taking into account specific file system layouts, mount points and mount options and storage mirroring configuration - the persistent file should be on the same mirrored filesystem as the monitored log file.

If **persistent_dir** directory cannot be created or does not exist, or access rights for Zabbix agent does not allow to create/write/read/delete files the log item becomes NOTSUPPORTED.

If access rights to persistent storage files are removed during agent operation or other errors occur (e.g. disk full) then errors are logged into the agent log file but the log item does not become NOTSUPPORTED.

Load on I/O

Item's persistent file is updated after successful sending of every batch of data (containing item's data) to server. For example, default 'BufferSize' is 100. If a log item has found 70 matching records then the first 50 records will be sent in one batch, persistent file will be updated, then remaining 20 records will be sent (maybe with some delay when more data is accumulated) in the 2nd batch, and the persistent file will be updated again.

Actions if communication fails between agent and server

Each matching line from `log []` and `logrt []` item and a result of each `log.count []` and `logrt.count []` item check requires a free slot in the designated 50% area in the agent send buffer. The buffer elements are regularly sent to server (or proxy) and the buffer slots are free again.

While there are free slots in the designated log area in the agent send buffer and communication fails between agent and server (or proxy) the log monitoring results are accumulated in the send buffer. This helps to mitigate short communication failures.

During longer communication failures all log slots get occupied and the following actions are taken:

- `log []` and `logrt []` item checks are stopped. When communication is restored and free slots in the buffer are available the checks are resumed from the previous position. No matching lines are lost, they are just reported later.
- `log.count []` and `logrt.count []` checks are stopped if `maxdelay = 0` (default). Behavior is similar to `log []` and `logrt []` items as described above. Note that this can affect `log.count []` and `logrt.count []` results: for example, one check counts 100 matching lines in a log file, but as there are no free slots in the buffer the check is stopped. When communication is restored the agent counts the same 100 matching lines and also 70 new matching lines. The agent now sends `count = 170` as if they were found in one check.
- `log.count []` and `logrt.count []` checks with `maxdelay > 0`: if there was no "jump" during the check, then behavior is similar to described above. If a "jump" over log file lines took place then the position after "jump" is kept and the counted result is discarded. So, the agent tries to keep up with a growing log file even in case of communication failure.

Handling of regular expression compilation and runtime errors

If a regular expression used in `log []`, `logrt []`, `log.count []` or `logrt.count []` item cannot be compiled by PCRE or PCRE2 library then the item goes into NOTSUPPORTED state with an error message. To continue monitoring the log item, the regular expression should be fixed.

If the regular expression compiles successfully, but fails at runtime (on some or on all log records), then the log item remains supported and monitoring continues. The runtime error is logged in the Zabbix agent log file (without the log file record).

The logging rate is limited to one runtime error per check to allow Zabbix agent to monitor its own log file. For example, if 10 records are analyzed and 3 records fail with a regexp runtime error, one record is produced in the agent log.

Exception: if `MaxLinesPerSecond=1` and `update interval=1` (only 1 record is allowed to analyze per check) then regexp runtime errors are not logged.

`zabbix_agentd` logs the item key in case of a runtime error, `zabbix_agent2` logs the item ID to help identify which log item has runtime errors. It is recommended to redesign the regular expression in case of runtime errors.

7 Calculated items

Overview

A calculated item allows to create a calculation based on the values of some existing items. For example, you may want to calculate the hourly average of some item value or to calculate the total value for a group of items. That is what a calculated item is for.

Calculations may use both:

- single values of individual items
- a complex filter to select multiple items for aggregation (see [aggregate calculations](#) for details)

Calculated items are a way of creating virtual data sources. All calculations are done by Zabbix server only. The values are periodically calculated based on the arithmetical expression used.

The resulting data is stored in the Zabbix database as for any other item; both history and trend values are stored and graphs can be generated.

Note:

If the calculation result is a float value it will be trimmed to an integer if the calculated item type of information is *Numeric (unsigned)*.

Also, if there is no recent data in the cache and there is no defined querying period in the function, Zabbix will by default go as far back in the past as one week to query the database for historical values.

Calculated items share their syntax with trigger [expressions](#). Comparison to strings is allowed in calculated items. Calculated items may be referenced by macros or other entities same as any other item type.

To use calculated items, choose the item type **Calculated**.

Configurable fields

The **key** is a unique item identifier (per host). You can create any key name using supported symbols.

The calculation definition should be entered in the **Formula** field. There is no connection between the formula and the key. The key parameters are not used in the formula in any way.

The syntax of a simple formula is:

```
function(/host/key,<parameter1>,<parameter2>,...)
```

where:

<i>function</i>	One of the supported functions : last, min, max, avg, count, etc
<i>host</i>	Host of the item that is used for calculation. The current host can be omitted (i.e. as in <code>function(/key,parameter,...)</code>).
<i>key</i>	Key of the item that is used for calculation.
<i>parameter(s)</i>	Parameters of the function, if required.

Attention:

User macros in the formula will be expanded if used to reference a function parameter, item filter parameter, or a constant. User macros will NOT be expanded if referencing a function, host name, item key, item key parameter or operator.

A more complex formula may use a combination of functions, operators and brackets. You can use all functions and [operators](#) supported in trigger expressions. The logic and operator precedence are exactly the same.

Unlike trigger expressions, Zabbix processes calculated items according to the item update interval, not upon receiving a new value.

All items that are referenced by history functions in the calculated item formula must exist and be collecting data. Also, if you change the item key of a referenced item, you have to manually update any formulas using that key.

A calculated item may become unsupported in several cases:

- referenced item(s)
 - is not found
 - is disabled
 - belongs to a disabled host
 - is not supported (except with `nodata()` function and **operators** with unknown values)
- no data to calculate a function
- division by zero
- incorrect syntax used

Usage examples

Example 1

Calculating percentage of free disk space on '/'.

Use of function **last**:

```
100*last(/vfs.fs.size[/,free])/last(/vfs.fs.size[/,total])
```

Zabbix will take the latest values for free and total disk spaces and calculate percentage according to the given formula.

Example 2

Calculating a 10-minute average of the number of values processed by Zabbix.

Use of function **avg**:

```
avg(/Zabbix Server/zabbix[wcache,values],10m)
```

Note that extensive use of calculated items with long time periods may affect performance of Zabbix server.

Example 3

Calculating total bandwidth on eth0.

Sum of two functions:

```
last(/net.if.in[eth0,bytes])+last(/net.if.out[eth0,bytes])
```

Example 4

Calculating percentage of incoming traffic.

More complex expression:

```
100*last(/net.if.in[eth0,bytes])/(last(/net.if.in[eth0,bytes])+last(/net.if.out[eth0,bytes]))
```

See also: [Examples of aggregate calculations](#)

1 Aggregate calculations

Overview

Aggregate calculations are a **calculated item** type allowing to collect information from several items by Zabbix server and then calculate an aggregate, depending on the aggregate function used.

Aggregate calculations do not require any agent running on the host being monitored.

Syntax

To retrieve aggregates use one of the supported **aggregate functions**: `avg`, `max`, `min`, `sum`, etc. Then add the **foreach** function as the only parameter and its item filter to select the required items:

```
aggregate_function(function_foreach(/host/key?[group="host group"],timeperiod))
```

A **foreach** function (e.g. `avg_foreach`, `count_foreach`, etc.) returns one aggregate value for each selected item. Items are selected by using the item filter (`/host/key?[group="host group"]`), from item history. For more details, see [foreach functions](#).

If some of the items have no data for the requested period, they are ignored in the calculation. If no items have data, the function will return an error.

Alternatively you may list several items as parameters for aggregation:

```
aggregate_function(function(/host/key,parameter),function(/host2/key2,parameter),...)
```

Note that function here must be a history/trend function.

Note:

If the aggregate results in a float value it will be trimmed to an integer if the aggregated item type of information is *Numeric (unsigned)*.

User macros and low-level discovery macros are supported in:

- item key parameters
- function parameters
- filter conditions (host group name and tag name)
- expression constants

An aggregate calculation may become unsupported if:

- none of the referenced items is found (which may happen if the item key is incorrect, none of the items exists or all included groups are incorrect)
- no data to calculate a function

Usage examples

Examples of keys for aggregate calculations.

Example 1

Total disk space of host group 'MySQL Servers'.

```
sum(last_foreach(/*/vfs.fs.size[/,total]?[group="MySQL Servers"]))
```

Example 2

Sum of latest values of all items matching net.if.in[*] on the host.

```
sum(last_foreach(/host/net.if.in[*]))
```

Example 3

Average processor load of host group 'MySQL Servers'.

```
avg(last_foreach(/*/system.cpu.load[,avg1]?[group="MySQL Servers"]))
```

Example 4

5-minute average of the number of queries per second for host group 'MySQL Servers'.

```
avg(avg_foreach(/*/mysql.qps?[group="MySQL Servers"],5m))
```

Example 5

Average CPU load on all hosts in multiple host groups that have the specific tags.

```
avg(last_foreach(/*/system.cpu.load?[(group="Servers A" or group="Servers B" or group="Servers C") and (tag="tag1")]))
```

Example 6

Calculation used on the latest item value sums of a whole host group.

```
sum(last_foreach(/*/net.if.out[eth0,bytes]?[group="video"])) / sum(last_foreach(/*/nginx_stat.sh[active]?[group="video"]))
```

Example 7

The total number of unsupported items in host group 'Zabbix servers'.

```
sum(last_foreach(/*/zabbix[host,,items_unsupported]?[group="Zabbix servers"]))
```

Examples of correct/incorrect syntax

Expressions (including function calls) cannot be used as history, trend, or foreach **function** parameters. However, those functions themselves can be used in other (non-historical) function parameters.

Expression	Example
Valid	<pre>avg(last(/host/key1),last(/host/key2)*10,last(/host/key1)*100) max(avg(avg_foreach(/*/system.cpu.load?[group="Servers A"],5m)),avg(avg_foreach(/*/system.cpu.load?[group="Servers B"],5m)),avg(avg_foreach(/*/system.cpu.load?[group="Servers C"],5m)))</pre>
Invalid	<pre>sum(/host/key,10+2) sum(/host/key, avg(10,2)) sum(/host/key,last(/host/key2))</pre>

Note that in an expression like:

```
sum(sum_foreach(/resptime[*],5m))/sum(count_foreach(/resptime[*],5m))
```

it cannot be guaranteed that both parts of the equation will always have the same set of values. While one part of the expression is evaluated, a new value for the requested period may arrive and then the other part of the expression will have a different set of values.

8 Internal checks

Overview

Internal checks allow to monitor the internal processes of Zabbix. In other words, you can monitor what goes on with Zabbix server or Zabbix proxy.

Internal checks are calculated:

- on Zabbix server - if the host is monitored by server
- on Zabbix proxy - if the host is monitored by proxy

Internal checks are processed by server or proxy regardless of the host maintenance status.

To use this item, choose the **Zabbix internal** item type.

Note:

Internal checks are processed by Zabbix pollers.

Performance

Using some internal items may negatively affect performance. These items are:

- `zabbix[host,,items]`
- `zabbix[host,,items_unsupported]`
- `zabbix[hosts]`
- `zabbix[items]`
- `zabbix[items_unsupported]`
- `zabbix[queue,,]`
- `zabbix[requiredperformance]`
- `zabbix[stats,,queue,,]`
- `zabbix[triggers]`

The **System information** and **Queue** frontend sections are also affected.

Supported checks

The item keys are listed without customizable parameters and additional information. Click on the item key to see the full details.

Item key	Description
zabbix[boottime]	The startup time of Zabbix server or Zabbix proxy process in seconds.
zabbix[cluster_discovery_nodes]	Discovers the high availability cluster nodes.
zabbix[connector_queue]	The count of values enqueued in the connector queue.
zabbix[discovery_queue]	The count of network checks enqueued in the discovery queue.
zabbix[host,items]	The number of enabled items (supported and not supported) on the host.
zabbix[host,items_unsupported]	The number of enabled unsupported items on the host.
zabbix[host,maintenance]	The current maintenance status of the host.
zabbix[host,active_agent_availability]	The availability of active agent checks on the host.
zabbix[host,discovery_interfaces]	The details of all configured interfaces of the host in Zabbix frontend.

Item key	Description
<code>zabbix[host,,available]</code>	The availability of the main interface of a particular type of checks on the host.
<code>zabbix[hosts]</code>	The number of monitored hosts.
<code>zabbix[items]</code>	The number of enabled items (supported and not supported).
<code>zabbix[items_unsupported]</code>	The number of unsupported items.
<code>zabbix[java,,]</code>	The information about Zabbix Java gateway.
<code>zabbix[lld_queue]</code>	The count of values enqueued in the low-level discovery processing queue.
<code>zabbix[preprocessing_queue]</code>	The count of values enqueued in the preprocessing queue.
<code>zabbix[process,,]</code>	The percentage of time a particular Zabbix process or a group of processes (identified by <type> and <mode>) spent in <state>.
<code>zabbix[proxy,,]</code>	The information about Zabbix proxy.
<code>zabbix[proxy,discovery]</code>	The list of Zabbix proxies.
<code>zabbix[proxy group,,available]</code>	The number of online proxies in a proxy group.
<code>zabbix[proxy group,,pavailable]</code>	The percentage of online proxies in a proxy group.
<code>zabbix[proxy group,,proxies]</code>	The list of Zabbix proxies in a proxy group.
<code>zabbix[proxy group,,state]</code>	The state of a proxy group.
<code>zabbix[proxy group,discovery]</code>	Returns a list of proxy groups with configuration data and real-time data.
<code>zabbix[proxy_buffer,buffer,]</code>	Returns the proxy memory buffer usage statistics.
<code>zabbix[proxy_buffer,state,changes]</code>	Returns the number of state changes between disk/memory buffer modes since start.
<code>zabbix[proxy_buffer,state,current]</code>	Returns the current working state where the new data are being stored.
<code>zabbix[proxy_history]</code>	The number of values in the proxy history table waiting to be sent to the server.
<code>zabbix[queue,,]</code>	The number of monitored items in the queue which are delayed at least by <from> seconds, but less than <to> seconds.
<code>zabbix[rcache,,]</code>	The availability statistics of the Zabbix configuration cache.
<code>zabbix[requiredperformance]</code>	The required performance of Zabbix server or Zabbix proxy, in new values per second expected.
<code>zabbix[stats,,]</code>	The internal metrics of a remote Zabbix server or proxy.
<code>zabbix[stats,,queue,,]</code>	The internal queue metrics of a remote Zabbix server or proxy.
<code>zabbix[tcache,,]</code>	The effectiveness statistics of the Zabbix trend function cache.
<code>zabbix[triggers]</code>	The number of enabled triggers in Zabbix database, with all items enabled on enabled hosts.
<code>zabbix[uptime]</code>	The uptime of the Zabbix server or proxy process in seconds.
<code>zabbix[vcache,buffer,]</code>	The availability statistics of the Zabbix value cache.
<code>zabbix[vcache,cache,]</code>	The effectiveness statistics of the Zabbix value cache.
<code>zabbix[version]</code>	The version of Zabbix server or proxy.
<code>zabbix[vmware,buffer,]</code>	The availability statistics of the Zabbix vmware cache.
<code>zabbix[vps,written]</code>	The total number of history values written to database.
<code>zabbix[wcache,,]</code>	The statistics and availability of the Zabbix write cache.

Item key details

- Parameters without angle brackets are mandatory and must be used as *is* (for example, "host" and "available" in `zabbix[host,<type>,available]`).
- Parameters with angle brackets < > must be replaced with a valid value. If a parameter has a default value, it can be omitted.
- Values for items and item parameters labeled "not supported on proxy" can only be retrieved if the host is monitored by server. Conversely, values "not supported on server" can only be retrieved if the host is monitored by proxy.

`zabbix[boottime]`

 The startup time of Zabbix server or Zabbix proxy process in seconds.
 Return value: *Integer*.

`zabbix[cluster,discovery,nodes]`

 Discovers the **high availability cluster** nodes.
 Return value: *JSON object*.

Comments:

- This item can be used in low-level discovery.

`zabbix[connector_queue]`

 The count of values enqueued in the connector queue.
 Return value: *Integer*.

zabbix[discovery_queue]

 The count of network checks enqueued in the discovery queue.
 Return value: *Integer*.

zabbix[host,,items]

 The number of enabled items (supported and not supported) on the host.
 Return value: *Integer*.

zabbix[host,,items_unsupported]

 The number of enabled unsupported items on the host.
 Return value: *Integer*.

zabbix[host,,maintenance]

 The current maintenance status of the host.
 Return values: 0 - normal state; 1 - maintenance with data collection; 2 - maintenance without data collection.

Comments:

- This item is always processed by Zabbix server regardless of the host location (on server or proxy). The proxy will not receive this item with configuration data.
- The second parameter must be empty and is reserved for future use.

zabbix[host,active_agent,available]

 The availability of active agent checks on the host.
 Return values: 0 - unknown; 1 - available; 2 - not available.

zabbix[host,discovery,interfaces]

 The details of all configured interfaces of the host in Zabbix frontend.
 Return value: *JSON object*.

Comments:

- This item can be used in **low-level discovery**.
- This item is not supported on Zabbix proxy.

zabbix[host,<type>,available]

 The availability of the main interface of a particular type of checks on the host.
 Return values: 0 - not available; 1 - available; 2 - unknown.

Parameters:

- **type** - *agent, snmp, ipmi, or jmx*.

Comments:

- The item value is calculated according to the configuration parameters regarding host **unreachability/unavailability**.

zabbixhosts

 The number of monitored hosts.
 Return value: *Integer*.

zabbixitems

 The number of enabled items (supported and not supported).
 Return value: *Integer*.

zabbix[items_unsupported]

 The number of unsupported items.
 Return value: *Integer*.

zabbix[java,,<param>]

 The information about Zabbix Java gateway.
 Return values: 1 - if <param> is *ping*; *Java gateway version* - if <param> is *version* (for example: "7.2.0").

Parameters:

- **param** - *ping or version*.

Comments:

- This item can be used to check Java gateway availability using the `nodata()` trigger function.
- The second parameter must be empty and is reserved for future use.

zabbix[lld_queue]

 The count of values enqueued in the low-level discovery processing queue.
 Return value: *Integer*.

Comments:

- This item can be used to monitor the low-level discovery processing queue length.

`zabbix[preprocessing_queue]`

 The count of values enqueued in the preprocessing queue.
 Return value: *Integer*.

Comments:

- This item can be used to monitor the preprocessing queue length.

`zabbix[process,<type>,<mode>,<state>]`

 The percentage of time a particular Zabbix process or a group of processes (identified by <type> and <mode>) spent in <state>. It is calculated for the last minute only.
 Return value: *Float*.

Parameters:

- **type** - for **server processes**: *agent poller, alert manager, alert syncer, alerter, availability manager, configuration syncer, configuration syncer worker, connector manager, connector worker, discovery manager, discovery worker, escalator, ha manager, history poller, history syncer, housekeeper, http agent poller, http poller, icmp pinger, ipmi manager, ipmi poller, java poller, lld manager, lld worker, odbc poller, poller, preprocessing manager, preprocessing worker, proxy group manager, proxy poller, self-monitoring, service manager, snmp poller, snmp trapper, task manager, timer, trapper, trigger housekeeper, unreachable poller, vmware collector*;
 for **proxy processes**: *agent poller, availability manager, configuration syncer, data sender, discovery manager, discovery worker, history syncer, housekeeper, http agent poller, http poller, icmp pinger, ipmi manager, ipmi poller, java poller, odbc poller, poller, preprocessing manager, preprocessing worker, self-monitoring, snmp poller, snmp trapper, task manager, trapper, unreachable poller, vmware collector*;
- **mode** - *avg* - average value for all processes of a given type (default);
 count - returns number of forks for a given process type, <state> should not be specified;
 max - maximum value;
 min - minimum value;
 <process number> - process number (between 1 and the number of pre-forked instances; for example, if 4 trappers are running, the value is between 1 and 4);
- **state** - *busy* - process is in busy state, for example, the processing request (default);
 idle - process is in idle state doing nothing.

Comments:

- If <mode> is a Zabbix process number that is not running (for example, with 5 pollers running the <mode> is specified to be 6), such an item will turn unsupported.
- Minimum and maximum refers to the usage percentage for a single process. So if in a group of 3 pollers usage percentages per process were 2, 18 and 66, min would return 2 and max would return 66.
- Processes report what they are doing in shared memory and the self-monitoring process summarizes that data each second. State changes (busy/idle) are registered upon change - thus a process that becomes busy registers as such and doesn't change or update the state until it becomes idle. This ensures that even fully hung processes will be correctly registered as 100% busy.
- Currently, "busy" means "not sleeping", but in the future additional states might be introduced - waiting for locks, performing database queries, etc. Note that asynchronous pollers are considered busy if they have reached the limit set by the `MaxConcurrentChecksPerPoller` **server/proxy** configuration parameter.
- On Linux and most other systems, resolution is 1/100 of a second.

Examples:

```
zabbix[process,poller,avg,busy] #the average time of poller processes spent doing something during the last minute
zabbix[process,"icmp pinger",max,busy] #the maximum time spent doing something by any ICMP pinger process
zabbix[process,"history syncer",2,busy] #the time spent doing something by history syncer number 2 during the last minute
zabbix[process,trapper,count] #the amount of currently running trapper processes
```

`zabbix[proxy,<name>,<param>]`

 The information about Zabbix proxy.
 Return value: *Integer*.

Parameters:

- **name** - the proxy name;
- **param** - *lastaccess* - the timestamp of the last heartbeat message received from proxy;
 delay - how long the collected values are unspent; calculated as "proxy delay" + ("current server time" - "proxy lastaccess"), where "proxy delay" is the difference between the current proxy time and the timestamp of the oldest unspent value on proxy.

Comments:

- This item is always processed by Zabbix server regardless of host location (on server or proxy).
- The `fuzzytime()` function can be used to check the availability of proxy.

Example:

zabbix[proxy,"Germany",lastaccess] #the timestamp of the last heartbeat message received from "Germany" pr

zabbix[proxy,discovery]

 The list of Zabbix proxies with name, mode, encryption, compression, version, last seen, host count, item count, required values per second (vps), version status (current/outdated/unsupported), timeouts by item type, proxy group name (if proxy belongs to group), state (unknown/offline/online).
 Return value: *JSON object*.

zabbix[proxy group,<name>,available]

 The number of online proxies in a proxy group.
 Return value: *Integer*.

Parameters:

- **name** - the proxy group name.

zabbix[proxy group,<name>,pavailable]

 The percentage of online proxies in a proxy group.
 Return value: *Float*.

Parameters:

- **name** - the proxy group name.

zabbix[proxy group,<name>,proxies]

 The list of Zabbix proxies in a proxy group with name, mode, encryption, compression, version, last seen, host count, item count, required values per second (vps), version status (current/outdated/unsupported), timeouts, proxy group name, state (unknown/offline/online).
 Return value: *JSON*.

Parameters:

- **name** - the proxy group name.

zabbix[proxy group,<name>,state]

 The state of a proxy group.
 Return value: 0 - unknown; 1 - offline; 2 - recovering; 3 - online; 4 - degrading.

Parameters:

- **name** - the proxy group name.

zabbix[proxy group,discovery]

 Returns a list of proxy groups with configuration data and real-time data. Configuration data include the proxy group name, failover delay, and the minimum number of online proxies required. Real-time data include the proxy group state (see comments for details), the number of online proxies, and the percentage of online proxies.
 Return value: *JSON*.

Comments:

- This item does not return groupless proxies.
- If there is an invalid value for "failover_delay" or "min_online", then a special value -1 is reported to indicate that. Invalid values might occur if macros are used for configuration and the macros cannot be expanded to a valid value.
- The proxy group state is reported as an integer: 0 - unknown; 1 - offline; 2 - recovering; 3 - online; 4 - degrading.

Example of return values:

```
{
  "groups": [
    { "name": "Riga", "failover_delay": 60, "min_online": 1 },
    { "name": "Tokyo", "failover_delay": 60, "min_online": 2 },
    { "name": "Porto Alegre", "failover_delay": 60, "min_online": 3 }
  ],
  "details": {
    "Riga": { "state": 3, "available": 10, "pavailable": 20 },
    "Tokyo": { "state": 3, "available": 10, "pavailable": 20 },
    "Porto Alegre": { "state": 1, "available": 0, "pavailable": 0 }
  }
}
```

zabbix[proxy_buffer,buffer,<mode>]

 The proxy memory buffer usage statistics.
 Return values: *Integer* (for size); *Float* (for percentage).

Parameters:

- **mode:** *total* - the total size of buffer (can be used to check if memory buffer is enabled);
free - the size of free buffer;
pfree - the percentage of free buffer;
used - the size of used buffer;
pused - the percentage of used buffer.

Comments:

- Returns a 'Proxy memory buffer is disabled' error when the memory buffer is disabled;
- This item is not supported on Zabbix server.

zabbix[proxy_buffer,state,changes]

Returns the number of state changes between disk/memory buffer modes since start. Return values: *Integer*; 0 - the memory buffer is disabled.

Comments:

- Frequent state changes indicate that either the memory buffer size or age must be increased.
- If the memory buffer state is monitored infrequently (for example, once a minute) then the buffer might flip its state without it being registered.

zabbix[proxy_buffer,state,current]

Returns the current working state where the new data are being stored. Return values: 0 - disk; 1 - memory.

Comments:

- "0" is also returned when the memory buffer is disabled.

zabbix[proxy_history]

The number of values in the proxy history table waiting to be sent to the server. Return values: *Integer*.

Comments:

- This item is not supported on Zabbix server.

zabbix[queue,<from>,<to>]

The number of monitored items in the queue which are delayed at least by <from> seconds, but less than <to> seconds. Return value: *Integer*.

Parameters:

- **from** - delayed by at least (default is 6 seconds);
- **to** - delayed by at most (default is infinity).

Comments:

- **Time suffixes** (s,m,h,d,w) are supported in the parameters.

zabbix[rcache,<cache>,<mode>]

The availability statistics of the Zabbix configuration cache. Return values: *Integer* (for size); *Float* (for percentage).

Parameters:

- **cache** - *buffer*;
- **mode** - *total* - the total size of buffer;
free - the size of free buffer;
pfree - the percentage of free buffer;
used - the size of used buffer;
pused - the percentage of used buffer.

zabbix[requiredperformance]

The required performance of Zabbix server or Zabbix proxy, in new values per second expected. Return value: *Float*.

Comments:

- Approximately correlates with "Required server performance, new values per second" in *Reports* → *System information*.

zabbix[stats,<ip>,<port>]

The internal metrics of a remote Zabbix server or proxy. Return values: *JSON object*.

Parameters:

- **ip** - the IP/DNS/network mask list of servers/proxies to be remotely queried (default is 127.0.0.1);
- **port** - the port of server/proxy to be remotely queried (default is 10051).

Comments:

- The stats request will only be accepted from the addresses listed in the 'StatsAllowedIP' *server/proxy* parameter on the target instance.
- A selected set of internal metrics is returned by this item. For details, see [Remote monitoring of Zabbix stats](#).

`zabbix[stats,<ip>,<port>,queue,<from>,<to>]`

 The internal queue metrics (see `zabbix[queue,<from>,<to>]`) of a remote Zabbix server or proxy.
 Return values: *JSON object*.

Parameters:

- **ip** - the IP/DNS/network mask list of servers/proxies to be remotely queried (default is 127.0.0.1);
- **port** - the port of server/proxy to be remotely queried (default is 10051);
- **from** - delayed by at least (default is 6 seconds);
- **to** - delayed by at most (default is infinity).

Comments:

- The stats request will only be accepted from the addresses listed in the 'StatsAllowedIP' *server/proxy* parameter on the target instance.
- A selected set of internal metrics is returned by this item. For details, see [Remote monitoring of Zabbix stats](#).

`zabbix[tcache,<cache>,<parameter>]`

 The effectiveness statistics of the Zabbix trend function cache.
 Return values: *Integer* (for size); *Float* (for percentage).

Parameters:

- **cache** - *buffer*;
- **mode** - *all* - total cache requests (default);
hits - cache hits;
phits - percentage of cache hits;
misses - cache misses;
pmisses - percentage of cache misses;
items - the number of cached items;
requests - the number of cached requests;
pitems - percentage of cached items from cached items + requests. Low percentage most likely means that the cache size can be reduced.

Comments:

- This item is not supported on Zabbix proxy.

zabbixtriggers

 The number of enabled triggers in Zabbix database, with all items enabled on enabled hosts.
 Return value: *Integer*.

Comments:

- This item is not supported on Zabbix proxy.

`zabbix[uptime]`

 The uptime of the Zabbix server or proxy process in seconds.
 Return value: *Integer*.

`zabbix[vcache,buffer,<mode>]`

 The availability statistics of the Zabbix value cache.
 Return values: *Integer* (for size); *Float* (for percentage).

Parameters:

- **mode** - *total* - the total size of buffer;
free - the size of free buffer;
pfree - the percentage of free buffer;
used - the size of used buffer;
pused - the percentage of used buffer.

Comments:

- This item is not supported on Zabbix proxy.

`zabbix[vcache,cache,<parameter>]`

 The effectiveness statistics of the Zabbix value cache.
 Return values: *Integer*. With the *mode* parameter returns: 0 - normal mode; 1 - low memory mode.

Parameters:

- **parameter** - *requests* - the total number of requests;
hits - the number of cache hits (history values taken from the cache);
misses - the number of cache misses (history values taken from the database);
mode - the value cache operating mode.

Comments:

- Once the low-memory mode has been switched on, the value cache will remain in this state for 24 hours, even if the problem that triggered this mode is resolved sooner.

- You may use this key with the *Change per second* preprocessing step in order to get values-per-second statistics.
- This item is not supported on Zabbix proxy.

`zabbixversion`

 The version of Zabbix server or proxy.
 Return value: *String*. For example: 7.2.0.

`zabbix[vmware,buffer,<mode>]`

 The availability statistics of the Zabbix vmware cache.
 Return values: *Integer* (for size); *Float* (for percentage).

Parameters:

- **mode** - *total* - the total size of buffer;
free - the size of free buffer;
pfree - the percentage of free buffer;
used - the size of used buffer;
pused - the percentage of used buffer.

`zabbix[vps,written]`

 The total number of history values written to database.
 Return value: *Integer*.

`zabbix[wcache,<cache>,<mode>]`

 The statistics and availability of the Zabbix write cache.
 Return values: *Integer* (for number/size); *Float* (for percentage).

Parameters:

- **cache** - *values*, *history*, *index*, or *trend*;
- **mode** - (with *values*) *all* (default) - the total number of values processed by Zabbix server/proxy, except unsupported items (counter);
float - the number of processed float values (counter);
uint - the number of processed unsigned integer values (counter);
str - the number of processed character/string values (counter);
log - the number of processed log values (counter);
text - the number of processed text values (counter);
not supported - the number of times item processing resulted in item becoming unsupported or keeping that state (counter);
(with *history*, *index*, *trend* cache) *pfree* (default) - the percentage of free buffer;
total - the total size of buffer;
free - the size of free buffer;
used - the size of used buffer;
pused - the percentage of used buffer.

Comments:

- Specifying <cache> is mandatory. The *trend* cache parameter is not supported with Zabbix proxy.
- The history cache is used to store item values. A low number indicates performance problems on the database side.
- The history index cache is used to index the values stored in the history cache.
- After the history cache is filled and then cleared, the history index cache will still keep some data. This behavior is expected and helps the system run more efficiently by avoiding the extra processing required to constantly resize the memory.
- The trend cache stores the aggregate for the current hour for all items that receive data.
- You may use the `zabbix[wcache,values]` key with the *Change per second* preprocessing step in order to get values-per-second statistics.

9 SSH checks

Overview

SSH checks are performed as agent-less monitoring. Zabbix agent is not needed for SSH checks.

To perform SSH checks Zabbix server must be initially **configured** with SSH2 support (`libssh` or `libssh2`). See also: **Requirements**.

Attention:

Starting with RHEL 8, only `libssh` is supported. For other distributions, `libssh` is suggested over `libssh2`.

Configuration

Passphrase authentication

SSH checks provide two authentication methods - a user/password pair and key-file based.

If you do not intend to use keys, no additional configuration is required, besides linking `libssh` or `libssh2` to Zabbix, if you're building from source.

Key file authentication

To use key based authentication for SSH items, certain changes to the server configuration are required.

Open the Zabbix server configuration file (`zabbix_server.conf`) as `root` and look for the following line:

```
##### SSHKeyLocation=
```

Uncomment it and set the full path to the folder where the public and private keys will be located:

```
SSHKeyLocation=/home/zabbix/.ssh
```

Save the file and restart Zabbix server afterwards.

The path `/home/zabbix` here is the home directory for the `zabbix` user account, and `.ssh` is a directory where by default public and private keys will be generated by an `ssh-keygen` command inside the home directory.

Usually installation packages of Zabbix server from different OS distributions create the `zabbix` user account with a home directory elsewhere, for example, `/var/lib/zabbix` (as for system accounts).

Before generating the keys, you could reallocate the home directory to `/home/zabbix`, so that it corresponds with the `SSHKeyLocation` Zabbix server configuration parameter mentioned above.

Note:

The following steps can be skipped if `zabbix` account has been added manually according to the [installation section](#). In such a case the home directory for the `zabbix` account is most likely already `/home/zabbix`.

To change the home directory of the `zabbix` user account, all working processes which are using it have to be stopped:

```
systemctl stop zabbix-agent
systemctl stop zabbix-server
```

To change the home directory location with an attempt to move it (if it exists) the following command should be executed:

```
usermod -m -d /home/zabbix zabbix
```

It is also possible that a home directory did not exist in the old location, so it should be created at the new location. A safe attempt to do that is:

```
test -d /home/zabbix || mkdir /home/zabbix
```

To be sure that all is secure, additional commands could be executed to set permissions to the home directory:

```
chown zabbix:zabbix /home/zabbix
chmod 700 /home/zabbix
```

Previously stopped processes can now be started again:

```
systemctl start zabbix-agent
systemctl start zabbix-server
```

Now, the steps to generate the public and private keys can be performed with the following commands (for better readability, command prompts are commented out):

```
sudo -u zabbix ssh-keygen -t rsa
##### Generating public/private rsa key pair.
##### Enter file in which to save the key (/home/zabbix/.ssh/id_rsa):
/home/zabbix/.ssh/id_rsa
##### Enter passphrase (empty for no passphrase):
<Leave empty>
##### Enter same passphrase again:
<Leave empty>
##### Your identification has been saved in /home/zabbix/.ssh/id_rsa.
##### Your public key has been saved in /home/zabbix/.ssh/id_rsa.pub.
##### The key fingerprint is:
##### 90:af:e4:c7:e3:f0:2e:5a:8d:ab:48:a2:0c:92:30:b9 zabbix@it0
##### The key's randomart image is:
##### +--[ RSA 2048 ]-----+
##### |          |
##### |      .    |
##### |     o    |
##### | .     o  |
##### |+    . S  |
##### |.+   o =  |
##### |E .   * =  |
```



```
##### |=o . . .* . |
##### |... oo.o+ |
##### +-----+
```

Note:

The public and private keys (*id_rsa.pub* and *id_rsa*) have been generated by default in the */home/zabbix/.ssh* directory, which corresponds to the Zabbix server *SSHKeyLocation* configuration parameter.

Attention:

Key types other than "rsa" may be supported by the *ssh-keygen* tool and SSH servers but they may not be supported by *libssh2* used by Zabbix.

Shell configuration form

This step should be performed only once for every host that will be monitored by SSH checks.

By using the following commands, the **public** key file can be installed on a remote host *10.10.10.10*, so that the SSH checks can be performed with a *root* account (for better readability, command prompts are commented out):

```
sudo -u zabbix ssh-copy-id root@10.10.10.10
##### The authenticity of host '10.10.10.10 (10.10.10.10)' can't be established.
##### RSA key fingerprint is 38:ba:f2:a4:b5:d9:8f:52:00:09:f7:1f:75:cc:0b:46.
##### Are you sure you want to continue connecting (yes/no)?
yes
##### Warning: Permanently added '10.10.10.10' (RSA) to the list of known hosts.
##### root@10.10.10.10's password:
<Enter root password>
##### Now try logging into the machine, with "ssh 'root@10.10.10.10'",
##### and check to make sure that only the key(s) you wanted were added.
```

Now it is possible to check the SSH login using the default private key (*/home/zabbix/.ssh/id_rsa*) for the *zabbix* user account:

```
sudo -u zabbix ssh root@10.10.10.10
```

If the login is successful, then the configuration part in the shell is finished and the remote SSH session can be closed.

Item configuration

Actual command(s) to be executed must be placed in the *Executed script* field in the item configuration. Multiple commands can be executed one after another by placing them on a new line. In this case returned values will also be formatted as multilined.

* Name

Type

* Key

Type of information

Host interface

Authentication method

* User name

* Public key file

* Private key file

Key passphrase

* Executed script

* Update interval

All mandatory input fields are marked with a red asterisk.

The fields that require specific information for SSH items are:

Parameter	Description	Comments
Type	Select SSH agent here.	

Parameter	Description	Comments
Key	Unique (per host) item key in the format ssh.run[unique short description,<ip>,<port>,<encoding>,<ssh options>,<subsystem>]	<p>unique short description is required and should be unique for each SSH item per host.</p> <p>Default port is 22, not the port specified in the interface to which this item is assigned.</p> <p>ssh options allow to pass additional SSH options in the format <i>key1=value1;key2=value2,value3</i>. Multiple values for one key can be passed separated by comma (in this case, the parameter must be quoted); multiple option keys can be passed separated by semicolon.</p> <p>The following option keys are supported: KexAlgorithms, HostkeyAlgorithms, Ciphers, MACs, PubkeyAcceptedKeyTypes. Option key and value support depends on the SSH library (for example, PubkeyAcceptedKeyTypes is supported only with libssh); if an option is not supported, an error will be returned, and the item will become unsupported.</p> <p>Note that "+" sign for appending cipher settings and "!" for disabling specific cipher settings (as in GnuTLS and OpenSSL) are not supported.</p> <p>Examples:</p> <pre>=> ssh.run[KexAlgorithms,127.0.0.1,,Ciphers=aes128-ctr] => ssh.run[KexAlgorithms,,,"KexAlgorithms=diffie-hellman-gex-sha1"] => ssh.run[PubkeyAcceptedKeyTypes,127.0.0.1,,PubkeyAcceptedKeyTypes=ssh-rsa]</pre> <p>subsystem allows to pass an SSH subsystem, limiting the SSH connection to specific operations permitted by the subsystem (e.g., file transfers using SFTP or network device management using NETCONF). Note that using a subsystem may also require the use of specific script syntax in the <i>Executed script</i> parameter.</p> <p>Examples:</p> <pre>=> ssh.run[SFTPBackup,192.0.2.18,,,sftp] => ssh.run[Cisco1234,192.0.2.18,,,,netconf]</pre>
<i>Authentication method</i>	One of the "Password" or "Public key".	
<i>User name</i>	User name (up to 255 characters) to authenticate on remote host. Required.	
<i>Public key file</i>	File name of public key if <i>Authentication method</i> is "Public key". Required.	Example: <i>id_rsa.pub</i> - default public key file name generated by a command ssh-keygen .
<i>Private key file</i>	File name of private key if <i>Authentication method</i> is "Public key". Required.	Example: <i>id_rsa</i> - default private key file name.
<i>Password or Key passphrase</i>	Password (up to 255 characters) to authenticate or Passphrase if it was used for the private key.	Leave the <i>Key passphrase</i> field empty if passphrase was not used. See also known issues regarding passphrase usage.

Parameter	Description	Comments
<i>Executed script</i>	Executed shell command(s) using SSH remote session.	<p>The return value of the executed shell command(s) is limited to 16MB (including trailing whitespace that is truncated); database limits also apply.</p> <p>Note that the libssh2 library may truncate executable scripts to ~32kB.</p> <p>Examples:</p> <pre>date +%s systemctl status mysql-server ps auxww \ grep httpd \ wc -l</pre> <p>Example (for NETCONF subsystem):</p> <pre><rpc> <get-software-information/> </rpc>]]>]]> <rpc> <close-session/> </rpc>]]>]]></pre>

10 Telnet checks

Overview

Telnet checks are performed as agent-less monitoring. Zabbix agent is not needed for Telnet checks.

Configurable fields

Actual command(s) to be executed must be placed in the **Executed script** field in the item configuration.

Multiple commands can be executed one after another by placing them on a new line. In this case returned value also will be formatted as multiline.

Supported characters that the shell prompt can end with:

- \$
- #
- >
- %

Note:

A telnet prompt line which ended with one of these characters will be removed from the returned value, but only for the first command in the commands list, i.e. only at a start of the telnet session.

Key	Description
telnet.run[<unique short description>,<ip>,<port>,<encoding>]	Run a command on a remote device using telnet connection

Attention:

If a telnet check returns a value with non-ASCII characters and in non-UTF8 encoding then the *<encoding>* parameter of the key should be properly specified. See [encoding of returned values](#) page for more details.

11 External checks

Overview

External check is a check executed by Zabbix server by **running a shell script** or a binary. However, when hosts are monitored by a Zabbix proxy, the external checks are executed by the proxy.

External checks do not require any agent running on a host being monitored.

The syntax of the item key is:

```
script [<parameter1>, <parameter2>, ...]
```

Where:

ARGUMENT	DEFINITION
script	Name of a shell script or a binary.
parameter(s)	Optional command line parameters.

If you don't want to pass any parameters to the script you may use:

```
script [] or  
script
```

Zabbix server or proxy will search the directory specified for external scripts and execute the command (see `ExternalScripts` parameter in Zabbix `server/proxy` configuration file). The command will be executed under the same user as Zabbix server/proxy, so any access permissions or environment variables should be handled in a wrapper script, if necessary. Permissions on the command should also allow that user to execute it. Only commands in the specified directory are available for execution.

Warning:

Do not overuse external checks, as each script requires starting a fork process by Zabbix server/proxy, and running many scripts can significantly decrease Zabbix performance.

Usage example

Executing the script `check_oracle.sh` with the first parameters `'-h'`. The second parameter will be replaced by IP address or DNS name, depending on the selection in the host properties.

```
check_oracle.sh ["-h", "{HOST.CONN}"]
```

Assuming host is configured to use IP address, Zabbix server/proxy will execute:

```
check_oracle.sh '-h' '192.168.1.4'
```

External check result

The return value of an external check is a standard output together with a standard error produced by the check.

Attention:

An item that returns text (character, log, or text type of information) will not become unsupported in case of a standard error output.

The return value is limited to 16MB (including trailing whitespace that is truncated); `database limits` also apply.

If the requested script is not found or Zabbix server/proxy has no permissions to execute it, the item will become unsupported and a corresponding error message will be displayed.

In case of a timeout, the item will become unsupported, a corresponding error message will be displayed, and the process forked for the script will be terminated.

12 Trapper items

Overview

Trapper items accept incoming data instead of querying for it. This is useful for any data you want to send to Zabbix.

Note:

It is recommended to **install MIB files** to ensure that item values are displayed in the correct format. Without the MIB files, formatting issues, such as displaying values in HEX instead of UTF-8 or vice versa, may occur.

Configuration

To configure a trapper item:

1. Go to *Data collection* → *Hosts*.
2. Click *Items* in the row of the host.
3. Click *Create item*.
4. Enter item parameters in the configuration form.

The screenshot shows the 'Preprocessing' tab of the Zabbix item configuration form. The fields are as follows:

- Name:** Trapper item (mandatory, marked with a red asterisk)
- Type:** Zabbix trapper (dropdown menu)
- Key:** trap (mandatory, marked with a red asterisk)
- Type of information:** Text (dropdown menu)
- History:** Do not store, Store up to 31d (radio buttons)
- Allowed hosts:** (empty text input field)
- Populates host inventory field:** -None- (dropdown menu)
- Description:** (empty text area)
- Enabled:**

Buttons at the bottom: Add (blue), Test (grey), Cancel (blue).

All mandatory input fields are marked with a red asterisk.

The fields that require specific information for trapper items are:

<i>Type</i>	Select "Zabbix trapper".
<i>Key</i>	Enter a key that will be used to recognize the item when sending data to Zabbix server.
<i>Type of information</i>	Select the type of information that will correspond to the format of data that will be sent.
<i>Allowed hosts</i>	List of comma-delimited IP addresses (optionally in CIDR notation) or DNS names.
	If specified, incoming connections will be accepted only from the hosts listed here.
	If IPv6 support is enabled then '127.0.0.1', '::127.0.0.1', '::ffff:127.0.0.1' are treated equally and '::/0' will allow any IPv4 or IPv6 address. '0.0.0.0/0' can be used to allow any IPv4 address.
	Note that "IPv4-compatible IPv6 addresses" (0000::/96 prefix) are supported but deprecated by RFC4291 .
	Example: 127.0.0.1, 192.168.1.0/24, 192.168.3.1-255, 192.168.1-10.1-255, ::1,2001:db8::/32, mysqlserver1, zabbix.example.com, {HOST.HOST}
	Spaces, user macros , and host macros {HOST.HOST}, {HOST.NAME}, {HOST.IP}, {HOST.DNS}, {HOST.CONN} are supported.

Note:

Before sending values, you may have to wait up to 60 seconds after saving the item until Zabbix server picks up the changes from a configuration cache update.

Sending data

Sending data to Zabbix server or proxy is possible using the **Zabbix sender** utility or Zabbix sender **protocol**. Sending data to Zabbix server is also possible using the **history.push** API method.

Zabbix sender

For sending data to Zabbix server or proxy using the Zabbix sender utility, you could run the following command to send the "test value":

```
zabbix_sender -z <server IP address> -p 10051 -s "New host" -k trap -o "test value"
```

To send the "test value", the following command options are used:

- `-z` to specify Zabbix server IP address
- `-p` to specify Zabbix server port number (10051 by default)
- `-s` to specify the host (make sure to use the technical instead of the visible `host name`)
- `-k` to specify the key of the item `configured` in the trapper item
- `-o` to specify the value to send

Attention:

The Zabbix trapper process does not expand macros used in the item key to check the corresponding item key existence for the targeted host.

For more information on the communication between Zabbix sender and Zabbix server or proxy, see [Zabbix sender protocol](#).

history.push

For sending data to Zabbix server using the `history.push` API method, you could make the following HTTP POST request containing some test values:

```
curl --request POST \
  --url 'https://example.com/zabbix/api_jsonrpc.php' \
  --header 'Authorization: Bearer 0424bd59b807674191e7d77572075f33' \
  --header 'Content-Type: application/json-rpc' \
  --data '{"jsonrpc":"2.0","method":"history.push","params":[{"itemid":10600,"value":"test value 1"},{"ite
```

If the request is correct, the response returned by API could look as follows:

```
{
  "jsonrpc": "2.0",
  "result": {
    "response": "success",
    "data": [
      {
        "itemid": "10600"
      },
      {
        "itemid": "10601",
        "error": "Item is disabled."
      },
      {
        "error": "No permissions to referred object or it does not exist."
      }
    ]
  },
  "id": 1
}
```

Errors in response data indicate that sending data for specific items has failed validation by Zabbix server. This can happen for the following reasons:

- the user sending the data has *no read* permission to the item's host;
- the host is disabled or in maintenance without data collection;
- the item does not exist or is not yet included in the server configuration cache;
- the item is disabled or its type is other than Zabbix trapper or **HTTP agent** (with trapping enabled);
- the user's IP or DNS is not set in the item's *Allowed hosts* list;
- another item has a value with a duplicate timestamp on the nanosecond level.

The absence of errors indicates that the values sent have been accepted for processing, which includes preprocessing (if any), trigger processing, and saving to the database. Note that the processing of an accepted value may also fail (for example, during **preprocessing**), resulting in the value being discarded.

For more information on how to work with Zabbix API, see [API](#).

Displaying data

Once data is sent, you can navigate to *Monitoring* → *Latest data* to see the result:

☰ Latest data

Subfilter affects only filtered data					
HOSTS					
New host 1					
DATA					
With data Without data					
<input type="checkbox"/>	Host	Name ▲	Last check	Last value	Change
<input type="checkbox"/>	New host	Trapper item	2m 27s	test value	

Note:

If a single numeric value is sent, the data **graph** will show a horizontal line to the left and right of the value's time point.

13 JMX monitoring

Overview

JMX monitoring can be used to monitor JMX counters of a Java application.

JMX monitoring has native support in Zabbix in the form of a Zabbix daemon called "Zabbix Java gateway".

To retrieve the value of a particular JMX counter on a host, Zabbix server queries the Zabbix **Java gateway**, which in turn uses the [JMX management API](#) to query the application of interest remotely.

For more details and setup see the [Zabbix Java gateway](#) section.

Warning:

Communication between Java gateway and the monitored JMX application should not be firewalled.

Enabling remote JMX monitoring for Java application

A Java application does not need any additional software installed, but it needs to be started with the command-line options specified below to have support for remote JMX monitoring.

As a bare minimum, if you just wish to get started by monitoring a simple Java application on a local host with no security enforced, start it with these options:

```
java \  
-Dcom.sun.management.jmxremote \  
-Dcom.sun.management.jmxremote.port=12345 \  
-Dcom.sun.management.jmxremote.authenticate=false \  
-Dcom.sun.management.jmxremote.ssl=false \  
-Dcom.sun.management.jmxremote.registry.ssl=false \  
-jar /usr/share/doc/openjdk-6-jre-headless/demo/jfc/Notepad/Notepad.jar
```

This makes Java listen for incoming JMX connections on port 12345, from local host only, and tells it not to require authentication or SSL.

If you want to allow connections on another interface, set the `-Djava.rmi.server.hostname` parameter to the IP of that interface.

If you wish to be more stringent about security, there are many other Java options available to you. For instance, the next example starts the application with a more versatile set of options and opens it to a wider network, not just local host.

```
java \  
-Djava.rmi.server.hostname=192.168.3.14 \  
-Dcom.sun.management.jmxremote \  
-Dcom.sun.management.jmxremote.port=12345 \  
-Dcom.sun.management.jmxremote.authenticate=true \  
-Dcom.sun.management.jmxremote.password.file=/etc/java-6-openjdk/management/jmxremote.password \  
-Dcom.sun.management.jmxremote.access.file=/etc/java-6-openjdk/management/jmxremote.access \  
-Dcom.sun.management.jmxremote.ssl=true \  
-Dcom.sun.management.jmxremote.registry.ssl=true \  
-Djavax.net.ssl.keyStore=$YOUR_KEY_STORE \  
-Djavax.net.ssl.keyStorePassword=$YOUR_KEY_STORE_PASSWORD \  
-Djavax.net.ssl.trustStore=$YOUR_TRUST_STORE
```



```
-Djavax.net.ssl.trustStorePassword=$YOUR_TRUST_STORE_PASSWORD \
-Dcom.sun.management.jmxremote.ssl.need.client.auth=true \
-jar /usr/share/doc/openjdk-6-jre-headless/demo/jfc/Notepad/Notepad.jar
```

Most (if not all) of these settings can be specified in `/etc/java-6-openjdk/management/management.properties` (or wherever that file is on your system).

Note that if you wish to use SSL, you have to modify `startup.sh` script by adding `-Djavax.net.ssl.*` options to Java gateway, so that it knows where to find key and trust stores.

See [Monitoring and Management Using JMX](#) for a detailed description.

Configuring JMX interfaces and items in Zabbix frontend

With Java gateway running, server knowing where to find it and a Java application started with support for remote JMX monitoring, it is time to configure the interfaces and items in Zabbix GUI.

Configuring JMX interface

You begin by creating a JMX-type interface on the host of interest.

The screenshot shows the Zabbix GUI configuration page for a host. The 'Host' tab is active. The configuration includes:

- Host name:** JMX host (mandatory, marked with a red asterisk)
- Visible name:** JMX host
- Groups:** Java (new) (mandatory, marked with a red asterisk)
- Interfaces table:**

Interfaces	Type	IP address	DNS name	Connect to	Port
Agent		127.0.0.1		IP DNS	10050
JMX		127.0.0.1		IP DNS	12345

All mandatory input fields are marked with a red asterisk.

Adding JMX agent item

For each JMX counter you are interested in you add **JMX agent** item attached to that interface.

The key in the screenshot below says `jmx["java.lang:type=Memory", "HeapMemoryUsage.used"]`.

The screenshot shows the Zabbix GUI configuration page for a JMX agent item. The configuration includes:

- Name:** Used heap memory (mandatory, marked with a red asterisk)
- Type:** JMX agent
- Key:** `jmx["java.lang:type=Memory", "HeapMemoryUsage.used"]` (mandatory, marked with a red asterisk)
- Type of information:** Numeric (unsigned)
- Host interface:** 127.0.0.1:12345 (mandatory, marked with a red asterisk)
- JMX endpoint:** `service:jmx:rmi:///jndi/rmi://{HOST.CONN}:{HOST.PORT}/jmxrmi` (mandatory, marked with a red asterisk)
- User name:** {JMX_USERNAME}
- Password:** {JMX_PASSWORD}
- Units:** (empty)
- Update interval:** 1m (mandatory, marked with a red asterisk)

All mandatory input fields are marked with a red asterisk.

The fields that require specific information for JMX items are:

<i>Type</i>	Set JMX agent here.
<i>Key</i>	The <code>jmx[]</code> item key contains three parameters: object name - the object name of an MBean attribute name - an MBean attribute name with optional composite data field names separated by dots unique short description - a unique description that allows multiple JMX items with the same object name and attribute name on the host (optional) See below for more detail on JMX item keys. You may discover MBeans and MBean attributes using a <code>jmx.discovery[]</code> low-level discovery item.
<i>JMX endpoint</i>	You may specify a custom JMX endpoint. Make sure that JMX endpoint connection parameters match the JMX interface. This can be achieved by using <code>{HOST.*}</code> macros as done in the default JMX endpoint. <code>{HOST.*}</code> macros and user macros are supported.
<i>User name</i>	Specify the user name (up to 255 characters), if you have configured authentication on your Java application. User macros are supported.
<i>Password</i>	Specify the password (up to 255 characters), if you have configured authentication on your Java application. User macros are supported.

If you wish to monitor a Boolean counter that is either "true" or "false", then you specify type of information as "Numeric (unsigned)" and select "Boolean to decimal" preprocessing step in the Preprocessing tab. Server will store Boolean values as 1 or 0, respectively.

JMX item keys in more detail

Simple attributes

An MBean object name is nothing but a string which you define in your Java application. An attribute name, on the other hand, can be more complex. In case an attribute returns primitive data type (an integer, a string etc.) there is nothing to worry about, the key will look like this:

```
jmx[com.example:Type=Hello,weight]
```

In this example the object name is "com.example:Type=Hello", the attribute name is "weight", and the returned value type should probably be "Numeric (float)".

Attributes returning composite data

It becomes more complicated when your attribute returns composite data. For example: your attribute name is "apple" and it returns a hash representing its parameters, like "weight", "color" etc. Your key may look like this:

```
jmx[com.example:Type=Hello,apple.weight]
```

This is how an attribute name and a hash key are separated, by using a dot symbol. Same way, if an attribute returns nested composite data the parts are separated by a dot:

```
jmx[com.example:Type=Hello,fruits.apple.weight]
```

Attributes returning tabular data

Tabular data attributes consist of one or multiple composite attributes. If such an attribute is specified in the attribute name parameter then this item value will return the complete structure of the attribute in JSON format. The individual element values inside the tabular data attribute can be retrieved using preprocessing.

Tabular data attribute example:

```
jmx[com.example:type=Hello,foodinfo]
```

Item value:

```
[
  {
    "a": "apple",
    "b": "banana",
    "c": "cherry"
  },
  {
    "a": "potato",
```

```
"b": "lettuce",
"c": "onion"
}
]
```

Problem with dots

So far so good. But what if an attribute name or a hash key contains dot symbol? Here is an example:

```
jmx[com.example:Type=Hello,all.fruits.apple.weight]
```

That's a problem. How to tell Zabbix that attribute name is "all.fruits", not just "all"? How to distinguish a dot that is part of the name from the dot that separates an attribute name and hash keys?

This is possible, all you need to do is to escape the dots that are part of the name with a backslash:

```
jmx[com.example:Type=Hello,all\.fruits.apple.weight]
```

Same way, if your hash key contains a dot you escape it:

```
jmx[com.example:Type=Hello,all\.fruits.apple.total\.weight]
```

Other issues

A backslash character in an attribute name should be escaped:

```
jmx[com.example:type=Hello,c:\\documents]
```

For handling any other special characters in JMX item key, please see the item key format [section](#).

This is actually all there is to it. Happy JMX monitoring!

Non-primitive data types

It is possible to work with custom MBeans returning non-primitive data types, which override the **toString()** method.

Using custom endpoint with JBoss EAP 6.4

Custom endpoints allow working with different transport protocols other than the default RMI.

To illustrate this possibility, let's try to configure JBoss EAP 6.4 monitoring as an example. First, let's make some assumptions:

- You have already installed Zabbix Java gateway. If not, then you can do it in accordance with the [documentation](#).
- Zabbix server and Java gateway are installed with the prefix `/usr/local/`
- JBoss is already installed in `/opt/jboss-eap-6.4/` and is running in standalone mode
- We shall assume that all these components work on the same host
- Firewall and SELinux are disabled (or configured accordingly)

Let's make some simple settings in `zabbix_server.conf`:

```
JavaGateway=127.0.0.1
StartJavaPollers=5
```

And in the `zabbix_java/settings.sh` configuration file (or `zabbix_java_gateway.conf`):

```
START_POLLERS=5
```

Check that JBoss listens to its standard management port:

```
$ netstat -natp | grep 9999
tcp        0      0 127.0.0.1:9999          0.0.0.0:*               LISTEN      10148/java
```

Now let's create a host with JMX interface `127.0.0.1:9999` in Zabbix.

Host Templates IPMI Tags Macros Inventory Encryption Value mapping

* Host name

Visible name

* Groups

Interfaces	Type	IP address	DNS name	Connect to	Port
Agent		<input type="text" value="127.0.0.1"/>	<input type="text"/>	<input type="button" value="IP"/> <input type="button" value="DNS"/>	<input type="text" value="10050"/>
JMX		<input type="text" value="127.0.0.1"/>	<input type="text"/>	<input type="button" value="IP"/> <input type="button" value="DNS"/>	<input type="text" value="9999"/>

[Add](#)

As we know that this version of JBoss uses the JBoss Remoting protocol instead of RMI, we may mass update the JMX endpoint parameter for items in our JMX template accordingly:

```
service:jmx:remoting-jmx://{HOST.CONN}:{HOST.PORT}
```

Mass update

Item Tags Preprocessing

Type Original

JMX endpoint

Let's update the configuration cache:

```
/usr/local/sbin/zabbix_server -R config_cache_reload
```

Note that you may encounter an error first.

```
3. mc [root@centos7-dev]:/home/vagrant/zabbix-3.2.6/src/zabbix_java (ssh)
com.zabbix.gateway.ZabbixException: java.net.MalformedURLException: Unsupported protocol: remoting-jmx
    at com.zabbix.gateway.JMXItemChecker.getValues(JMXItemChecker.java:97) ~[zabbix-java-gateway-3.4.2.jar:na]
    at com.zabbix.gateway.SocketProcessor.run(SocketProcessor.java:63) ~[zabbix-java-gateway-3.4.2.jar:na]
    at java.util.concurrent.ThreadPoolExecutor.runWorker(ThreadPoolExecutor.java:1149) [na:1.8.0_144]
    at java.util.concurrent.ThreadPoolExecutor$Worker.run(ThreadPoolExecutor.java:624) [na:1.8.0_144]
    at java.lang.Thread.run(Thread.java:748) [na:1.8.0_144]
Caused by: java.net.MalformedURLException: Unsupported protocol: remoting-jmx
    at javax.management.remote.JMXConnectorFactory.newJMXConnector(JMXConnectorFactory.java:359) ~[na:1.8.0_144]
    at javax.management.remote.JMXConnectorFactory.connect(JMXConnectorFactory.java:269) ~[na:1.8.0_144]
    at com.zabbix.gateway.ZabbixJMXConnectorFactory$1.run(ZabbixJMXConnectorFactory.java:76) ~[zabbix-java-gatewa
-3.4.2.jar:na]
    at java.util.concurrent.Executors$RunnableAdapter.call(Executors.java:511) ~[na:1.8.0_144]
    at java.util.concurrent.FutureTask.run(FutureTask.java:266) ~[na:1.8.0_144]
    .. 3 common frames omitted
2017-11-07 13:52:12.644 [pool-1-thread-1] WARN com.zabbix.gateway.SocketProcessor - error processing request
com.zabbix.gateway.ZabbixException: java.net.MalformedURLException: Unsupported protocol: remoting-jmx
    at com.zabbix.gateway.JMXItemChecker.getValues(JMXItemChecker.java:97) ~[zabbix-java-gateway-3.4.2.jar:na]
    at com.zabbix.gateway.SocketProcessor.run(SocketProcessor.java:63) ~[zabbix-java-gateway-3.4.2.jar:na]
    at java.util.concurrent.ThreadPoolExecutor.runWorker(ThreadPoolExecutor.java:1149) [na:1.8.0_144]
    at java.util.concurrent.ThreadPoolExecutor$Worker.run(ThreadPoolExecutor.java:624) [na:1.8.0_144]
    at java.lang.Thread.run(Thread.java:748) [na:1.8.0_144]
Caused by: java.net.MalformedURLException: Unsupported protocol: remoting-jmx
    at javax.management.remote.JMXConnectorFactory.newJMXConnector(JMXConnectorFactory.java:359) ~[na:1.8.0_144]
    at javax.management.remote.JMXConnectorFactory.connect(JMXConnectorFactory.java:269) ~[na:1.8.0_144]
    at com.zabbix.gateway.ZabbixJMXConnectorFactory$1.run(ZabbixJMXConnectorFactory.java:76) ~[zabbix-java-gatewa
-3.4.2.jar:na]
    at java.util.concurrent.Executors$RunnableAdapter.call(Executors.java:511) ~[na:1.8.0_144]
    at java.util.concurrent.FutureTask.run(FutureTask.java:266) ~[na:1.8.0_144]
    .. 3 common frames omitted
2017-11-07 13:52:14.889 [Thread-0] INFO com.zabbix.gateway.JavaGateway - Zabbix Java Gateway 3.4.2 (revision 72885)
as stopped
2017-11-07 13:52:26.167 [main] INFO com.zabbix.gateway.JavaGateway - Zabbix Java Gateway 3.4.2 (revision 72885) has
tarted
```

"Unsupported protocol: remoting-jmx" means that Java gateway does not know how to work with the specified protocol. That can be fixed by creating a `~/needed_modules.txt` file with the following content:

```
jboss-as-remoting
jboss-logging
jboss-logmanager
jboss-marshalling
jboss-remoting
jboss-sasl
jcl-over-slf4j
jul-to-slf4j-stub
log4j-jboss-logmanager
remoting-jmx
slf4j-api
xnio-api
xnio-nio
```

and then executing the command:

```
for i in $(cat ~/needed_modules.txt); do find /opt/jboss-eap-6.4 -iname "${i}*.jar" -exec cp '{}' /usr/local/lib/; done
```

Thus, Java gateway will have all the necessary modules for working with jmx-remoting. What's left is to restart the Java gateway, wait a bit and if you did everything right, see that JMX monitoring data begin to arrive in Zabbix (see also: [Latest data](#)).

14 ODBC monitoring

Overview

ODBC monitoring corresponds to the **Database monitor** item type in the Zabbix frontend.

ODBC is a C programming language middle-ware API for accessing database management systems (DBMS). The ODBC concept was developed by Microsoft and later ported to other platforms.

Zabbix may query any database, which is supported by ODBC. To do that, Zabbix does not directly connect to the databases, but uses the ODBC interface and drivers set up in ODBC. This allows for more efficient monitoring of different databases for multiple purposes (for example, checking specific database queues, usage statistics, etc.).

Zabbix supports unixODBC, which is one of the most commonly used open source ODBC API implementations.

Attention:

See also: [known issues](#) for ODBC checks.

Installing unixODBC

The suggested way of installing unixODBC is to use the Linux operating system default package repositories. In the most popular Linux distributions, unixODBC is included in the package repository by default. If packages are not available, the source files can be obtained at the unixODBC homepage: <http://www.unixodbc.org/download.html>.

To install unixODBC, use the package manager for the system of your choice:

```
##### For Ubuntu/Debian systems:
apt install unixodbc unixodbc-dev
```

```
##### For RedHat/Fedora-based systems:
dnf install unixODBC unixODBC-devel
```

```
##### For SUSE-based systems:
zypper in unixODBC-devel
```

Attention:

The `unixodbc-dev` or `unixODBC-devel` package is necessary to compile Zabbix with unixODBC support. To enable ODBC support, Zabbix should be compiled with the following **configuration option**: `

--with-unixodbc[=ARG] # Use ODBC driver against unixODBC package.`

Installing unixODBC drivers

The unixODBC database driver should be installed for the database that will be monitored. For a list of supported databases and drivers, see the unixODBC homepage: <http://www.unixodbc.org/drivers.html>.

Note:

In some Linux distributions, database drivers are included in package repositories.

MySQL

To install the MySQL unixODBC database driver, use the package manager for the system of your choice:

```
##### For Ubuntu/Debian systems:
apt install odbc-mariadb

##### For RedHat/Fedora-based systems:
dnf install mariadb-connector-odbc

##### For SUSE-based systems:
zypper install mariadb-connector-odbc
```

To install the database driver without a package manager, please refer to [MySQL documentation](#) for `mysql-connector-odbc`, or [MariaDB documentation](#) for `mariadb-connector-odbc`.

PostgreSQL

To install the PostgreSQL unixODBC database driver, use the package manager for the system of your choice:

```
##### For Ubuntu/Debian systems:
apt install odbc-postgresql

##### For RedHat/Fedora-based systems:
dnf install postgresql-odbc

##### For SUSE-based systems:
zypper install psqlODBC
```

To install the database driver without a package manager, please refer to [PostgreSQL documentation](#).

Oracle

To install the unixODBC database driver, please refer to [Oracle documentation](#).

MSSQL

To install the MSSQL unixODBC database driver for Ubuntu/Debian systems, use the package manager for the system of your choice:

```
##### For Ubuntu/Debian systems:
apt install tdsodbc

##### For RedHat/Fedora-based systems (EPEL packages: https://docs.fedoraproject.org/en-US/epel/):
dnf install epel-release
dnf install freetds

##### For SUSE-based systems:
zypper install libtdsodbc0
```

To install the database driver without a package manager, please refer to [FreeTDS user guide](#).

Configuring unixODBC

To configure unixODBC, you must edit the `odbcinst.ini` and `odbc.ini` files. You can verify the location of these files by executing the following command:

```
odbcinst -j
```

The command result should contain information that is similar to the following:

```
unixODBC 2.3.9
DRIVERS.....: /etc/odbcinst.ini
SYSTEM DATA SOURCES: /etc/odbc.ini
FILE DATA SOURCES...: /etc/ODBCDataSources
```

`odbcinst.ini`

The `odbcinst.ini` file lists the installed ODBC database drivers. If `odbcinst.ini` is missing, it is necessary to create it manually.

```
[TEST_MYSQL]
Description=ODBC for MySQL
Driver=/usr/lib/libmyodbc5.so
FileUsage=1
```

Parameter	Description
TEST_MYSQL	Database driver name.
Description	Database driver description.
Driver	Database driver library location.
FileUsage	Determines whether the database driver supports connecting to a database server without the support for accessing local files (0); supports reading data from files (1); supports writing data to files (2).
Threading	Thread serialization level. Supported for PostgreSQL. Since 1.6, if the driver manager is built with thread support, you may add another driver entry.

`odbc.ini`

The `odbc.ini` file is used to configure data sources.

```
[TEST_MYSQL]
Description=MySQL Test Database
Driver=mysql
Server=127.0.0.1
User=root
Password=
Port=3306
Socket=
Database=zabbix
```

Parameter	Description
TEST_MYSQL	Data source name (DSN).
Description	Data source description.
Driver	Database driver name (as specified in <code>odbcinst.ini</code>).
Server	Database server IP/DNS.
User	Database user for connection.
Password	Database user password.
Port	Database connection port.
Socket	Database connection socket.
Database	Database name.

For other possible configuration parameter options, see [MySQL documentation](#).

The `odbc.ini` file for PostgreSQL may contain additional parameters:

```
[TEST_PSQL]
Description=PostgreSQL Test Database
Driver=postgresql
Username=zbx_test
Password=zabbix
Servername=127.0.0.1
Database=zabbix
Port=5432
ReadOnly=No
Protocol=7.4+
ShowOidColumn=No
FakeOidIndex=No
RowVersioning=No
ShowSystemTables=No
Fetch=Yes
BoolsAsChar=Yes
```

SSLmode=Require
ConnSettings=

Parameter	Description
ReadOnly	Specifies whether the database connection allows only read operations (SELECT queries) and restricts modifications (INSERT, UPDATE, and DELETE statements); useful for scenarios where data should remain unchanged.
Protocol	PostgreSQL backend protocol version (ignored when using SSL connections).
ShowOidColumn	Specifies whether to include Object ID (OID) in SQLColumns.
FakeOidIndex	Specifies whether to create a fake unique index on OID.
RowVersioning	Specifies whether to enable applications to detect if data has been modified by other users while you are attempting to update a row. Note that this parameter can speed up the update process, since, to update a row, every single column does not need to be specified in the WHERE clause.
ShowSystemTables	Specifies whether the database driver should treat system tables as regular tables in SQLTables; useful for accessibility, allowing visibility into system tables.
Fetch	Specifies whether the driver should automatically use declare cursor/fetch to handle SELECT statements and maintain a cache of 100 rows.
BoolsAsChar	Controls the mapping of Boolean types. If set to "Yes", Booleans are mapped to SQL_CHAR; otherwise, they are mapped to SQL_BIT.
SSLmode	Specifies the SSL mode for the connection.
ConnSettings	Additional settings sent to the backend on connection.

Testing ODBC connection

To test if the ODBC connection is working successfully, you can use the `isql` utility (included in the `unixODBC` package):

```
isql test
+-----+
| Connected! |
|           |
| sql-statement |
| help [tablename] |
| quit |
|           |
+-----+
```

Item configuration in Zabbix frontend

Configure a **Database monitoring** item.

The screenshot shows the Zabbix frontend configuration page for a new item. The tabs 'Item', 'Tags', and 'Preprocessing' are visible at the top. The configuration fields are as follows:

- Name:** MySQL host count (marked with a red asterisk)
- Type:** Database monitor (dropdown menu)
- Key:** db.odbc.select[mysql-simple-check,test] (marked with a red asterisk) with a 'Select' button to the right.
- Type of information:** Numeric (unsigned) (dropdown menu)
- User name:** zabbix
- Password:** (empty text field)
- SQL query:** select count(*) from hosts (marked with a red asterisk)
- Units:** (empty text field)
- Update interval:** 1m (marked with a red asterisk)

All mandatory input fields are marked with a red asterisk.

For database monitoring items, you must specify:

<i>Type</i>	Select "Database monitor" here.
<i>Key</i>	Enter one of the supported item keys: db.odbc.select[] - this item returns one value (the first column of the first row of the SQL query result); db.odbc.get[] - this item returns multiple rows/columns in JSON format; db.odbc.discovery[] - this item returns low-level discovery data.
<i>User name</i>	Enter the database user name (up to 255 characters). This parameter is optional if the database user name is specified in the <code>odbc.ini</code> file. If a connection string is used, and the <i>User name</i> field is not empty, then it is appended to the connection string as <code>UID=<user></code> .
<i>Password</i>	Enter the database user password (up to 255 characters). This parameter is optional if the password is specified in the <code>odbc.ini</code> file. If a connection string is used, and the <i>Password</i> field is not empty, then it is appended to the connection string as <code>PWD=<password></code> . Special characters are supported in this field. The password will be appended to connection string after the username as, for example <code>UID=<username>;PWD=P?;)*word</code> . To test the resulting string, you can run the following command: <code>isql -v -k 'Driver=libmoadbc.so;Database=zabbix;UID=zabbix;PWD=P?;)*word'</code>
<i>SQL query</i>	Enter the SQL query.
<i>Type of information</i>	Note that with <code>db.odbc.select[]</code> , the query must return one value only. Select the type of information that will be returned by the query here. If the type of information is selected incorrectly, the item will become unsupported.

Important notes

- Database monitoring items will become unsupported if no *odbc poller* processes are started in the server or proxy configuration. To activate ODBC pollers, set the `StartODBCPollers` parameter in Zabbix *server* configuration file or, for checks performed by proxy, in Zabbix *proxy* configuration file.
- The *Timeout* parameter value in the *item configuration* form is used as the ODBC login timeout and the query execution timeout. Note that these timeout settings might be ignored if the installed ODBC driver does not support them.
- The SQL command must return a result set like any query using the `select` statement. The query syntax will depend on the RDBMS which will process them. The syntax of request to a storage procedure must be started with the `call` keyword.

Item key details

Parameters without angle brackets are mandatory. Parameters marked with angle brackets `< >` are optional.

`db.odbc.select[<unique short description>,<dsn>,<connection string>]`

`
` Returns one value, that is, the first column of the first row of the SQL query result.`
` Return value: Depending on the SQL query.

Parameters:

- **unique short description** - a unique short description to identify the item (for use in triggers, etc.);
- **dsn** - the data source name (as specified in `odbc.ini`);
- **connection string** - the connection string (may contain driver-specific arguments).

Comments:

- Although `dsn` and `connection string` are optional parameters, at least one of them is required; if both are defined, `dsn` will be ignored.
- If a query returns more than one column, only the first column is read. If a query returns more than one line, only the first line is read.

`db.odbc.get[<unique short description>,<dsn>,<connection string>]`

`
` Transforms the SQL query result into a JSON array.`
` Return value: *JSON object*.

Parameters:

- **unique short description** - a unique short description to identify the item (for use in triggers, etc.);
- **dsn** - the data source name (as specified in `odbc.ini`);
- **connection string** - the connection string (may contain driver-specific arguments).

Comments:

- Although `dsn` and `connection string` are optional parameters, at least one of them is required; if both are defined, `dsn` will be ignored.
- Multiple rows/columns in JSON format may be returned. This item may be used as a master item that collects all data in one system call, while `JSONPath` preprocessing may be used in dependent items to extract individual values. For more information, see an [example](#) of the returned format, used in low-level discovery.

Example:

```
# Connection for MySQL ODBC driver 5:
db.odbc.get[MySQL example,, "Driver=/usr/local/lib/libmyodbc5a.so;Database=master;Server=127.0.0.1;Port=3306"]
db.odbc.discovery[<unique short description>,<dsn>,<connection string>]
```

 Transforms the SQL query result into a JSON array, used for [low-level discovery](#). The column names from the query result are turned into low-level discovery macro names paired with the discovered field values. These macros can be used in creating item, trigger, etc. prototypes.
 Return value: *JSON object*.

Parameters:

- **unique short description** - a unique short description to identify the item (for use in triggers, etc.);
- **dsn** - the data source name (as specified in `odbc.ini`);
- **connection string** - the connection string (may contain driver-specific arguments).

Comments:

- Although `dsn` and `connection string` are optional parameters, at least one of them is required; if both are defined, `dsn` will be ignored.

Error messages

ODBC error messages are structured into fields to provide detailed information. For example, an error message might look like this:

```
Cannot execute ODBC query: [SQL_ERROR]:[42601][7][ERROR: syntax error at or near ";"; Error while executing the query]
```

- "Cannot execute ODBC query" - Zabbix message
- "[SQL_ERROR]" - ODBC return code
- "[42601]" - SQLState
- "[7]" - Native error code
- "[ERROR: syntax error at or near ";"; Error while executing the query]" - Native error message

Note that the error message length is limited to 2048 bytes, so the message can be truncated. If there is more than one ODBC diagnostic record, Zabbix tries to concatenate them (separated with `|`) as far as the length limit allows.

15 Dependent items

Overview

There are situations when one item gathers multiple metrics at a time or it even makes more sense to collect related metrics simultaneously, for example:

- CPU utilization of individual cores
- Incoming/outgoing/total network traffic

To allow for bulk metric collection and simultaneous use in several related items, Zabbix supports dependent items. Dependent items depend on the master item that collects their data simultaneously, in one query. A new value for the master item automatically populates the values of the dependent items. Dependent items cannot have a different update interval than the master item.

Zabbix preprocessing options can be used to extract the part that is needed for the dependent item from the master item data.

Preprocessing is managed by a `preprocessing manager` process, along with worker threads that perform the preprocessing steps. All values (with or without preprocessing) from different data gatherers pass through the preprocessing manager before being added to the history cache. Socket-based IPC communication is used between data gatherers (pollers, trappers, etc) and the preprocessing process.

Zabbix server or Zabbix proxy (if host is monitored by proxy) are performing preprocessing steps and processing dependent items.

Item of any type, even dependent item, can be set as master item. Additional levels of dependent items can be used to extract smaller parts from the value of an existing dependent item.

Limitations

- Only same host (template) dependencies are allowed
- An item prototype can depend on another item prototype or regular item from the same host
- Dependent item on a host with master item from template will not be exported to XML

Item configuration

A dependent item depends on its master item for data. That is why the **master item** must be configured (or exist) first:

- Go to: *Data collection* → *Hosts*
- Click on *Items* in the row of the host
- Click on *Create item*
- Enter parameters of the item in the form

The screenshot shows the 'Preprocessing' tab of the Zabbix item configuration form. The fields are as follows:

- Name:** Apache server status (marked with a red asterisk)
- Type:** Zabbix agent
- Key:** web.page.get[127.0.0.1/server-status] (marked with a red asterisk)
- Type of information:** Text
- Host interface:** 127.0.0.1:1050 (marked with a red asterisk)
- Update interval:** 30s (marked with a red asterisk)

All mandatory input fields are marked with a red asterisk.

Click on *Add* to save the master item.

Then you can configure a **dependent item**.

The screenshot shows the 'Preprocessing' tab of the Zabbix item configuration form for a dependent item. The fields are as follows:

- Name:** Apache server uptime (marked with a red asterisk)
- Type:** Dependent item
- Key:** apache.server.uptime (marked with a red asterisk)
- Type of information:** Text
- Master item:** Apache: Apache server status (marked with a red asterisk)

All mandatory input fields are marked with a red asterisk.

The fields that require specific information for dependent items are:

<i>Type</i>	Select Dependent item here.
<i>Key</i>	Enter a key that will be used to recognize the item.
<i>Master item</i>	Select the master item. Master item value will be used to populate dependent item value.
<i>Type of information</i>	Select the type of information that will correspond the format of data that will be stored.

You may use item value **preprocessing** to extract the required part of the master item value.

Item Tags Preprocessing 1

Preprocessing steps	Name	Parameters
1:	Regular expression	<dt>Server uptime: (.*)</dt>

Type of information: Text

Without preprocessing, the dependent item value will be exactly the same as the master item value.

Click on *Add* to save the dependent item.

A shortcut to creating a dependent item quicker can be accessed by clicking on the **...** button in the item list and selecting *Create dependent item*.

The screenshot shows a context menu for the item 'Apache server status'. The menu is divided into sections: VIEW (Latest data, Graph, Values, 500 latest values), CONFIGURATION (Item, Triggers, Create trigger, **Create dependent item**, Create dependent discovery rule), and ACTIONS (Execute now). The 'Create dependent item' option is highlighted.

Display

In the item list dependent items are displayed with their master item name as prefix.

	Name ▲	Triggers	Key
<input type="checkbox"/>	...		web.page.get[127.0.0.1/server-status]
<input type="checkbox"/>	...		apache.server.uptime

If a master item is deleted, so are all its dependent items.

16 HTTP agent

Overview

This item type allows data polling using the HTTP/HTTPS protocol. Trapping is also possible using the **Zabbix sender** utility or Zabbix sender **protocol** (for sending data to Zabbix server or proxy), or using the **history.push** API method (for sending data to Zabbix server).

HTTP item checks are executed by Zabbix server. However, when hosts are monitored by a Zabbix proxy, HTTP item checks are executed by the proxy.

HTTP item checks do not require any agent running on a host being monitored.

HTTP agent supports both HTTP and HTTPS. Zabbix will optionally follow redirects (see the *Follow redirects* option below). Maximum number of redirects is hard-coded to 10 (using cURL option CURLOPT_MAXREDIRS).

Attention:

Zabbix server/proxy must be initially configured with cURL (libcurl) support.

HTTP checks are executed asynchronously - it is not required to receive the response to one request before other checks are started. DNS resolving is asynchronous as well.

The maximum concurrency of asynchronous checks is 1000 (defined by `MaxConcurrentChecksPerPoller`).

The number of asynchronous HTTP agent pollers is defined by the `StartHTTPAgentPollers` parameter.

The persistent connections cURL feature has been added to HTTP agent checks since Zabbix 7.0.

Configuration

To configure an HTTP item:

- Go to: *Data collection* → *Hosts*
- Click on *Items* in the row of the host
- Click on *Create item*
- Enter parameters of the item in the form

* Name

Type

* Key

Type of information

* URL

Name	Value
<input type="text" value="scroll"/>	<input type="text" value="10s"/>

[Remove](#)
[Add](#)

Request type

Request body type

Request body

```
{
  "query":{
    "bool":{
      "must":{
        "match":{
          "itemid":28275
        }
      }
    }
  }
}
```

Name	Value
<input type="text" value="name"/>	<input type="text" value="value"/>

[Remove](#)
[Add](#)

Required status codes

Follow redirects

Retrieve mode

Convert to JSON

HTTP proxy

HTTP authentication

SSL verify peer

SSL verify host

SSL certificate file

SSL key file

SSL key password

Host interface

Units

* Update interval

Type	Interval	Period	Action
<input type="text" value="Flexible"/> <input checked="" type="text" value="Scheduling"/>	<input type="text" value="50s"/>	<input type="text" value="1-7,00:00-24:00"/>	Remove

[Add](#)

* Timeout [Timeouts](#)

* History

* Trends

Value mapping

Enable trapping

Populates host inventory field

Description

Enabled

All mandatory input fields are marked with a red asterisk.

The fields that require specific information for HTTP items are:

Parameter	Description
<i>Type</i>	Select HTTP agent here.
<i>Key</i>	Enter a unique item key.
<i>URL</i>	<p>URL to connect to and retrieve data. For example: https://www.example.com http://www.example.com/download</p> <p>Domain names can be specified in Unicode characters. They are automatically punycode-converted to ASCII when executing the HTTP check.</p> <p>The <i>Parse</i> button can be used to separate optional query fields (like <code>?name=Admin&password=myspassword</code>) from the URL, moving the attributes and values into <i>Query fields</i> for automatic URL-encoding.</p> <p>Limited to 2048 characters.</p> <p>Supported macros: {HOST.IP}, {HOST.CONN}, {HOST.DNS}, {HOST.HOST}, {HOST.NAME}, {HOST.PORT}, {ITEM.ID}, {ITEM.KEY}, {ITEM.KEY.ORIG}, user macros, low-level discovery macros.</p>
<i>Query fields</i>	<p>This sets the CURLOPT_URL cURL option.</p> <p>Variables for the URL (see above).</p> <p>Specified as attribute and value pairs.</p> <p>Values are URL-encoded automatically. Values from macros are resolved and then URL-encoded automatically.</p> <p>Supported macros: {HOST.IP}, {HOST.CONN}, {HOST.DNS}, {HOST.HOST}, {HOST.NAME}, {HOST.PORT}, {ITEM.ID}, {ITEM.KEY}, {ITEM.KEY.ORIG}, user macros, low-level discovery macros.</p>
<i>Request type</i>	Select request method type: <i>GET</i> , <i>POST</i> , <i>PUT</i> or <i>HEAD</i>
<i>Request body type</i>	<p>Select the request body type:</p> <p>Raw data - custom HTTP request body, macros are substituted but no encoding is performed</p> <p>JSON data - HTTP request body in JSON format. Macros can be used as string, number, true and false; macros used as strings must be enclosed in double quotes. Values from macros are resolved and then escaped automatically. If "Content-Type" is not specified in headers then it will default to "Content-Type: application/json"</p> <p>XML data - HTTP request body in XML format. Macros can be used as a text node, attribute or CDATA section. Values from macros are resolved and then escaped automatically in a text node and attribute. If "Content-Type" is not specified in headers then it will default to "Content-Type: application/xml"</p> <p><i>Note that selecting XML data requires libxml2.</i></p>
<i>Request body</i>	<p>Enter the request body.</p> <p>Supported macros: {HOST.IP}, {HOST.CONN}, {HOST.DNS}, {HOST.HOST}, {HOST.NAME}, {HOST.PORT}, {ITEM.ID}, {ITEM.KEY}, {ITEM.KEY.ORIG}, user macros, low-level discovery macros.</p>
<i>Headers</i>	<p>Custom HTTP headers that will be sent when performing a request.</p> <p>Specified as attribute and value pairs.</p> <p>Supported macros: {HOST.IP}, {HOST.CONN}, {HOST.DNS}, {HOST.HOST}, {HOST.NAME}, {HOST.PORT}, {ITEM.ID}, {ITEM.KEY}, {ITEM.KEY.ORIG}, user macros, low-level discovery macros.</p>
<i>Required status codes</i>	<p>This sets the CURLOPT_HTTPHEADER cURL option.</p> <p>List of expected HTTP status codes. If Zabbix gets a code which is not in the list, the item will become unsupported. If empty, no check is performed.</p> <p>For example: 200,201,210-299</p> <p>Supported macros in the list: user macros, low-level discovery macros.</p>
<i>Follow redirects</i>	<p>This uses the CURLINFO_RESPONSE_CODE cURL option.</p> <p>Mark the checkbox to follow HTTP redirects.</p>
<i>Retrieve mode</i>	<p>This sets the CURLOPT_FOLLOWLOCATION cURL option.</p> <p>Select the part of response that must be retrieved:</p> <p>Body - body only</p> <p>Headers - headers only</p> <p>Body and headers - body and headers</p>

Parameter	Description
<i>Convert to JSON</i>	<p>Headers are saved as attribute and value pairs under the "header" key. If 'Content-Type: application/json' is encountered then body is saved as an object, otherwise it is stored as string, for example:</p> <pre>{ "header": { "<key>": "<value>", "<key2>": "<value>" }, "body": <body> }</pre>
<i>HTTP proxy</i>	<p>You can specify an HTTP proxy to use, using the format [protocol://] [username[:password]@]proxy.example.com[:port]. The optional protocol:// prefix may be used to specify alternative proxy protocols (e.g. https, socks4, socks5; see documentation; the protocol prefix support was added in cURL 7.21.7). With no protocol specified, the proxy will be treated as an HTTP proxy. If you specify the wrong protocol, the connection will fail and the item will become unsupported. By default, 1080 port will be used. If specified, the proxy will overwrite proxy related environment variables like http_proxy, HTTPS_PROXY. If not specified, the proxy will not overwrite proxy-related environment variables. The entered value is passed on "as is", no sanity checking takes place. <i>Note</i> that only simple authentication is supported with HTTP proxy. Supported macros: {HOST.IP}, {HOST.CONN}, {HOST.DNS}, {HOST.HOST}, {HOST.NAME}, {HOST.PORT}, {ITEM.ID}, {ITEM.KEY}, {ITEM.KEY.ORIG}, user macros, low-level discovery macros. This sets the CURLOPT_PROXY cURL option.</p>
<i>HTTP authentication</i>	<p>Select the authentication option: None - no authentication used; Basic - basic authentication is used; NTLM - NTLM (Windows NT LAN Manager) authentication is used; Kerberos - Kerberos authentication is used (see also: Configuring Kerberos with Zabbix); Digest - Digest authentication is used. This sets the CURLOPT_HTTPAUTH cURL option.</p>
<i>Username</i>	<p>Enter the user name (up to 255 characters). This field is available if <i>HTTP authentication</i> is set to Basic, NTLM, Kerberos, or Digest. User macros and low-level discovery macros are supported.</p>
<i>Password</i>	<p>Enter the user password (up to 255 characters). This field is available if <i>HTTP authentication</i> is set to Basic, NTLM, Kerberos, or Digest. User macros and low-level discovery macros are supported.</p>
<i>SSL verify peer</i>	<p>Mark the checkbox to verify the SSL certificate of the web server. The server certificate will be automatically taken from system-wide certificate authority (CA) location. You can override the location of CA files using Zabbix server or proxy configuration parameter SSLCAlocation. This sets the CURLOPT_SSL_VERIFYPEER cURL option.</p>
<i>SSL verify host</i>	<p>Mark the checkbox to verify that the Common Name field or the Subject Alternate Name field of the web server certificate matches. This sets the CURLOPT_SSL_VERIFYHOST cURL option.</p>
<i>SSL certificate file</i>	<p>Name of the SSL certificate file used for client authentication. The certificate file must be in PEM¹ format. If the certificate file contains also the private key, leave the SSL key file field empty. If the key is encrypted, specify the password in SSL key password field. The directory containing this file is specified by Zabbix server or proxy configuration parameter SSLCertLocation. Supported macros: {HOST.IP}, {HOST.CONN}, {HOST.DNS}, {HOST.HOST}, {HOST.NAME}, {HOST.PORT}, {ITEM.ID}, {ITEM.KEY}, {ITEM.KEY.ORIG}, user macros, low-level discovery macros. This sets the CURLOPT_SSLCERT cURL option.</p>

Parameter	Description
<i>SSL key file</i>	Name of the SSL private key file used for client authentication. The private key file must be in PEM ¹ format. The directory containing this file is specified by Zabbix server or proxy configuration parameter <code>SSLKeyLocation</code> . Supported macros: {HOST.IP}, {HOST.CONN}, {HOST.DNS}, {HOST.HOST}, {HOST.NAME}, {HOST.PORT}, {ITEM.ID}, {ITEM.KEY}, {ITEM.KEY.ORIG}, user macros, low-level discovery macros. This sets the <code>CURLOPT_SSLKEY</code> cURL option.
<i>SSL key password</i>	SSL private key file password. Supported macros: user macros, low-level discovery macros. This sets the <code>CURLOPT_KEYPASSWD</code> cURL option.
<i>Timeout</i>	Zabbix will not spend more than the set amount of time on processing the URL (1-600 seconds). Actually this parameter defines the maximum time for making a connection to the URL and maximum time for performing an HTTP request. Therefore, Zabbix will not spend more than 2 x <i>Timeout</i> seconds on one check. This sets the <code>CURLOPT_TIMEOUT</code> cURL option. For more information on the <i>Timeout</i> parameter, see general item attributes .
<i>Enable trapping</i>	With this checkbox marked, the item will also function as a trapper item and will accept data sent to Zabbix server or proxy using the Zabbix sender utility or Zabbix sender protocol , or will accept data sent to Zabbix server using the history.push API method. For more information about sending data, see: Trapper items .
<i>Allowed hosts</i>	Visible only if <i>Enable trapping</i> checkbox is marked. List of comma delimited IP addresses, optionally in CIDR notation, or DNS names. If specified, incoming connections will be accepted only from the hosts listed here. If IPv6 support is enabled then '127.0.0.1', '::127.0.0.1', '::ffff:127.0.0.1' are treated equally and '::/0' will allow any IPv4 or IPv6 address. '0.0.0.0/0' can be used to allow any IPv4 address. Note that "IPv4-compatible IPv6 addresses" (0000::/96 prefix) are supported but deprecated by RFC4291 . Example: 127.0.0.1, 192.168.1.0/24, 192.168.3.1-255, 192.168.1-10.1-255, ::1,2001:db8::/32, mysqlserver1, zabbix.example.com, {HOST.HOST} Spaces and user macros are allowed in this field. Host macros: {HOST.HOST}, {HOST.NAME}, {HOST.IP}, {HOST.DNS}, {HOST.CONN} are allowed in this field.

Note:

If the *HTTP proxy* field is left empty, another way for using an HTTP proxy is to set proxy-related environment variables. For HTTP - set the `http_proxy` environment variable for the Zabbix server user. For example:
`http_proxy=http://proxy_ip:proxy_port.`
For HTTPS - set the `HTTPS_PROXY` environment variable. For example:
`HTTPS_PROXY=http://proxy_ip:proxy_port.` More details are available by running a shell command: `# man curl`.

Attention:

[1] Zabbix supports certificate and private key files in PEM format only. In case you have your certificate and private key data in PKCS #12 format file (usually with extension *.p12 or *.pfx) you may generate the PEM file from it using the following commands:
`openssl pkcs12 -in ssl-cert.p12 -clcerts -nokeys -out ssl-cert.pem`
`openssl pkcs12 -in ssl-cert.p12 -nocerts -nodes -out ssl-cert.key`

Examples

Example 1

Send simple GET requests to retrieve data from services such as Elasticsearch:

- Create a GET item with URL: `localhost:9200/?pretty`
- Notice the response:

```
{
  "name" : "YQ2VAY-",
  "cluster_name" : "elasticsearch",
  "cluster_uuid" : "kH4CYqh5QfqgeTsjh2F9zg",
```

```

"version" : {
  "number" : "6.1.3",
  "build_hash" : "af51318",
  "build_date" : "2018-01-26T18:22:55.523Z",
  "build_snapshot" : false,
  "lucene_version" : "7.1.0",
  "minimum_wire_compatibility_version" : "5.6.0",
  "minimum_index_compatibility_version" : "5.0.0"
},
"tagline" : "You know, for search"
}

```

- Now extract the version number using a JSONPath preprocessing step: \$.version.number

Example 2

Send simple POST requests to retrieve data from services such as Elasticsearch:

- Create a POST item with URL: http://localhost:9200/str/values/_search?scroll=10s
- Configure the following POST body to obtain the processor load (1 min average per core)

```

{
  "query": {
    "bool": {
      "must": [{
        "match": {
          "itemid": 28275
        }
      }],
      "filter": [{
        "range": {
          "clock": {
            "gt": 1517565836,
            "lte": 1517566137
          }
        }
      ]
    }
  }
}

```

- Received:

```

{
  "_scroll_id": "DnF1ZXJ5VGh1bkZldGNobQAAAAAAAAAAkF1lRMlZBWS1UU1pxTmdEeGVwQjRBTfEAAAAAAAAAJRZZUTJWQVh",
  "took": 18,
  "timed_out": false,
  "_shards": {
    "total": 5,
    "successful": 5,
    "skipped": 0,
    "failed": 0
  },
  "hits": {
    "total": 1,
    "max_score": 1.0,
    "hits": [{
      "_index": "dbl",
      "_type": "values",
      "_id": "dqX9VWEbV6sEKSMYk6sw",
      "_score": 1.0,
      "_source": {
        "itemid": 28275,
        "value": "0.138750",
        "clock": 1517566136,
        "ns": 25388713,

```

```

    "ttl": 604800
  }
}
]
}
}

```

- Now use a JSONPath preprocessing step to get the item value: `$.hits.hits[0]._source.value`

Example 3

Checking if Zabbix API is alive, using `apiinfo.version`.

- Item configuration:

The screenshot shows the 'Preprocessing' tab of the Zabbix Item configuration page. The configuration is as follows:

- Name:** Check Zabbix API version
- Type:** HTTP agent
- Key:** check_zabbix_api_apiinfo.version
- Type of information:** Numeric (unsigned)
- URL:** http://zabbix-web-apache-mysql/api-jsonrpc.php
- Query fields:** A table with 'Name' and 'Value' columns. One entry is 'name' pointing to 'value'.
- Request type:** POST
- Request body type:** JSON data
- Request body:** A JSON object: `{ "jsonrpc": "2.0", "method": "apiinfo.version", "params": [], "id": 1 }`
- Headers:** A table with 'Name' and 'Value' columns. One entry is 'Content-Type' pointing to 'application/json-rpc'.
- Required status codes:** 200
- Follow redirects:** Checked
- Retrieve mode:** Headers

Note the use of the POST method with JSON data, setting request headers and asking to return headers only:

- Item value preprocessing with regular expression to get HTTP code:

The screenshot shows the 'Preprocessing' tab of the Zabbix Item configuration page. A preprocessing step is configured as follows:

Preprocessing steps	Name	Parameters
1:	Regular expression	HTTPV1.1 ([0-9]+)

- Checking the result in *Latest data*:

Filter

Host groups

Hosts
type here to search

Application

Name

Show items without data

Show details

<input type="checkbox"/>	Host	Name	Last check	Last value	Change
<input type="checkbox"/>	Zabbix server	- other - (1 Item)			
<input type="checkbox"/>		Check Zabbix API version	2018-05-16 23:50:34	OK (200)	Graph

Example 4

Retrieving weather information by connecting to the Openweathermap public service.

- Configure a master item for bulk data collection in a single JSON:

Item
Tags
Preprocessing

* Name

Type

* Key

Type of information

* URL

Query fields

Name	Value	
<input type="text" value="units"/>	<input type="text" value="metric"/>	Remove
<input type="text" value="lat"/>	<input type="text" value="{ \$LAT }"/>	Remove
<input type="text" value="lon"/>	<input type="text" value="{ \$LON }"/>	Remove
<input type="text" value="APPID"/>	<input type="text" value="{ \$WEATHER_APIKEY }"/>	Remove
<input type="text" value="lang"/>	<input type="text" value="{ \$WEATHER_LANG }"/>	Remove

[Add](#)

Request type

Request body type

Note the usage of macros in query fields. Refer to the [Openweathermap API](#) for how to fill them.

Sample JSON returned in response to HTTP agent:

```

{
  "body": {
    "coord": {
      "lon": 40.01,
      "lat": 56.11
    },
    "weather": [{
      "id": 801,
      "main": "Clouds",
      "description": "few clouds",
      "icon": "02n"
    }],
    "base": "stations",
    "main": {
      "temp": 15.14,
      "pressure": 1012.6,
      "humidity": 66,

```

```

    "temp_min": 15.14,
    "temp_max": 15.14,
    "sea_level": 1030.91,
    "grnd_level": 1012.6
  },
  "wind": {
    "speed": 1.86,
    "deg": 246.001
  },
  "clouds": {
    "all": 20
  },
  "dt": 1526509427,
  "sys": {
    "message": 0.0035,
    "country": "RU",
    "sunrise": 1526432608,
    "sunset": 1526491828
  },
  "id": 487837,
  "name": "Stavrovo",
  "cod": 200
}
}

```

The next task is to configure dependent items that extract data from the JSON.

- Configure a sample dependent item for humidity:

Item	Tags	Preprocessing
		<p>* Name <input type="text" value="Humidity"/></p> <p>Type <input type="text" value="Dependent item"/></p> <p>* Key <input type="text" value="humidity"/></p> <p>Type of information <input type="text" value="Numeric (float)"/></p> <p>* Master item <input type="text" value="Apache: Get weather"/></p> <p>Units <input type="text"/></p>

Other weather metrics such as 'Temperature' are added in the same manner.

- Sample dependent item value preprocessing with JSONPath:

Item	Tags	Preprocessing 1						
		<table border="1"> <thead> <tr> <th>Preprocessing steps</th> <th>Name</th> <th>Parameters</th> </tr> </thead> <tbody> <tr> <td>1:</td> <td>JSONPath</td> <td>\$.body.main.humidity</td> </tr> </tbody> </table> <p>Add</p>	Preprocessing steps	Name	Parameters	1:	JSONPath	\$.body.main.humidity
Preprocessing steps	Name	Parameters						
1:	JSONPath	\$.body.main.humidity						

- Check the result of weather data in *Latest data*:

<input type="checkbox"/>	Host	Name ▲	Inter...	History	Trends	Type	Last check	Last value
▼	<u>weather</u>	Weather (8 Items)						
<input type="checkbox"/>		Get weather get_weather.http	10m	1d		HTTP agent	2018-05-17 01:23:45	{'body': {'coord': {'lon...
<input type="checkbox"/>		Get weather HTTP response code get_weather.http_code		7d	0	Depende...	2018-05-17 01:23:45	OK (200)
<input type="checkbox"/>		Humidity humidity		90d	365d	Depende...	2018-05-17 01:23:45	66 %
<input type="checkbox"/>		Temperature temp		90d	365d	Depende...	2018-05-17 01:23:45	15.14 C
<input type="checkbox"/>		Weather weather		90d		Depende...	2018-05-17 01:23:45	Clouds
<input type="checkbox"/>		Weather condition id weather.condition.id		7d	0	Depende...	2018-05-17 01:23:45	801
<input type="checkbox"/>		Weather description weather.description		90d		Depende...	2018-05-17 01:23:45	few clouds
<input type="checkbox"/>		Wind speed wind.speed		90d	365d	Depende...	2018-05-17 01:23:45	1.86 m/s

Example 5

Connecting to Nginx status page and getting its metrics in bulk.

- Configure Nginx following the [official guide](#).
- Configure a master item for bulk data collection:

Item [Tags](#) [Preprocessing](#)

* Name

Type

* Key

Type of information

* URL

Query fields

Name	⇒	Value
<input type="text" value="name"/>	⇒	<input type="text" value="value"/>

[Remove](#)

[Add](#)

Request type

Request body type Raw data JSON data XML data

Sample Nginx stub status output:

```
Active connections: 1 Active connections:
server accepts handled requests
 52 52 52
Reading: 0 Writing: 1 Waiting: 0
```

The next task is to configure dependent items that extract data.

- Configure a sample dependent item for requests per second:

Item Tags 1 Preprocessing 2

* Name Client requests per second

Type Dependent item

* Key nginx_requests_rps

Type of information Numeric (unsigned)

* Master item Nginx by HTTP: Nginx: Get stub status page

- Sample dependent item value preprocessing with regular expression `server accepts handled requests\s+([0-9]+) ([0-9]+) ([0-9]+)`:

Item Tags Preprocessing 2

Preprocessing steps	Name	Parameters
1:	Regular expression	requests\s+([0-9]+) ([0-9]+) ([0-9]+) \3
2:	Change per second	

Add

- Check the complete result from stub module in *Latest data*:

Host	Name	Last check	Last value
nginx	Nginx (8 Items)		
	Accepted client connections	2018-05-18 17:54:53	568
	Active connections	2018-05-18 17:54:53	1
	Client requests per second	2018-05-18 17:54:53	0 rps
	Get Nginx stub status	2018-05-18 17:54:53	HTTP/1.1 200 OK Se...
	Handled connections per second	2018-05-18 17:54:53	0
	Reading	2018-05-18 17:54:53	0
	Waiting	2018-05-18 17:54:53	0
	Writing	2018-05-18 17:54:53	1

17 Prometheus checks

Overview

Zabbix can query metrics exposed in the Prometheus line format.

Two steps are required to start gathering Prometheus data:

- an **HTTP master item** pointing to the appropriate data endpoint, e.g. `https://<prometheus host>/metrics`
- dependent items using a Prometheus preprocessing option to query required data from the metrics gathered by the master item

There are two Prometheus data preprocessing options:

- Prometheus pattern* - used in normal items to query Prometheus data
- Prometheus to JSON* - used in normal items and for low-level discovery. In this case queried Prometheus data are returned in a JSON format.

Bulk processing

Bulk processing is supported for dependent items. To enable caching and indexing, the *Prometheus pattern* preprocessing must be the **first** preprocessing step. When *Prometheus pattern* is first preprocessing step then the parsed Prometheus data is cached and indexed by the first `<label>==<value>` condition in the *Prometheus pattern* preprocessing step. This cache is reused when

processing other dependent items in this batch. For optimal performance, the first label should be the one with most different values.

If there is other preprocessing to be done before the first step, it should be moved either to the master item or to a new dependent item which would be used as the master item for the dependent items.

Configuration

Providing you have the HTTP master item configured, you need to create a **dependent item** that uses a Prometheus preprocessing step:

- Enter general dependent item parameters in the configuration form
- Go to the Preprocessing tab
- Select a Prometheus preprocessing option (*Prometheus pattern* or *Prometheus to JSON*)

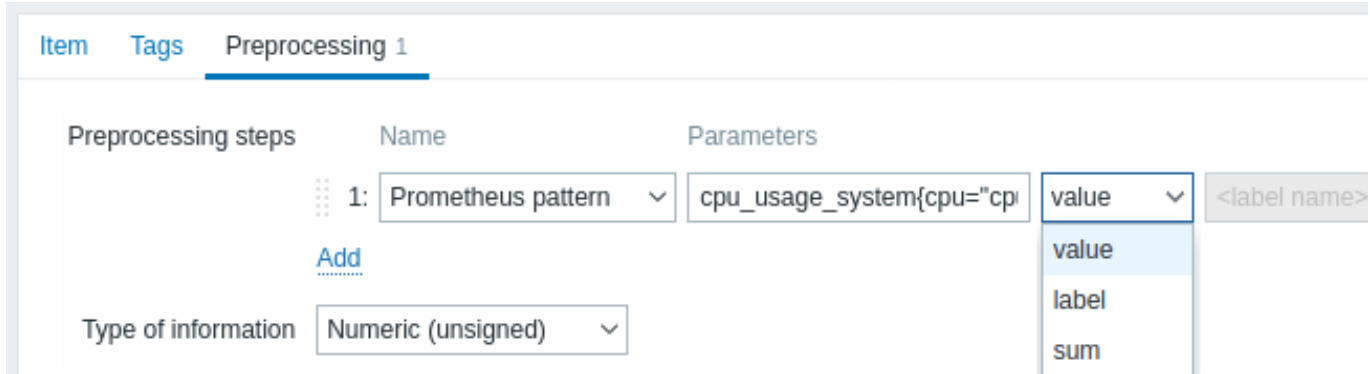

The following parameters are specific to the *Prometheus pattern* preprocessing option:

Parameter	Description	Examples
<i>Pattern</i>	<p>To define the required data pattern you may use a query language that is similar to Prometheus query language (see comparison table), e.g.:</p> <p><metric name> - select by metric name</p> <p>{_name_="<metric name>"} - select by metric name</p> <p>{_name_=~"<regex>"} - select by metric name matching a regular expression</p> <p>{<label name>="<label value>","..."} - select by label name</p> <p>{<label name>=~"<regex>","..."} - select by label name matching a regular expression</p> <p>{_name_=~".*"}==<value> - select by metric value</p> <p>Or a combination of the above:</p> <p><metric name>{<label1 name>="<label1 value>",<label2 name>=~"<regex>","..."}==<value></p> <p>Label value can be any sequence of UTF-8 characters, but the backslash, double-quote and line feed characters have to be escaped as \\, \" and \n respectively; other characters shall not be escaped.</p>	<pre>wmi_os_physical_memory_free_bytes cpu_usage_system{cpu="cpu-total"} cpu_usage_system{cpu=~".*"} cpu_usage_system{cpu="cpu-total",host=~".*"} wmi_service_state{name="dhcp"}==1 wmi_os_timezone{timezone=~".*"}==1</pre>

Parameter	Description	Examples
<i>Result processing</i>	Specify whether to return the value, the label or apply the appropriate function (if the pattern matches several lines and the result needs to be aggregated): value - return metric value (error if multiple lines matched) label - return value of the label specified in the <i>Label</i> field (error if multiple metrics are matched) sum - return the sum of values min - return the minimum value max - return the maximum value avg - return the average value count - return the count of values This field is only available for the <i>Prometheus pattern</i> option.	See also examples of using parameters below.
<i>Output</i>	Define label name (optional). In this case the value corresponding to the label name is returned. This field is only available for the <i>Prometheus pattern</i> option, if 'Label' is selected in the <i>Result processing</i> field.	

Examples of using parameters

1. The most common use case is to return the **value**. To return the value of `/var/db` from:

```
node_disk_usage_bytes{path="/var/cache"} 2.1766144e+09  
node_disk_usage_bytes{path="/var/db"} 20480  
node_disk_usage_bytes{path="/var/dpkg"} 8192  
node_disk_usage_bytes{path="/var/empty"} 4096
```

use the following parameters:

- *Pattern* - `node_disk_usage_bytes{path="/var/db"}`
- *Result processing* - `select 'value'`

2. You may also be interested in the **average** value of all `node_disk_usage_bytes` parameters:

- *Pattern* - `node_disk_usage_bytes`
- *Result processing* - `select 'avg'`

3. While Prometheus supports only numerical data, it is popular to use a workaround that allows to return the relevant textual description as well. This can be accomplished with a filter and specifying the label. So, to return the value of the 'color' label from

```
elasticsearch_cluster_health_status{cluster="elasticsearch",color="green"} 1  
elasticsearch_cluster_health_status{cluster="elasticsearch",color="yellow"} 0
```

use the following parameters:

- *Pattern* - `elasticsearch_cluster_health_status {cluster="elasticsearch"} == 1`
- *Result processing* - `select 'label'`
- *Label* - specify 'color'

The filter (based on the numeric value '1') will match the appropriate row, while the label will return the health status description (currently 'green'; but potentially also 'red' or 'yellow').

Prometheus to JSON

Data from Prometheus can be used for low-level discovery. In this case data in JSON format are needed and the *Prometheus to JSON* preprocessing option will return exactly that.

For more details, see [Discovery using Prometheus data](#).

Query language comparison

The following table lists differences and similarities between PromQL and Zabbix Prometheus preprocessing query language.

PromQL instant vector selector	Zabbix Prometheus preprocessing
Differences	

PromQL instant vector selector		Zabbix Prometheus preprocessing
Query target	Prometheus server	Plain text in Prometheus exposition format
Returns	Instant vector	Metric or label value (Prometheus pattern) Array of metrics for single value in JSON (Prometheus to JSON)
Label matching operators	=, !=, =~, !~	=, !=, =~, !~
Regular expression used in label or metric name matching	RE2	PCRE
Comparison operators	See list	Only == (equal) is supported for value filtering
Similarities		
Selecting by metric name that equals string	<metric name> or {__name__="<metric name>"}	<metric name> or {__name__="<metric name>"}
Selecting by metric name that matches regular expression	{__name__=~"<regex>"}	{__name__=~"<regex>"}
Selecting by <label name> value that equals string	{<label name>="<label value>","...}	{<label name>="<label value>","...}
Selecting by <label name> value that matches regular expression	{<label name>=~"<regex>","...}	{<label name>=~"<regex>","...}
Selecting by value that equals string	{__name__=~".*" } == <value>	{__name__=~".*" } == <value>

18 Script items

Overview

Script items can be used to collect data by executing a user-defined JavaScript code with the ability to retrieve data over HTTP/HTTPS. In addition to the script, an optional list of parameters (pairs of name and value) and timeout can be specified.

This item type may be useful in data collection scenarios that require multiple steps or complex logic. As an example, a Script item can be configured to make an HTTP call, then process the data received in the first step in some way, and pass transformed value to the second HTTP call.

Script items are processed by Zabbix server or proxy pollers.

Configuration

In the *Type* field of [item configuration form](#) select Script then fill out required fields.

Item Tags Preprocessing

* Name

Type

* Key

Type of information

Name	Value	Action
<input type="text" value="host"/>	<input type="text" value="{HOST.CONN}"/>	Remove
<input type="text" value="endpoint"/>	<input type="text" value="{SENDPOINT}"/>	Remove
Add		

* Script

* Update interval

Type	Interval	Period	Action
<input type="text" value="Flexible"/> <input type="text" value="Scheduling"/>	<input type="text" value="50s"/>	<input type="text" value="1-7,00:00-24:00"/>	Remove
Add			

* Timeout [Timeouts](#)

* History

Populates host inventory field

Description

Enabled

All mandatory input fields are marked with a red asterisk.

The fields that require specific information for Script items are:

Field	Description
<i>Key</i>	Enter a unique key that will be used to identify the item.
<i>Parameters</i>	Specify the variables to be passed to the script as the attribute and value pairs. User macros are supported. To see which built-in macros are supported, do a search for "Script-type item" in the supported macro table.
<i>Script</i>	Enter JavaScript code in the modal editor that opens when clicking in the parameter field or on the pencil icon next to it. This code must provide the logic for returning the metric value. The code has access to all parameters and all additional JavaScript objects added by Zabbix. See also: JavaScript Guide .
<i>Timeout</i>	JavaScript execution timeout (1-600s; exceeding it will return an error). Note that depending on the script, it might take longer for the timeout to trigger. For more information on the <i>Timeout</i> parameter, see general item attributes .

Examples

Simple data collection

Collect the content of `https://www.example.com/release_notes`:

- Create an item with type "Script".
- In the *Script* field, enter:

```
var request = new HttpRequest();
return request.get("https://www.example.com/release_notes");
```

Data collection with parameters

Collect the content of a specific page and make use of parameters:

- Create an item with type "Script" and two parameters:
 - **url** : **{ \$DOMAIN }** (the user macro { \$DOMAIN } should be defined, preferably on the host level)
 - **subpage** : **/release_notes**

Item Tags Preprocessing

* Name

Type

* Key

Type of information

Name	Value	Action
<input type="text" value="url"/>	<input type="text" value="{ \$DOMAIN }"/>	Remove
<input type="text" value="subpage"/>	<input type="text" value="/release_notes"/>	Remove

[Add](#)

* Script

- In the *Script* field, enter:

```
var obj = JSON.parse(value);
var url = obj.url;
var subpage = obj.subpage;
var request = new HttpRequest();
return request.get(url + subpage);
```

Multiple HTTP requests

Collect the content of both `https://www.example.com` and `https://www.example.com/release_notes`:

- Create an item with type "Script".
- In the *Script* field, enter:

```
var request = new HttpRequest();
return request.get("https://www.example.com") + request.get("https://www.example.com/release_notes");
```

Logging

Add the "Log test" entry to the Zabbix server log and receive the item value "1" in return:

- Create an item with type "Script".
- In the *Script* field, enter:

```
Zabbix.log(3, 'Log test');
return 1;
```

19 Browser items

Overview

Browser items allow monitoring complex websites and web applications using a browser.

Attention:

The support of Browser items is currently experimental.

Browser items collect data by executing a user-defined JavaScript code and retrieving data over HTTP/HTTPS. This item can simulate such browser-related actions as clicking, entering text, navigating through web pages, and other user interactions with websites or web applications.

In addition to the script, an optional list of parameters (pairs of name and value) and timeout can be specified.

Attention:

The item partially implements the [W3C WebDriver standard](#) with either Selenium Server or a plain WebDriver (for example, ChromeDriver) as a web testing endpoint. For the item to work, set the endpoint in the Zabbix [server/proxy](#) configuration file `WebDriverURL` parameter (if using ChromeDriver, see [Security Considerations](#)). For better performance, consider using a dedicated server for the web testing environment.

Browser items are executed and processed by Zabbix server or proxy browser pollers. If necessary, you can adjust the number of pre-forked instances of Browser item pollers in the Zabbix [server/proxy](#) configuration file `StartBrowserPollers` parameter.

For monitoring complex websites and web applications, the [Website by Browser](#) template is available as an **out-of-the-box template**.

Configuration

In the `Type` field of [item configuration form](#), select Browser and then fill out the required fields.

New item [?] [X]

Item | Tags | Preprocessing

* Name

Type

* Key

Type of information

Name	Value	Action
<input type="text"/>	<input type="text"/>	<input type="button" value="Remove"/>

* Script

Units

* Update interval

Type	Interval	Period	Action
<input type="button" value="Flexible"/> <input type="button" value="Scheduling"/>	<input type="text" value="50s"/>	<input type="text" value="1-7,00:00-24:00"/>	<input type="button" value="Remove"/>

* Timeout

* History

* Trends

Value mapping

Populates host inventory field

Description

Enabled

All mandatory input fields are marked with a red asterisk.

The fields that require specific information for Browser items are:

Field	Description
Key	Enter a unique key that will be used to identify the item.

Field	Description
<i>Parameters</i>	Specify the variables to be passed to the script as the attribute and value pairs. User macros are supported. To see which built-in macros are supported, do a search for "Browser-type item" in the supported macro table.
<i>Script</i>	Enter JavaScript code in the modal editor that opens when clicking in the parameter field or on the pencil icon next to it. This code must provide the logic for returning the metric value. The code has access to all parameters, all additional JavaScript objects and Browser item JavaScript objects added by Zabbix. See also: JavaScript Guide .
<i>Timeout</i>	JavaScript execution timeout (1-600s; exceeding it will return an error). Note that depending on the script, it might take longer for the timeout to trigger. For more information on the <i>Timeout</i> parameter, see general item attributes .

Examples

For an example of how to set up Zabbix for monitoring websites using the *Website by Browser* template, see [Monitor websites with Browser items](#).

Default script

The following script:

1. Initializes a browser session.
2. Navigates to a specified URL.
3. Collects performance entries and session statistics, and returns them as a JSON string.

In the *Script* field, enter:

```
var browser = new Browser(Browser.chromeOptions());

try {
    browser.navigate("http://example.com");
    browser.collectPerfEntries();
}
finally {
    return JSON.stringify(browser.getResult());
}
```

Initialize browser with custom capabilities

The following script:

1. Initializes a browser session for the available browser based on the first matching browser in the order specified within the script.
2. Defines browser capabilities, including page load strategy and options specific to each browser, such as the headless mode for Chrome, Firefox, and Microsoft Edge browsers.

In the *Script* field, enter:

```
var browser = new Browser({
    "capabilities":{
        "firstMatch":[
            {
                "browserName":"chrome",
                "pageLoadStrategy":"normal",
                "goog:chromeOptions":{
                    "args":[
                        "--headless=new"
                    ]
                }
            },
            {
                "browserName":"firefox",
                "pageLoadStrategy":"normal",
                "moz:firefoxOptions":{
                    "args":[
                        "--headless"
                    ]
                }
            }
        ]
    }
});
```

```

    ]
  },
  {
    "browserName": "MicrosoftEdge",
    "pageLoadStrategy": "normal",
    "ms:edgeOptions": {
      "args": [
        "--headless=new"
      ]
    }
  },
  {
    "browserName": "safari",
    "pageLoadStrategy": "normal"
  }
]
});

```

Initialize browser with GUI

By default, browser sessions (excluding Safari) are initialized in headless mode, meaning the browser's graphical user interface (GUI) is not displayed.

The following script initializes a browser session with the GUI enabled.

Note that if the WebDriver cannot locate the browser binary, you can specify the path manually.

```

var opts = Browser.chromeOptions();
opts.capabilities.alwaysMatch['goog:chromeOptions'].args = [];

// To initialize a Firefox session with GUI, uncomment the following lines:
// var opts = Browser.firefoxOptions();
// opts.capabilities.alwaysMatch['moz:firefoxOptions'].binary = 'usr/bin/firefox';
// opts.capabilities.alwaysMatch['moz:firefoxOptions'].args = [];

// To initialize a Microsoft Edge session with GUI, uncomment the following lines:
// var opts = Browser.edgeOptions();
// opts.capabilities.alwaysMatch['ms:edgeOptions'].binary = 'usr/bin/microsoft-edge';
// opts.capabilities.alwaysMatch['ms:edgeOptions'].args = [];

var browser = new Browser(opts);

```

Note:

If your tests are running on a remote server or in a container, you can use a Virtual Network Computing (VNC) client to connect to the machine's VNC server. This lets you view and interact with the browser's GUI remotely.

Take screenshots

The following script:

1. Initializes a browser session.
2. Sets the browser's viewport size to determine the screenshot size (specified as parameters, see below).
3. Navigates to a URL (specified as a parameter, see below).
4. Collects session statistics, captures a screenshot, and adds it to the collected statistics.
5. Handles errors by capturing error messages and a screenshot.
6. Returns the collected results as a JSON string.

The script also uses parameters from the [item configuration form](#):

- webURL - http://example.com
- width - 1920
- height - 1080

In the *Script* field, enter:

```

var browser, result;

var browser = new Browser(Browser.chromeOptions());

try {
    var params = JSON.parse(value); // Parse the JSON string containing parameters passed from Zabbix.

    browser.setScreenSize(Number(params.width), Number(params.height))

    browser.navigate(params.webURL);

    result = browser.getResult();
    result.screenshot = browser.getScreenshot();
}
catch (err) {
    if (!(err instanceof BrowserError)) {
        browser.setError(err.message);
    }
    result = browser.getResult();
    result.error.screenshot = browser.getScreenshot();
}
finally {
    return JSON.stringify(result);
}

```

Check Zabbix login

The following script:

1. Initializes a browser session.
2. Navigates to a page (specified as a parameter, see below).
3. Enters the username and password (specified as parameters, see below).
4. Finds and clicks the login button.
5. Finds and clicks the logout button.
6. Collects performance data before and after login, as well as after logout.
7. Handles errors by capturing error messages and a screenshot.
8. Returns the collected results as a JSON string.

The script also uses parameters from the **item configuration form**:

- webURL - http://{HOST.CONN}/index.php
- username - {\$USERNAME}
- password - {\$PASSWORD}

In the *Script* field, enter:

```

var browser, result;

browser = new Browser(Browser.chromeOptions());

try {
    var params = JSON.parse(value); // Parse the JSON string containing parameters passed from Zabbix.

    browser.navigate(params.webURL);
    browser.collectPerfEntries("open page");

    var el = browser.findElement("xpath", "//*[@id='name']");
    if (el === null) {
        throw Error("cannot find name input field");
    }
    el.sendKeys(params.username);

    el = browser.findElement("xpath", "//*[@id='password']");
    if (el === null) {
        throw Error("cannot find password input field");
    }
}

```



```

el.sendKeys(params.password);

el = browser.findElement("xpath", "//button[@id='enter']");
if (el === null) {
    throw Error("cannot find login button");
}
el.click();

browser.collectPerfEntries("login");

el = browser.findElement("link text", "Sign out");
if (el === null) {
    throw Error("cannot find logout button");
}
el.click();

browser.collectPerfEntries("logout");

result = browser.getResult();
}
catch (err) {
    if (!(err instanceof BrowserError)) {
        browser.setError(err.message);
    }
    result = browser.getResult();
    result.error.screenshot = browser.getScreenshot();
}
finally {
    return JSON.stringify(result);
}
}

```

Find links

The following script:

1. Initializes a browser session.
2. Defines a function for removing duplicate elements from an array (see step 5).
3. Navigates to a page (specified as parameters, see below).
4. Finds links on the page.
5. Removes duplicate links to ensure they are unique.
6. Extracts only the links that start with "http".
7. Formats the extracted links to a specific structure.
8. Handles errors by capturing error messages and a screenshot.
9. Returns the collected results as a JSON string.

The script also uses parameters from the **item configuration form**:

- scheme - {\$WEBSITE.SCHEME}
- domain - {\$WEBSITE.DOMAIN}
- path - {\$WEBSITE.PATH}

In the *Script* field, enter:

```

var browser, result;

browser = new Browser(Browser.chromeOptions());

try {
    var params = JSON.parse(value); // Parse the JSON string containing parameters passed from Zabbix.

    function uniq(a) {
        return a.sort().filter(function (item, pos, ary) {
            return !pos || item !== ary[pos - 1];
        });
    }
}

```

```

browser.navigate(params.scheme + '://' + params.domain + params.path);

var el = browser.findElements("link text", "");
var links = [];
for (var n = 0; n < el.length; n++) {
    links.push(el[n].getAttribute('href'));
}

links = uniq(links);

result = [];
for (i = 0; i < links.length; i++) {
    if (links[i].match(/^http.*/)) {
        var row = {};
        row["#URL"] = links[i];
        result.push(row);
    }
}
}
catch (err) {
    if (!(err instanceof BrowserError)) {
        browser.setError(err.message);
    }
    result = browser.getResult();
    result.error.screenshot = browser.getScreenshot();
}
finally {
    return JSON.stringify(result);
}
}

```

4 History and trends

Overview

History and trends are the two ways of storing collected data in Zabbix.

Whereas history keeps each collected value, trends keep averaged information on hourly basis and therefore are less resource-hungry.

Keeping history

You can set for how many days history will be kept:

- in the item properties **form**
- when mass-updating items
- when **setting up** housekeeper tasks

Any older data will be removed by the housekeeper.

The general strong advice is to keep history for the smallest possible number of days and that way not to overload the database with lots of historical values.

Instead of keeping a long history, you can keep longer data of trends. For example, you could keep history for 14 days and trends for 5 years.

You can get a good idea of how much space is required by history versus trends data by referring to the [database sizing page](#).

While keeping shorter history, you will still be able to review older data in graphs, as graphs will use trend values for displaying older data.

Attention:

If history is set to '0', the item will update only dependent items and inventory. No trigger functions will be evaluated because trigger evaluation is based on history data only.

Note:

As an alternative way to preserve history consider to use **history export** functionality of loadable modules.

Keeping trends

Trends is a built-in historical data reduction mechanism which stores minimum, maximum, average and the total number of values per every hour for numeric data types.

You can set for how many days trends will be kept:

- in the item properties **form**
- when mass-updating items
- when setting up Housekeeper tasks

Trends usually can be kept for much longer than history. Any older data will be removed by the housekeeper.

Zabbix server accumulates trend data in runtime in the trend cache, as the data flows in. Server flushes **previous hour** trends of every item into the database (where frontend can find them) in these situations:

- server receives the first current hour value of the item
- 5 or less minutes of the current hour left and still no current hour values of the item
- server stops

To see trends on a graph you need to wait at least to the beginning of the next hour (if item is updated frequently) and at most to the end of the next hour (if item is updated rarely), which is 2 hours maximum.

When server flushes trend cache and there are already trends in the database for this hour (for example, server has been restarted mid-hour), server needs to use update statements instead of simple inserts. Therefore on a bigger installation if restart is needed it is desirable to stop server in the end of one hour and start in the beginning of the next hour to avoid trend data overlap.

History tables do not participate in trend generation in any way.

Attention:

If trends are set to '0', Zabbix server does not calculate or store trends at all.

Note:

The trends are calculated and stored with the same data type as the original values. As a result the average value calculations of unsigned data type values are rounded and the less the value interval is the less precise the result will be. For example if item has values 0 and 1, the average value will be 0, not 0.5. Also restarting server might result in the precision loss of unsigned data type average value calculations for the current hour.

5 User parameters

Overview

Sometimes you may want to run an agent check that does not come predefined with Zabbix. This is where user parameters come to help.

You may write a command that retrieves the data you need and include it in the user parameter in the **agent configuration file** ('UserParameter' configuration parameter).

A user parameter has the following syntax:

```
UserParameter=<key>,<command>
```

As you can see, a user parameter also contains a key. The key will be necessary when configuring an item. Enter a key of your choice that will be easy to reference (it must be unique within a host).

Restart the agent or use the agent **runtime control** option to pick up the new parameter, e. g.:

```
zabbix_agentd -R userparameter_reload
```

Then, when **configuring an item**, enter the key to reference the command from the user parameter you want executed.

User parameters are commands executed by Zabbix agent. Note that up to 16MB of data can be returned before **item value preprocessing** steps.

/bin/sh is used as a command line interpreter under UNIX operating systems. User parameters obey the agent check timeout; if timeout is reached the forked user parameter process is terminated.

See also:

- [Step-by-step tutorial](#) on making use of user parameters
- [Command execution](#)

Examples of simple user parameters

A simple command:

```
UserParameter=ping,echo 1
```

The agent will always return '1' for an item with 'ping' key.

A more complex example:

```
UserParameter=mysql.ping,mysqladmin -uroot ping | grep -c alive
```

The agent will return '1', if MySQL server is alive, '0' - otherwise.

Flexible user parameters

Flexible user parameters accept parameters with the key. This way a flexible user parameter can be the basis for creating several items.

Flexible user parameters have the following syntax:

```
UserParameter=key[*],command
```

Parameter	Description
Key	Unique item key. The [*] defines that this key accepts parameters within the brackets. Parameters are given when configuring the item.
Command	Command to be executed to evaluate value of the key. <i>For flexible user parameters only:</i> You may use positional references \$1...\$9 in the command to refer to the respective parameter in the item key. Zabbix parses the parameters enclosed in [] of the item key and substitutes \$1,...,\$9 in the command accordingly. \$0 will be substituted by the original command (prior to expansion of \$0,...,\$9) to be run. Positional references are interpreted regardless of whether they are enclosed between double (") or single (') quotes. To use positional references unaltered, specify a double dollar sign - for example, awk '{print \$\$2}'. In this case \$\$2 will actually turn into \$2 when executing the command.

Attention:

Positional references with the \$ sign are searched for and replaced by Zabbix agent only for flexible user parameters. For simple user parameters, such reference processing is skipped and, therefore, any \$ sign quoting is not necessary.

Attention:

Certain symbols are not allowed in user parameters by default. See [UnsafeUserParameters](#) documentation for a full list.

Example 1

Something very simple:

```
UserParameter=ping[*],echo $1
```

We may define unlimited number of items for monitoring all having format ping[something].

- ping[0] - will always return '0'
- ping[aaa] - will always return 'aaa'

Example 2

Let's add more sense!

```
UserParameter=mysql.ping[*],mysqladmin -u$1 -p$2 ping | grep -c alive
```

This parameter can be used for monitoring availability of MySQL database. We can pass user name and password:

```
mysql.ping[zabbix,our_password]
```

Example 3

How many lines matching a regular expression in a file?

```
UserParameter=wc[*],grep -c "$2" $1
```

This parameter can be used to calculate number of lines in a file.

```
wc[/etc/passwd,root]  
wc[/etc/services,zabbix]
```

Command result

The return value of the command is a standard output together with a standard error produced by the command.

Attention:

An item that returns text (character, log, or text type of information) will not become unsupported in case of a standard error output.

The return value is limited to 16MB (including trailing whitespace that is truncated); **database limits** also apply.

User parameters that return text (character, log, or text type of information) can also return a whitespace. In case of an invalid result, the item will become unsupported.

1 Extending Zabbix agents

This tutorial provides step-by-step instructions on how to extend the functionality of Zabbix agent with the use of a **user parameter**.

Step 1

Write a script or command line to retrieve required parameter.

For example, we may write the following command in order to get total number of queries executed by a MySQL server:

```
mysqladmin -uroot status | cut -f4 -d":" | cut -f1 -d"S"
```

When executed, the command returns total number of SQL queries.

Step 2

Add the command to `zabbix_agentd.conf`:

```
UserParameter=mysql.questions,mysqladmin -uroot status | cut -f4 -d":" | cut -f1 -d"S"
```

mysql.questions is a unique identifier. It can be any valid key identifier, for example, *queries*.

Test this parameter by using Zabbix agent with `-t` flag (if running under root, however, note that the agent may have different permissions when launched as a daemon):

```
zabbix_agentd -t mysql.questions
```

Step 3

Reload user parameters from the configuration file by running:

```
zabbix_agentd -R userparameter_reload
```

You may also restart the agent instead of the runtime control command.

Test the parameter by using **zabbix_get** utility.

Step 4

Add new item with `Key=mysql.questions` to the monitored host. Type of the item must be either Zabbix Agent or Zabbix Agent (active).

Be aware that type of returned values must be set correctly on Zabbix server. Otherwise Zabbix won't accept them.

6 Windows performance counters

Overview

You can effectively monitor Windows performance counters using the `perf_counter[]` key.

For example:

```
perf_counter["\Processor(0)\Interrupts/sec"]
```

or

```
perf_counter["\Processor(0)\Interrupts/sec", 10]
```

For more information on using this key or its English-only equivalent `perf_counter_en`, see [Windows-specific item keys](#).

In order to get a full list of performance counters available for monitoring, you may run:

```
typeperf -qx
```

You may also use low-level discovery to discover multiple [object instances](#) of Windows performance counters and automate the creation of `perf_counter` items for multiple instance objects.

Numeric representation

Windows maintains numeric representations (indexes) for object and performance counter names. Zabbix supports these numeric representations as parameters to the `perf_counter`, `perf_counter_en` item keys and in `PerfCounter`, `PerfCounterEn` configuration parameters.

However, it's not recommended to use them unless you can guarantee your numeric indexes map to correct strings on specific hosts. If you need to create portable items that work across different hosts with various localized Windows versions, you can use the `perf_counter_en` key or `PerfCounterEn` configuration parameter which allow to use English names regardless of system locale.

To find out the numeric equivalents, run **regedit**, then find `HKEY_LOCAL_MACHINE\SOFTWARE\Microsoft\Windows NT\CurrentVersion\Perflib\00`

The registry entry contains information like this:

```
1
1847
2
System
4
Memory
6
% Processor Time
10
File Read Operations/sec
12
File Write Operations/sec
14
File Control Operations/sec
16
File Read Bytes/sec
18
File Write Bytes/sec
....
```

Here you can find the corresponding numbers for each string part of the performance counter, like in `'\System\% Processor Time'`:

```
System → 2
% Processor Time → 6
```

Then you can use these numbers to represent the path in numbers:

```
\2\6
```

Performance counter parameters

You can deploy some `PerfCounter` parameters for the monitoring of Windows performance counters.

For example, you can add these to the Zabbix agent configuration file:

```
PerfCounter=UserPerfCounter1,"\Memory\Page Reads/sec",30
or
PerfCounter=UserPerfCounter2,"\4\24",30
```

With such parameters in place, you can then simply use `UserPerfCounter1` or `UserPerfCounter2` as the keys for creating the respective items.

Remember to restart Zabbix agent after making changes to the configuration file.

7 Mass update

Overview

Sometimes you may want to change some attribute for a number of items at once. Instead of opening each individual item for editing, you may use the mass update function for that.

Using mass update

To mass-update some items, do the following:

- Mark the checkboxes of the items to update in the list
- Click on *Mass update* below the list
- Navigate to the tab with required attributes (*Item*, *Tags* or *Preprocessing*)
- Mark the checkboxes of the attributes to update
- Enter new values for the attributes

Mass update

Item **Tags** **Preprocessing**

Type of information Original

Units Original

Authentication method Original

User name Original

Public key file Original

Private key file Original

Password Original

Update interval Original

Timeout Original

History

Trends Original

Status Original

Log time format Original

Value mapping Original

Enable trapping Original

Allowed hosts Original

Master item Original

Mass update

Item **Tags** Preprocessing

Tags **Add** Replace Remove

Name

Value

tag

value

[Add](#)

The *Tags* option allows to:

- *Add* - add specified tags to the items (tags with the same name, but different values are not considered 'duplicates' and can be added to the same item).
- *Replace* - remove the specified tags and add tags with new values
- *Remove* - remove specified tags from the items

User macros, {INVENTORY.*} macros, {HOST.HOST}, {HOST.NAME}, {HOST.CONN}, {HOST.DNS}, {HOST.IP}, {HOST.PORT} and {HOST.ID} macros are supported in tags.

Mass update

Item **Tags** **Preprocessing**

Preprocessing steps **Replace** Remove all

Name

Parameters

⋮

1:

Regular expression

▼

pattern

output

[Add](#)

Mark the checkbox next to *Preprocessing steps* to activate mass update for preprocessing steps.

The *Preprocessing* mass update allows to:

- *Replace* - replace the existing preprocessing steps on the items with the preprocessing steps specified below
- *Remove all* - remove all preprocessing steps from the items

When done, click on *Update*.

8 Value mapping

Overview

Value mapping allows configuring a more user-friendly representation of received values using mappings between numeric/string values and string representations.

For example, when an item's value is "0" or "1," value mappings can be used to represent these values in a more user-friendly manner:

- 0 → Not Available
- 1 → Available

Value mappings for data backup types could be configured as follows:

- F → Full
- D → Differential
- I → Incremental

Value ranges for voltage could be configured as follows:

- <=209 → Low
- 210-230 → OK
- >=231 → High

Value mapping is used in Zabbix frontend and notifications sent by media types.

Attention:

Substitution of the received value with the configured representation is performed both in Zabbix frontend and server; however, the server handles substitution only in the following cases:

- when populating **host inventory**;
- when expanding **supported macros** {ITEM.VALUE}, {ITEM.LASTVALUE}, {EVENT.OPDATA}, and {EVENT.CAUSE.OPDATA}.

Value mappings are set up on templates or hosts. Once configured, they are available for all items within the respective template or host. When **configuring items**, specify the name of a previously configured value mapping in the *Value mapping* parameter.

Note:

There is no value map inheritance - hosts and templates do not inherit value mappings from linked templates. Template items on a host will continue to use the value mappings configured on the template.

Note:

Value mappings can be used with items having *Numeric (unsigned)*, *Numeric (float)*, and *Character* types of information.

Value mappings are exported/imported with the respective template or host. They can also be mass-updated using the **host** and **template** mass update forms.

Configuration

To configure a value mapping, follow these steps:

1. Open the host or template configuration form.
2. In the *Value mapping* tab, click *Add* to add a new value mapping, or click on the name of an existing mapping to edit it.

Value mapping

* Name

* Mappings

Type	Value	Mapped to
⋮ equals	0	⇒ gray
⋮ equals	1	⇒ green
⋮ equals	2	⇒ yellow
⋮ equals	3	⇒ red

[Add](#)

Parameters of a value mapping:

Parameter	Description
<i>Name</i>	Unique name for the set of value mappings.
<i>Mappings</i>	Individual rules for mapping numeric/string values to string representations.
<i>Type</i>	<p>Mapping is applied in the order of the rules that can be reordered by dragging.</p> <p>Mapping type:</p> <p>equals - equal values will be mapped;</p> <p>is greater than or equals - equal or greater values will be mapped;</p> <p>is less than or equals - equal or smaller values will be mapped;</p> <p>in range - values in range will be mapped; the range is expressed as <number1>-<number2> or <number>; multiple ranges are supported (for example, 1-10,101-110,201);</p> <p>regexp - values corresponding to the regular expression will be mapped (global regular expressions are not supported);</p> <p>default - all outstanding values will be mapped, other than those with specific mappings.</p>
<i>Value</i>	For mapping ranges, only numeric value types (<i>is greater than or equals</i> , <i>is less than or equals</i> , <i>in range</i>) are supported.
<i>Mapped to</i>	<p>Incoming value (may contain a range or regular expression, depending on the mapping type).</p> <p>String representation (up to 64 characters) for the incoming value.</p>

All mandatory input fields are marked with a red asterisk.

When viewing the value mapping in the list, only the first three mappings are visible, with three dots indicating that more mappings exist.

Template Tags 2 Macros 6 Value mapping 1

Value mapping	Name	Value	Action
	VMware status	=0 ⇒ gray =1 ⇒ green =2 ⇒ yellow ...	Remove
	Add		

Value mapping example

One of the predefined agent items *Zabbix agent ping* uses a template-level value mapping "Zabbix agent ping status" to display its values.

Value mapping

* Name

* Mappings

Type	Value	Mapped to
<input type="text" value="equals"/>	<input type="text" value="1"/>	<input type="text" value="Up"/>

In the item **configuration form**, you can find a reference to this value mapping in the *Value mapping* field:

Value mapping

This mapping is used in the *Monitoring → Latest data* section to display "Up" (with the raw value in parentheses).

▼ <input type="checkbox"/> Host ▲	Name	Last check	Last value
▼ <u>Zabbix server</u>	Monitoring agent (1 Item)		
<input type="checkbox"/>	Zabbix agent ping ?	02/23/2021 04:27:07 PM	Up (1)

Note:

In the *Latest data* section, displayed values are shortened to 20 symbols. If value mapping is used, this shortening is not applied to the mapped value but only to the raw value (displayed in parentheses).

Without a predefined value mapping, you would only see "1", which might be challenging to understand.

▼ <input type="checkbox"/> Host ▲	Name	Last check	Last value
▼ <u>Zabbix server</u>	Monitoring agent (1 Item)		
<input type="checkbox"/>	Zabbix agent ping ?	02/23/2021 06:00:07 PM	1

9 Queue

Overview

The queue displays items that are waiting for a refresh. The queue is just a **logical** representation of data. There is no IPC queue or any other queue mechanism in Zabbix.

Items monitored by proxies are also included in the queue - they will be counted as queued for the proxy history data update period.

Only items with scheduled refresh times are displayed in the queue. This means that the following item types are excluded from the queue:

- log, logrt and event log active Zabbix agent items
- SNMP trap items
- trapper items
- web monitoring items
- dependent items

Statistics shown by the queue is a good indicator of the performance of Zabbix server.

The queue is retrieved directly from Zabbix server using JSON protocol. The information is available only if Zabbix server is running.

Attention:

Items are not counted in the queue if the item interface becomes unavailable due to connection problems or agent not working properly.

Reading the queue

To read the queue, go to *Administration* → *Queue*.

Queue overview ▼						
Items	5 seconds	10 seconds	30 seconds	1 minute	5 minutes	More than 10 minutes
Zabbix agent	1	11	1	0	0	0
Zabbix agent (active)	0	0	0	0	0	0
Simple check	0	0	0	0	0	0
SNMPv1 agent	0	0	0	0	0	0
SNMPv2 agent	0	0	0	0	0	0
SNMPv3 agent	0	0	0	0	0	0
Zabbix internal	0	0	0	0	0	0
Zabbix aggregate	0	0	0	0	0	0
External check	0	0	0	0	0	0
Database monitor	0	0	0	0	0	0
HTTP agent	0	0	0	0	0	0

The picture here is generally "ok" so we may assume that the server is doing fine.

The queue shows some items waiting up to 30 seconds. It would be great to know what items these are.

To do just that, select *Queue details* in the title dropdown. Now you can see a list of those delayed items.

☰ Queue details ▾

Scheduled check	Delayed by	Host	Name	Proxy
2019-09-02 11:46:40	58s	My host	CPU idle time	Remote proxy
2019-09-02 11:46:41	57s	My host	CPU interrupt time	Remote proxy
2019-09-02 11:46:42	56s	My host	CPU iowait time	Remote proxy
2019-09-02 11:46:43	55s	My host	CPU nice time	Remote proxy
2019-09-02 11:46:44	54s	My host	CPU softirq time	Remote proxy
2019-09-02 11:46:45	53s	My host	CPU steal time	Remote proxy
2019-09-02 11:46:46	52s	My host	CPU system time	Remote proxy

With these details provided it may be possible to find out why these items might be delayed.

With one or two delayed items there perhaps is no cause for alarm. They might get updated in a second. However, if you see a bunch of items getting delayed for too long, there might be a more serious problem.

See also: Aligning time zones when using [scheduling intervals](#).

☰ Queue overview ▾

Items	5 seconds	10 seconds	30 seconds	1 minute	5 minutes	More than 10 minutes
Zabbix agent	0	1	1	26	0	0
Zabbix agent (active)	0	0	0	0	0	0
Simple check	0	0	0	0	0	0
SNMPv1 agent	0	0	0	0	0	0
SNMPv2 agent	0	0	0	0	0	0
SNMPv3 agent	0	0	0	0	0	0
Zabbix internal	0	0	0	0	0	0
Zabbix aggregate	0	0	0	0	0	0
External check	0	0	0	0	0	0
Database monitor	0	0	0	0	0	0
HTTP agent	0	0	0	0	0	0
IPMI agent	0	0	0	0	0	0
SSH agent	0	0	0	0	0	0
TELNET agent	0	0	0	0	0	0
JMX agent	0	0	0	0	0	0
Calculated	0	0	0	0	0	0

Queue item

A special internal item **zabbix[queue,<from>,<to>]** can be used to monitor the health of the queue in Zabbix. It will return the number of items delayed by the set amount of time. For more information see [Internal items](#).

10 Value cache

Overview

To make the calculation of trigger expressions, calculated items and some macros much faster, a value cache option is supported by the Zabbix server.

This in-memory cache can be used for accessing historical data, instead of making direct SQL calls to the database. If historical values are not present in the cache, the missing values are requested from the database and the cache updated accordingly.

Item values remain in value cache either until:

- the item is deleted (cached values are deleted after the next configuration sync);
- the item value is outside the time or count range specified in the trigger/calculated item expression (cached value is removed when a new value is received);
- the time or count range specified in the trigger/calculated item expression is changed so that less data is required for calculation (unnecessary cached values are removed after 24 hours).

Note:

Value cache status can be observed by using the server **runtime control** option `diaginfo` (or `diaginfo=valuecache`) and inspecting the section for value cache diagnostic information. This can be useful for determining misconfigured triggers or calculated items.

To enable the value cache functionality, an optional **ValueCacheSize** parameter is supported by the Zabbix server **configuration** file.

Two internal items are supported for monitoring the value cache: **zabbix[valuecache,buffer,<mode>]** and **zabbix[valuecache,cache,<parameter>]**. See more details with **internal items**.

11 Execute now

Overview

Checking for a new item value in Zabbix is a cyclic process that is based on configured update intervals. While for many items the update intervals are quite short, there are others (including low-level discovery rules) for which the update intervals are quite long, so in real-life situations there may be a need to check for a new value quicker - to pick up changes in discoverable resources, for example. To accommodate such a necessity, it is possible to reschedule a passive check and retrieve a new value immediately.

This functionality is supported for **passive** checks only. The following item types are supported:

- Zabbix agent (passive)
- SNMPv1/v2/v3 agent
- IPMI agent
- Simple check
- Zabbix internal
- External check
- Database monitor
- JMX agent
- SSH agent
- Telnet
- Calculated
- HTTP agent
- Dependent item
- Script

Attention:

The check must be present in the configuration cache in order to get executed; for more information see **CacheUpdateFrequency**. Before executing the check, the configuration cache is **not** updated, thus very recent changes to item/discovery rule configuration will not be picked up. Therefore, it is also not possible to check for a new value for an item/rule that is being created or has been created just now; use the *Test* option while configuring an item for that.

Configuration

To execute a passive check immediately:

- click on *Execute now* for selected items in the list of latest data:

☰ Latest data

Subfilter affects only filtered data

HOSTS
Zabbix server 2

TAG VALUES
Application: General 2

<input checked="" type="checkbox"/>	Host	Name ▲	Last check
<input checked="" type="checkbox"/>	Zabbix server	Maximum number of open file descriptors ?	51m 54s
<input checked="" type="checkbox"/>	Zabbix server	Maximum number of processes ?	51m 53s

4 selected Display stacked graph Display graph **Execute now**

Several items can be selected and "executed now" at once.

In latest data this option is available only for hosts with read-write access. Accessing this option for hosts with read-only permissions depends on the **user role** option called *Invoke "Execute now" on read-only hosts*.

- click on *Execute now* in an existing item (or discovery rule) configuration form:

Enabled

Update Clone **Execute now** Test

- click on *Execute now* for selected items/rules in the list of items/discovery rules:

Template Module Linux network interfaces by Zabbix agent: Network interface discovery

1 selected Enable Disable **Execute now** Delete

Several items/rules can be selected and "executed now" at once.

12 Restricting agent checks

Overview

It is possible to restrict checks on the agent side by creating an item blacklist, a whitelist, or a combination of whitelist/blacklist.

To do that use a combination of two agent **configuration** parameters:

- `AllowKey=<pattern>` - which checks are allowed; `<pattern>` is specified using a wildcard (*) expression
- `DenyKey=<pattern>` - which checks are denied; `<pattern>` is specified using a wildcard (*) expression

Note that:

- All `system.run[*]` items (remote commands, scripts) are disabled by default, even when no deny keys are specified, it should be assumed that `DenyKey=system.run[*]` is implicitly appended.
- Since Zabbix 5.0.2 the `EnableRemoteCommands` agent parameter is:
 - deprecated by Zabbix agent
 - unsupported by Zabbix agent2

Therefore, to allow remote commands, specify an `AllowKey=system.run[<command>,*]` for each allowed command, * stands for wait and nowait mode. It is also possible to specify `AllowKey=system.run[*]` parameter to allow all commands with wait and nowait modes. To disallow specific remote commands, add `DenyKey` parameters with `system.run[]` commands before the `AllowKey=system.run[*]` parameter.

Important rules

- A whitelist without a deny rule is only allowed for `system.run[*]` items. For all other items, `AllowKey` parameters are not allowed without a `DenyKey` parameter; in this case Zabbix agent **will not start** with only `AllowKey` parameters.
- The order matters. The specified parameters are checked one by one according to their appearance order in the configuration file:
 - As soon as an item key matches an allow/deny rule, the item is either allowed or denied; and rule checking stops. So if an item matches both an allow rule and a deny rule, the result will depend on which rule comes first.
 - The order affects also `EnableRemoteCommands` parameter (if used).
- Unlimited numbers of `AllowKey/DenyKey` parameters is supported.
- `AllowKey`, `DenyKey` rules do not affect `HostnameItem`, `HostMetadataItem`, `HostInterfaceItem` configuration parameters.
- Key pattern is a wildcard expression where the wildcard (*) character matches any number of any characters in certain position. It might be used in both the key name and parameters.
- If a specific item key is disallowed in the agent configuration, the item will be reported as unsupported (no hint is given as to the reason);
- Zabbix agent with `--print (-p)` command line option will not show keys that are not allowed by configuration;
- Zabbix agent with `--test (-t)` command line option will return "Unsupported item key." status for keys that are not allowed by configuration;
- Denied remote commands will not be logged in the agent log (if `LogRemoteCommands=1`).

Use cases

Deny specific check

- Blacklist a specific check with `DenyKey` parameter. Matching keys will be disallowed. All non-matching keys will be allowed, except `system.run[]` items.

For example:

```
# Deny secure data access
DenyKey=vfs.file.contents[/etc/passwd,*]
```

Attention:

A blacklist may not be a good choice, because a new Zabbix version may have new keys that are not explicitly restricted by the existing configuration. This could cause a security flaw.

Deny specific command, allow others

- Blacklist a specific command with `DenyKey` parameter. Whitelist all other commands, with the `AllowKey` parameter.

```
# Disallow specific command
DenyKey=system.run[ls -l /]
```

```
# Allow other scripts
AllowKey=system.run[*]
```

Allow specific check, deny others

- Whitelist specific checks with `AllowKey` parameters, deny others with `DenyKey=*`

For example:

```
# Allow reading logs:
AllowKey=vfs.file.*[/var/log/*]

# Allow localtime checks
AllowKey=system.localtime[*]

# Deny all other keys
DenyKey=*
```

Pattern examples

Pattern	Description	Matches	No match
*	Matches all possible keys with or without parameters.	Any	None
<i>vfs.file.contents</i>	Matches <i>vfs.file.contents</i> without parameters.	<i>vfs.file.contents</i>	<i>vfs.file.contents[/etc/passwd]</i>
<i>vfs.file.contents[]</i>	Matches <i>vfs.file.contents</i> with empty parameters.	<i>vfs.file.contents[]</i>	<i>vfs.file.contents</i>
<i>vfs.file.contents[*]</i>	Matches <i>vfs.file.contents</i> with any parameters; will not match <i>vfs.file.contents</i> without square brackets.	<i>vfs.file.contents[]</i> <i>vfs.file.contents[/path/to/file]</i>	<i>vfs.file.contents</i>
<i>vfs.file.contents[/etc/passwd]</i>	Matches <i>vfs.file.contents</i> with first parameters matching <i>/etc/passwd</i> and all other parameters having any value (also empty).	<i>vfs.file.contents[/etc/passwd]</i> <i>vfs.file.contents[/etc/passwd,utf8]</i>	<i>vfs.file.contents[/etc/passwd]</i> <i>vfs.file.contents[/var/log/zabbix_...]</i>
<i>vfs.file.contents[*passwd]</i>	Matches <i>vfs.file.contents</i> with first parameter matching <i>*passwd*</i> and no other parameters.	<i>vfs.file.contents[/etc/passwd]</i>	<i>vfs.file.contents[/etc/passwd,utf8]</i>
<i>vfs.file.contents[*passwd*]</i>	Matches <i>vfs.file.contents</i> with only first parameter matching <i>*passwd*</i> and all following parameters having any value (also empty).	<i>vfs.file.contents[/etc/passwd]</i> <i>vfs.file.contents[/etc/passwd,tmp/test]utf8]</i>	<i>vfs.file.contents[/etc/passwd]</i>
<i>vfs.file.contents[/var/log/zabbix_server.log.*abc]</i>	Matches <i>vfs.file.contents</i> with first parameter matching <i>/var/log/zabbix_server.log</i> , third parameter matching <i>'abc'</i> and any (also empty) second parameter.	<i>vfs.file.contents[/var/log/zabbix_server.log,log,zabbix_...]</i> <i>vfs.file.contents[/var/log/zabbix_server.log,utf8,abc]</i>	<i>vfs.file.contents[/var/log/zabbix_...]</i>
<i>vfs.file.contents[/etc/passwd.*utf8]</i>	Matches <i>vfs.file.contents</i> with first parameter matching <i>/etc/passwd</i> , second parameter matching <i>'utf8'</i> and no other arguments.	<i>vfs.file.contents[/etc/passwd,utf8]</i>	<i>vfs.file.contents[/etc/passwd,]utf8]</i> <i>vfs.file.contents[/etc/passwd,utf1]</i>
<i>vfs.file.*</i>	Matches any keys starting with <i>vfs.file.</i> without any parameters.	<i>vfs.file.contents</i> <i>vfs.file.size</i>	<i>vfs.file.contents[]</i> <i>vfs.file.size[/var/log/zabbix_server_...]</i>
<i>vfs.file.*[*]</i>	Matches any keys starting with <i>vfs.file.</i> with any parameters.	<i>vfs.file.size.bytes[]</i> <i>vfs.file.size[/var/log/zabbix_server.log,utf8]</i>	<i>vfs.file.size.bytes</i>
<i>vfs.*.contents</i>	Matches any key starting with <i>vfs.</i> and ending with <i>.contents</i> without any parameters.	<i>vfs.mount.point.file.contents</i> <i>vfs..contents</i>	<i>vfs.contents</i>

system.run and AllowKey

A hypothetical script like 'myscript.sh' may be executed on a host via Zabbix agent in several ways:

1. As an item key in a passive or active check, for example:

- system.run[myscript.sh]
- system.run[myscript.sh,wait]
- system.run[myscript.sh,nowait]

Here the user may add "wait", "nowait" or omit the 2nd argument to use its default value in system.run[.].

2. As a global script (initiated by user in frontend or API).

A user configures this script in Alerts → Scripts, sets "Execute on: Zabbix agent" and puts "myscript.sh" into the script's "Commands" input field. When invoked from frontend or API the Zabbix server sends to agent:

- system.run[myscript.sh,wait] - up to Zabbix 5.0.4
- system.run[myscript.sh] - since 5.0.5

Here the user does not control the "wait"/"nowait" parameters.

3. As a remote command from an action. The Zabbix server sends to agent:

- system.run[myscript.sh,nowait]

Here again the user does not control the "wait"/"nowait" parameters.

What that means is if we set AllowKey like:

```
AllowKey=system.run[myscript.sh]
```

then

- system.run[myscript.sh] - will be allowed
- system.run[myscript.sh,wait], system.run[myscript.sh,nowait] will not be allowed - the script will not be run if invoked as a step of action

To allow all described variants you may add:

```
AllowKey=system.run[myscript.sh,*]  
DenyKey=system.run[*]
```

to the agent/agent2 parameters.

3 Triggers

Overview

Triggers are logical expressions that "evaluate" data gathered by items and represent the current system state.

While items are used to gather system data, it is highly impractical to follow these data all the time waiting for a condition that is alarming or deserves attention. The job of "evaluating" data can be left to trigger expressions.

Trigger expressions allow to define a threshold of what state of data is "acceptable". Therefore, should the incoming data surpass the acceptable state, a trigger is "fired" - or changes its status to PROBLEM.

A trigger may have the following status:

Status	Description
OK	This is a normal trigger status.
Problem	Something has happened. For example, the processor load is too high.
Unknown	The trigger value cannot be calculated. See Unknown status .

In a simple trigger we may want to set a threshold for a five-minute average of some data, for example, the CPU load. This is accomplished by defining a trigger expression where:

- the 'avg' function is applied to the value received in the item key
- a five minute period for evaluation is used
- a threshold of '2' is set

```
avg(/host/key,5m)>2
```

This trigger will "fire" (become PROBLEM) if the five-minute average is over 2.

In a more complex trigger, the expression may include a **combination** of multiple functions and multiple thresholds. See also: [Trigger expression](#).

Triggers cannot be created for items with binary values.

Note:

After enabling a trigger (changing its configuration status from *Disabled* to *Enabled*), the trigger expression is evaluated as soon as an item in it receives a value or the time to handle [date and time](#) and/or [nodata\(\)](#) functions comes.

Most trigger functions are evaluated based on item value [history](#) data, while some trigger functions for long-term analytics, e.g. [trendavg\(\)](#), [trendcount\(\)](#), etc, use trend data.

Calculation time

A trigger is recalculated every time Zabbix server receives a new value that is part of the expression. When a new value is received, each function that is included in the expression is recalculated (not just the one that received the new value).

Additionally, a trigger is recalculated each time when a new value is received **and** every 30 seconds if [date and time](#) and/or [nodata\(\)](#) functions are used in the expression.

Date and time and/or **nodata()** functions are recalculated every 30 seconds by the Zabbix history syncer process.

Triggers that reference trend functions **only** are evaluated once per the smallest time period in the expression. See also **trend functions**.

Evaluation period

An evaluation period is used in functions referencing the item history. It allows to specify the interval we are interested in. It can be specified as time period (30s, 10m, 1h) or as a value range (#5 - for five latest values).

The evaluation period is measured up to "now" - where "now" is the latest recalculation time of the trigger (see **Calculation time** above); "now" is not the "now" time of the server.

The evaluation period specifies either:

- To consider all values between "now-time period" and "now" (or, with time shift, between "now-time shift-time period" and "now-time_shift")
- To consider no more than the num count of values from the past, up to "now"
 - If there are 0 available values for the time period or num count specified - then the trigger or calculated item that uses this function becomes unsupported

Note that:

- If only a single function (referencing data history) is used in the trigger, "now" is always the latest received value. For example, if the last value was received an hour ago, the evaluation period will be regarded as up to the latest value an hour ago.
- A new trigger is calculated as soon as the first value is received (history functions); it will be calculated within 30 seconds for **date and time** and **nodata()** functions. Thus the trigger will be calculated even though perhaps the set evaluation period (for example, one hour) has not yet passed since the trigger was created. The trigger will also be calculated after the first value, even though the evaluation range was set, for example, to ten latest values.

Unknown status

It is possible that an unknown operand appears in a trigger expression if:

- an unsupported item is used
- the function evaluation for a supported item results in an error

In this case a trigger generally evaluates to "unknown" (although there are some exceptions). For more details, see **Expressions with unknown operands**.

It is possible to **get notified** on unknown triggers.

1 Configuring a trigger

Overview

To configure a trigger, do the following:

- Go to: *Data collection* → *Hosts*
- Click on *Triggers* in the row of the host
- Click on *Create trigger* to the right (or on the trigger name to edit an existing trigger)
- Enter parameters of the trigger in the form

See also **general information** on triggers and their calculation times.

Configuration

The **Trigger** tab contains all the essential trigger attributes.

All mandatory input fields are marked with a red asterisk.

Parameter	Description
<i>Name</i>	<p>Trigger name.</p> <p>Supported macros are: {HOST.HOST}, {HOST.NAME}, {HOST.PORT}, {HOST.CONN}, {HOST.DNS}, {HOST.IP}, {HOST.PORT}, {ITEM.VALUE}, {ITEM.LASTVALUE}, {ITEM.LOG.*} and {\$MACRO} user macros.</p> <p>\$1, \$2...\$9 macros can be used to refer to the first, second...ninth constant of the expression.</p> <p><i>Note:</i> \$1-\$9 macros will resolve correctly if referring to constants in relatively simple, straightforward expressions. For example, the name "Processor load above \$1 on {HOST.NAME}" will automatically change to "Processor load above 5 on New host" if the expression is last(/New host/system.cpu.load[percpu,avg1])>5</p>
<i>Event name</i>	<p>If defined, this name will be used to create the problem event name, instead of the trigger name. The event name may be used to build meaningful alerts containing problem data (see example). The same set of macros is supported as in the trigger name, plus {TIME}, {TIMESTAMP}, and {?EXPRESSION} expression macros.</p>
<i>Operational data</i>	<p>Operational data allow to define arbitrary strings along with macros. The macros will resolve dynamically to real time data in <i>Monitoring</i> → <i>Problems</i>. While macros in the trigger name (see above) will resolve to their values at the moment of a problem happening and will become the basis of a static problem name, the macros in the operational data maintain the ability to display the very latest information dynamically.</p>
<i>Severity</i>	<p>The same set of macros is supported as in the trigger name.</p> <p>Set the required trigger severity by clicking the buttons.</p>
<i>Expression</i>	<p>Logical expression used to define the conditions of a problem.</p> <p>A problem is created after all the conditions included in the expression are met, i.e. the expression evaluates to TRUE. The problem will be resolved as soon as the expression evaluates to FALSE, unless additional recovery conditions are specified in <i>Recovery expression</i>.</p>
<i>OK event generation</i>	<p>OK event generation options:</p> <p>Expression - OK events are generated based on the same expression as problem events;</p> <p>Recovery expression - OK events are generated if the problem expression evaluates to FALSE and the recovery expression evaluates to TRUE;</p> <p>None - in this case the trigger will never return to an OK state on its own.</p>

Parameter	Description
<i>Recovery expression</i>	Logical expression (optional) defining additional conditions that have to be met before the problem is resolved, after the original problem expression has already been evaluated as FALSE. Recovery expression is useful for trigger hysteresis . It is not possible to resolve a problem by recovery expression alone if the problem expression is still TRUE. This field is only available if 'Recovery expression' is selected for <i>OK event generation</i> .
<i>PROBLEM event generation mode</i>	Mode for generating problem events: Single - a single event is generated when a trigger goes into the 'Problem' state for the first time; Multiple - an event is generated upon every 'Problem' evaluation of the trigger.
<i>OK event closes</i>	Select if OK event closes: All problems - all problems of this trigger All problems if tag values match - only those trigger problems with matching event tag values
<i>Tag for matching</i>	Enter event tag name to use for event correlation. This field is displayed if 'All problems if tag values match' is selected for the <i>OK event closes</i> property and is mandatory in this case.
<i>Allow manual close</i>	Check to allow manual closing of problem events generated by this trigger. Manual closing is possible when acknowledging problem events.
<i>Menu entry name</i>	If not empty, the name entered here (up to 64 characters) is used in several frontend locations as a label for the trigger URL specified in the <i>Menu entry URL</i> parameter. If empty, the default name <i>Trigger URL</i> is used. The same set of macros is supported as in the trigger URL.
<i>Menu entry URL</i>	If not empty, the URL entered here (up to 2048 characters) is available as a link in the event menu in several frontend locations, for example, when clicking on the problem name in <i>Monitoring</i> → <i>Problems</i> or <i>Problems</i> dashboard widget. The same set of macros is supported as in the trigger name, plus {EVENT.ID}, {HOST.ID} and {TRIGGER.ID}. Note: user macros with secret values will not be resolved in the URL.
<i>Description</i>	Text field used to provide more information about this trigger. May contain instructions for fixing specific problem, contact detail of responsible staff, etc. The same set of macros is supported as in the trigger name.
<i>Enabled</i>	Unchecking this box will disable the trigger if required. Problems of a disabled trigger are no longer displayed in the frontend, but are not deleted.

The **Tags** tab allows you to define trigger-level **tags**. All problems of this trigger will be tagged with the values entered here.

Tags	Name	Value	Parent templates
	class	os	Remove Linux by Zabbix agent
	scope	performance	Remove Linux by Zabbix agent
	target	linux	Remove Linux by Zabbix agent

In addition the *Inherited and trigger tags* option allows to view tags defined on template level, if the trigger comes from that template. If there are multiple templates with the same tag, these tags are displayed once and template names are separated with commas. A trigger does not "inherit" and display host-level tags.

Parameter	Description
Name/Value	<p>Set custom tags to mark trigger events.</p> <p>Tags are a pair of tag name and value. You can use only the name or pair it with a value. A trigger may have several tags with the same name, but different values.</p> <p>User macros, user macros with context, low-level discovery macros and macro functions with <code>{{ITEM.VALUE}}</code>, <code>{{ITEM.LASTVALUE}}</code> and low-level discovery macros are supported in event tags. Low-level discovery macros can be used inside macro context.</p> <p><code>{TRIGGER.ID}</code> macro is supported in trigger tag values. It may be useful for identifying triggers created from trigger prototypes and, for example, suppressing problems from these triggers during maintenance.</p> <p>If the total length of expanded value exceeds 255, it will be cut to 255 characters.</p> <p>See all macros supported for event tags.</p> <p>Event tags can be used for event correlation, in action conditions and will also be seen in <i>Monitoring → Problems</i> or the <i>Problems</i> widget.</p>

The **Dependencies** tab contains all the **dependencies** of the trigger.

Click on *Add* to add a new dependency.

Note:

You can also configure a trigger by opening an existing one, pressing the *Clone* button and then saving under a different name.

Testing expressions

It is possible to test the configured trigger expression as to what the expression result would be depending on the received value.

The following expression from an official template is taken as an example:

```
avg(/Cisco IOS SNMPv2/sensor.temp.value[ciscoEnvMonTemperatureValue. {#SNMPINDEX}], 5m) > {$TEMP_WARN}
or
last(/Cisco IOS SNMPv2/sensor.temp.status[ciscoEnvMonTemperatureState. {#SNMPINDEX}]) = {$TEMP_WARN_STATUS}
```

To test the expression, click on *Expression constructor* under the expression field.

The screenshot shows the configuration interface for a trigger. The 'Trigger' tab is active. The 'Name' field contains 'Cisco IOS SNMPv2: Temperature is too high'. The 'Event name' field also contains 'Cisco IOS SNMPv2: Temperature is too high'. The 'Operational data' field is empty. The 'Severity' field has a dropdown menu with options: 'Not classified', 'Information', 'Warning' (selected), 'Average', 'High', and 'Disaster'. The 'Expression' field contains the following text:

```
avg(/Cisco IOS
SNMPv2/sensor.temp.value[ciscoEnvMonTemperature
Value. {#SNMPINDEX}], 5m) > {$TEMP_WARN}
or
last(/Cisco IOS
SNMPv2/sensor.temp.status[ciscoEnvMonTemperatur
eState. {#SNMPINDEX}]) = {$TEMP_WARN_STATUS}
```

To the right of the expression field is an 'Add' button. Below the expression field is a link labeled 'Expression constructor' with a green arrow pointing to it.

In the Expression constructor, all individual expressions are listed. To open the testing window, click on *Test* below the expression list.

Target Expression

Or

A `avg(/Cisco IOS SNMPv2/sensor.temp.value[ciscoEnvMonTemperatureValue.{#SNMPINDEX}],5m)>{$TEMP_WARN}`

B `last(/Cisco IOS SNMPv2/sensor.temp.status[ciscoEnvMonTemperatureState.{#SNMPINDEX}])={$TEMP_WARN_STATUS}`

Test 

In the testing window you can enter sample values ('80', '70', '0', '1' in this example) and then see the expression result, by clicking on the *Test* button.

Test ✕

Test data	Expression Variable Elements	Result type	Value
	<code>avg(/Cisco IOS SNMPv2/sensor.temp.value[ciscoEnvMonTemperatureValue.{#SNMPINDEX}],5m)</code>	Numeric (float)	<input type="text" value="80"/>
	<code>{\$TEMP_WARN}</code>	Any	<input type="text" value="70"/>
	<code>last(/Cisco IOS SNMPv2/sensor.temp.status[ciscoEnvMonTemperatureState.{#SNMPINDEX}])</code>	Numeric (integer)	<input type="text" value="0"/>
	<code>{\$TEMP_WARN_STATUS}</code>	Any	<input type="text" value="1"/>

Result	Expression	Result	Error
	Or	TRUE	
	A <code>avg(/Cisco IOS SNMPv2/sensor.temp.value[ciscoEnvMonTemperatureValue.{#SNMPINDEX}],...</code>	TRUE	
	B <code>last(/Cisco IOS SNMPv2/sensor.temp.status[ciscoEnvMonTemperatureState.{#SNMPINDEX}]...</code>	FALSE	
	A or B	TRUE	

The result of the individual expressions as well as the whole expression can be seen.

"TRUE" means that the specified expression is correct. In this particular case A, "80" is greater than the {\$TEMP_WARN} specified value, "70" in this example. As expected, a "TRUE" result appears.

"FALSE" means that the specified expression is incorrect. In this particular case B, {\$TEMP_WARN_STATUS} "1" needs to be equal with specified value, "0" in this example. As expected, a "FALSE" result appears.

The chosen expression type is "OR". If at least one of the specified conditions (A or B in this case) is TRUE, the overall result will be TRUE as well. Meaning that the current value exceeds the warning value and a problem has occurred.

2 Trigger expression

Overview

The expressions used in **triggers** are very flexible. You can use them to create complex logical tests regarding monitored statistics.

A simple expression uses a **function** that is applied to the item with some parameters. The function returns a result that is compared to the threshold, using an operator and a constant.

The syntax of a simple useful expression is `function(/host/key,parameter)<operator><constant>`.

For example:

```
min(/Zabbix server/net.if.in[eth0,bytes],5m)>100K
```

will trigger if the number of received bytes during the last five minutes was always over 100 kilobytes.

While the syntax is exactly the same, from the functional point of view there are two types of trigger expressions:

- problem expression - defines the conditions of the problem
- recovery expression (optional) - defines additional conditions of the problem resolution

When defining a problem expression alone, this expression will be used both as the problem threshold and the problem recovery threshold. As soon as the problem expression evaluates to TRUE, there is a problem. As soon as the problem expression evaluates to FALSE, the problem is resolved.

When defining both problem expression and the supplemental recovery expression, problem resolution becomes more complex: not only the problem expression has to be FALSE, but also the recovery expression has to be TRUE. This is useful to create **hysteresis** and avoid trigger flapping.

Note:

It is unproductive to use the {TRIGGER.VALUE} macro in a recovery expression because this expression is only evaluated when the trigger is in the "Problem" state. Consequently, {TRIGGER.VALUE} will always resolve to "1" (which indicates a "Problem" state) while evaluating the expression.

Functions

Functions allow to calculate the collected values (average, minimum, maximum, sum), find strings, reference current time and other factors.

A complete list of **supported functions** is available.

Typically functions return numeric values for comparison. When returning strings, comparison is possible with the = and <> operators (see **example**).

Function parameters

Function parameters allow to specify:

- host and item key (functions referencing the host item history only)
- function-specific parameters
- other expressions (not available for functions referencing the host item history, see **other expressions** for examples)

The host and item key can be specified as /host/key. The referenced item must be in a supported state (except for **nodata()** function, which is calculated for unsupported items as well).

While other trigger expressions as function parameters are limited to non-history functions in triggers, this limitation does not apply in **calculated items**.

Function-specific parameters

Function-specific parameters are placed after the item key and are separated from the item key by a comma. See the **supported functions** for a complete list of these parameters.

Most of numeric functions accept time as a parameter. You may use seconds or **time suffixes** to indicate time. Preceded by a hash mark, the parameter has a different meaning:

Expression	Description
sum(/host/key,10m)	Sum of values in the last 10 minutes.
sum(/host/key,#10)	Sum of the last ten values.

Parameters with a hash mark have a different meaning with the function **last** - they denote the Nth previous value, so given the values 30, 70, 20, 60, 50 (from the most recent to the least recent):

- last(/host/key,#2) would return '70'
- last(/host/key,#5) would return '50'

Time shift

An optional time shift is supported with time or value count as the function parameter. This parameter allows to reference data from a period of time in the past.

Time shift starts with now - specifying the current time, and is followed by +N<time unit> or -N<time unit> - to add or subtract N time units.

For example, avg(/host/key,1h:now-1d) will return the average value for an hour one day ago.

Attention:

Time shift specified in months (M) and years (y) is only supported for **trend functions**. Other functions support seconds (s), minutes (m), hours (h), days (d), and weeks (w).

Time shift with absolute time periods

Absolute time periods are supported in the time shift parameter, for example, midnight to midnight for a day, Monday-Sunday for a week, first day-last day of the month for a month.

Time shift for absolute time periods starts with now - specifying the current time, and is followed by any number of time operations: /<time unit> - defines the beginning and end of the time unit, for example, midnight to midnight for a day, +N<time unit> or -N<time unit> - to add or subtract N time units.

Please note that the value of time shift can be greater or equal to 0, while the time period minimum value is 1.

Parameter	Description
1d:now/d	Yesterday
1d:now/d+1d	Today
2d:now/d+1d	Last 2 days
1w:now/w	Last week
1w:now/w+1w	This week

Other expressions

Function parameters may contain other expressions, as in the following syntax:

```
min(min(/host/key,1h),min(/host2/key2,1h)*10)
```

Note that other expressions may not be used, if the function references item history. For example, the following syntax is not allowed:

```
min(/host/key,#5*10)
```

Operators

The following operators are supported for triggers **(in descending priority of execution)**:

Priority	Operator	Definition	Notes for unknown values	Force cast operand to float ¹
1	-	Unary minus	-Unknown → Unknown	Yes
2	not	Logical NOT	not Unknown → Unknown	Yes
3	*	Multiplication	0 * Unknown → Unknown (yes, Unknown, not 0 - to not lose Unknown in arithmetic operations) 1.2 * Unknown → Unknown	Yes
	/	Division	Unknown / 0 → error Unknown / 1.2 → Unknown 0.0 / Unknown → Unknown	Yes
4	+	Arithmetical plus	1.2 + Unknown → Unknown	Yes
	-	Arithmetical minus	1.2 - Unknown → Unknown	Yes
5	<	Less than. The operator is defined as: A<B ⇔ (A<B-0.000001)	1.2 < Unknown → Unknown	Yes
	<=	Less than or equal to. The operator is defined as: A<=B ⇔ (A≤B+0.000001)	Unknown <= Unknown → Unknown	Yes
	>	More than. The operator is defined as: A>B ⇔ (A>B+0.000001)		Yes

Priority	Operator	Definition	Notes for unknown values	Force cast operand to float ¹
	>=	More than or equal to. The operator is defined as: A>=B ⇔ (A≥B-0.000001)		Yes
6	=	Is equal. The operator is defined as: A=B ⇔ (A≥B-0.000001) and (A≤B+0.000001)		No ¹
	<>	Not equal. The operator is defined as: A<>B ⇔ (A<B-0.000001) or (A>B+0.000001)		No ¹
7	and	Logical AND	0 and Unknown → 0 1 and Unknown → Unknown Unknown and Unknown → Unknown	Yes
8	or	Logical OR	1 or Unknown → 1 0 or Unknown → Unknown Unknown or Unknown → Unknown	Yes

¹ String operand is still cast to numeric if:

- another operand is numeric
- operator other than = or <> is used on an operand

(If the cast fails - numeric operand is cast to a string operand and both operands get compared as strings.)

not, **and** and **or** operators are case-sensitive and must be in lowercase. They also must be surrounded by spaces or parentheses.

All operators, except unary - and **not**, have left-to-right associativity. Unary - and **not** are non-associative (meaning **-(1)** and **not (not 1)** should be used instead of **--1** and **not not 1**).

Evaluation result:

- <, <=, >, >=, =, <> operators shall yield '1' in the trigger expression if the specified relation is true and '0' if it is false. If at least one operand is Unknown the result is Unknown;
- **and** for known operands shall yield '1' if both of its operands compare unequal to '0'; otherwise, it yields '0'; for unknown operands **and** yields '0' only if one operand compares equal to '0'; otherwise, it yields 'Unknown';
- **or** for known operands shall yield '1' if either of its operands compare unequal to '0'; otherwise, it yields '0'; for unknown operands **or** yields '1' only if one operand compares unequal to '0'; otherwise, it yields 'Unknown';
- The result of the logical negation operator **not** for a known operand is '0' if the value of its operand compares unequal to '0'; '1' if the value of its operand compares equal to '0'. For unknown operand **not** yields 'Unknown'.

Value caching

Values required for trigger evaluation are cached by Zabbix server. Because of this trigger evaluation causes a higher database load for some time after the server restarts. The value cache is not cleared when item history values are removed (either manually or by housekeeper), so the server will use the cached values until they are older than the time periods defined in trigger functions or server is restarted.

Note:

If there is no recent data in the cache and there is no defined querying period in the function, Zabbix will by default go as far back in the past as one week to query the database for historical values.

Examples of triggers**Example 1**

The processor load is too high on Zabbix server.

```
last(/Zabbix server/system.cpu.load[all,avg1])>5
```

By using the function 'last()', we are referencing the most recent value. /Zabbix server/system.cpu.load[all,avg1] gives a short name of the monitored parameter. It specifies that the host is 'Zabbix server' and the key being monitored is 'system.cpu.load[all,avg1]'. Finally, >5 means that the trigger is in the PROBLEM state whenever the most recent processor load measurement from Zabbix server is greater than 5.

Example 2

www.example.com is overloaded.

```
last(/www.example.com/system.cpu.load[all,avg1])>5 or min(/www.example.com/system.cpu.load[all,avg1],10m)>2
```

The expression is true when either the current processor load is more than 5 or the processor load was more than 2 during last 10 minutes.

Example 3

/etc/passwd has been changed.

```
last(/www.example.com/vfs.file.cksum[/etc/passwd],#1)<>last(/www.example.com/vfs.file.cksum[/etc/passwd],#1)
```

The expression is true when the previous value of /etc/passwd checksum differs from the most recent one.

Similar expressions could be useful to monitor changes in important files, such as /etc/passwd, /etc/inetd.conf, /kernel, etc.

Example 4

Someone is downloading a large file from the Internet.

Use of function min:

```
min(/www.example.com/net.if.in[eth0,bytes],5m)>100K
```

The expression is true when number of received bytes on eth0 is more than 100 KB within last 5 minutes.

Example 5

Both nodes of clustered SMTP server are down.

Note use of two different hosts in one expression:

```
last(/smtp1.example.com/net.tcp.service[smtp])=0 and last(/smtp2.example.com/net.tcp.service[smtp])=0
```

The expression is true when both SMTP servers are down on both smtp1.example.com and smtp2.example.com.

Example 6

Zabbix agent needs to be upgraded.

Use of function find():

```
find(/example.example.com/agent.version,,"like","beta8")=1
```

The expression is true if Zabbix agent has version beta8.

Example 7

Server is unreachable.

```
count(/example.example.com/icmpping,30m,,"0")>5
```

The expression is true if host "example.example.com" is unreachable more than 5 times in the last 30 minutes.

Example 8

No heartbeats within last 3 minutes.

Use of function nodata():

```
nodata(/example.example.com/tick,3m)=1
```

To make use of this trigger, 'tick' must be defined as a Zabbix **trapper** item. The host should periodically send data for this item using `zabbix_sender`. If no data is received within 180 seconds, the trigger value becomes PROBLEM.

Note that 'nodata' can be used for any item type.

Example 9

CPU activity at night time.

Use of function `time()`:

```
min(/Zabbix_server/system.cpu.load[all,avg1],5m)>2 and time()<060000
```

The trigger may change its state to problem only at night time (00:00 - 06:00).

Example 10

CPU activity at any time with exception.

Use of function `time()` and **not** operator:

```
min(/zabbix/system.cpu.load[all,avg1],5m)>2
and not (dayofweek()=7 and time()>230000)
and not (dayofweek()=1 and time()<010000)
```

The trigger may change its state to problem at any time, except for 2 hours on a week change (Sunday, 23:00 - Monday, 01:00).

Example 11

Check if client local time is in sync with Zabbix server time.

Use of function `fuzzytime()`:

```
fuzzytime(/MySQL_DB/system.localtime,10s)=0
```

The trigger will change to the problem state in case when local time on server MySQL_DB and Zabbix server differs by more than 10 seconds. Note that 'system.localtime' must be configured as a **passive check**.

Example 12

Comparing average load today with average load of the same time yesterday (using time shift as `now-1d`).

```
avg(/server/system.cpu.load,1h)/avg(/server/system.cpu.load,1h:now-1d)>2
```

The trigger will fire if the average load of the last hour tops the average load of the same hour yesterday more than two times.

Example 13

Using the value of another item to get a trigger threshold:

```
last(/Template PfSense/hrStorageFree[#{SNMPVALUE}])<last(/Template PfSense/hrStorageSize[#{SNMPVALUE}])*0.1
```

The trigger will fire if the free storage drops below 10 percent.

Example 14

Using **evaluation result** to get the number of triggers over a threshold:

```
(last(/server1/system.cpu.load[all,avg1])>5) + (last(/server2/system.cpu.load[all,avg1])>5) + (last(/server3/system.cpu.load[all,avg1])>5)>2
```

The trigger will fire if at least two of the triggers in the expression are in a problem state.

Example 15

Comparing string values of two items - operands here are functions that return strings.

Problem: create an alert if Ubuntu version is different on different hosts

```
last(/NY Zabbix_server/vfs.file.contents[/etc/os-release])<>last(/LA Zabbix_server/vfs.file.contents[/etc/os-release])
```

Example 16

Comparing two string values - operands are:

- a function that returns a string
- a combination of macros and strings

Problem: detect changes in the DNS query

The item key is:

```
net.dns.record[192.0.2.0,{$WEBSITE_NAME},{DNS_RESOURCE_RECORD_TYPE},2,1]
```

with macros defined as

```
{WEBSITE_NAME} = example.com  
{DNS_RESOURCE_RECORD_TYPE} = MX
```

and normally returns:

```
example.com          MX          0 mail.example.com
```

So our trigger expression to detect if the DNS query result deviated from the expected result is:

```
last(/Zabbix server/net.dns.record[192.0.2.0,{$WEBSITE_NAME},{DNS_RESOURCE_RECORD_TYPE},2,1])<>"{WEBSITE
```

Notice the quotes around the second operand.

Example 17

Comparing two string values - operands are:

- a function that returns a string
- a string constant with special characters \ and "

Problem: detect if the /tmp/hello file content is equal to:

```
\ " //hello ?\"
```

Option 1) write the string directly

```
last(/Zabbix server/vfs.file.contents[/tmp/hello])="\\ \" //hello ?\\ \"
```

Notice how \ and " characters are escaped when the string gets compared directly.

Option 2) use a macro

```
{HELLO_MACRO} = \" //hello ?\"
```

in the expression:

```
last(/Zabbix server/vfs.file.contents[/tmp/hello])={HELLO_MACRO}
```

Example 18

Comparing long-term periods.

Problem: Load of Exchange server increased by more than 10% last month

```
trendavg(/Exchange/system.cpu.load,1M:now/M)>1.1*trendavg(/Exchange/system.cpu.load,1M:now/M-1M)
```

You may also use the **Event name** field in trigger configuration to build a meaningful alert message, for example to receive something like

```
"Load of Exchange server increased by 24% in July (0.69) comparing to June (0.56)"
```

the event name must be defined as:

```
Load of {HOST.HOST} server increased by {{?100*trendavg(/system.cpu.load,1M:now/M)/trendavg(/system.cpu.
```

It is also useful to allow manual closing in trigger configuration for this kind of problem.

Hysteresis

Sometimes an interval is needed between problem and recovery states, rather than a simple threshold. For example, if we want to define a trigger that reports a problem when server room temperature goes above 20°C and we want it to stay in the problem state until the temperature drops below 15°C, a simple trigger threshold at 20°C will not be enough.

Instead, we need to define a trigger expression for the problem event first (temperature above 20°C). Then we need to define an additional recovery condition (temperature below 15°C). This is done by defining an additional *Recovery expression* parameter when **defining** a trigger.

In this case, problem recovery will take place in two steps:

- First, the problem expression (temperature above 20°C) will have to evaluate to FALSE
- Second, the recovery expression (temperature below 15°C) will have to evaluate to TRUE

The recovery expression will be evaluated only when the problem event is resolved first.

Warning:

The recovery expression being TRUE alone does not resolve a problem if the problem expression is still TRUE!

Example 1

Temperature in server room is too high.

Problem expression:

```
last(/server/temp)>20
```

Recovery expression:

```
last(/server/temp)<=15
```

Example 2

Free disk space is too low.

Problem expression: it is less than 10GB for last 5 minutes

```
max(/server/vfs.fs.size[/,free],5m)<10G
```

Recovery expression: it is more than 40GB for last 10 minutes

```
min(/server/vfs.fs.size[/,free],10m)>40G
```

Expressions with unknown operands

Generally an unknown operand (such as an unsupported item) in the expression will immediately render the trigger value to `Unknown`.

However, in some cases unknown operands (unsupported items, function errors) are admitted into expression evaluation:

- The `nodata()` function is evaluated regardless of whether the referenced item is supported or not.
- Logical expressions with OR and AND can be evaluated to known values in two cases regardless of unknown operands:
 - **Case 1:** "1 or some_function(unsupported_item1) or some_function(unsupported_item2) or ..." can be evaluated to known result ('1' or "Problem"),
 - **Case 2:** "0 and some_function(unsupported_item1) and some_function(unsupported_item2) and ..." can be evaluated to known result ('0' or "OK").Zabbix tries to evaluate such logical expressions by taking unsupported items as unknown operands. In the two cases above a known value will be produced ("Problem" or "OK", respectively); in **all other** cases the trigger will evaluate to `Unknown`.
- If the function evaluation for a supported item results in error, the function value becomes `Unknown` and it takes part as unknown operand in further expression evaluation.

Note that unknown operands may "disappear" only in logical expressions as described above. In arithmetic expressions unknown operands always lead to the result `Unknown` (except division by 0).

Attention:

An expression that results in `Unknown` does not change the trigger state ("Problem/OK"). So, if it was "Problem" (see Case 1), it stays in the same problem state even if the known part is resolved ('1' becomes '0'), because the expression is now evaluated to `Unknown` and that does not change the trigger state.

If a trigger expression with several unsupported items evaluates to `Unknown` the error message in the frontend refers to the last unsupported item evaluated.

3 Trigger dependencies

Overview

Sometimes the availability of one host depends on another. A server that is behind a router will become unreachable if the router goes down. With triggers configured for both, you might get notifications about two hosts down - while only the router was the guilty party.

This is where some dependency between hosts might be useful. With dependency set, notifications of the dependents could be withheld and only the notification on the root problem sent.

While Zabbix does not support dependencies between hosts directly, they may be defined with another, more flexible method - trigger dependencies. A trigger may have one or more triggers it depends on.

So in our simple example we open the server trigger configuration form and set that it depends on the respective trigger of the router. With such dependency, the server trigger will not change its state as long as the trigger it depends on is in the 'PROBLEM' state - and thus no dependent actions will be taken and no notifications sent.

If both the server and the router are down and dependency is there, Zabbix will not execute actions for the dependent trigger.

While the parent trigger is in the PROBLEM state, its dependents may report values that cannot be trusted. Therefore dependent triggers will not be re-evaluated until the parent trigger (the router in the example above):

- goes back from 'PROBLEM' to 'OK' state;
- changes its state from 'PROBLEM' to 'UNKNOWN';
- is closed manually, by correlation or with the help of `date and time` and/or `nodata()` functions;
- is resolved by a value of an item not involved in the dependent trigger;
- is disabled, has a disabled item or a disabled item host

In all of the cases mentioned above, the dependent trigger (server) will be re-evaluated only when a new metric for it is received. This means that the dependent trigger may not be updated immediately.

Also:

- Trigger dependency may be added from any host trigger to any other host trigger, as long as it doesn't result in a circular dependency.
- Trigger dependency may be added from one template to another. If some trigger from template A depends on some trigger from template B, template A may only be linked to a host (or another template) together with template B, but template B may be linked to a host (or another template) alone.
- Trigger dependency may be added from a template trigger to a host trigger. In this case, linking such a template to a host will create a host trigger that depends on the same trigger template that the trigger was depending on. This allows to, for example, have a template where some triggers depend on the router (host) triggers. All hosts linked to this template will depend on that specific router.
- Trigger dependency may not be added from a host trigger to a template trigger.
- Trigger dependency may be added from a trigger prototype to another trigger prototype (within the same low-level discovery rule) or a real trigger. A trigger prototype may not depend on a trigger prototype from a different LLD rule or on a trigger created from trigger prototype. A host trigger prototype cannot depend on a trigger from a template.

Configuration

To define a dependency, open the Dependencies tab in the trigger **configuration form**. Click on *Add* in the 'Dependencies' block and select one or more triggers that the trigger will depend on.

Name	Action
My host: Load average is too high (per CPU load over {\$LOAD_AVG_PER_CPU.MAX.WARN} for 5m)	Remove

Buttons: Update, Clone, Delete, Cancel

Click *Update*. Now the trigger has the indication of its dependency in the list.

Template Module Linux CPU by Zabbix agent: High CPU utilization
(over {\$CPU.UTIL.CRIT}% for 5m)
Depends on:
My host: Load average is too high (per CPU load over {\$LOAD_AVG_PER_CPU.MAX.WARN} for 5m)

Example of several dependencies

For example, the Host is behind the Router2 and the Router2 is behind the Router1.

Zabbix - Router1 - Router2 - Host

If the Router1 is down, then obviously the Host and the Router2 are also unreachable, yet receiving three notifications about the Host, the Router1 and the Router2 all being down is excessive.

So in this case we define two dependencies:

the 'Host is down' trigger depends on the 'Router2 is down' trigger
the 'Router2 is down' trigger depends on the 'Router1 is down' trigger

Before changing the status of the 'Host is down' trigger, Zabbix will check for the corresponding trigger dependencies. If such are found and one of those triggers is in the 'Problem' state, then the trigger status will not be changed, the actions will not be executed and no notifications will be sent.

Zabbix performs this check recursively. If the Router1 or the Router2 is unreachable, the Host trigger won't be updated.

4 Trigger severity

Trigger severity represents the level of importance of a trigger.



Zabbix supports the following default trigger severities.

Severity	Color	Description
Not classified	Gray	Can be used where the severity level of an event is unknown, has not been determined, is not part of the regular monitoring scope, etc., for example, during initial configuration, as a placeholder for future assessment, or as part of an integration process.
Information	Light blue	Can be used for informational events that do not require immediate attention, but can still provide valuable insights.
Warning	Yellow	Can be used to indicate a potential issue that might require investigation or action, but that is not critical.
Average	Orange	Can be used to indicate a significant issue that should be addressed relatively soon to prevent further problems.
High	Light red	Can be used to indicate critical issues that need immediate attention to avoid significant disruptions.
Disaster	Red	Can be used to indicate a severe incident that requires immediate action to prevent, for example, system outages or data loss.

Note:

Trigger severity names and colors can be **customized**.

Trigger severities are used for:

- visual representation of triggers - different colors for different severities;
- audio in global alarms - different audio for different severities;
- user media - different media (notification channel) for different severities (for example, SMS for triggers of *High* and *Disaster* severity, and Email for triggers of other severities);
- limiting actions by conditions against trigger severities.

5 Customizing trigger severities

Trigger severity names and colors for severity related GUI elements can be configured in *Administration* → *General* → *Trigger displaying options*. Colors are shared among all GUI themes.

Translating customized severity names

Attention:

If Zabbix frontend translations are used, custom severity names will override translated names by default.

Default trigger severity names are available for translation in all locales. If a severity name is changed, a custom name is used in all locales and additional manual translation is needed.

Custom severity name translation procedure:

- set required custom severity name, for example, 'Important'
- edit `<frontend_dir>/locale/<required_locale>/LC_MESSAGES/frontend.po`
- add 2 lines:

```
msgid "Important"
msgstr "<translation string>"
```

and save file.

- create .mo files as described in <frontend_dir>/locale/README

Here **msgid** should match the new custom severity name and **msgstr** should be the translation for it in the specific language.

This procedure should be performed after each severity name change.

6 Mass update

Overview

With mass update you may change some attribute for a number of triggers at once, saving you the need to open each individual trigger for editing.

Using mass update

To mass-update some triggers, do the following:

- Mark the checkboxes of the triggers you want to update in the list
- Click on *Mass update* below the list
- Navigate to the tab with required attributes (*Trigger*, *Tags* or *Dependencies*)
- Mark the checkboxes of any attribute to update

Mass update

Trigger **Tags** Dependencies

Severity Not classified Information Warning Average High Disaster

Allow manual close Original

Mass update

Trigger **Tags** Dependencies

Tags Add Replace Remove

Name	Value
<input type="text" value="tag"/>	<input type="text" value="value"/>

[Add](#)

The following options are available when selecting the respective button for tag update:

- *Add* - allows to add new tags for the triggers;
- *Replace* - will remove any existing tags from the trigger and replace them with the one(s) specified below;
- *Remove* - will remove specified tags from triggers.

Note that tags with the same name but different values are not considered 'duplicates' and can be added to the same trigger.

Mass update

Trigger Tags Dependencies

Replace dependencies

Name

Zabbix server: Lack of available memory (< 20M of 7.72 GB)

[Add](#)

Replace dependencies - will remove any existing dependencies from the trigger and replace them with the one(s) specified.

Click on *Update* to apply the changes.

7 Predictive trigger functions

Overview

Sometimes there are signs of the upcoming problem. These signs can be spotted so that actions may be taken in advance to prevent or at least minimize the impact of the problem.

Zabbix has tools to predict the future behavior of the monitored system based on historic data. These tools are realized through predictive trigger functions.

Functions

Before setting a trigger, it is necessary to define what a problem state is and how much time is needed to take action. Then there are two ways to set up a trigger signaling about a potential unwanted situation. First: the trigger must fire when the system is expected to be in a problem state after "time to act". Second: the trigger must fire when the system is going to reach the problem state in less than "time to act". Corresponding trigger functions to use are **forecast** and **timeleft**. Note that underlying statistical analysis is basically identical for both functions. You may set up a trigger whichever way you prefer with similar results.

Parameters

Both functions use almost the same set of parameters. Use the list of [supported functions](#) for reference.

Time interval

First of all, you should specify the historic period Zabbix should analyze to come up with the prediction. You do it in a familiar way by means of the `time period` parameter and optional time shift like you do it with **avg**, **count**, **delta**, **max**, **min** and **sum** functions.

Forecasting horizon

(**forecast** only)

Parameter `time` specifies how far in the future Zabbix should extrapolate dependencies it finds in historic data. No matter if you use `time_shift` or not, `time` is always counted starting from the current moment.

Threshold to reach

(**timeleft** only)

Parameter `threshold` specifies a value the analyzed item has to reach, no difference if from above or from below. Once we have determined $f(t)$ (see below), we should solve equation $f(t) = \text{threshold}$ and return the root which is closer to now and to the right from now or $1.7976931348623158E+308$ if there is no such root.

Note:

When item values approach the threshold and then cross it, **timeleft** assumes that intersection is already in the past and therefore switches to the next intersection with `threshold` level, if any. Best practice should be to use predictions as a complement to ordinary problem diagnostics, not as a substitution.¹

Fit functions

Default `fit` is the *linear* function. But if your monitored system is more complicated you have more options to choose from.

<code>fit</code>	$x = f(t)$
<i>linear</i>	$x = a + b*t$

fit	x = f(t)
<i>polynomial</i> ²	$x = a_0 + a_1*t + a_2*t^2 + \dots + a_n*t^n$
<i>exponential</i>	$x = a*\exp(b*t)$
<i>logarithmic</i>	$x = a + b*\log(t)$
<i>power</i>	$x = a*t^b$

Modes

(forecast only)

Every time a trigger function is evaluated, it gets data from the specified history period and fits a specified function to the data. So, if the data is slightly different, the fitted function will be slightly different. If we simply calculate the value of the fitted function at a specified time in the future, you will know nothing about how the analyzed item is expected to behave between now and that moment in the future. For some *fit* options (like *polynomial*) a simple value from the future may be misleading.

mode	forecast result
<i>value</i>	$f(\text{now} + \text{time})$
<i>max</i>	$\max_{\text{now} \leq t \leq \text{now} + \text{time}} f(t)$
<i>min</i>	$\min_{\text{now} \leq t \leq \text{now} + \text{time}} f(t)$
<i>delta</i>	$\text{max} - \text{min}$
<i>avg</i>	average of $f(t)$ ($\text{now} \leq t \leq \text{now} + \text{time}$) according to definition

Details

To avoid calculations with huge numbers, we consider the timestamp of the first value in specified period plus 1 ns as a new zero-time (current epoch time is of order 10^9 , epoch squared is 10^{18} , double precision is about 10^{-16}). 1 ns is added to provide all positive time values for *logarithmic* and *power* fits which involve calculating $\log(t)$. Time shift does not affect *linear*, *polynomial*, *exponential* (apart from easier and more precise calculations) but changes the shape of *logarithmic* and *power* functions.

Potential errors

Functions return -1 in such situations:

- specified evaluation period contains no data;
- result of mathematical operation is not defined³;
- numerical complications (unfortunately, for some sets of input data range and precision of double-precision floating-point format become insufficient)⁴.

Note:

No warnings or errors are flagged if chosen fit poorly describes provided data or there is just too few data for accurate prediction.

Examples and dealing with errors

To get a warning when you are about to run out of free disk space on your host, you may use a trigger expression like this:

```
timeleft(/host/vfs.fs.size[/,free],1h,0)<1h
```

However, error code -1 may come into play and put your trigger in a problem state. Generally it's good because you get a warning that your predictions don't work correctly and you should look at them more thoroughly to find out why. But sometimes it's bad because -1 can simply mean that there was no data about the host free disk space obtained in the last hour. If you are getting too many false positive alerts, consider using more complicated trigger expression⁵:

```
timeleft(/host/vfs.fs.size[/,free],1h,0)<1h and timeleft(/host/vfs.fs.size[/,free],1h,0)<>-1
```

The situation is a bit more difficult with **forecast**. First of all, -1 may or may not put the trigger in a problem state depending on whether you have expression like `forecast(/host/item,...)<...` or like `forecast(/host/item,...)>...`

Furthermore, -1 may be a valid forecast if it's normal for the item value to be negative. But probability of this situation in the real world situation is negligible (see [how](#) the operator = works). So add `... or forecast(/host/item,...)=-1` or `... and forecast(/host/item,...)<>-1` if you want or don't want to treat -1 as a problem respectively.

Footnotes

¹ For example, a simple trigger like `timeleft(/host/item,1h,X) < 1h` may go into problem state when the item value approaches X and then suddenly recover once value X is reached. If the problem is item value being below X, use: `last(/host/item) < X` or `timeleft(/host/item,1h,X) < 1h` If the problem is item value being above X use: `last(/host/item) > X` or `timeleft(/host/item,1h,X) < 1h`

² Polynomial degree can be from 1 to 6, *polynomial1* is equivalent to *linear*. However, use higher degree polynomials [with caution](#). If the evaluation period contains less points than needed to determine polynomial coefficients, polynomial degree will be lowered (e.g., *polynomial5* is requested, but there are only 4 points, therefore *polynomial3* will be fitted).

³ For example, fitting *exponential* or *power* functions involves calculating $\log()$ of item values. If data contains zeros or negative numbers, you will get an error since $\log()$ is defined for positive values only.

⁴ For *linear*, *exponential*, *logarithmic* and *power* fits all necessary calculations can be written explicitly. For *polynomial* only *value* can be calculated without any additional steps. Calculating *avg* involves computing polynomial antiderivative (analytically). Computing *max*, *min* and *delta* involves computing polynomial derivative (analytically) and finding its roots (numerically). Solving $f(t) = 0$ involves finding polynomial roots (numerically).

⁵ But in this case -1 can cause your trigger to recover from the problem state. To be fully protected use: `timeleft(/host/vfs.fs.size[/,f and ({TRIGGER.VALUE}=0 and timeleft(/host/vfs.fs.size[/,free],1h,0)<>-1 or {TRIGGER.VALUE}=1)`

4 Events

Overview

There are several types of events generated in Zabbix:

- trigger events - whenever a trigger changes its status (*OK*→*PROBLEM*→*OK*)
- service events - whenever a service changes its status (*OK*→*PROBLEM*→*OK*)
- discovery events - when hosts or services are detected
- autoregistration events - when active agents are auto-registered by server
- internal events - when an item/low-level discovery rule becomes unsupported or a trigger goes into an unknown state

Events are time-stamped and can be the basis of actions such as sending notification email etc.

To view details of events in the frontend, go to *Monitoring* → *Problems*. There you can click on the event date and time to view details of an event.

More information is available on:

- [trigger events](#)
- [other event sources](#)

1 Trigger event generation

Overview

Change of trigger status is the most frequent and most important source of events. Each time the trigger changes its state, an event is generated. The event contains details of the trigger state's change - when it happened and what the new state is.

Two types of events are created by triggers - Problem and OK.

Problem events

A problem event is created:

- when a trigger expression evaluates to TRUE if the trigger is in OK state;
- each time a trigger expression evaluates to TRUE if multiple problem event generation is enabled for the trigger.

OK events

An OK event closes the related problem event(s) and may be created by 3 components:

- triggers - based on 'OK event generation' and 'OK event closes' settings;
- event correlation
- task manager - when an event is [manually closed](#)

Triggers

Triggers have an 'OK event generation' setting that controls how OK events are generated:

- *Expression* - an OK event is generated for a trigger in problem state when its expression evaluates to FALSE. This is the simplest setting, enabled by default.
- *Recovery expression* - an OK event is generated for a trigger in problem state when its expression evaluates to FALSE and the recovery expression evaluates to TRUE. This can be used if trigger recovery criteria is different from problem criteria.

- *None* - an OK event is never generated. This can be used in conjunction with multiple problem event generation to simply send a notification when something happens.

Additionally triggers have an 'OK event closes' setting that controls which problem events are closed:

- *All problems* - an OK event will close all open problems created by the trigger
- *All problems if tag values match* - an OK event will close open problems created by the trigger and having at least one matching tag value. The tag is defined by 'Tag for matching' trigger setting. If there are no problem events to close then OK event is not generated. This is often called trigger level event correlation.

Event correlation

Event correlation (also called global event correlation) is a way to set up custom event closing (resulting in OK event generation) rules.

The rules define how the new problem events are paired with existing problem events and allow to close the new event or the matched events by generating corresponding OK events.

However, event correlation must be configured very carefully, as it can negatively affect event processing performance or, if misconfigured, close more events than intended (in the worst case even all problem events could be closed). A few configuration tips:

1. always reduce the correlation scope by setting a unique tag for the control event (the event that is paired with old events) and use the 'new event tag' correlation condition
2. don't forget to add a condition based on the old event when using 'close old event' operation, or all existing problems could be closed
3. avoid using common tag names used by different correlation configurations

Task manager

If the 'Allow manual close' setting is enabled for trigger, then it's possible to manually close problem events generated by the trigger. This is done in the frontend when **updating a problem**. The event is not closed directly – instead a 'close event' task is created, which is handled by the task manager shortly. The task manager will generate a corresponding OK event and the problem event will be closed.

2 Other event sources

Service events

Service events are generated only if service actions for these events are enabled. In this case, each service status change creates a new event:

- Problem event - when service status is changed from OK to PROBLEM
- OK event - when service status is changed from PROBLEM to OK

The event contains details of the service state change - when it happened and what the new state is.

Discovery events

Zabbix periodically scans the IP ranges defined in network discovery rules. Frequency of the check is configurable for each rule individually. Once a host or a service is discovered, a discovery event (or several events) are generated.

Zabbix generates the following events:

Event	When generated
Service Up	Every time Zabbix detects active service.
Service Down	Every time Zabbix cannot detect service.
Host Up	If at least one of the services is UP for the IP.
Host Down	If all services are not responding.
Service Discovered	If the service is back after downtime or discovered for the first time.
Service Lost	If the service is lost after being up.
Host Discovered	If host is back after downtime or discovered for the first time.
Host Lost	If host is lost after being up.

Active agent autoregistration events

Active agent autoregistration creates events in Zabbix.

If configured, active agent autoregistration event is created when a previously unknown active agent asks for checks or if the host metadata has changed. The server adds a new auto-registered host, using the received IP address and port of the agent.

For more information, see the [active agent autoregistration](#) page.

Internal events

Internal events happen when:

- an item changes state from 'normal' to 'unsupported'
- an item changes state from 'unsupported' to 'normal'
- a low-level discovery rule changes state from 'normal' to 'unsupported'
- a low-level discovery rule changes state from 'unsupported' to 'normal'
- a trigger changes state from 'normal' to 'unknown'
- a trigger changes state from 'unknown' to 'normal'

The aim of introducing internal events is to allow users to be notified when any internal event takes place, for example, an item becomes unsupported and stops gathering data.

Internal events are only created when internal actions for these events are enabled. To stop generation of internal events (for example, for items becoming unsupported), disable all actions for internal events in Alerts → Actions → Internal actions.

Note:

If internal actions are disabled, while an object is in the 'unsupported' state, recovery event for this object will still be created.

If internal actions are enabled, while an object is in the 'unsupported' state, recovery event for this object will be created, even though 'problem event' has not been created for the object.

See also: [Receiving notification on unsupported items](#)

3 Manual closing of problems

Overview

While generally problem events are resolved automatically when trigger status goes from 'Problem' to 'OK', there may be cases when it is difficult to determine if a problem has been resolved by means of a trigger expression. In such cases, the problem needs to be resolved manually.

For example, *syslog* may report that some kernel parameters need to be tuned for optimal performance. In this case the issue is reported to Linux administrators, they fix it and then close the problem manually.

Problems can be closed manually only for triggers with the *Allow manual close* option enabled.

When a problem is "manually closed", Zabbix generates a new internal task for Zabbix server. Then the *task manager* process executes this task and generates an OK event, therefore closing problem event.

A manually closed problem does not mean that the underlying trigger will never go into a 'Problem' state again. The trigger expression is re-evaluated and may result in a problem:

- When new data arrive for any item included in the trigger expression (note that the values discarded by a throttling preprocessing step are not considered as received and will not cause trigger expression to be re-evaluated);
- When [date and time](#) and/or [nodata\(\)](#) functions are used in the expression.

Configuration

Two steps are required to close a problem manually.

Trigger configuration

In trigger configuration, enable the *Allow manual close* option.

Allow manual close

Problem update window

If a problem arises for a trigger with the *Manual close* flag, you can open the [problem update](#) popup window of that problem and close the problem manually.

To close the problem, check the *Close problem* option in the form and click on *Update*.

Update problem ✕

Message

History

Scope

Only selected problem

Selected and all other problems of related triggers 1 event

Change severity Not classified Information Warning Average High Disaster

Acknowledge

Close problem

* At least one update operation or message must exist.

All mandatory input fields are marked with a red asterisk.

The request is processed by Zabbix server. Normally it will take a few seconds to close the problem. During that process *CLOSING* is displayed in *Monitoring* → *Problems* as the status of the problem.

Verification

It can be verified that a problem has been closed manually:

- in event details, available through *Monitoring* → *Problems*;
- by using the {EVENT.UPDATE.HISTORY} macro in notification messages that will provide this information.

5 Event correlation

Overview

Event correlation allows to correlate problem events to their resolution in a manner that is very precise and flexible.

Event correlation can be defined:

- **on trigger level** - one trigger may be used to relate separate problems to their solution
- **globally** - problems can be correlated to their solution from a different trigger/polling method using global correlation rules

1 Trigger-based event correlation

Overview

Trigger-based event correlation allows to correlate separate problems reported by one trigger.

While generally an OK event can close all problem events created by one trigger, there are cases when a more detailed approach is needed. For example, when monitoring log files you may want to discover certain problems in a log file and close them individually rather than all together.

This is the case with triggers that have *PROBLEM event generation mode* parameter set to *Multiple*. Such triggers are normally used for log monitoring, trap processing, etc.

It is possible in Zabbix to relate problem events based on **tagging**. Tags are used to extract values and create identification for problem events. Taking advantage of that, problems can also be closed individually based on matching tag.

In other words, the same trigger can create separate events identified by the event tag. Therefore problem events can be identified one-by-one and closed separately based on the identification by the event tag.

How it works

In log monitoring you may encounter lines similar to these:

```
Line1: Service 1 stopped
Line2: Service 2 stopped
Line3: Service 1 was restarted
Line4: Service 2 was restarted
```

The idea of event correlation is to be able to match the problem event from Line1 to the resolution from Line3 and the problem event from Line2 to the resolution from Line4, and close these problems one by one:

```
Line1: Service 1 stopped
Line3: Service 1 was restarted #problem from Line 1 closed
```

```
Line2: Service 2 stopped
Line4: Service 2 was restarted #problem from Line 2 closed
```

To do this you need to tag these related events as, for example, "Service 1" and "Service 2". That can be done by applying a regular expression to the log line to extract the tag value. Then, when events are created, they are tagged "Service 1" and "Service 2" respectively and problem can be matched to the resolution.

Configuration

Item

To begin with, you may want to set up an item that monitors a log file, for example:

```
log[/var/log/syslog]
```

Item	Tags	Preprocessing
* Name	Syslog	
Type	Zabbix agent (active) ▾	
* Key	log[/var/log/syslog]	
Type of information	Text ▾	
* Update interval	30s	

With the item set up, wait a minute for the configuration changes to be picked up and then go to **Latest data** to make sure that the item has started collecting data.

Trigger

With the item working you need to configure the **trigger**. It's important to decide what entries in the log file are worth paying attention to. For example, the following trigger expression will search for a string like 'Stopping' to signal potential problems:

```
find(/My host/log[/var/log/syslog],,"regexp","Stopping")=1
```

Attention:

To make sure that each line containing the string "Stopping" is considered a problem also set the *Problem event generation mode* in trigger configuration to 'Multiple'.

Then define a recovery expression. The following recovery expression will resolve all problems if a log line is found containing the string "Starting":

```
find(/My host/log[/var/log/syslog],, "regex", "Starting")=1
```

Since we do not want that it's important to make sure somehow that the corresponding root problems are closed, not just all problems. That's where tagging can help.

Problems and resolutions can be matched by specifying a tag in the trigger configuration. The following settings have to be made:

- *Problem event generation mode*: Multiple
- *OK event closes*: All problems if tag values match
- Enter the name of the tag for event matching

New trigger

Trigger **Tags** Dependencies

* Name

Event name

Operational data

Severity

* Problem expression
[Expression constructor](#)

OK event generation

* Recovery expression
[Expression constructor](#)

PROBLEM event generation mode

OK event closes

* Tag for matching

- configure the **tags** to extract tag values from log lines

New trigger

Trigger **Tags 2** Dependencies

Tags	Name	Value
	<input type="text" value="scope"/>	<input type="text" value="availability"/>
	<input type="text" value="service"/>	<input "\1")}"="" ^[a-za-z0-9_+].service.*\$",="" type="text" value="{{ITEM.VALUE}.regsub("/>

If configured successfully you will be able to see problem events tagged by application and matched to their resolution in *Monitoring* → *Problems*.

Problems ? Export to CSV

<input type="checkbox"/>	Time	Severity	Recovery time	Status	Info	Host	Problem	Duration	Update	Actions	Tags
<input type="checkbox"/>	07:11:46 PM	High	07:15:16 PM	RESOLVED		My host	Service snmpd stopped	3m 30s	Update		scope: availability service: snmpd
<input type="checkbox"/>	07:11:45 PM	High	07:15:15 PM	RESOLVED		My host	Service apache2 stopped	3m 30s	Update		scope: availability service: apache2

Warning:

Because misconfiguration is possible, when similar event tags may be created for **unrelated** problems, please review the cases outlined below!

- With two applications writing error and recovery messages to the same log file a user may decide to use two *service* tags in the same trigger with different tag values by using separate regular expressions in the tag values to extract the names of, say, service A and service B from the {ITEM.VALUE} macro (e.g. when the message formats differ). However, this may not work as planned if there is no match to the regular expressions. Non-matching regexps will yield empty tag values and a single empty tag value in both problem and OK events is enough to correlate them. So a recovery message from service A may accidentally close an error message from service B.
- Actual tags and tag values only become visible when a trigger fires. If the regular expression used is invalid, it is silently replaced with an *UNKNOWN* string. If the initial problem event with an *UNKNOWN* tag value is missed, there may appear subsequent OK events with the same *UNKNOWN* tag value that may close problem events which they shouldn't have closed.
- If a user uses the {ITEM.VALUE} macro without macro functions as the tag value, the 255-character limitation applies. When log messages are long and the first 255 characters are non-specific, this may also result in similar event tags for unrelated problems.

2 Global event correlation

Overview

Global event correlation allows to reach out over all metrics monitored by Zabbix and create correlations.

It is possible to correlate events created by completely different triggers and apply the same operations to them all. By creating intelligent correlation rules it is actually possible to save yourself from thousands of repetitive notifications and focus on root causes of a problem!

Global event correlation is a powerful mechanism, which allows you to untie yourself from one-trigger based problem and resolution logic. So far, a single problem event was created by one trigger and we were dependent on that same trigger for the problem resolution. We could not resolve a problem created by one trigger with another trigger. But with event correlation based on event tagging, we can.

For example, a log trigger may report application problems, while a polling trigger may report the application to be up and running. Taking advantage of event tags you can tag the log trigger as *status:down* while tag the polling trigger as *status:up*. Then, in a global correlation rule you can relate these triggers and assign an appropriate operation to this correlation such as closing the old events.

In another use, global correlation can identify similar triggers and apply the same operation to them. What if we could get only one problem report per network port problem? No need to report them all. That is also possible with global event correlation.

Global event correlation is configured in **correlation rules**. A correlation rule defines how the new problem events are paired with existing problem events and what to do in case of a match (close the new event, close matched old events by generating corresponding OK events). If a problem is closed by global correlation, it is reported in the *Info* column of *Monitoring* → *Problems*.

Configuring global correlation rules is available to Super Admin level users only.

Attention:

Event correlation must be configured very carefully, as it can negatively affect event processing performance or, if mis-configured, close more events than was intended (in the worst case even all problem events could be closed).

To configure global correlation **safely**, observe the following important tips:

- Reduce the correlation scope. Always set a unique tag for the new event that is paired with old events and use the *New event tag* correlation condition;
- Add a condition based on the old event when using the *Close old event* operation (or else all existing problems could be closed);
- Avoid using common tag names that may end up being used by different correlation configurations;

- Keep the number of correlation rules limited to the ones you really need.

See also: [known issues](#).

Configuration

To configure event correlation rules globally:

- Go to *Data collection* → *Event correlation*
- Click on *Create event correlation* to the right (or on the correlation name to edit an existing rule)
- Enter parameters of the correlation rule in the form

New event correlation ? X

* Name

Type of calculation A and (B and C) and D

* Conditions

Label	Name	Action
A	Value of old event tag <i>application</i> equals value of new event tag <i>ap plication</i>	Remove
B	Value of old event tag <i>application</i> equals <i>abc</i>	Remove
C	Value of old event tag <i>status</i> equals <i>down</i>	Remove
D	Value of new event tag <i>status</i> equals <i>up</i>	Remove
Add		

Description

Operations Close old events
 Close new event

* At least one operation must be selected.

Enabled

All mandatory input fields are marked with a red asterisk.

Parameter	Description
<i>Name</i>	Unique correlation rule name.
<i>Type of calculation</i>	The following options of calculating conditions are available: And - all conditions must be met Or - enough if one condition is met And/Or - AND with different condition types and OR with the same condition type Custom expression - a user-defined calculation formula for evaluating action conditions. It must include all conditions (represented as uppercase letters A, B, C, ...) and may include spaces, tabs, brackets (), and (case sensitive), or (case sensitive), not (case sensitive).
<i>Conditions</i>	List of conditions. See below for details on configuring a condition.
<i>Description</i>	Correlation rule description.
<i>Operations</i>	Mark the checkbox of the operation to perform when event is correlated. The following operations are available: Close old events - close old events when a new event happens. Always add a condition based on the old event when using the <i>Close old events</i> operation or all existing problems could be closed. Close new event - close the new event when it happens
<i>Enabled</i>	If you mark this checkbox, the correlation rule will be enabled.

To configure details of a new condition, click on [Add](#) in the Conditions block. A popup window will open where you can edit the condition details.

New condition ✕

Type

* Tag

Operator equals does not equal contains does not contain

Value

Parameter	Description
<i>New condition</i>	<p>Select a condition for correlating events.</p> <p><i>Note</i> that if no old event condition is specified, all old events may be matched and closed. Similarly if no new event condition is specified, all new events may be matched and closed. The following conditions are available:</p> <p>Old event tag - specify the old event tag for matching.</p> <p>New event tag - specify the new event tag for matching.</p> <p>New event host group - specify the new event host group for matching.</p> <p>Event tag pair - specify new event tag and old event tag for matching. In this case there will be a match if the values of the tags in both events match. Tag <i>names</i> need not match. This option is useful for matching runtime values, which may not be known at the time of configuration (see also Example 1).</p> <p>Old event tag value - specify the old event tag name and value for matching, using the following operators:</p> <p><i>equals</i> - has the old event tag value</p> <p><i>does not equal</i> - does not have the old event tag value</p> <p><i>contains</i> - has the string in the old event tag value</p> <p><i>does not contain</i> - does not have the string in the old event tag value</p> <p>New event tag value - specify the new event tag name and value for matching, using the following operators:</p> <p><i>equals</i> - has the new event tag value</p> <p><i>does not equal</i> - does not have the new event tag value</p> <p><i>contains</i> - has the string in the new event tag value</p> <p><i>does not contain</i> - does not have the string in the new event tag value</p>

Warning:

Because misconfiguration is possible, when similar event tags may be created for **unrelated** problems, please review the cases outlined below!

- Actual tags and tag values only become visible when a trigger fires. If the regular expression used is invalid, it is silently replaced with an *UNKNOWN* string. If the initial problem event with an *UNKNOWN* tag value is missed, there may appear subsequent OK events with the same *UNKNOWN* tag value that may close problem events which they shouldn't have closed.
- If a user uses the {ITEM.VALUE} macro without macro functions as the tag value, the 255-character limitation applies. When log messages are long and the first 255 characters are non-specific, this may also result in similar event tags for unrelated problems.

Example

Stop repetitive problem events from the same network port.

New event correlation ? X

* Name

Type of calculation A and B

* Conditions

Label	Name	Action
A	Value of old event tag <i>port</i> equals value of new event tag <i>port</i>	Remove
B	Value of old event tag <i>host</i> equals value of new event tag <i>host</i>	Remove
Add		

Description

Operations Close old events
 Close new event

* At least one operation must be selected.

Enabled

This global correlation rule will correlate problems if *host* and *port* tag values exist on the trigger and they are the same in the original event and the new one.

The operation will close new problem events on the same network port, keeping only the original problem open.

6 Tagging

Overview

Tags consist of a tag name and a tag value. When tagging entities, you can use just the name or pair it with a value (for example, `mysql`, `jira`, `target:mysql`, `service:jira`, etc.).

Tags can be defined for various entities:

- Templates
- Hosts
- Items
- Web scenarios
- Triggers
- Services
- Template items and triggers
- Host, item, and trigger prototypes

Note:

Refer to the official Zabbix guidelines for [general recommendations](#) on defining tags, along with specific guidance for [templates](#), [items](#), [triggers](#), and [low-level discovery rules](#).

Tags have multiple purposes, most notably, to mark **events**. When entities are tagged, any new event related to a tagged entity will inherit its tags. For example:

- with tagged templates - any host problem (created by triggers from the template) will inherit the template tags;
- with tagged hosts - any host problem will inherit the host tags;
- with tagged items/web scenarios - any item/web scenario problem will inherit the item/web scenario tags;
- with tagged triggers - any problem created by the trigger will inherit the trigger tags.

A problem event inherits all tags from the whole chain of entities - templates, hosts, items/web scenarios, triggers. Identical `tag:value` combinations (after resolved macros) are merged into one, thus avoiding duplication.

Custom event tags offer more flexibility. For example:

- **event correlation** can be configured based on event tags;
- **action conditions** can be configured based on event tags;

- item problems can be grouped based on event tags;
- problem tags can be used to map problems to **services**.

Entities may be tagged with the same tag name but different tag values (for example, `component:memory` and `component:storage`). Similarly, an entity can have a tag without a value and the same tag with a value (for example, `database` and `database:postgresql`). Such tags are not considered duplicates.

Use cases

Some common use cases for tagging are as follows:

1. Mark trigger events:
 - Define a trigger tag (for example, `scope:performance`).
 - Problems created by this trigger will have the trigger tag.
2. Mark template-inherited problems:
 - Define a template tag (for example, `target:mysql`).
 - Problems created by triggers from this template will have the template tag.
3. Mark host problems:
 - Define a host tag (for example, `service:jira`).
 - Problems created by triggers from this host will have the host tag.
4. Filter related items:
 - Define an item tag (for example, `component:cpu`).
 - In *Monitoring* → *Latest data*, items can be filtered by the `component:cpu` tag.
5. Use information extracted from the item value as the tag value:
 - Define a tag with a macro as the tag value (for example, `tag-name:{{ITEM.VALUE<N>}.regsub() }`).
 - In *Monitoring* → *Problems*, problems will have the tag value resolved to the data extracted from the item value.
6. Identify problems in a log file and close them separately:
 - Define a trigger tag for the **log monitoring item** trigger that will extract values from the item value using a macro (for example, `service:{{ITEM.VALUE<N>}.regsub() }`).
 - In the **trigger configuration**, set up **event correlation**:
 - set *PROBLEM event generation mode* to "Multiple";
 - set *OK event closes* to "All problems if tag values match";
 - set the tag for matching.
 - Problems created by the log item trigger will have the trigger tag and will be closed individually.
7. Filter notifications:
 - Define trigger tags (for example, `scope:security` for `trigger1` and `scope:availability` for `trigger2`).
 - Use tag filtering in **action conditions** to receive notifications only on the events that match tag data.
8. Identify problems in notifications:
 - Define trigger tags.
 - Use the `{EVENT.TAGS}` macro in the problem notification.
 - The problem notification will contain the trigger tags, making it easier to identify which application/service the notification belongs to.
9. Simplify configuration tasks by using template tags:
 - Define a template trigger tag.
 - Triggers created from this template trigger will have its tag.
10. Create triggers with tags from low-level discovery (LLD):
 - Define a trigger prototype tag with an LLD macro in the tag name or value (for example, `scope:#{FSNAME}`).
 - Triggers created from the trigger prototype will have its tag.
11. Match services using service tags:
 - Define **service tags**.
 - Configure **service actions** for services with matching tags.
 - Additionally, use service tags to link a service to an **SLA** for SLA calculations.
12. Link services to problems using service problem tags:
 - Define a **problem tag** in **service configuration** (for example, `target:mysql`).
 - Problems with a matching tag will be automatically correlated to the service, and service status will change based on the configured service status calculation rules.
13. Suppress problems when a host is in maintenance mode:
 - Define tags in **maintenance period configuration**.
 - Problems with the defined tags will be suppressed.
14. Grant access to user groups:
 - Define tags in **user group configuration**.
 - Users in the user group will be able to view only problems with the defined tags.

Configuration

Tags can be defined in a dedicated tab, for example, in **trigger configuration**:

New trigger

Trigger Tags 4 Dependencies

Trigger tags Inherited and trigger tags

Tags	Name	Value
	scope	capacity
	scope	performance
	customer	value
	host	{{ITEM.VALUE2}.iregsub(pattern, output)}

Macro support

Built-in and **user macros** in tags are resolved at the time of the event. Until the event has occurred, these macros will be shown in Zabbix frontend unresolved.

Low-level discovery macros are resolved during discovery process.

The following macros may be used in trigger tag names and values:

- {ITEM.VALUE}, {ITEM.LASTVALUE}, {HOST.HOST}, {HOST.NAME}, {HOST.CONN}, {HOST.DNS}, {HOST.IP}, {HOST.PORT}, and {HOST.ID} built-in macros
- {INVENTORY.*} built-in macros (for referencing host inventory values from one or several hosts in a trigger expression)
- User macros and user macros with context (the context may include low-level discovery macros)
- Low-level discovery macros (only in trigger prototype tags)

The following macros may be used in template, host, and item/web scenario tag names and values:

- {HOST.HOST}, {HOST.NAME}, {HOST.CONN}, {HOST.DNS}, {HOST.IP}, {HOST.PORT} and {HOST.ID} built-in macros
- {INVENTORY.*} built-in macros
- User macros
- Low-level discovery macros (only in host and item prototype tags)

The following macros may be used in trigger-based notifications:

- {EVENT.TAGS} and {EVENT.RECOVERY.TAGS} built-in macros (these macros will resolve to a comma-separated list of event tags or recovery event tags)
- {EVENT.TAGSJSON} and {EVENT.RECOVERY.TAGSJSON} built-in macros (these macros will resolve to a JSON array containing event tag **objects** or recovery event tag objects)

Substring extraction in trigger tags

Substring extraction is supported for populating the tag name or tag value, using a macro **function**. The function applies a regular expression to the value obtained by the **supported** macro. For example:

```
{{ITEM.VALUE}.regsub(pattern, output)}  
{{ITEM.VALUE}.iregsub(pattern, output)}
```

```
{{#LLDMACRO}.regsub(pattern, output)}  
{{#LLDMACRO}.iregsub(pattern, output)}
```

If the tag name or value exceeds 255 characters after macro resolution, it will be truncated to 255 characters.

See also: Using macro functions in **low-level discovery macros** for event tagging.

Viewing event tags

Tags, if defined, can be viewed with new events in:

- *Monitoring* → *Problems*
- *Monitoring* → *Problems* → *Event details*
- *Dashboards* → *Problems widget*

The order and number of displayed tags is determined by the *Tag display priority* and *Show tags* filtering options in *Monitoring* → *Problems* or the *Problems* dashboard widget. Note that a maximum of three tags can be displayed; if there are more tags, hovering over the three dots reveals all tags in a pop-up window.

Status Info Host Problem Duration Update Actions Tags

PROBLEM zbx-vm05 ↑ Load average is too high (per CPU load over 1.5 for 5m) 30s Update customer target: linux component: cpu

class: os component: cpu customer scope: capacity scope: performance target: linux

7 Visualization

1 Graphs

Overview

With lots of data flowing into Zabbix, it becomes much easier for the users if they can look at a visual representation of what is going on rather than only numbers.

This is where graphs come in. Graphs allow to grasp the data flow at a glance, correlate problems, discover when something started or make a presentation of when something might turn into a problem.

Zabbix provides users with:

- built-in **simple graphs** of one item data
- the possibility to create more complex **customized graphs**
- access to a comparison of several items quickly in **ad-hoc graphs**
- modern customizable vector **graphs** and **pie charts**

1 Simple graphs

Overview

Simple graphs are provided for the visualization of data gathered by items.

No configuration effort is required on the user part to view simple graphs. They are freely made available by Zabbix.

Just go to *Monitoring* → *Latest data* and click on the Graph link for the respective item and a graph will be displayed.

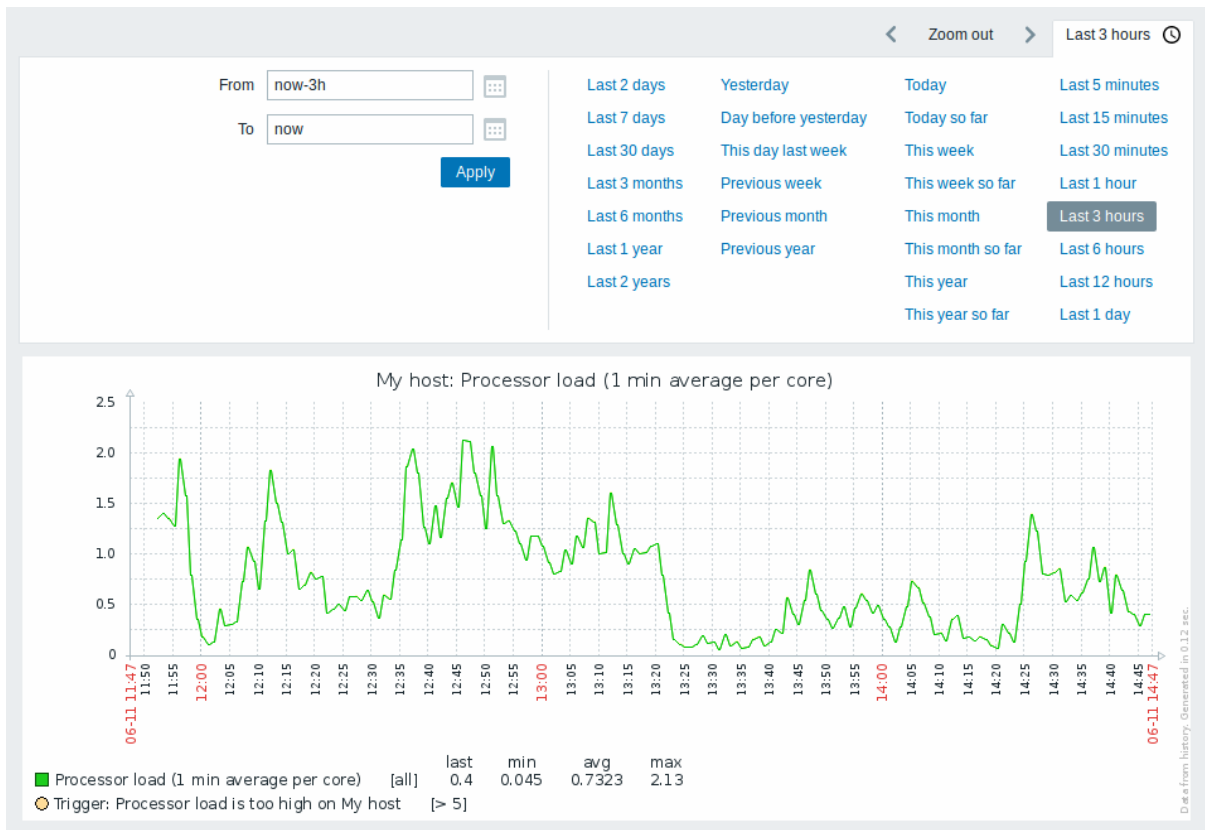

Note:

Simple graphs are provided for all numeric items. For textual items, a link to History is available in *Monitoring* → *Latest data*.

Time period selector

The *Time period* selector above the graph allows to select often required periods with one mouse click. For more information, see *Time period selector*.

Recent data vs longer periods

For very recent data a **single** line is drawn connecting each received value. The single line is drawn as long as there is at least one horizontal pixel available for one value.

For data that show a longer period **three lines** are drawn - a dark green one shows the average, while a light pink and a light green line shows the maximum and minimum values at that point in time. The space between the highs and the lows is filled with yellow background.

Working time (working days) is displayed in graphs as a white background, while non-working time is displayed in gray (with the *Original blue* default frontend theme).

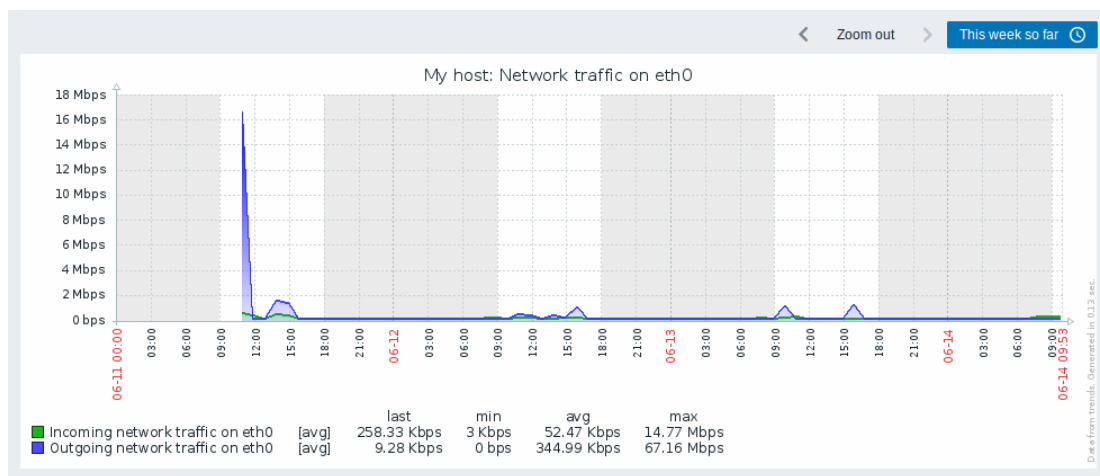

Working time is always displayed in simple graphs, whereas displaying it in **custom graphs** is a user preference.

Working time is not displayed if the graph shows more than 3 months.

Trigger lines

Simple triggers are displayed as lines with black dashes over trigger severity color -- take note of the blue line on the graph and the trigger information displayed in the legend. Up to 3 trigger lines can be displayed on the graph; if there are more triggers then the triggers with lower severity are prioritized. Triggers are always displayed in simple graphs, whereas displaying them in **custom graphs** is a user preference.

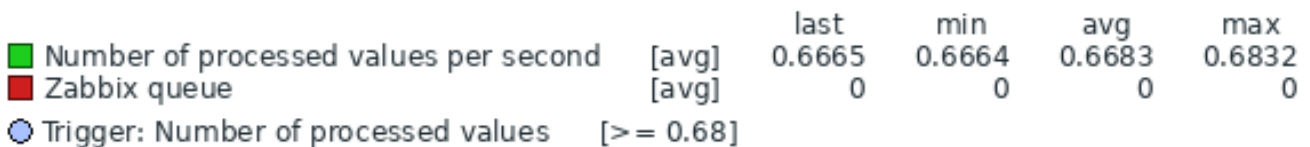

Generating from history/trends

Graphs can be drawn based on either item [history](#) or [trends](#).

For the users who have frontend [debug mode](#) activated, a gray, vertical caption is displayed at the bottom right of a graph indicating where the data come from.

Several factors influence whether history or trends is used:

- longevity of item history. For example, item history can be kept for 14 days. In that case, any data older than the fourteen days will be coming from trends.
- data congestion in the graph. If the amount of seconds to display in a horizontal graph pixel exceeds 3600/16, trend data are displayed (even if item history is still available for the same period).
- if trends are disabled, item history is used for graph building - if available for that period.

Absence of data

For items with a regular update interval, nothing is displayed in the graph if item data are not collected.

However, for trapper items and items with a scheduled update interval (and regular update interval set to 0), a straight line is drawn leading up to the first collected value and from the last collected value to the end of graph; the line is on the level of the first/last value respectively.

Switching to raw values

A dropdown on the upper right allows to switch from the simple graph to the *Values/500 latest values* listings. This can be useful for viewing the numeric values making up the graph.

The values represented here are raw, i.e. no units or postprocessing of values is used. Value mapping, however, is applied.

Known issues

See [known issues](#) for graphs.

2 Custom graphs

Overview

Custom graphs, as the name suggests, offer customization capabilities.

While simple graphs are good for viewing data of a single item, they do not offer configuration capabilities.

Thus, if you want to change graph style or the way lines are displayed or compare several items, for example, incoming and outgoing traffic in a single graph, you need a custom graph.

Custom graphs are configured manually.

They can be created for a host or several hosts or for a single template.

Configuring custom graphs

To create a custom graph, do the following:

- Go to *Data collection* → *Hosts (or Templates)*
- Click on *Graphs* in the row next to the desired host or template
- In the Graphs screen click on *Create graph*
- Edit graph attributes

All mandatory input fields are marked with a red asterisk.

Graph attributes:

Parameter	Description
<i>Name</i>	Unique graph name. Expression macros are supported in this field, but only with avg, last, min and max functions, with time as parameter (for example, <code>{?avg(/host/key, 1h)}</code>). <code>{HOST.HOST<1-9>}</code> macros are supported for the use within this macro, referencing the first, second, third, etc. host in the graph, for example <code>{?avg(/{HOST.HOST2}/key, 1h)}</code> . Note that referencing the first host with this macro is redundant, as the first host can be referenced implicitly, for example <code>{?avg(/key, 1h)}</code> .
<i>Width</i>	Graph width in pixels (for preview and pie/exploded graphs only).
<i>Height</i>	Graph height in pixels.
<i>Graph type</i>	Graph type: Normal - normal graph, values displayed as lines Stacked - stacked graph, filled areas displayed Pie - pie graph Exploded - "exploded" pie graph, portions displayed as "cut out" of the pie
<i>Show legend</i>	Checking this box will set to display the graph legend.

Parameter	Description
<i>Show working time</i>	If selected, non-working hours will be shown with a gray background. This parameter is not available for pie and exploded pie graphs.
<i>Show triggers</i>	If selected, simple triggers will be displayed as lines with black dashes over trigger severity color. This parameter is not available for pie and exploded pie graphs.
<i>Percentile line (left)</i>	Display percentile for left Y-axis. If, for example, 95% percentile is set, then the percentile line will be at the level where 95 percent of the values fall under. Displayed as a bright green line. Only available for normal graphs.
<i>Percentile line (right)</i>	Display percentile for right Y-axis. If, for example, 95% percentile is set, then the percentile line will be at the level where 95 percent of the values fall under. Displayed as a bright red line. Only available for normal graphs.
<i>Y axis MIN value</i>	Minimum value of Y-axis: Calculated - Y axis minimum value will be automatically calculated. Fixed - fixed minimum value for Y-axis. Item - last value of the selected item will be the minimum value.
<i>Y axis MAX value</i>	This parameter is not available for pie and exploded pie graphs. Maximum value of Y-axis: Calculated - Y axis maximum value will be automatically calculated. Fixed - fixed maximum value for Y-axis. Item - last value of the selected item will be the maximum value
<i>3D view Items</i>	This parameter is not available for pie and exploded pie graphs. Enable 3D style. For pie and exploded pie graphs only.
<i>Sort order (0→100)</i>	Items, data of which are to be displayed in this graph. Click on <i>Add</i> to select items. You can also select various displaying options (function, draw style, left/right axis display, color). Draw order. 0 will be processed first. Can be used to draw lines or regions behind (or in front of) another. You can drag and drop items using the icon at the beginning of a line to set the sort order or which item is displayed in front of the other.
<i>Name</i>	Name of the selected item is displayed as a link. Clicking on the link opens the list of other available items.
<i>Type</i>	Type (only available for pie and exploded pie graphs): Simple - the value of the item is represented proportionally on the pie Graph sum - the value of the item represents the whole pie Note that coloring of the "graph sum" item will only be visible to the extent that it is not taken up by "proportional" items.
<i>Function</i>	Select what values will be displayed when more than one value exists per vertical graph pixel for an item: all - display all possible values (minimum, maximum, average) in the graph. Note that for shorter periods this setting has no effect; only for longer periods, when data congestion in a vertical graph pixel increases, 'all' starts displaying minimum, maximum, and average values. This function is only available for <i>Normal</i> graph type. See also: Generating graphs from history/trends . avg - display the average values last - display the latest values. This function is only available if either <i>Pie/Exploded pie</i> is selected as graph type. max - display the maximum values min - display the minimum values
<i>Draw style</i>	Select the draw style (only available for normal graphs; for stacked graphs filled region is always used) to apply to the item data - <i>Line, Bold line, Filled region, Dot, Dashed line, Gradient line</i> .
<i>Y axis side Color</i>	Select the Y axis side to show the item data - <i>Left, Right</i> . Select the color to apply to the item data.

Graph preview

In the *Preview* tab, a preview of the graph is displayed so you can immediately see what you are creating.

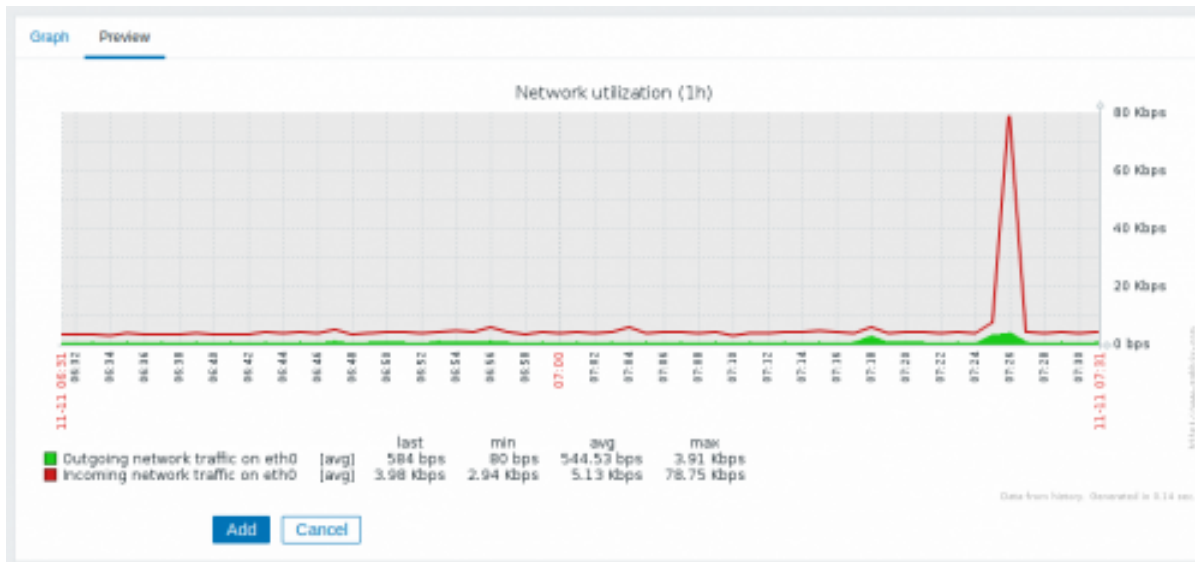

Note that the preview will not show any data for template items.



In this example, pay attention to the dashed bold line displaying the trigger level and the trigger information displayed in the legend.

Note:

No more than 3 trigger lines can be displayed. If there are more triggers then the triggers with lower severity are prioritized for display.

If graph height is set as less than 120 pixels, no trigger will be displayed in the legend.

3 Ad-hoc graphs

Overview

While a **simple graph** is great for accessing data of one item and **custom graphs** offer customization options, none of the two allow to quickly create a comparison graph for multiple items with little effort and no maintenance.

To address this issue, it is possible to create ad-hoc graphs for several items in a very quick way.

Configuration

To create an ad-hoc graph, do the following:

- Go to *Monitoring* → *Latest data*
- Use filter to display items that you want
- Mark checkboxes of the items you want to graph

- Click on *Display stacked graph* or *Display graph* buttons

Latest data

<input type="checkbox"/> Host ▲	Name	Last check	Last value
<input checked="" type="checkbox"/> New host	CPU load average	05/24/2021 10:46:5...	0.86
<input type="checkbox"/> Zabbix server	Load average (1m avg)	05/24/2021 10:47:1...	0.73
<input type="checkbox"/> Zabbix server	Load average (15m avg)	05/24/2021 10:47:1...	0.93
<input checked="" type="checkbox"/> Zabbix server	Load average (5m avg)	05/24/2021 10:47:1...	0.93

2 selected Display stacked graph Display graph

Your graph is created instantly:

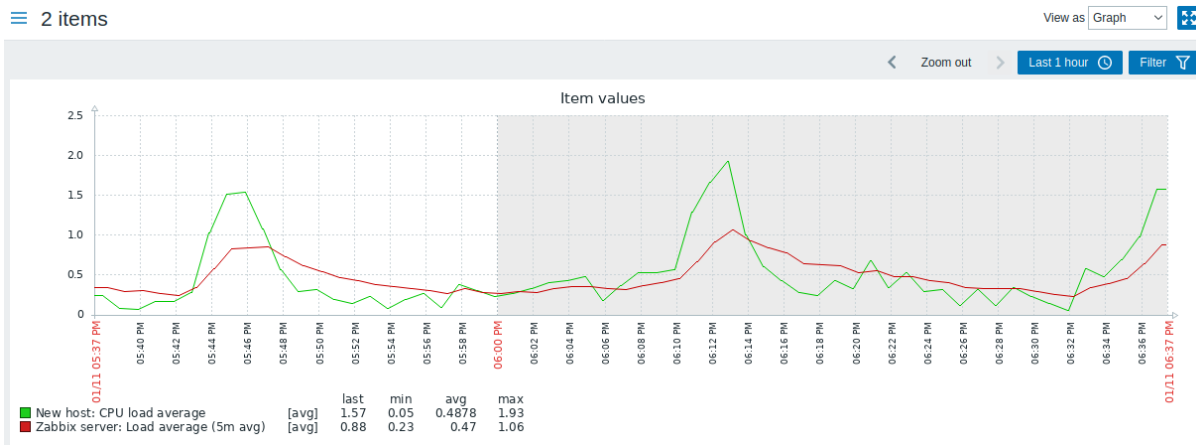

Note that to avoid displaying too many lines in the graph, only the average value for each item is displayed (min/max value lines are not displayed). Triggers and trigger information is not displayed in the graph.

In the created graph window you have the *Time period selector* available and the possibility to switch from the "normal" line graph to a stacked one (and back).

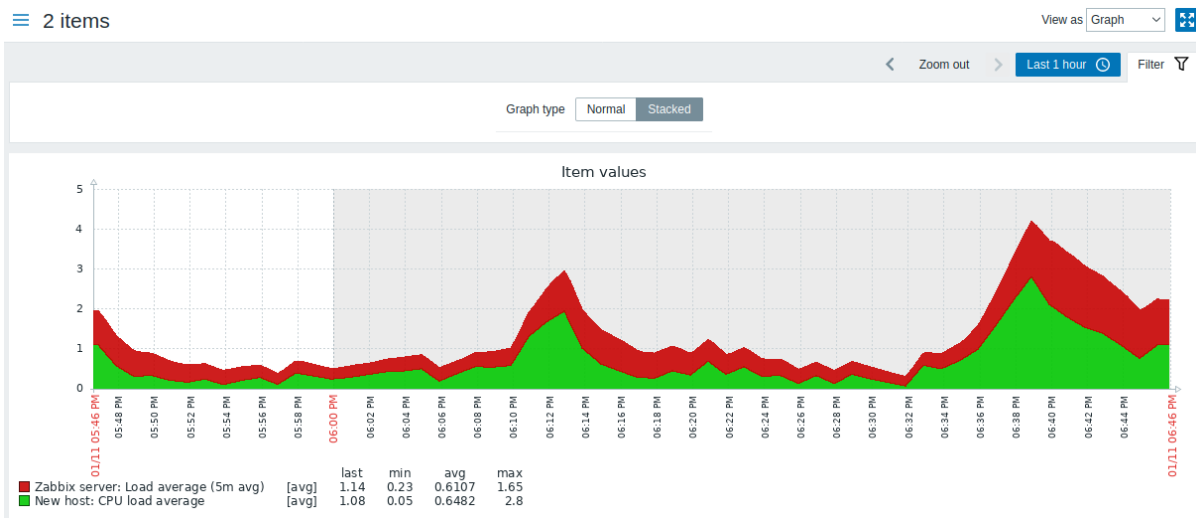

4 Aggregation in graphs

Overview

Aggregation functions, available in the graph and pie chart widgets of the dashboard, allow displaying an aggregated value for the chosen interval (5 minutes, an hour, a day), instead of all values.

This section provides more detail on aggregation options in the graph widget.

The aggregation options are as follows:

- min
- max
- avg
- count
- sum
- first (first value displayed)
- last (last value displayed)

The most exciting use of data aggregation is the possibility to create nice side-by-side comparisons of data for some period:

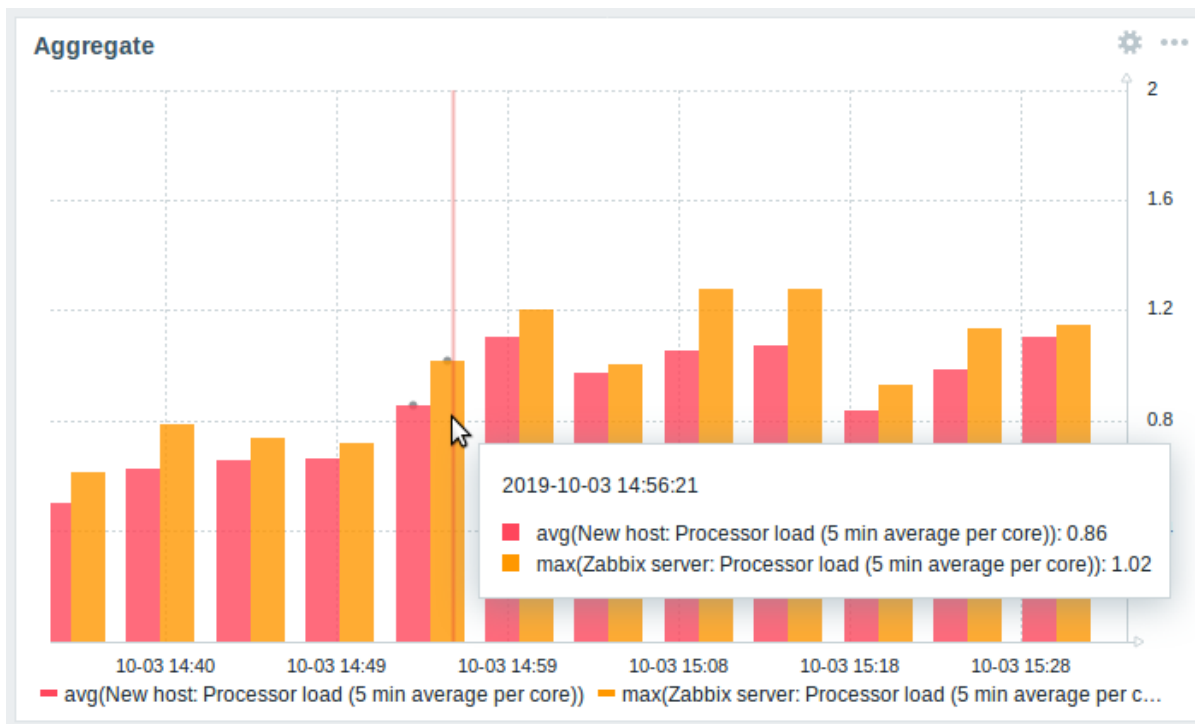

When hovering over a point in time in the graph, date and time is displayed in addition to items and their aggregated values. Items are displayed in parentheses, prefixed by the aggregation function used. If the graph widget has a *Data set label* configured, the label is displayed in parentheses, prefixed by the aggregation function used. Note that this is the date and time of the point in the graph, not of the actual values.

Configuration

The options for aggregation are available in data set settings when configuring a *graph widget*.

Y-axis Left Right

Time shift

Aggregation function

Aggregation interval

Aggregate Each item Data set

Approximation

Data set label

You may pick the aggregation function and the time interval. As the data set may comprise several items, there is also another option allowing to show aggregated data for each item separately or for all data set items as one aggregated value.

Use cases

Average request count to Nginx server

View the average request count per second per day to the Nginx server:

- add the request count per second item to the data set
- select the aggregate function `avg` and specify interval `1d`
- a bar graph is displayed, where each bar represents the average number of requests per second per day

Minimum weekly disk space among clusters

View the lowest disk space among clusters over a week.

- add to the data set: hosts `cluster*`, key "Free disk space on /data"
- select the aggregate function `min` and specify interval `1w`
- a bar graph is displayed, where each bar represents the minimum disk space per week for each /data volume of the cluster

2 Network maps

Overview

If you have a network to look after, you may want to have an overview of your infrastructure somewhere. For that purpose, you can create maps in Zabbix - of networks and of anything you like.

All users can create network maps. The maps can be public (available to all users) or private (available to selected users).

Proceed to [configuring a network map](#).

1 Configuring a network map

Overview

Configuring a map in Zabbix requires that you first create a map by defining its general parameters and then you start filling the actual map with elements and their links.

You can populate the map with elements that are a host, a host group, a trigger, an image, or another map.

Icons are used to represent map elements. You can define the information that will be displayed with the icons and set that recent problems are displayed in a special way. You can link the icons and define information to be displayed on the links.

You can add custom URLs to be accessible by clicking on the icons. Thus you may link a host icon to host properties or a map icon to another map.

The problem count in maps is displayed for cause problems only.

Maps are managed in *Monitoring* → *Maps*, where they can be configured, managed and viewed. In the monitoring view, you can click on the icons and take advantage of the links to some scripts and URLs.

Network maps are based on vector graphics (SVG).

Public and private maps

All users in Zabbix (including non-admin users) can create network maps. Maps have an owner - the user who created them. Maps can be made public or private.

- *Public* maps are visible to all users, although to see it the user must have read access to at least one map element. Public maps can be edited in case a user/ user group has read-write permissions for this map and at least read permissions to all elements of the corresponding map including triggers in the links.
- *Private* maps are visible only to their owner and the users/user groups the map is *shared* with by the owner. Regular (non-Super admin) users can only share with the groups and users they are members of. Admin level users can see private maps regardless of being the owner or belonging to the shared user list. Private maps can be edited by the owner of the map and in case a user/ user group has read-write permissions for this map and at least read permissions to all elements of the corresponding map including triggers in the links.

Map elements that the user does not have read permission to are displayed with a grayed-out icon and all textual information on the element is hidden. However, the trigger label is visible even if the user has no permission to the trigger.

To add an element to the map the user must also have at least read permission to the element.

Creating a map

To create a map, do the following:

- Go to *Monitoring* → *Maps*
- Go to the view with all maps
- Click on *Create map*

You can also use the *Clone* button in the configuration form of an existing map to create a new map. This map will have all of the properties of the existing map, including general layout attributes, as well as the elements of the existing map.

The **Map** tab contains general map attributes:

Map **Sharing**

* Owner

* Name

* Width

* Height

Background image

Automatic icon mapping [show icon mappings](#)

Icon highlight

Mark elements on trigger status change

Display problems Expand single problem Number of problems Number of p

Advanced labels

Host group label type

Host label type

Trigger label type

Map label type

Image label type

Map element label location

Problem display

Minimum severity Not classified Information Warning Average High

Show suppressed problems

URLs

Name	URL
<input type="text" value="Latest data"/>	<input type="text" value="https://localhost/zabbix/latest.php"/>
Add	

All mandatory input fields are marked with a red asterisk.

General map attributes:

Parameter	Description
<i>Owner</i>	Name of map owner.
<i>Name</i>	Unique map name.
<i>Width</i>	Map width in pixels.
<i>Height</i>	Map height in pixels.
<i>Background image</i>	Use background image: No image - no background image (white background) Image - selected image to be used as a background image. No scaling is performed. You may use a geographical map or any other image to enhance your map.
<i>Automatic icon mapping</i>	You can set to use an automatic icon mapping, configured in <i>Administration</i> → <i>General</i> → <i>Icon mapping</i> . Icon mapping allows mapping certain icons against certain host inventory fields.
<i>Icon highlighting</i>	If you check this box, map elements will receive highlighting. Elements with an active trigger will receive a round background, in the same color as the highest severity trigger. Moreover, a thick green line will be displayed around the circle, if all problems are acknowledged. Elements with "disabled" or "in maintenance" status will get a square background, gray and orange respectively. See also: Viewing maps
<i>Mark elements on trigger status change</i>	A recent change of trigger status (recent problem or resolution) will be highlighted with markers (inward-pointing red triangles) on the three sides of the element icon that are free of the label. Markers are displayed for 30 minutes.
<i>Display problems</i>	Select how problems are displayed with a map element: Expand single problem - if there is only one problem, the problem name is displayed. Otherwise, the total number of problems is displayed. Number of problems - the total number of problems is displayed Number of problems and expand most critical one - the name of the most critical problem and the total number of problems is displayed. 'Most critical' is determined based on problem severity and, if equal, problem event ID (higher ID or later problem displayed first). For a <i>trigger map element</i> it is based on problem severity and if equal, trigger position in the trigger list. In case of multiple problems of the same trigger, the most recent one will be displayed.
<i>Advanced labels</i>	If you check this box you will be able to define separate label types for separate element types.
<i>Map element label type</i>	Label type used for map elements: Label - map element label IP address - IP address Element name - element name (for example, host name) Status only - status only (OK or PROBLEM) Nothing - no labels are displayed
<i>Map element label location</i>	Label location in relation to the map element: Bottom - beneath the map element Left - to the left Right - to the right Top - above the map element
<i>Problem display</i>	Display problem count as: All - full problem count will be displayed Separated - unacknowledged problem count will be displayed separated as a number of the total problem count Unacknowledged only - only the unacknowledged problem count will be displayed
<i>Minimum trigger severity</i>	Problems below the selected minimum severity level will not be displayed on the map. For example, with <i>Warning</i> selected, changes with <i>Information</i> and <i>Not classified</i> level triggers will not be reflected in the map.
<i>Show suppressed problems</i>	Mark the checkbox to display problems that would otherwise be suppressed (not shown) because of host maintenance.
<i>URLs</i>	URLs (up to 2048 characters) for each element type can be defined. A label for the URL can also be defined. These will be displayed as links when a user clicks on the element in the map viewing mode. Macros can be used in map URL names and values. For a full list, see supported macros and search for 'map URL names and values'.

Sharing

The **Sharing** tab contains the map type as well as sharing options (user groups, users) for private maps:

Map **Sharing** ●

Type Private Public

List of user group shares

User groups	Permissions
MySQL administrators	<input type="radio"/> Read-only <input checked="" type="radio"/> Read-write
Add	

List of user shares

Users	Permissions
Admin (Zabbix Administrator)	<input type="radio"/> Read-only <input checked="" type="radio"/> Read-write
Add	

Parameter	Description
<i>Type</i>	Select map type: Private - map is visible only to selected user groups and users Public - map is visible to all
<i>List of user group shares</i>	Select user groups that the map is accessible to. You may allow read-only or read-write access.
<i>List of user shares</i>	Select users that the map is accessible to. You may allow read-only or read-write access.

When you click on *Add* to save this map, you have created an empty map with a name, dimensions, and certain preferences. Now you need to add some elements. For that, click on *Edit* in the map list to open the editable area.

Adding elements

To add an element, click on *Add* next to Map element. The new element will appear at the top left corner of the map. Drag and drop it wherever you like.

Note that with the Grid option "On", elements will always align to the grid (you can pick various grid sizes from the dropdown, also hide/show the grid). If you want to put elements anywhere without alignment, turn the option to "Off". (You can align random elements to the grid later, by clicking on *Align map elements*.)

Now that you have some elements in place, you may want to start differentiating them by giving names, etc. By clicking on the element, a form is displayed and you can set the element type, give a name, choose a different icon, etc.

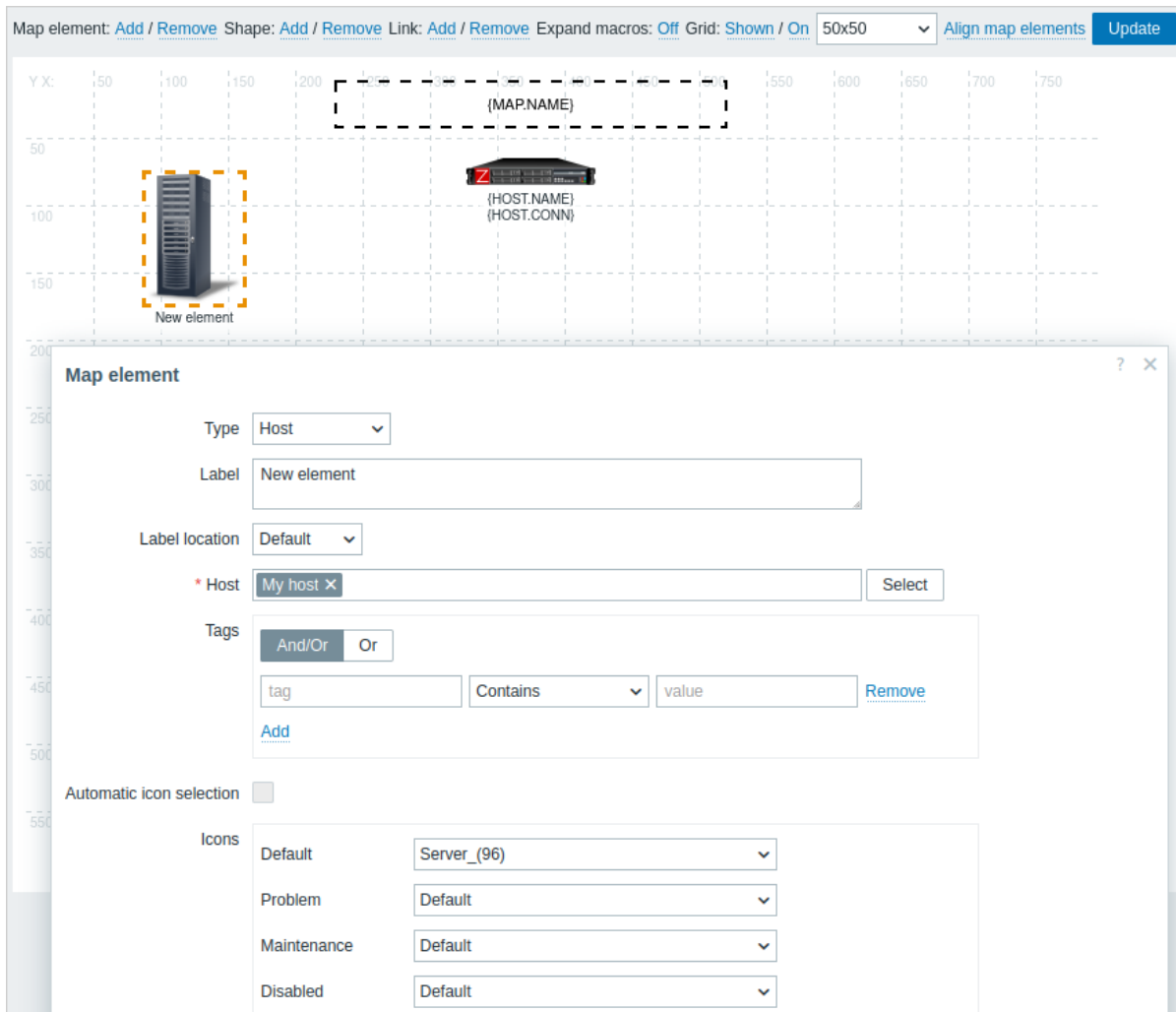

Map element attributes:

Parameter	Description
<i>Type</i>	Type of the element: Host - icon representing status of all triggers of the selected host Map - icon representing status of all elements of a map Trigger - icon representing status of one or more triggers Host group - icon representing status of all triggers of all hosts belonging to the selected group Image - an icon, not linked to any resource
<i>Label</i>	Icon label, any string. Macros and multiline strings can be used. Expression macros are supported in this field, but only with avg, last, min and max functions, with time as parameter (for example, {?avg(/host/key, 1h)}).
<i>Label location</i>	Label location in relation to the icon: Default - map's default label location Bottom - beneath the icon Left - to the left Right - to the right Top - above the icon
<i>Host</i>	Enter the host if the element type is 'Host'. This field is auto-complete so starting to type the name of a host will offer a dropdown of matching hosts. Scroll down to select. Click on 'x' to remove the selected.
<i>Map</i>	Select the map if the element type is 'Map'. This field is auto-complete so starting to type the name of a map will offer a dropdown of matching maps. Scroll down to select. Click on 'x' to remove the selected.

Parameter	Description
<i>Triggers</i>	<p>If the element type is 'Trigger', select one or more triggers in the <i>New triggers</i> field below and click on <i>Add</i>.</p> <p>The order of selected triggers can be changed, but only within the same severity of triggers. Multiple trigger selection also affects {HOST.*} macro resolution both in the editing and view modes.</p> <p>// 1 In editing mode// the first displayed {HOST.*} macros will be resolved depending on the first trigger in the list (based on trigger severity).</p> <p>// 2 View mode// depends on the Display problems parameter in General map attributes.</p> <p>* If <i>Expand single problem</i> mode is chosen, the first displayed {HOST.*} macros will be resolved depending on the latest detected problem trigger (not mattering the severity) or the first trigger in the list (in case no problem detected);</p> <p>* If <i>Number of problems and expand most critical one</i> mode is chosen, the first displayed {HOST.*} macros will be resolved depending on the trigger severity.</p>
<i>Host group</i>	<p>Enter the host group if the element type is 'Host group'. This field is auto-complete so starting to type the name of a group will offer a dropdown of matching groups. Scroll down to select. Click on 'x' to remove the selected.</p>
<i>Tags</i>	<p>Specify tags to limit the number of problems displayed in the widget. It is possible to include as well as exclude specific tags and tag values. Several conditions can be set. Tag name matching is always case-sensitive.</p> <p>There are several operators available for each condition:</p> <p>Exists - include the specified tag names</p> <p>Equals - include the specified tag names and values (case-sensitive)</p> <p>Contains - include the specified tag names where the tag values contain the entered string (substring match, case-insensitive)</p> <p>Does not exist - exclude the specified tag names</p> <p>Does not equal - exclude the specified tag names and values (case-sensitive)</p> <p>Does not contain - exclude the specified tag names where the tag values contain the entered string (substring match, case-insensitive)</p> <p>There are two calculation types for conditions:</p> <p>And/Or - all conditions must be met, conditions having the same tag name will be grouped by the Or condition</p> <p>Or - enough if one condition is met</p> <p>This field is available for host and host group element types.</p>
<i>Automatic icon selection</i>	<p>In this case an icon mapping will be used to determine which icon to display.</p>
<i>Icons</i>	<p>You can choose to display different icons for the element in these cases: default, problem, maintenance, disabled.</p>
<i>Coordinate X</i>	<p>X coordinate of the map element.</p>
<i>Coordinate Y</i>	<p>Y coordinate of the map element.</p>
<i>URLs</i>	<p>Element-specific URLs (up to 2048 characters) can be set for the element. A label for the URL can also be defined. These will be displayed as links when a user clicks on the element in the map viewing mode. If the element has its own URLs and there are map level URLs for its type defined, they will be combined in the same menu.</p> <p>Macros can be used in map element names and values. For a full list, see supported macros and search for 'map URL names and values'.</p>

Attention:

Added elements are not automatically saved. If you navigate away from the page, all changes may be lost. Therefore it is a good idea to click on the **Update** button in the top right corner. Once clicked, the changes are saved regardless of what you choose in the following popup. Selected grid options are also saved with each map.

Selecting elements

To select elements, select one and then hold down *Ctrl* to select the others.

You can also select multiple elements by dragging a rectangle in the editable area and selecting all elements in it.

Once you select more than one element, the element property form shifts to the mass-update mode so you can change attributes of selected elements in one go. To do so, mark the attribute using the checkbox and enter a new value for it. You may use macros here (for example, {HOST.NAME} for the element label).

Map element: [Add](#) / [Remove](#) Shape: [Add](#) / [Remove](#) Link: [Add](#) / [Remove](#) Expand macros: [Off](#) Grid: [Shown](#) / [On](#) 50x50 [Align map elements](#) [Update](#)

Y.X: 50 100 150 200 250 300 350 400 450 500 550

(MAP.NAME)

{HOST.NAME}
{HOST.CONN}

New element

Mass update elements

Selected elements

Type	Name
Host	My host
Host	vcenter.zabbix.lan

Label

Label location

Automatic icon selection

Icon (default)

Icon (problem)

Icon (maintenance)

Icon (disabled)

[Apply](#) [Remove](#) [Close](#)

Linking elements

Once you have put some elements on the map, it is time to start linking them. To link two elements you must first select them. With the elements selected, click on *Add* next to Link.

With a link created, the single element form now contains an additional *Links* section. Click on *Edit* to edit link attributes.

Map element: [Add / Remove](#) Shape: [Add / Remove](#) Link: [Add / Remove](#) Expand macros: [Off](#) Grid: [Shown / On](#) 50x50 [Align map elements](#) [Update](#)

Map element

Type:

Label:

Label location:

* Host: [Select](#)

Tags: [Remove](#)
[Add](#)

Automatic icon selection:

Icons:

- Default:
- Problem:
- Maintenance:
- Disabled:

Coordinates X: Y:

URLs:

Name	URL	Action
<input type="text"/>	<input type="text"/>	Remove

[Add](#)

[Apply](#) [Remove](#) [Close](#)

Links:

Element name	Link indicators	Action
vcenter.zabbix.lan		Edit

Label:

Connect to:

Type (OK):

Color (OK):

Link indicators:

Trigger	Type	Color	Action
Add			

[Apply](#) [Remove](#) [Close](#)

Link attributes:

Parameter	Description
<i>Label</i>	Label that will be rendered on top of the link. Expression macros are supported in this field, but only with <code>avg</code> , <code>last</code> , <code>min</code> and <code>max</code> functions, with time as parameter (for example, <code>{?avg(/host/key, 1h)}</code>).
<i>Connect to</i>	The element that the link connects to.

Parameter	Description
<i>Type (OK)</i>	Default link style: Line - single line Bold line - bold line Dot - dots Dashed line - dashed line
<i>Color (OK)</i>	Default link color.
<i>Link indicators</i>	List of triggers linked to the link. In case a trigger has status PROBLEM , its style is applied to the link.

Moving and copy-pasting elements

Several selected elements can be **moved** to another place in the map by clicking on one of the selected elements, holding down the mouse button, and moving the cursor to the desired location.

One or more elements can be **copied** by selecting the elements, then clicking on a selected element with the right mouse button and selecting *Copy* from the menu.

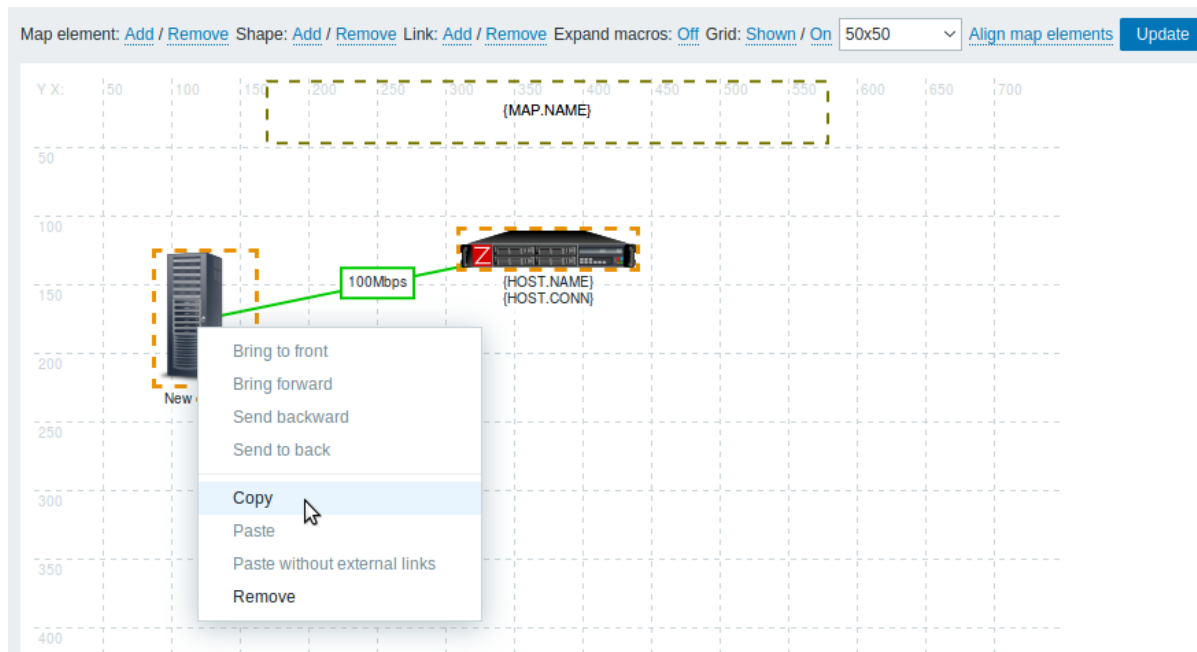

To paste the elements, click on a map area with the right mouse button and select *Paste* from the menu. The *Paste without external links* option will paste the elements retaining only the links that are between the selected elements.

Copy-pasting works within the same browser window. Keyboard shortcuts are not supported.

Adding shapes

In addition to map elements, it is also possible to add some shapes. Shapes are not map elements; they are just a visual representation. For example, a rectangle shape can be used as a background to group some hosts. Rectangle and ellipse shapes can be added.

To add a shape, click on *Add* next to Shape. The new shape will appear at the top left corner of the map. Drag and drop it wherever you like.

A new shape is added with default colors. By clicking on the shape, a form is displayed and you can customize the way a shape looks, add text, etc.

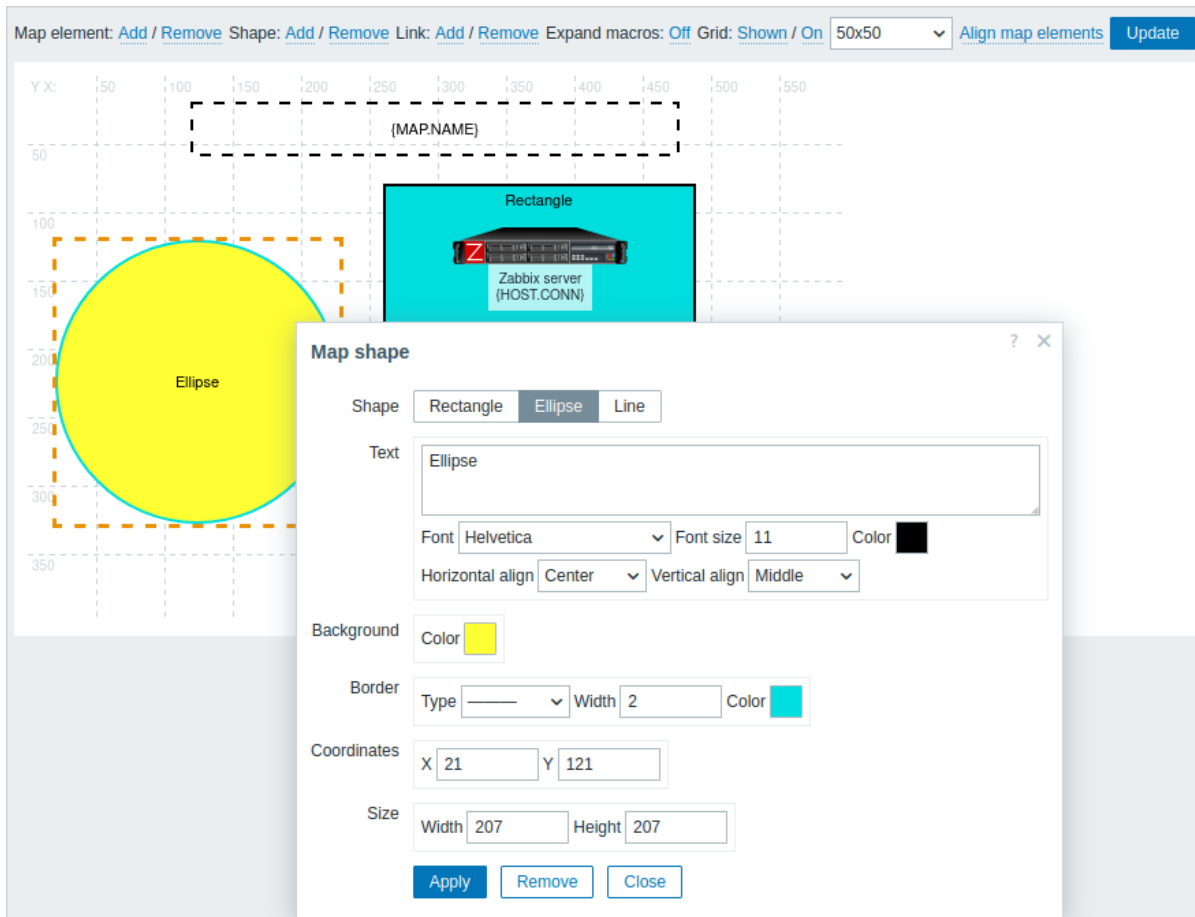

To select shapes, select one and then hold down *Ctrl* to select the others. With several shapes selected, common properties can be mass updated, similarly as with elements.

Text can be added in the shapes. Expression **macros** are supported in the text, but only with `avg`, `last`, `min` and `max` functions, with time as parameter (for example, `{?avg(/host/key,1h)}`).

To display text only, the shape can be made invisible by removing the shape border (select 'None' in the *Border* field). For example, take note of how the `{MAP.NAME}` macro, visible in the screenshot above, is actually a rectangle shape with text, which can be seen when clicking on the macro:

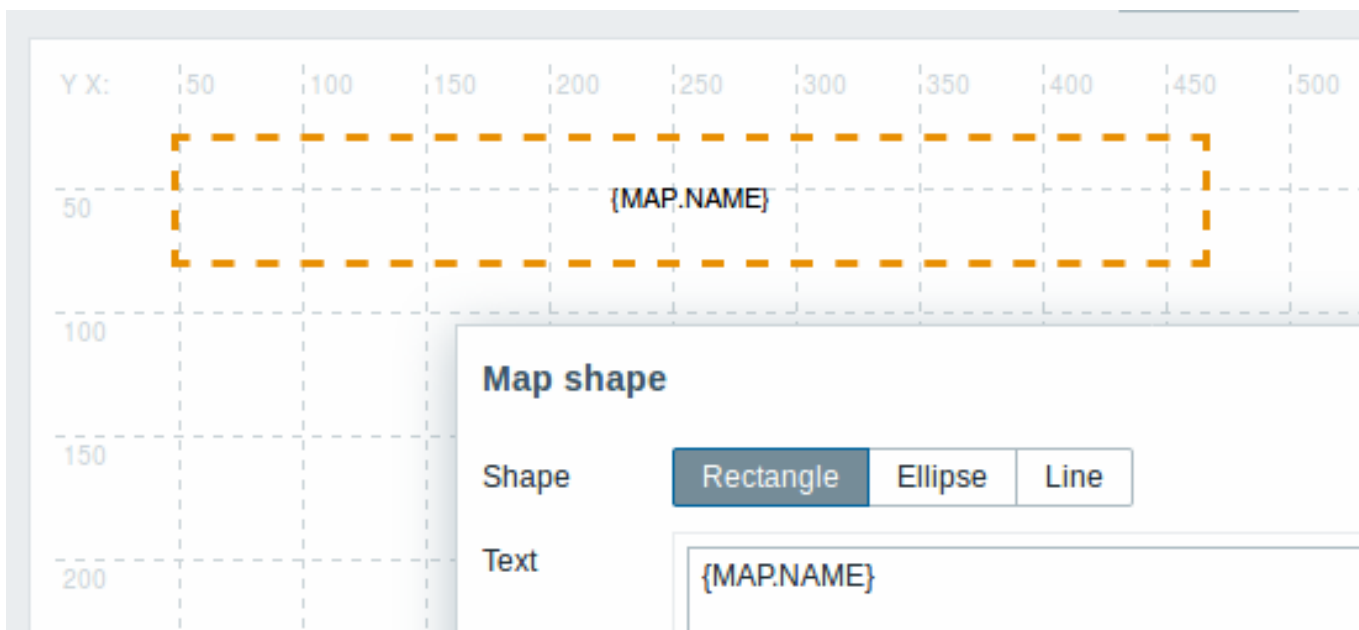

`{MAP.NAME}` resolves to the configured map name when viewing the map.

If hyperlinks are used in the text, they become clickable when viewing the map.

Line wrapping for text is always "on" within shapes. However, within an ellipse, the lines are wrapped as though the ellipse were a rectangle. Word wrapping is not implemented, so long words (words that do not fit the shape) are not wrapped, but are masked

(on map editing page) or clipped (other pages with maps).

Adding lines

In addition to shapes, it is also possible to add some lines. Lines can be used to link elements or shapes in a map.

To add a line, click on *Add* next to Shape. A new shape will appear at the top left corner of the map. Select it and click on *Line* in the editing form to change the shape into a line. Then adjust line properties, such as line type, width, color, etc.

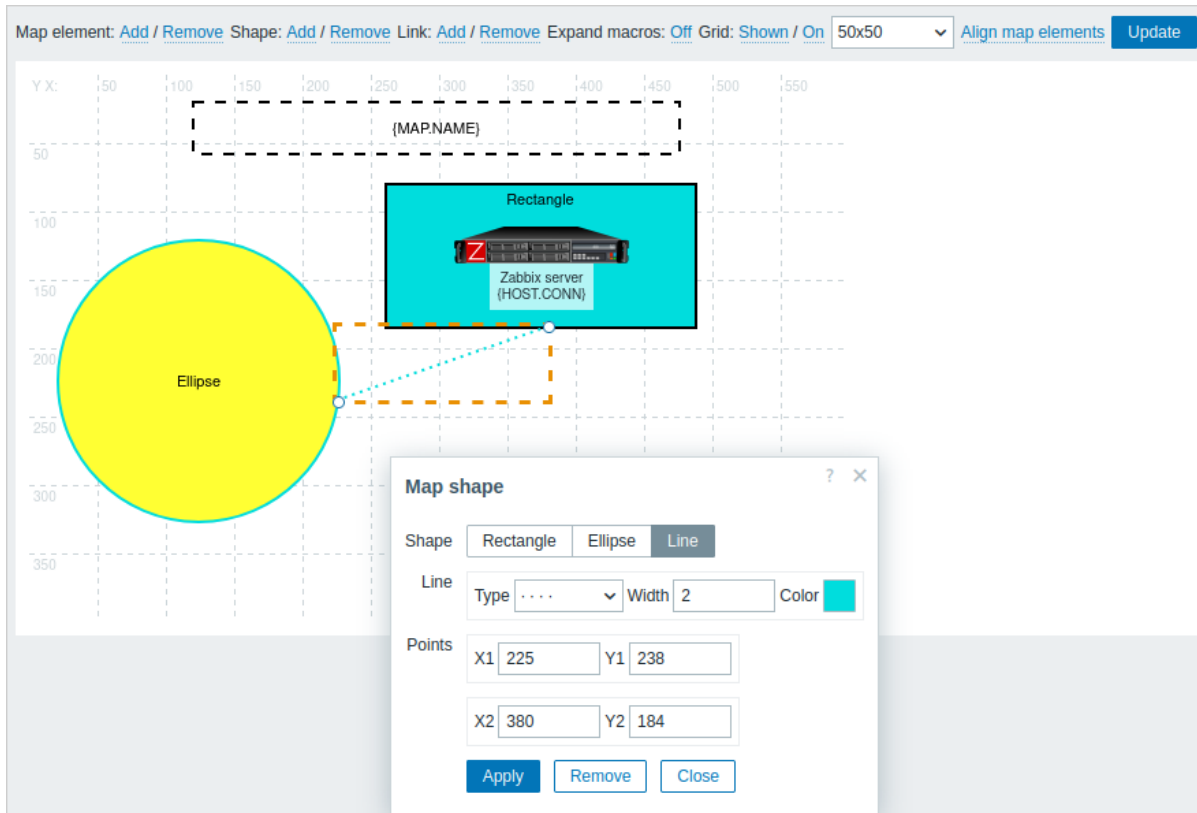

Ordering shapes and lines

To bring one shape in front of the other (or vice versa) click on the shape with the right mouse button bringing up the map shape menu.

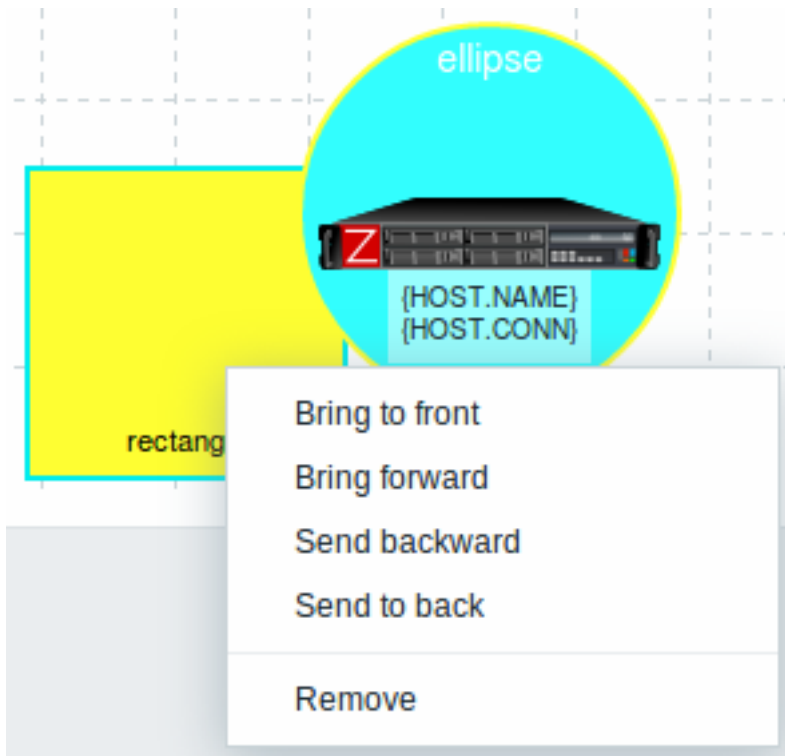

2 Host group elements

Overview

This section explains how to add a “Host group” type element when configuring a **network map**.

Configuration

Map element: [Add / Remove](#) Shape: [Add / Remove](#) Link: [Add / Remove](#) Expand macros: [Off](#) Grid: [Shown / On](#) 50x50 [Align map elements](#)

Y X: 50 100 150 200 250 Local network 2 400 450 500 550 600 650

50
100
150
200
250
300
350
400

Servers

[HOST.HOST]

Map element

Type

Show

Area type

Area size Width Height

Placing algorithm

Label

Label location

* Host group

Application

All mandatory input fields are marked with a red asterisk.

This table consists of parameters typical for *Host group* element type:

Parameter	Description
<i>Type</i>	Select Type of the element: Host group - icon representing the status of all triggers of all hosts belonging to the selected group
<i>Show</i>	Show options: Host group - selecting this option will result as one single icon displaying corresponding information about the certain host group Host group elements - selecting this option will result as multiple icons displaying corresponding information about every single element (host) of the certain host group

Parameter	Description
Area type	This setting is available if the "Host group elements" parameter is selected: Fit to map - all host group elements are equally placed within the map Custom size - a manual setting of the map area for all the host group elements to be displayed
Area size	This setting is available if "Host group elements" parameter and "Area type" parameter are selected: Width - numeric value to be entered to specify map area width Height - numeric value to be entered to specify map area height
Placing algorithm	Grid - only available option of displaying all the host group elements
Label	Icon label, any string. Macros and multiline strings can be used in labels. If the type of the map element is "Host group" specifying certain macros has an impact on the map view displaying corresponding information about every single host. For example, if {HOST.IP} macro is used, the edit map view will only display the macro {HOST.IP} itself while map view will include and display each host's unique IP address

Viewing host group elements

This option is available if the "Host group elements" show option is chosen. When selecting "Host group elements" as the *show* option, you will at first see only one icon for the host group. However, when you save the map and then go to the map view, you will see that the map includes all the elements (hosts) of the certain host group:

Map editing view

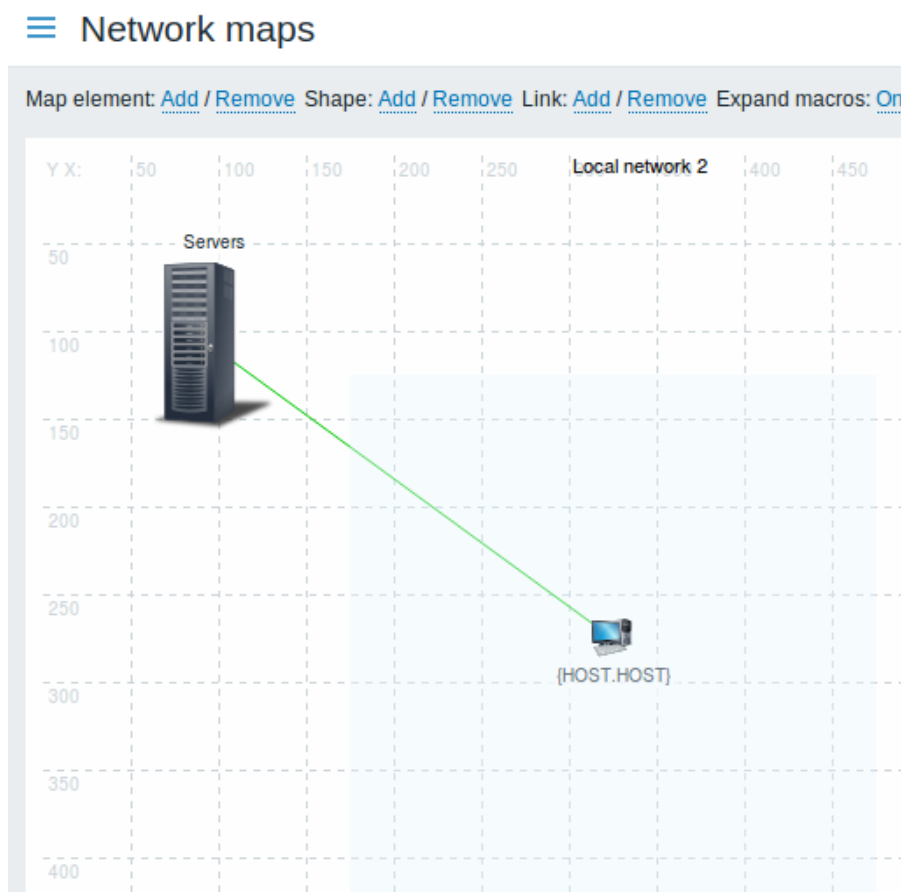

Map view

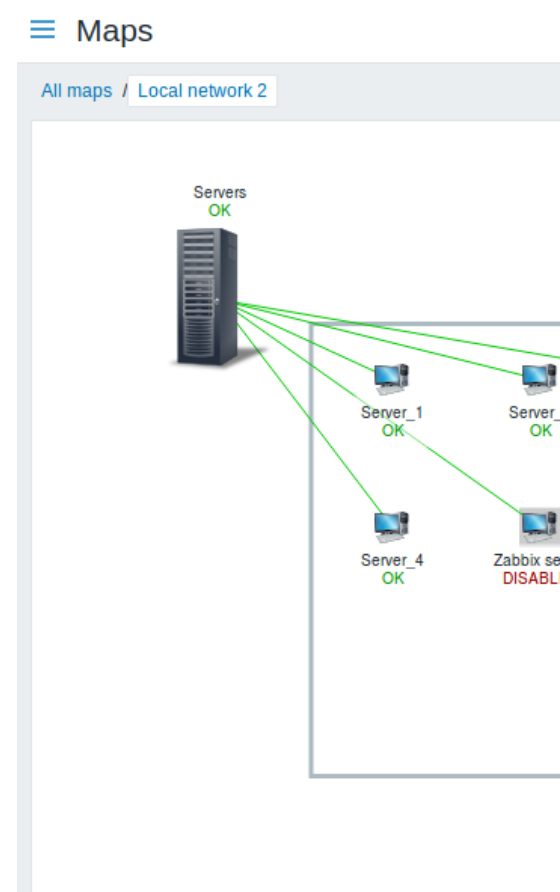

Notice how the {HOST.NAME} macro is used. In map editing, the macro name is unresolved, while in map view all the unique names of the hosts are displayed.

3 Link indicators

Overview

You can assign some triggers to a **link** between elements in a network map. When these triggers go into a problem state, the link can reflect that.

When you configure a link, you set the default link type and color. When you assign triggers to a link, you can assign different link types and colors with these triggers.

Should any of these triggers go into a problem state, their link style and color will be displayed on the link. So maybe your default link was a green line. Now, with the trigger in the problem state, your link may become bold red (if you have defined it so).

Configuration

To assign triggers as link indicators, do the following:

- select a map element
- click on *Edit* in the *Links* section for the appropriate link
- click on *Add* in the *Link indicators* block and select one or more triggers

All mandatory input fields are marked with a red asterisk.

Added triggers can be seen in the *Link indicators* list.

You can set the link type and color for each trigger directly from the list. When done, click on *Apply*, close the form and click on *Update* to save the map changes.

Display

In *Monitoring* → *Maps* the respective color will be displayed on the link if the trigger goes into a problem state.

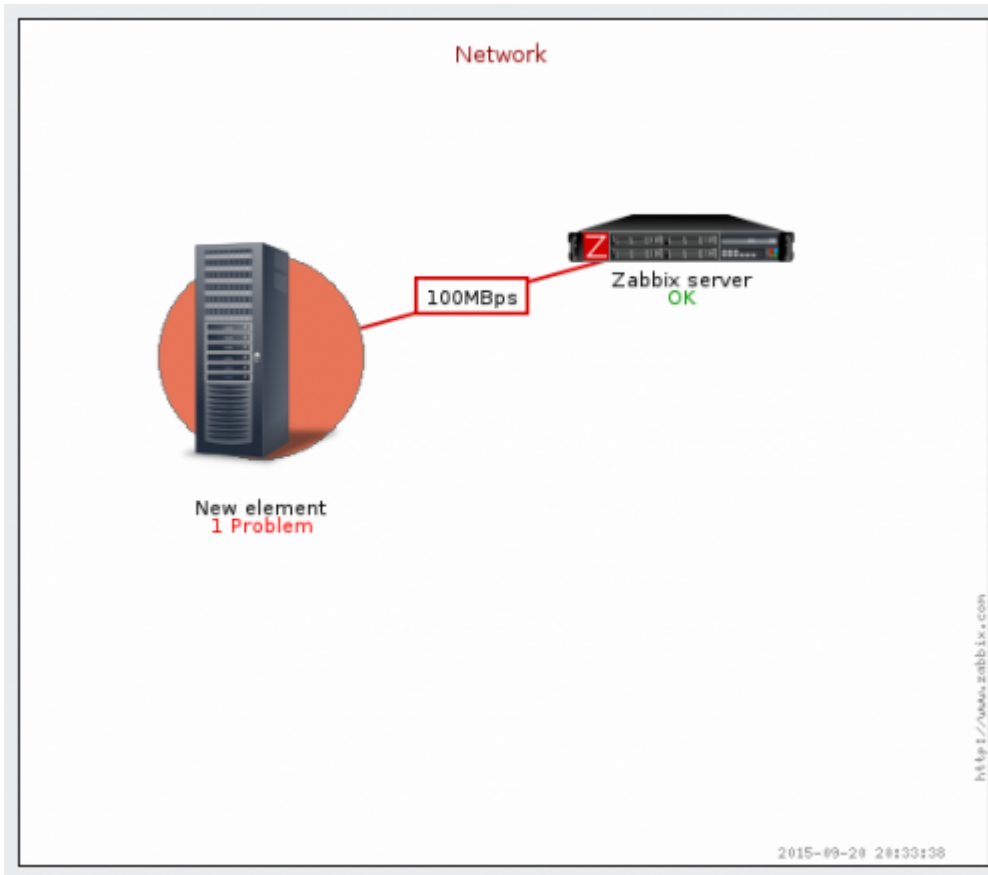

Note:

If multiple triggers go into a problem state, the problem with the highest severity will determine the link style and color. If multiple triggers with the same severity are assigned to the same map link, the one with the lowest ID takes precedence. Note also that:

1. *Minimum trigger severity* and *Show suppressed problem* settings from map configuration affect which problems are taken into account.
2. In the case of triggers with multiple problems (multiple problem generation), each problem may have a severity that differs from trigger severity (changed manually), may have different tags (due to macros), and may be suppressed.

3 Dashboards

Dashboards - both **global dashboards** and **host dashboards** - provide a strong visualization platform with such **widgets** and tools as modern graphs, maps, slideshows, and more.

The screenshot shows a Zabbix dashboard with several widgets. At the top left, there are navigation tabs for 'All dashboards / Global view', 'Page 1', 'Page 2', and 'Page 3', along with a 'Stop slideshow' button. The 'Top hosts by CPU utilization' widget shows a table with columns for Host name, Utilization, 1m avg, 5m avg, 15m avg, and Processes. The 'Zabbix server' row shows 8.67% utilization and 262 processes. A large '2.78' value with a downward arrow is displayed, labeled 'Zabbix server Values per second'. The 'System information' widget is a table with columns for Parameter, Value, and Details. The 'Host availability' widget shows a bar chart with 2 Available, 0 Not available, 0 Mixed, 0 Unknown, and 2 Total. The 'Problems by severity' widget shows a bar chart with 0 Disaster, 0 High, 0 Average, 4 Warning, 0 Information, and 0 Not classified. The 'Current problems' widget is a table with columns for Time, Info, Host, Problem + Severity, Duration, Update, Actions, and Tags. The 'Geomap' widget shows a map of Riga, Latvia, with various markers and a search bar.

8 Templates and template groups

Overview

The use of templates is an excellent way of reducing one's workload and streamlining the Zabbix configuration. A template is a set of entities that can be conveniently applied to multiple hosts.

The entities may be:

- items
- triggers
- graphs
- dashboards
- low-level discovery rules
- web scenarios

As many hosts in real life are identical or fairly similar so it naturally follows that the set of entities (items, triggers, graphs,...) you have created for one host, may be useful for many. Of course, you could copy them to each new host, but that would be a lot of manual work. Instead, with templates you can copy them to one template and then apply the template to as many hosts as needed.

When a template is linked to a host, all entities (items, triggers, graphs,...) of the template are added to the host. Templates are assigned to each individual host directly (and not to a host group).

Templates are often used to group entities for particular services or applications (like Apache, MySQL, PostgreSQL, Postfix...) and then applied to hosts running those services.

Another benefit of using templates is when something has to be changed for all the hosts. Changing something on the template level once will propagate the change to all the linked hosts.

Templates are organized in template **groups**.

Proceed to [creating and configuring a template](#).

9 Templates out of the box

Overview

Zabbix strives to provide a growing list of useful out-of-the-box **templates**. Out-of-the-box templates come preconfigured and thus are a useful way for speeding up the deployment of monitoring jobs.

The templates are available:

- In new installations - in *Data collection* → *Templates*;
- If you are upgrading Zabbix, the upgraded installation might lack newer templates. You can find them in the Zabbix [Git repository](#) - select the version you upgraded to. To add a new template, download the template file, open Zabbix frontend, go to *Data collection* → *Templates*, and import the file.

Please use the sidebar to access information about specific template types and operation requirements.

See also:

- [Template import](#)
- [Linking a template](#)
- [Known issues](#)

1 Zabbix agent template operation

Steps to ensure correct operation of templates that collect metrics with **Zabbix agent**:

1. Make sure that Zabbix agent is installed on the host. For active checks, also make sure that the host is added to the 'ServerActive' parameter of the agent [configuration file](#).
2. [Link](#) the template to a target host (if the template is not available in your Zabbix installation, you may need to import the template's .xml file first - see [Templates out-of-the-box](#) section for instructions).
3. If necessary, adjust the values of template macros.
4. Configure the instance being monitored to allow sharing data with Zabbix.

A detailed description of a template, including the full list of macros, items and triggers is available in the template's Readme.md file (accessible by clicking on a template name).

The following templates are available:

- [Apache by Zabbix agent](#)
- [Apache by Zabbix agent active](#)
- [HAProxy by Zabbix agent](#)
- [IIS by Zabbix agent](#)
- [IIS by Zabbix agent active](#)
- [Microsoft Exchange Server 2016 by Zabbix agent](#)
- [Microsoft Exchange Server 2016 by Zabbix agent active](#)
- [MySQL by Zabbix agent](#)
- [MySQL by Zabbix agent active](#)
- [Nginx by Zabbix agent](#)
- [Nginx by Zabbix agent active](#)
- [PHP-FPM by Zabbix agent](#)
- [PHP-FPM by Zabbix agent active](#)
- [PostgreSQL by Zabbix agent](#)
- [PostgreSQL by Zabbix agent active](#)
- [RabbitMQ cluster by Zabbix agent](#)

2 Zabbix agent 2 template operation

Steps to ensure correct operation of templates that collect metrics with **Zabbix agent 2**:

1. Make sure that the agent 2 is installed on the host, and that the installed version contains the required plugin. In some cases, you may need to [upgrade](#) the agent 2 first.
2. [Link](#) the template to a target host (if the template is not available in your Zabbix installation, you may need to import the template's import file first - see [Templates out-of-the-box](#) section for instructions).
3. If necessary, adjust the values of template macros. Note that user macros can be used to override configuration parameters.
4. Configure the instance being monitored to allow sharing data with Zabbix.

Attention:

Zabbix agent 2 templates work in conjunction with the plugins. While the basic configuration can be done by simply adjusting user macros, the deeper customization can be achieved by [configuring the plugin](#) itself. For example, if a plugin supports named sessions, it is possible to monitor several entities of the same kind (e.g. MySQL1 and MySQL2) by specifying named session with own URI, username and password for each entity in the configuration file.

A detailed description of a template, including the full list of macros, items and triggers is available in the template's Readme.md file (accessible by clicking on a template name).

The following templates are available:

- [Ceph by Zabbix agent 2](#)
- [Docker](#)
- [Memcached](#)
- [MongoDB cluster by Zabbix agent 2](#)
- [MongoDB node by Zabbix agent 2](#)
- [MySQL by Zabbix agent 2](#)
- [MySQL by Zabbix agent 2 active](#)
- [Oracle by Zabbix agent 2](#)
- [PostgreSQL by Zabbix agent 2](#)
- [PostgreSQL by Zabbix agent 2 active](#)
- [Redis](#)
- [SMART by Zabbix agent 2](#)
- [SMART by Zabbix agent 2 active](#)
- [Systemd by Zabbix agent 2](#)
- [Website certificate by Zabbix agent 2](#)

3 HTTP template operation

Steps to ensure correct operation of templates that collect metrics with **HTTP agent**:

1. Create a host in Zabbix and specify an IP address or DNS name of the monitoring target as the main interface. This is needed for the {HOST.CONN} macro to resolve properly in the template items.
2. [Link](#) the template to the host created in step 1 (if the template is not available in your Zabbix installation, you may need to import the template's .xml file first - see [Templates out-of-the-box](#) section for instructions).
3. If necessary, adjust the values of template macros.
4. Configure the instance being monitored to allow sharing data with Zabbix.

A detailed description of a template, including the full list of macros, items and triggers is available in the template's Readme.md file (accessible by clicking on a template name).

The following templates are available:

- [Acronis Cyber Protect Cloud by HTTP](#)
- [Apache by HTTP](#)
- [Asterisk by HTTP](#)
- [AWS by HTTP](#)
- [AWS Cost Explorer by HTTP](#)
- [AWS EC2 by HTTP](#)
- [AWS ECS Cluster by HTTP](#)
- [AWS ECS Serverless Cluster by HTTP](#)
- [AWS ELB Application Load Balancer by HTTP](#)
- [AWS ELB Network Load Balancer by HTTP](#)
- [AWS Lambda by HTTP](#)
- [AWS RDS instance by HTTP](#)
- [AWS S3 bucket by HTTP](#)
- [Azure by HTTP](#)
- [Cisco Meraki organization by HTTP](#)
- [Cisco SD-WAN by HTTP](#)
- [ClickHouse by HTTP](#)
- [Cloudflare by HTTP](#)
- [CockroachDB by HTTP](#)
- [Control-M enterprise manager by HTTP](#)
- [Control-M server by HTTP](#)
- [DELL PowerEdge R720 by HTTP](#)
- [DELL PowerEdge R740 by HTTP](#)
- [DELL PowerEdge R820 by HTTP](#)
- [DELL PowerEdge R840 by HTTP](#)
- [Elasticsearch Cluster by HTTP](#)
- [Envoy Proxy by HTTP](#)
- [Etd by HTTP](#)
- [FortiGate by HTTP](#)
- [GitHub repository by HTTP](#)
- [GitLab by HTTP](#)
- [Google Cloud Platform \(GCP\) by HTTP](#)
- [Hadoop by HTTP](#)
- [HAProxy by HTTP](#)
- [HashiCorp Consul Cluster by HTTP](#)
- [HashiCorp Consul Node by HTTP](#)
- [HashiCorp Nomad by HTTP](#)
- [HashiCorp Vault by HTTP](#)
- [Hikvision camera by HTTP](#)
- [HPE iLO by HTTP](#)
- [HPE MSA 2040 Storage by HTTP](#)
- [HPE MSA 2060 Storage by HTTP](#)
- [HPE Primera by HTTP](#)
- [HPE Synergy by HTTP](#)
- [InfluxDB by HTTP](#)
- [Jenkins by HTTP](#)
- [Kubernetes API server by HTTP](#)
- [Kubernetes cluster state by HTTP](#)

- [Kubernetes Controller manager by HTTP](#)

- [Kubernetes kubelet by HTTP](#)

- [Kubernetes nodes by HTTP](#)
- [Kubernetes Scheduler by HTTP](#)
- [MantisBT by HTTP](#)
- [Microsoft 365 reports by HTTP](#)
- [Microsoft SharePoint by HTTP](#)
- [NetApp AFF A700 by HTTP](#)
- [Nextcloud by HTTP](#)
- [NGINX by HTTP](#)
- [NGINX Plus by HTTP](#)
- [Nutanix Prism Element by HTTP](#)
- [OpenStack by HTTP](#)
- [OpenWeatherMap by HTTP](#)
- [Oracle Cloud by HTTP](#)
- [PHP-FPM by HTTP](#)
- [Proxmox VE by HTTP](#)
- [RabbitMQ cluster by HTTP](#)
- [TiDB by HTTP](#)
- [TiDB PD by HTTP](#)
- [TiDB TiKV by HTTP](#)
- [Travis CI by HTTP](#)
- [Veeam Backup Enterprise Manager by HTTP](#)
- [Veeam Backup and Replication by HTTP](#)
- [VMware SD-WAN VeloCloud by HTTP](#)
- [YugabyteDB by HTTP](#)
- [ZooKeeper by HTTP](#)

4 IPMI template operation

IPMI templates do not require any specific setup. To start monitoring, [link](#) the template to a target host (if the template is not available in your Zabbix installation, you may need to import the template's .xml file first - see [Templates out-of-the-box](#) section for instructions).

A detailed description of a template, including the full list of macros, items and triggers is available in the template's Readme.md file (accessible by clicking on a template name).

Available template:

- [Chassis by IPMI](#)

5 JMX template operation

Steps to ensure correct operation of templates that collect metrics by [JMX](#):

1. Make sure Zabbix [Java gateway](#) is installed and set up properly.
2. [Link](#) the template to the target host. The host should have JMX interface set up.

If the template is not available in your Zabbix installation, you may need to import the template's .xml file first - see [Templates out-of-the-box](#) section for instructions.

3. If necessary, adjust the values of template macros.
4. Configure the instance being monitored to allow sharing data with Zabbix.

A detailed description of a template, including the full list of macros, items and triggers is available in the template's Readme.md file (accessible by clicking on a template name).

The following templates are available:

- [Apache ActiveMQ by JMX](#)
- [Apache Cassandra by JMX](#)
- [Apache Kafka by JMX](#)
- [Apache Tomcat by JMX](#)
- [GridGain by JMX](#)
- [Ignite by JMX](#)
- [Jira Data Center by JMX](#)
- [WildFly Domain by JMX](#)

- [WildFly Server by JMX](#)

6 ODBC template operation

Steps to ensure correct operation of templates that collect metrics via **ODBC monitoring**:

1. Make sure that required ODBC driver is installed on Zabbix server or proxy.
2. [Link](#) the template to a target host (if the template is not available in your Zabbix installation, you may need to import the template's .xml file first - see [Templates out-of-the-box](#) section for instructions).
3. If necessary, adjust the values of template macros.
4. Configure the instance being monitored to allow sharing data with Zabbix.

A detailed description of a template, including the full list of macros, items and triggers is available in the template's `Readme.md` file (accessible by clicking on a template name).

The following templates are available:

- [MSSQL by ODBC](#)
- [MySQL by ODBC](#)
- [Oracle by ODBC](#)
- [PostgreSQL by ODBC](#)

7 Standardized templates for network devices

Overview

In order to provide monitoring for network devices such as switches and routers, we have created two so-called models: for the network device itself (its chassis basically) and for network interface.

Templates for many families of network devices are provided. All templates cover (where possible to get these items from the device):

- Chassis fault monitoring (power supplies, fans and temperature, overall status)
- Chassis performance monitoring (CPU and memory items)
- Chassis inventory collection (serial numbers, model name, firmware version)
- Network interface monitoring with IF-MIB and EtherLike-MIB (interface status, interface traffic load, duplex status for Ethernet)

These templates are available:

- In new installations - in *Data collection* → *Templates*;
- If you are upgrading from previous versions, you can find these templates in the `zabbix/templates` directory of the downloaded latest Zabbix version. While in *Data collection* → *Templates* you can import them manually from this directory.

If you are importing the new out-of-the-box templates, you may want to also update the `@Network` interfaces for discovery global regular expression to:

```
Result is FALSE: ^Software Loopback Interface
Result is FALSE: ^(In)?[lL]oop[bB]ack[0-9._]*$
Result is FALSE: ^NULL[0-9._]*$
Result is FALSE: ^[lL]o[0-9._]*$
Result is FALSE: ^[sS]ystem$
Result is FALSE: ^Nu[0-9._]*$
```

to filter out loopbacks and null interfaces on most systems.

Devices

List of device families for which templates are available:

Template name	Vendor	Device family	Known models	OS	MIBs used	Tags
<i>Alcatel Timetra</i> <i>TiMOS SNMP</i>	Alcatel	Alcatel Timetra	ALCATEL SR 7750	TIMOS	TIMETRA-SYSTEM-MIB,TIMETRA-CHASSIS-MIB	Certified
<i>Brocade FC SNMP</i>	Brocade	Brocade FC switches	Brocade 300 SAN Switch-	-	SW-MIB,ENTITY-MIB	Performance Fault

Template name	Vendor	Device family	Known models	OS	MIBs used	Tags
<i>Brocade_Foundry Stackable SNMP</i>	Brocade	Brocade ICX	Brocade ICX6610, Brocade ICX7250-48, Brocade ICX7450-48F		FOUNDRY-SN-AGENT-MIB, FOUNDRY-SN-STACKING-MIB	Certified
<i>Brocade_Foundry Nonstackable SNMP</i>	Brocade, Foundry	Brocade MLX, Foundry	Brocade MLXe, Foundry FLS648, Foundry FWSX424		FOUNDRY-SN-AGENT-MIB	Performance Fault
<i>Check Point Next Generation Firewall by SNMP</i>	Check Point	Next Generation Firewall	-	Gaia	HOST-RESOURCES-MIB, CHECKPOINT-MIB, UCD-SNMP-MIB, SNMPv2-MIB, IF-MIB	Certified
<i>Cisco Catalyst 3750<device model> SNMP</i>	Cisco	Cisco Catalyst 3750	Cisco Catalyst 3750V2-24FS, Cisco Catalyst 3750V2-24PS, Cisco Catalyst 3750V2-24TS, Cisco Catalyst SNMP, Cisco Catalyst SNMP		CISCO-MEMORY-POOL-MIB, IF-MIB, EtherLike-MIB, SNMPv2-MIB, CISCO-PROCESS-MIB, CISCO-ENVMON-MIB, ENTITY-MIB	Certified
<i>Cisco IOS SNMP</i>	Cisco	Cisco IOS ver > 12.2 3.5	Cisco C2950	IOS	CISCO-PROCESS-MIB,CISCO-MEMORY-POOL-MIB,CISCO-ENVMON-MIB	Certified
<i>Cisco IOS versions 12.0_3_T-12.2_3.5 SNMP</i>	Cisco	Cisco IOS > 12.0 3 T and 12.2 3.5	-	IOS	CISCO-PROCESS-MIB,CISCO-MEMORY-POOL-MIB,CISCO-ENVMON-MIB	Certified
<i>Cisco IOS prior to 12.0_3_T SNMP</i>	Cisco	Cisco IOS 12.0 3 T	-	IOS	OLD-CISCO-CPU-MIB,CISCO-MEMORY-POOL-MIB	Certified
<i>D-Link DES_DGS Switch SNMP</i>	D-Link	DES/DGX switches	D-Link DES-xxxx/DGS-xxxx,DLINK DGS-3420-26SC	-	DLINK-AGENT-MIB,EQUIPMENT-MIB,ENTITY-MIB	Certified
<i>D-Link DES 7200 SNMP</i>	D-Link	DES-7xxx	D-Link DES 7206	-	ENTITY-MIB,MY-SYSTEM-MIB,MY-PROCESS-MIB,MY-MEMORY-MIB	Performance Fault Interfaces
<i>Dell Force S-Series SNMP</i>	Dell	Dell Force S-Series	S4810		F10-S-SERIES-CHASSIS-MIB	Certified
<i>Extreme Exos SNMP</i>	Extreme	Extreme EXOS	X670V-48x	EXOS	EXTREME-SYSTEM-MIB,EXTREME-SOFTWARE-MONITOR-MIB	Certified

Template name	Vendor	Device family	Known models	OS	MIBs used	Tags
<i>FortiGate by SNMP</i>	Fortinet	FortiGate (NGFW)	-	FortiOS	HOST-RESOURCES-MIB FORTINET-FORTIGATE-MIB FORTINET-CORE-MIB SNMPv2-MIB IF-MIB ENTITY-MIB	Performance Inventory
<i>Huawei VRP SNMP</i>	Huawei	Huawei VRP	S2352P-EI	-	ENTITY-MIB,HUAWEI-ENTITY-EXTENT-MIB	Certified
<i>Intel_Qlogic Infiniband SNMP</i>	Intel/QLogic	Intel/QLogic Infiniband devices	Infiniband 12300		ICS-CHASSIS-MIB	Fault Inventory
<i>Juniper SNMP</i>	Juniper	MX,SRX,EX models	Juniper MX240, Juniper EX4200-24F	JunOS	JUNIPER-MIB	Certified
<i>Juniper MX SNMP</i>	Juniper	MX models	Juniper MX204 Edge Router	JunOS 24.2R1-S1.10	OSPF-MIB, JUNIPER-DOM-MIB, JUNIPER-MIB, BGP4-V2-MIB- JUNIPER, OSPFV3-MIB- JUNIPER	Certified
<i>Mellanox SNMP</i>	Mellanox	Mellanox Infiniband devices	SX1036	MLNX-OS	HOST-RESOURCES-MIB,ENTITY-MIB,ENTITY-SENSOR-MIB,MELLANOX-MIB	Certified

Template name	Vendor	Device family	Known models	OS	MIBs used	Tags
<i>MikroTik CCR<device model> SNMP</i>	MikroTik	MikroTik Cloud Core Routers (CCR series)	Separate dedicated templates are available for MikroTik CCR1009-7G-1C-1S+, MikroTik CCR1009-7G-1C-1S+PC, MikroTik CCR1009-7G-1C-PC, MikroTik CCR1016-12G, MikroTik CCR1016-12S-1S+, MikroTik CCR1036-12G-4S-EM, MikroTik CCR1036-12G-4S, MikroTik CCR1036-8G-2S+, MikroTik CCR1036-8G-2S+EM, MikroTik CCR1072-1G-8S+, MikroTik CCR2004-16G-2S+, MikroTik CCR2004-1G-12S+2XS	RouterOS	MIKROTIK-MIB,HOST-RESOURCES-MIB	Certified

Template name	Vendor	Device family	Known models	OS	MIBs used	Tags
<i>MikroTik CRS<device model> SNMP</i>	MikroTik	MikroTik Cloud Router Switches (CRS series)	Separate dedicated templates are available for MikroTik CRS106-1C-5S, MikroTik CRS109-8G-1S-2HnD-IN, MikroTik CRS112-8G-4S-IN, MikroTik CRS112-8P-4S-IN, MikroTik CRS125-24G-1S-2HnD-IN, MikroTik CRS212-1G-10S-1S+IN, MikroTik CRS305-1G-4S+IN, MikroTik CRS309-1G-8S+IN, MikroTik CRS312-4C+8XG-RM, MikroTik CRS317-1G-16S+RM, MikroTik CRS326-24G-2S+IN, MikroTik CRS326-24G-2S+RM, MikroTik CRS326-24S+2Q+RM, MikroTik CRS328-24P-4S+RM, MikroTik CRS328-4C-20S-4S+RM, MikroTik CRS354-48G-4S+2Q+RM, MikroTik CRS354-48P-4S+2Q+RM	RouterOS/SwitchOS	MIKROTIK-MIB,HOST-RESOURCES-MIB	Certified
<i>MikroTik CSS<device model> SNMP</i>	MikroTik	MikroTik Cloud Smart Switches (CSS series)	Separate dedicated templates are available for MikroTik CSS326-24G-2S+RM, MikroTik CSS610-8G-2S+IN	RouterOS	MIKROTIK-MIB,HOST-RESOURCES-MIB	Certified
<i>MikroTik FiberBox SNMP</i>	MikroTik	MikroTik FiberBox	MikroTik FiberBox	RouterOS	MIKROTIK-MIB,HOST-RESOURCES-MIB	Certified
<i>MikroTik hEX <device model> SNMP</i>	MikroTik	MikroTik hEX	Separate dedicated templates are available for MikroTik hEX, MikroTik hEX lite, MikroTik hEX PoE, MikroTik hEX PoE lite, MikroTik hEX S	RouterOS	MIKROTIK-MIB,HOST-RESOURCES-MIB	Certified

Template name	Vendor	Device family	Known models	OS	MIBs used	Tags
<i>MikroTik netPower</i> <device model> SNMP	MikroTik	MikroTik net-Power	Separate dedicated templates are available for MikroTik netPower 15FR, MikroTik netPower 16P SNMP, MikroTik netPower Lite 7R	RouterOS/SwitchOS Lite	MIKROTIK-MIB,HOST-RESOURCES-MIB	Certified
<i>MikroTik PowerBox</i> <device model> SNMP	MikroTik	MikroTik Power-Box	Separate dedicated templates are available for MikroTik PowerBox, MikroTik PowerBox Pro	RouterOS	MIKROTIK-MIB,HOST-RESOURCES-MIB	Certified
<i>MikroTik RB</i> <device model> SNMP	MikroTik	MikroTik RB series routers	Separate dedicated templates are available for MikroTik RB1100AHx4, MikroTik RB1100AHx4 Dude Edition, MikroTik RB2011iL-IN, MikroTik RB2011iL-RM, MikroTik RB2011iLS-IN, MikroTik RB2011UiAS-IN, MikroTik RB2011UiAS-RM, MikroTik RB260GS, MikroTik RB3011UiAS-RM, MikroTik RB4011iGS+RM, MikroTik RB5009UG+S+IN	RouterOS	MIKROTIK-MIB,HOST-RESOURCES-MIB	Certified
<i>MikroTik SNMP</i>	MikroTik	MikroTik RouterOS devices	MikroTik CCR1016-12G, MikroTik RB2011UAS-2HnD, MikroTik 912UAG-5HPnD, MikroTik 941-2nD, MikroTik 951G-2HnD, MikroTik 1100AHx2	RouterOS	MIKROTIK-MIB,HOST-RESOURCES-MIB	Certified
<i>QTech QSW SNMP</i>	QTech	Qtech devices	Qtech QSW-2800-28T	-	QTECH-MIB,ENTITY-MIB	Performance Inventory

Template name	Vendor	Device family	Known models	OS	MIBs used	Tags
<i>Ubiquiti AirOS SNMP</i>	Ubiquiti	Ubiquiti AirOS wireless devices	NanoBridge, NanoStation	Ubiquiti	FROGFOOT-RESOURCES-MIB, IEEE802dot11-MIB	Performance
<i>HP Comware HH3C SNMP</i>	HP	HP (H3C) Comware	HP A5500-24G-4SFP HI Switch		HH3C-ENTITY-EXT-MIB, ENTITY-MIB	Certified
<i>HP Enterprise Switch SNMP</i>	HP	HP Enterprise Switch	HP ProCurve J4900B Switch 2626, HP J9728A 2920-48G Switch		STATISTICS-MIB, NETSWITCH-MIB, HP-ICF-CHASSIS, ENTITY-MIB, SEMI-MIB	Certified
<i>TP-LINK SNMP</i>	TP-LINK	TP-LINK	T2600G-28TS v2.0		TPLINK-SYSMONITOR-MIB, TPLINK-SYSINFO-MIB	Performance Inventory
<i>Netgear Fastpath SNMP</i>	Netgear	Netgear Fastpath	M5300-28G		FASTPATH-SWITCHING-MIB, FASTPATH-BOXSERVICES-PRIVATE-MIB	Fault Inventory

Template design

Templates were designed with the following in mind:

- User macros are used as much as possible so triggers can be tuned by the user;
- Low-level discovery is used as much as possible to minimize the number of unsupported items;
- All templates depend on Template ICMP Ping so all devices are also checked by ICMP;
- Items don't use any MIBs - SNMP OIDs are used in items and low-level discoveries. So it's not necessary to load any MIBs into Zabbix for templates to work;
- Loopback network interfaces are filtered when discovering as well as interfaces with ifAdminStatus = down(2)
- 64bit counters are used from IF-MIB::ifXTable where possible. If it is not supported, default 32bit counters are used instead.

All discovered network interfaces have a trigger that monitors its operational status (link), for example:

```
{$IFCONTROL:"{#IFNAME}"}=1 and last(/Alcatel Timetra TiMOS SNMP/net.if.status[ifOperStatus.{#SNMPINDEX}]
```

- If you do not want to monitor this condition for a specific interface create a user macro with context with the value 0. For example:

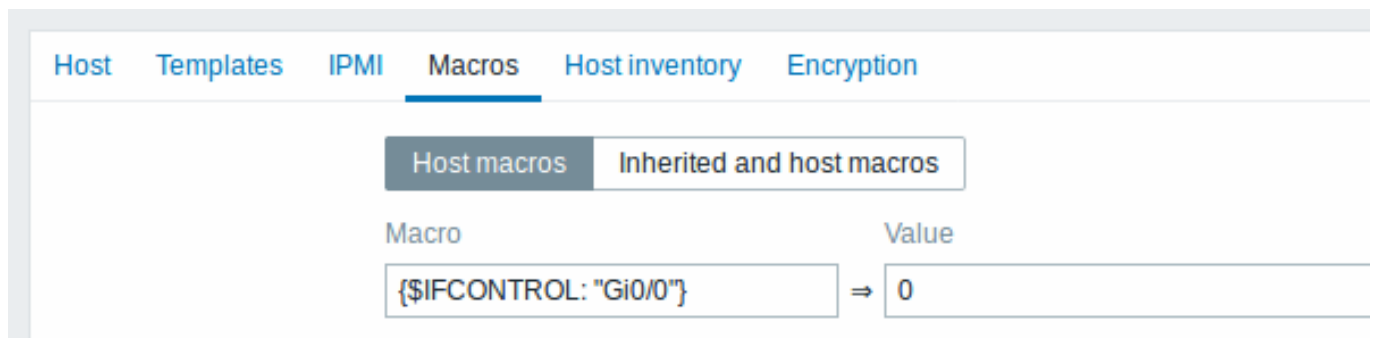

where Gi0/0 is {#IFNAME}. That way the trigger is not used any more for this specific interface.

- You can also change the default behavior for all triggers not to fire and activate this trigger only to limited number of interfaces like uplinks:

Host Templates IPMI **Macros** Host inventory Encryption

Host macros Inherited and host macros

Macro	Value
{\$IFCONTROL}	⇒ 0
{\$IFCONTROL: "Gi0/0"}	⇒ 1
{\$IFCONTROL: "Gi0/1"}	⇒ 1

Tags

- Performance – device family MIBs provide a way to monitor CPU and memory items;
- Fault - device family MIBs provide a way to monitor at least one temperature sensor;
- Inventory – device family MIBs provide a way to collect at least the device serial number and model name;
- Certified – all three main categories above are covered.

8 VMware template operation

Overview

Zabbix includes a range of ready-to-use templates for **virtual machine monitoring**, designed for VMware vCenter and ESXi hypervisors. The available templates are contained in two separate template sets:

- **VMware** - uses UUID data for corresponding macros
- **VMware FQDN** - uses FQDN data for corresponding macros

The templates designed for monitoring VMware vCenter or ESXi hypervisors contain pre-configured low-level discovery rules along with various built-in checks for monitoring virtual installations.

Note:

For the correct functioning of the *VMware FQDN* template, each monitored virtual machine should have a unique OS name adhering to FQDN rules. Additionally, VMware Tools/Open Virtual Machine tools must be installed on every machine. If these prerequisites are met, using the *VMware FQDN* template is recommended. The *VMware FQDN* template has been available since Zabbix 5.2 with the introduction of the ability to create hosts with custom interfaces.

 A classic *VMware* template is also available and can be used if FQDN requirements are unmet. However, the *VMware* template has a known issue. Hosts for discovered virtual machines are created with names that are saved in vCenter (for example, "VM1", "VM2", etc.). If Zabbix agent is installed on these hosts, and active Zabbix agent autoregistration is enabled, the autoregistration process will read host names as they were registered during launch (for example, "vm1.example.com", "vm2.example.com", etc.). This can lead to the creation of new hosts for existing virtual machines (since no name matches have been found), resulting in duplicate hosts with different names.

Please note:

- The template *VMware Hypervisor* can be manually linked to a host as well as used in discovery;
- The template *VMware Guest* should not be manually linked to a host and can only be used in discovery.

Host macro configuration

To use VMware simple checks, the host must have the following user macros defined:

- {\$VMWARE.URL} - VMware service (vCenter or ESXi hypervisor) SDK URL (https://servername/sdk)
- {\$VMWARE.USERNAME} - VMware service user name
- {\$VMWARE.PASSWORD} - VMware service {\$VMWARE.USERNAME} user password

10 Notifications upon events

Overview

Assuming that we have configured some items and triggers and now are getting some events happening as a result of triggers changing state, it is time to consider some actions.

To begin with, we would not want to stare at the triggers or events list all the time. It would be much better to receive notification if something significant (such as a problem) has happened. Also, when problems occur, we would like to see that all the people concerned are informed.

That is why sending notifications is one of the primary actions offered by Zabbix. Who and when should be notified upon a certain event can be defined.

To be able to send and receive notifications from Zabbix you have to:

- **define some media**
- **configure an action** that sends a message to one of the defined media

Actions consist of *conditions* and *operations*. Basically, when conditions are met, operations are carried out. The two principal operations are sending a message (notification) and executing a remote command.

For discovery and autoregistration created events, some additional operations are available. Those include adding or removing a host, linking a template etc.

1 Media types

Overview

Media are the delivery channels used for sending notifications and alerts from Zabbix.

You can configure several media types:

- **Email**
- **SMS**
- **Custom alertscripts**
- **Webhook**

Media types are configured in *Alerts* → *Media types*.

Name	Type	Status	Used in actions	Details	Action
Brevis.one	Webhook	Disabled	4	Report not supported items, Report not supported low level discovery rules, Report problems to Zabbix administrators, Report unknown triggers	Test
Discord	Webhook	Disabled	4	Report not supported items, Report not supported low level discovery rules, Report problems to Zabbix administrators, Report unknown triggers	Test
Email	Email	Enabled	4	Report not supported items, Report not supported low level discovery rules, Report problems to Zabbix administrators, Report unknown triggers	SMTP server: "mail.example.com", SMTP helo: "example.com", email: "zabbix@example.com" Test
Email (HTML)	Email	Enabled	4	Report not supported items, Report not supported low level discovery rules, Report problems to Zabbix administrators, Report unknown triggers	SMTP server: "mail.example.com", SMTP helo: "example.com", email: "zabbix@example.com" Test
Event-Driven Ansible	Webhook	Disabled	4	Report not supported items, Report not supported low level discovery rules, Report problems to Zabbix administrators, Report unknown triggers	Test
Express.ms	Webhook	Disabled	4	Report not supported items, Report not supported low level discovery rules, Report problems to Zabbix administrators, Report unknown triggers	Test
GitHub	Webhook	Disabled	4	Report not supported items, Report not supported low level discovery rules, Report problems to Zabbix administrators, Report unknown triggers	Test
GLPI	Webhook	Disabled	4	Report not supported items, Report not supported low level discovery rules, Report problems to Zabbix administrators, Report unknown triggers	Test
Gmail	Email	Disabled	4	Report not supported items, Report not supported low level discovery rules, Report problems to Zabbix administrators, Report unknown triggers	SMTP server: "smtp.gmail.com", email: "zabbix@example.com" Test

Some media types come pre-defined in the default dataset. You just need to finetune their parameters to get them working.

Automated Gmail/Office365 media types

Gmail or Office365 users may benefit from easier media type configuration. The *Email provider* field in the mail media type configuration allows to select pre-configured options for Gmail and Office 365.

When selecting the Gmail/Office365 related options, it is only required to supply the sender email address/password to create a working media type.

New media type
? X

Media type
Message templates 5
Options

* Name

Type

Email provider

* Email

* Password

Message format HTML Plain text

Description

Enabled

As soon as the email address/password is supplied, Zabbix will be able to automatically fill all required settings for Gmail/Office365 media types with the actual/recommended values, i.e., *SMTP server*, *SMTP server port*, *SMTP helo*, and *Connection security*. Because of this automation, these fields are not even shown, however, it is possible to see the SMTP server and email details in the media type list (see the *Details* column).

Note also that:

- The password is not required for the relay options.
- For Office365 relay, the domain name of the provided email address will be used to dynamically fill the SMTP server (i.e., replace "example.com" in `example-com.mail.protection.outlook.com` with the real value).

To test if a configured media type works, click on the *Test* link in the last column (see media type testing for [Email](#), [Webhook](#), or [Script](#) for more details).

To create a new media type, click on the *Create media type* button. A media type configuration form is opened.

Common parameters

Some parameters are common for all media types.

New media type ? X

Media type | Message templates 5 | Options

* Name

Type

* GSM modem

Description

Enabled

In the **Media type** tab the common general attributes are:

Parameter	Description
<i>Name</i>	Name of the media type.
<i>Type</i>	Select the type of media.
<i>Description</i>	Enter a description.
<i>Enabled</i>	Mark the checkbox to enable the media type.

See the individual pages of media types for media-specific parameters.

The **Message templates** tab allows to set default notification messages for all or some of the following event types:

- Problem
- Problem recovery
- Problem update
- Service
- Service recovery
- Service update
- Discovery
- Autoregistration
- Internal problem
- Internal problem recovery

Media type ? X

Media type | Message templates 6 | Options

Message type	Template	Actions
Problem	Problem started at {EVENT.TIME} on {EVENT.DATE} Pro...	Edit Remove
Problem recovery	Problem has been resolved at {EVENT.RECOVERY.TIM...}	Edit Remove
Problem update	{USER.FULLNAME} {EVENT.UPDATE.ACTION} problem...	Edit Remove
Service	Service problem started at {EVENT.TIME} on {EVENT.DA...}	Edit Remove
Service recovery	Service "{SERVICE.NAME}" has been resolved at {EVEN...}	Edit Remove
Autoregistration	Host name: {HOST.HOST} Host IP: {HOST.IP} Agent port...	Edit Remove
Add		

To customize message templates:

1. In the *Message templates* tab click on [Add](#): a *Message template* popup window will open.
2. Select required *Message type* and edit *Subject* and *Message* texts.
3. Click on *Add* to save the message template.

Message template parameters:

Parameter	Description
<i>Message type</i>	Type of an event for which the default message should be used. Only one default message can be defined for each event type.
<i>Subject</i>	Subject of the default message. The subject may contain macros. It is limited to 255 characters. Subject is not available for SMS media type.
<i>Message</i>	The default message. It is limited to certain amount of characters depending on the database type (see Sending messages for more information). The message may contain supported macros . In problem and problem update messages, expression macros are supported (for example, <code>{?avg(/host/key, 1h)}</code>).

To make changes to an existing message template: in the *Actions* column click on [Edit](#) to edit the template or click on [Remove](#) to delete the message template.

It is possible to define a custom message template for a specific action (see [action operations](#) for details). Custom messages defined in the action configuration will override default media type message template.

Warning:

Defining message templates is mandatory for all media types, including webhooks or custom alert scripts that do not use default messages for notifications. For example, an action "Send message to Pushover webhook" will fail to send problem notifications, if the Problem message for the Pushover webhook is not defined.

The **Options** tab contains alert processing settings. The same set of options is configurable for each media type.

All media types are processed in parallel. While the maximum number of concurrent sessions is configurable per media type, the total number of alerter processes on the server can only be limited by the `StartAlerters` [parameter](#). Alerts generated by one trigger are processed sequentially. So multiple notifications may be processed simultaneously only if they are generated by multiple triggers.

New media type ? X

Media type Message templates 4 **Options**

Concurrent sessions **One** Unlimited Custom

* Attempts

* Attempt interval

Parameter	Description
<i>Concurrent sessions</i>	Select the number of parallel alerter sessions for the media type: One - one session Unlimited - unlimited number of sessions Custom - select a custom number of sessions Unlimited/high values mean more parallel sessions and increased capacity for sending notifications. Unlimited/high values should be used in large environments where lots of notifications may need to be sent simultaneously. If more notifications need to be sent than there are concurrent sessions, the remaining notifications will be queued; they will not be lost.
<i>Attempts</i>	Number of attempts for trying to send a notification. Up to 100 attempts can be specified; the default value is '3'. If '1' is specified, Zabbix will send the notification only once and will not retry if the sending fails.
<i>Attempt interval</i>	Frequency of trying to resend a notification in case the sending failed, in seconds (0-3600). If '0' is specified, Zabbix will retry immediately. Time suffixes are supported, e.g., 5s, 3m, 1h.

User media

To receive notifications of a media type, a medium (email address/phone number/webhook user ID, etc.) for this media type must be defined in the user profile. For example, an action sending messages to user "Admin" using webhook "X" will always fail to send anything if the webhook "X" medium is not defined in the user profile.

To define user media:

1. Go to your user profile, or go to *Users* → *Users* and open the user properties form.
2. In the Media tab, click on [Add](#).....

Media ✕

Type Email

* Send to example@company.com [Remove](#)

example recipient <example2@company.com> [Remove](#)

[Add](#)

* When active 1-7,00:00-24:00

Use if severity

- Not classified
- Information
- Warning
- Average
- High
- Disaster

Enabled

Update
Cancel

User media attributes:

Parameter	Description
<i>Type</i>	The drop-down list contains the names of enabled media types. Note that when editing a medium of a disabled media type, the type will be displayed in red.
<i>Send to</i>	Provide required contact information where to send messages. For an email media type it is possible to add several addresses by clicking on Add below the address field. In this case, the notification will be sent to all email addresses provided. It is also possible to specify recipient name in the <i>Send to</i> field of the email recipient in a format 'Recipient name <address1@company.com>'. Note that if a recipient name is provided, an email address should be wrapped in angle brackets (<>). UTF-8 characters in the name are supported, quoted pairs and comments are not. For example: <i>John Abercroft <manager@nycdatcenter.com></i> and <i>manager@nycdatcenter.com</i> are both valid formats. Incorrect examples: <i>John Doe zabbix@company.com</i> , <i>%%"Zabbix @ <H(comment)Q >" zabbix@company.com %%</i> .
<i>When active</i>	You can limit the time when messages are sent, for example, set the working days only (1-5,09:00-18:00). Note that this limit is based on the user time zone . If the user time zone is changed and is different from the system time zone this limit may need to be adjusted accordingly so as not to miss important messages. See the Time period specification page for description of the format.
<i>Use if severity</i>	User macros are supported. Mark the checkboxes of trigger severities that you want to receive notifications for. <i>Note</i> that the default severity ('Not classified') must be checked if you want to receive notifications for non-trigger events . After saving, the selected trigger severities will be displayed in the corresponding severity colors, while unselected ones will be grayed out.
<i>Status</i>	Status of the user media. Enabled - is in use. Disabled - is not being used.

1 Email

Overview

To configure email as the delivery channel for messages, you need to configure email as the media type and assign specific addresses to users.

Note:

Multiple notifications for single event will be grouped together on the same email thread.

Configuration

To configure email as the media type:

1. Go to *Alerts* → *Media types*.
2. Click on *Create media type* (or click on *Email* in the list of pre-defined media types).

The **Media type** tab contains general media type attributes:

New media type ? X

Media type Message templates 5 Options

* Name

Type

Email provider

* SMTP server

SMTP server port

* Email

SMTP helo

Connection security

Authentication

Message format

Description

Enabled

All mandatory input fields are marked with a red asterisk.

The following parameters are specific for the email media type:

Parameter	Description
<i>Email provider</i>	Select the email provider: <i>Generic SMTP</i> , <i>Gmail</i> , <i>Gmail relay</i> , <i>Office365</i> , or <i>Office365 relay</i> . If you select the Gmail/Office365-related options, you will only need to supply the sender email address and password; such options as <i>SMTP server</i> , <i>SMTP server port</i> , <i>SMTP helo</i> , and <i>Connection security</i> will be automatically filled by Zabbix. See also: Automated Gmail/Office365 media types .
<i>SMTP server</i>	Set an SMTP server to handle outgoing messages. This field is available if <i>Generic SMTP</i> is selected as the email provider.

Parameter	Description
<i>SMTP server port</i>	Set the SMTP server port to handle outgoing messages. This field is available if <i>Generic SMTP</i> is selected as the email provider.
<i>Email</i>	The address entered here will be used as the From address for the messages sent. Adding a sender display name (like "Zabbix_info" in <i>Zabbix_info <zabbix@company.com></i> in the screenshot above) with the actual email address is supported. There are some restrictions on display names in Zabbix emails in comparison to what is allowed by RFC 5322, as illustrated by examples: Valid examples: <i>zabbix@company.com</i> (only email address, no need to use angle brackets) <i>Zabbix_info <zabbix@company.com></i> (display name and email address in angle brackets) <i>ΣΩ-monitoring <zabbix@company.com></i> (UTF-8 characters in display name) Invalid examples: <i>Zabbix HQ zabbix@company.com</i> (display name present but no angle brackets around email address) <i>"Zabbix\@ \<H(comment)Q\ >" <zabbix@company.com></i> (although valid by RFC 5322, quoted pairs and comments are not supported in Zabbix emails)
<i>SMTP helo</i>	Set a correct SMTP helo value, normally a domain name. If empty, the domain name of the email will be sent (i.e., what comes after @ in the <i>Email</i> field). If it is impossible to fetch the domain name, a debug-level warning will be logged and the server hostname will be sent as the domain for HELO command. This field is available if <i>Generic SMTP</i> is selected as the email provider.
<i>Connection security</i>	Select the level of connection security: None - do not use the CURLOPT_USE_SSL option STARTTLS - use the CURLOPT_USE_SSL option with CURLUSESSL_ALL value SSL/TLS - use of CURLOPT_USE_SSL is optional
<i>SSL verify peer</i>	Mark the checkbox to verify the SSL certificate of the SMTP server. The value of "SSLCALocation" server configuration directive should be put into CURLOPT_CAPATH for certificate validation.
<i>SSL verify host</i>	This sets cURL option CURLOPT_SSL_VERIFYPEER . Mark the checkbox to verify that the <i>Common Name</i> field or the <i>Subject Alternate Name</i> field of the SMTP server certificate matches. This sets cURL option CURLOPT_SSL_VERIFYHOST .
<i>Authentication</i>	Select the level of authentication: None - no cURL options are set Username and password - implies "AUTH=*" leaving the choice of authentication mechanism to cURL
<i>Username</i>	User name to use in authentication. This sets the value of CURLOPT_USERNAME . User macros supported.
<i>Password</i>	Password to use in authentication. This sets the value of CURLOPT_PASSWORD . User macros supported.
<i>Message format</i>	Select message format: HTML - send as HTML Plain text - send as plain text

Attention:

To enable SMTP authentication options, Zabbix server must be both compiled with the `--with-libcurl` **compilation** option (with cURL 7.20.0 or higher) and use the `libcurl-full` packages during runtime.

See also [common media type parameters](#) for details on how to configure default messages and alert processing options.

Media type testing

To test whether a configured email media type works correctly:

1. Locate the relevant email in the [list](#) of media types.
2. Click on *Test* in the last column of the list (a testing window will open).
3. Enter a *Send to* recipient address, message body and, optionally, subject.
4. Click on *Test* to send a test message.

Test success or failure message will be displayed in the same window:

Test media type "Email"
✕

✓

Media type test successful.

* Send to

Subject

* Message

This is the test message from Zabbix

User media

Once the email media type is configured, go to the *Users* → *Users* section and edit user profile to assign email media to the user. Steps for setting up user media, being common for all media types, are described on the [Media types](#) page.

2 SMS

Overview

Zabbix supports the sending of SMS messages using a serial GSM modem connected to Zabbix server's serial port.

Make sure that:

- The speed of the serial device (normally /dev/ttyS0 under Linux) matches that of the GSM modem. Zabbix does not set the speed of the serial link. It uses default settings.
- The 'zabbix' user has read/write access to the serial device. Run the command `ls -l /dev/ttyS0` to see current permissions of the serial device.
- The GSM modem has PIN entered and it preserves it after power reset. Alternatively you may disable PIN on the SIM card. PIN can be entered by issuing command `AT+CPIN="NNNN"` (NNNN is your PIN number, the quotes must be present) in a terminal software, such as Unix minicom or Windows HyperTerminal.

Zabbix has been tested with these GSM modems:

- Siemens MC35
- Teltonika ModemCOM/G10

To configure SMS as the delivery channel for messages, you also need to configure SMS as the media type and enter the respective phone numbers for the users.

Configuration

To configure SMS as the media type:

- Go to *Alerts* → *Media types*
- Click on *Create media type* (or click on *SMS* in the list of pre-defined media types).

The following parameters are specific for the SMS media type:

Parameter	Description
<i>GSM modem</i>	Set the serial device name of the GSM modem. The path entered here will be validated against the SMSDevices server parameter (if specified).

See [common media type parameters](#) for details on how to configure default messages and alert processing options. Note that parallel processing of sending SMS notifications is not possible.

User media

Once the SMS media type is configured, go to the *Users* → *Users* section and edit user profile to assign SMS media to the user. Steps for setting up user media, being common for all media types, are described on the [Media types](#) page.

3 Custom alert scripts

Overview

If you are not satisfied with the existing media types for sending alerts, there is an alternative way to do that. You can create a script that will handle the notification your way.

Custom alert scripts are executed on Zabbix server. These scripts must be located in the directory specified in the server configuration file `AlertScriptsPath` parameter.

Here is an example of a custom alert script:

```
#####!/bin/bash

to=$1
subject=$2
body=$3
host=$4
value=$5

cat <<EOF | mail -s "$subject" "$to"
$body

Host: $host
Value: $value
EOF
```

Attention:

Zabbix checks for the exit code of the executed commands and scripts. Any exit code, which is different from **0**, is considered as a **command execution** error. In such cases, Zabbix will try to repeat failed execution.

Environment variables are not preserved or created for the script, so they should be handled explicitly.

Configuration

To configure custom alert scripts as a media type:

1. Go to *Alerts* → *Media types*.
2. Click on *Create media type*.

The **Media type** tab contains general media type attributes:

Media type [Message templates](#) [Options](#)

* Name

Type

* Script name

Script parameters ?

Value	Action
<input type="text" value="{ALERT.SENDTO}"/>	Remove
<input type="text" value="{ALERT.SUBJECT}"/>	Remove
<input type="text" value="{ALERT.MESSAGE}"/>	Remove
<input type="text" value="{HOST.HOST}"/>	Remove
<input type="text" value="{ITEM.LASTVALUE}"/>	Remove
Add	

Description

Enabled

All mandatory input fields are marked with a red asterisk.

The following parameters are specific for the script media type:

Parameter	Description
<i>Script name</i>	Enter the name of the script file (e.g., notification.sh) that is located in the directory specified in the server configuration file AlertScriptsPath parameter.
<i>Script parameters</i>	Add optional script parameters that will be passed to the script as command-line arguments in the order in which they are defined.
	Script parameters support {ALERT.SENDTO}, {ALERT.SUBJECT}, {ALERT.MESSAGE} macros, and all macros that are supported in notifications, as well as user macros .

See [common media type parameters](#) for details on how to configure default messages and alert processing options.

Warning:

Even if an alert script does not use default messages, the message templates for operation types used by this media type must still be defined. Otherwise, a notification will not be sent.

Attention:

If more than one script media type is configured, these scripts may be processed in parallel by the alerter processes. The total number of alerter processes is limited by the server configuration file [StartAlerters](#) parameter.

Media type testing

To test a configured script media type:

1. Locate the relevant script in the [list](#) of media types.
2. Click on *Test* in the last column of the list; a testing form will open in a pop-up window. The testing form will contain the same number of parameters that are configured for the script media type.

3. Edit the script parameter values if needed. Editing only affects the test procedure; the actual values will not be changed.
4. Click on *Test*.

Test media type "Notification script" ✕

Script parameters ?

Note:

When testing a configured script media type, {ALERT.SENDTO}, {ALERT.SUBJECT}, {ALERT.MESSAGE} and user macros will resolve to their values, but macros that are related to events (e.g., {HOST.HOST}, {ITEM.LASTVALUE}, etc.) will not resolve, as during testing there is no related event to get the details from. Note that macros within {ALERT.SUBJECT} and {ALERT.MESSAGE} macros will also not resolve. For example, if the value of {ALERT.SUBJECT} is composed of "Problem: {EVENT.NAME}" then the {EVENT.NAME} macro will not be resolved.

User media

Once the media type is configured, go to the *Users* → *Users* section and edit a user profile by assigning this media type to the user. Steps for setting up user media, being common for all media types, are described on the [Media types](#) page.

Note that when defining the user media, the *Send to* field cannot be empty. If this field is not used in the alert script, enter any combination of supported characters to bypass validation requirements.

4 Webhook

Overview

The webhook media type is useful for making HTTP calls using custom JavaScript code for straightforward integration with external software such as helpdesk systems, chats, or messengers. You may choose to import an integration provided by Zabbix or create a custom integration from scratch.

Integrations

The following integrations are available allowing to use predefined webhook media types for pushing Zabbix notifications to:

- [brevis.one](#)
- [Discord](#)
- [Event-Driven Ansible](#)
- [Express.ms messenger](#)
- [Github issues](#)
- [GLPi](#)
- [iLert](#)
- [iTop](#)
- [Jira](#)
- [Jira Service Desk](#)
- [ManageEngine ServiceDesk](#)
- [Mantis Bug Tracker](#)
- [Mattermost](#)
- [Microsoft Teams](#)
- [MS Teams Workflows](#)
- [LINE](#)
- [Opsgenie](#)
- [OTRS](#)
- [Pagerduty](#)
- [Pushover](#)

- [Redmine](#)
- [Rocket.Chat](#)
- [ServiceNow](#)
- [SIGNL4](#)
- [Slack](#)
- [SolarWinds](#)
- [SysAid](#)
- [Telegram](#)
- [TOPdesk](#)
- [VictorOps](#)
- [Zammad](#)
- [Zendesk](#)

Note:

In addition to the services listed here, Zabbix can be integrated with **Spiceworks** (no webhook is required). To convert Zabbix notifications into Spiceworks tickets, create an **email media type** and enter Spiceworks helpdesk email address (e.g. help@zabbix.on.spiceworks.com) in the profile settings of a designated Zabbix user.

Configuration

To start using a webhook integration:

1. Locate required .xml file in the `templates/media` directory of the downloaded Zabbix version or download it from [Zabbix git repository](#).
2. **Import** the file into your Zabbix installation. The webhook will appear in the list of media types.
3. Configure the webhook according to instructions in the *Readme.md* file (you may click on a webhook's name above to quickly access *Readme.md*).

To create a custom webhook from scratch:

1. Go to *Alerts* → *Media types*.
2. Click on *Create media type*.

The **Media type** tab contains various attributes specific for this media type:

New media type ? X

Media type Message templates 5 Options

*** Name**

Type

Parameters	Name	Value	Action
	<input style="width: 150px;" type="text" value="event_source"/>	<input style="width: 150px;" type="text" value="{EVENT.SOURCE}"/>	Remove
	<input style="width: 150px;" type="text" value="event_update_status"/>	<input style="width: 150px;" type="text" value="{EVENT.UPDATE.STATUS}"/>	Remove
	<input style="width: 150px;" type="text" value="event_value"/>	<input style="width: 150px;" type="text" value="{EVENT.VALUE}"/>	Remove
	<input style="width: 150px;" type="text" value="express_message"/>	<input style="width: 150px;" type="text" value="{ALERT.MESSAGE}"/>	Remove
	<input style="width: 150px;" type="text" value="express_send_to"/>	<input style="width: 150px;" type="text" value="{ALERT.SENDTO}"/>	Remove
	<input style="width: 150px;" type="text" value="express_tags"/>	<input style="width: 150px;" type="text" value="{EVENT.TAGSJSON}"/>	Remove
	<input style="width: 150px;" type="text" value="express_token"/>	<input style="width: 150px;" type="text" value="<PLACE BOT TOKEN>"/>	Remove
	<input style="width: 150px;" type="text" value="express_url"/>	<input style="width: 150px;" type="text" value="<PLACE INSTANCE URL>"/>	Remove
	Add		

*** Script**

*** Timeout**

Process tags

Include event menu entry

*** Menu entry name**

*** Menu entry URL**

Description

Enabled

All mandatory input fields are marked with a red asterisk.

The following parameters are specific for the webhook media type:

Parameter	Description
<i>Parameters</i>	<p>Specify the webhook variables as the attribute and value pairs.</p> <p>For preconfigured webhooks, a list of parameters varies, depending on the service. Check the webhook's <i>Readme.md</i> file for parameter description.</p> <p>For new webhooks, several common variables are included by default (URL:<empty>, HTTPProxy:<empty>, To:{ALERT.SENDTO}, Subject:{ALERT.SUBJECT}, Message:{ALERT.MESSAGE}), feel free to keep or remove them.</p> <p>Webhook parameters support user macros, all macros that are supported in problem notifications and, additionally, {ALERT.SENDTO}, {ALERT.SUBJECT}, and {ALERT.MESSAGE} macros.</p> <p>If you specify an HTTP proxy, the field supports the same functionality as in the item configuration HTTP proxy field. The proxy string may be prefixed with [scheme]:// to specify which kind of proxy is used (e.g., https, socks4, socks5; see documentation).</p>
<i>Script</i>	<p>Enter JavaScript code in the modal editor that opens when clicking in the parameter field or on the pencil icon next to it. This code will perform the webhook operation.</p> <p>The script is a function code that accepts parameter - value pairs. The values should be converted into JSON objects using JSON.parse() method, for example: <code>var params = JSON.parse(value);</code>.</p> <p>The code has access to all parameters, it may perform HTTP GET, POST, PUT and DELETE requests and has control over HTTP headers and request body.</p> <p>The script must contain a return operator, otherwise it will not be valid. It may return OK status along with an optional list of tags and tag values (see <i>Process tags</i> option) or an error string.</p> <p>Note that the script is executed only after an alert is created. If the script is configured to return and process tags, these tags will not get resolved in {EVENT.TAGS} and {EVENT.RECOVERY.TAGS} macros in the initial problem message and recovery messages because the script has not had the time to run yet.</p> <p><i>Note:</i> Using local variables instead of global ones is recommended to make sure that each script operates on its own data and that there are no collisions between simultaneous calls (see known issues).</p> <p>See also: Webhook development guidelines, Webhook script examples, Additional JavaScript objects.</p>
<i>Timeout</i>	<p>JavaScript execution timeout (1-60s, default 30s).</p> <p>Time suffixes are supported, e.g., 30s, 1m.</p>
<i>Process tags</i>	<p>Mark the checkbox to process returned JSON property values as tags. These tags are added to any existing problem tags.</p> <p>Note that when using webhook tags, the webhook must return a JSON object containing at least an empty tags object: <code>var result = {tags: {}};</code></p> <p>Examples of tags that can be returned: <i>jira-id:prod-1234, responsible:John Smith, processed:<no value></i></p>
<i>Include event menu entry</i>	<p>Mark the checkbox to include an entry in the event menu linking to a created external ticket. An entry will be included for each webhook that is enabled and has this checkbox marked. Note that if the <i>Menu entry name</i> and <i>Menu entry URL</i> parameters contain any {EVENT.TAGS.<tag name>} macros, an entry will be included only if these macros can be resolved (that is, the event has these tags defined).</p> <p>If marked, the webhook should not be used for sending notifications to different users (consider creating a dedicated user instead) and should not be used in multiple alert actions for a single problem event.</p>
<i>Menu entry name</i>	<p>Specify the menu entry name.</p> <p>{EVENT.TAGS.<tag name>} macro is supported.</p>
<i>Menu entry URL</i>	<p>This field is only mandatory if <i>Include event menu entry</i> is marked.</p> <p>Specify the underlying URL of the menu entry.</p> <p>{EVENT.TAGS.<tag name>} macro is supported.</p> <p>This field is only mandatory if <i>Include event menu entry</i> is marked.</p>

See [common media type parameters](#) for details on how to configure default messages and alert processing options.

Warning:

Even if a webhook doesn't use default messages, message templates for operation types used by this webhook must still be defined.

Media type testing

To test a configured webhook media type:

1. Locate the relevant webhook in the [list](#) of media types.
2. Click on *Test* in the last column of the list (a testing window will open).
3. Edit the webhook parameter values, if needed.
4. Click on *Test*.

By default, webhook tests are performed with parameters entered during configuration. However, it is possible to change attribute values for testing. Replacing or deleting values in the testing window affects the test procedure only, the actual webhook attribute values will remain unchanged.

The screenshot shows a window titled "Test media type 'Telegram webhook'". At the top, a green notification bar with a checkmark icon says "Media type test successful.". Below this, there are input fields for "Message" (containing {ALERT.MESSAGE}), "telegramTOKEN" (containing 1266457374:AAFqF072oyxROyWyAGU9hsf_vqcxvYVmyxl), "To" (containing {ALERT.SENDTO}), and "URL" (containing {\$Zabbix_URL}). A large gray box labeled "Response" contains a JSON object: {"tags": {"key": "MSG-115", "link": "http://example.com/MSG-115"}}. Below the response box, it says "Response type: JSON" and has a blue link "Open log". At the bottom right, there are "Test" and "Cancel" buttons.

To view media type test log entries without leaving the test window, click on *Open log* (a new pop-up window will open).

The screenshot shows a failed test result in the "Test media type Telegram" window. A red notification bar with a warning icon says "Details Media type test failed." and "Sending failed: Bad Request: chat not found.". Below this, the "Message" field contains {ALERT.MESSAGE}. A separate "Media type test log" window is open, showing a log of events:

```
00:00:00.000 [Debug] [Telegram Webhook] URL: https://api.telegram.org/bot<TOKEN>/sendMessage
00:00:00.000 [Debug] [Telegram Webhook] params: {"chat_id":"{ALERT.SENDTO}","text":"{ALERT.SUBJECT}\n{ALERT.MESSAGE}","disable_web_page_preview":true}
00:00:00.139 [Debug] [Telegram Webhook] HTTP code: 400
00:00:00.140 [Debug] [Telegram Webhook] notification failed: Bad Request: chat not found
Time elapsed: 140ms
```

 The log window has an "Ok" button. The main test window also has "Test" and "Cancel" buttons at the bottom right.

If the webhook test is successful:

- "Media type test successful." message is displayed.
- Server response appears in the gray *Response* field.

- Response type (JSON or String) is specified below the *Response* field.

If the webhook test fails:

- “*Media type test failed.*” message is displayed, followed by additional failure details.

User media

Once the media type is configured, go to the *Users* → *Users* section and assign the webhook media to an existing user or create a new user to represent the webhook. Steps for setting up user media for an existing user, being common for all media types, are described on the [Media types](#) page.

If a webhook uses tags to store ticket\message ID, avoid assigning the same webhook as a media to different users as doing so may cause webhook errors (applies to the majority of webhooks that utilize *Include event menu entry* option). In this case, the best practice is to create a dedicated user to represent the webhook:

1. After configuring the webhook media type, go to the *Users* → *Users* section and create a dedicated Zabbix user to represent the webhook - for example, with a username *Slack* for the Slack webhook. All settings, except media, can be left at their defaults as this user will not be logging into Zabbix.
2. In the user profile, go to a tab *Media* and [add a webhook](#) with the required contact information. If the webhook does not use a *Send to* field, enter any combination of supported characters to bypass validation requirements.
3. Grant this user at least read [permissions](#) to all hosts for which it should send the alerts.

When configuring alert action, add this user in the *Send to users* field in Operation details - this will tell Zabbix to use the webhook for notifications from this action.

Configuring alert actions

Actions determine which notifications should be sent via the webhook. Steps for [configuring actions](#) involving webhooks are the same as for all other media types with these exceptions:

- If a webhook uses [webhook tags](#) to store ticket\message ID and handle update\resolve operations, avoid using the same webhook in multiple alert actions for a single problem event. If `{EVENT.TAGS.<tag name>}` exists and gets updated in the webhook, its resulting value will be undefined. To avoid this, use a new tag name in the webhook for storing updated values. This applies to Jira, Jira Service Desk, Mattermost, Opsgenie, OTRS, Redmine, ServiceNow, Slack, Zammad, and Zendesk webhooks provided by Zabbix and to most webhooks utilizing the *Include event menu entry* option. Note, however, that a single webhook can be used in multiple operations or escalation steps of the same action, as well as in different actions that will not be triggered by the same problem event due to different [conditions](#).
- When using a webhook in actions for [internal events](#), ensure to mark the *Custom message* checkbox and define a custom message in the action operation configuration. Otherwise, a notification will not be sent.

1 Webhook script examples

Overview

Though Zabbix offers a large number of webhook integrations available out-of-the-box, you may want to create your own webhooks instead. This section provides examples of custom webhook scripts (used in the *Script* parameter). See [webhook](#) section for description of other webhook parameters.

Jira webhook (custom)

New media type ? X

Media type **Message templates** 5 Options

* Name

Type

Parameters	Name	Value	Action
	<input type="text" value="HTTPProxy"/>	<input type="text"/>	Remove
	<input type="text" value="Message"/>	<input type="text" value="{ALERT.MESSAGE}"/>	Remove
	<input type="text" value="Subject"/>	<input type="text" value="{ALERT.SUBJECT}"/>	Remove
	<input type="text" value="To"/>	<input type="text" value="{ALERT.SENDTO}"/>	Remove
	<input type="text" value="URL"/>	<input type="text"/>	Remove
	Add		

* Script

* Timeout

Process tags

Include event menu entry

* Menu entry name

* Menu entry URL

Description

Enabled

This script will create a JIRA issue and return some info on the created issue.

```
try {
  Zabbix.log(4, '[ Jira webhook ] Started with params: ' + value);

  var result = {
    'tags': {
      'endpoint': 'jira'
    }
  },
  params = JSON.parse(value),
  req = new HttpRequest(),
  fields = {},
  resp;

  if (params.HTTPProxy) {
    req.setProxy(params.HTTPProxy);
  }

  req.addHeader('Content-Type: application/json');
  req.addHeader('Authorization: Basic ' + params.authentication);
}
```

```

fields.summary = params.summary;
fields.description = params.description;
fields.project = {key: params.project_key};
fields.issuetype = {id: params.issue_id};

resp = req.post('https://jira.example.com/rest/api/2/issue/',
  JSON.stringify({"fields": fields})
);

if (req.getStatus() != 201) {
  throw 'Response code: ' + req.getStatus();
}

resp = JSON.parse(resp);
result.tags.issue_id = resp.id;
result.tags.issue_key = resp.key;

return JSON.stringify(result);
}
catch (error) {
  Zabbix.log(4, '[ Jira webhook ] Issue creation failed json : ' + JSON.stringify({"fields": fields}));
  Zabbix.log(3, '[ Jira webhook ] issue creation failed : ' + error);

  throw 'Failed with error: ' + error;
}

```

Slack webhook (custom)

This webhook will forward notifications from Zabbix to a Slack channel.

New media type ? X

[Media type](#) [Message templates](#) [Options](#)

* Name

Type ▾

Parameters	Name	Value	Action
	<input style="width: 90%;" type="text" value="URL"/>	<input style="width: 90%;" type="text"/>	Remove
	<input style="width: 90%;" type="text" value="HTTPProxy"/>	<input style="width: 90%;" type="text"/>	Remove
	<input style="width: 90%;" type="text" value="channel"/>	<input style="width: 90%;" type="text" value="{ALERT.SENDTO}"/>	Remove
	<input style="width: 90%;" type="text" value="text"/>	<input style="width: 90%;" type="text" value="{ALERT.SUBJECT}"/>	Remove
	<input style="width: 90%;" type="text" value="username"/>	<input style="width: 90%;" type="text" value="bot"/>	Remove
	Add		

* Script ↵

```

try {
  var params = JSON.parse(value),
      req = new HttpRequest(),
      response;

  if (params.HTTPProxy) {
    req.setProxy(params.HTTPProxy);
  }

  req.addHeader('Content-Type: application/x-www-form-urlencoded');

  Zabbix.log(4, '[ Slack webhook ] Webhook request with value=' + value);
}

```

```

response = req.post(params.hook_url, 'payload=' + encodeURIComponent(value));
Zabbix.log(4, '[ Slack webhook ] Responded with code: ' + req.getStatus() + '. Response: ' + response);

try {
    response = JSON.parse(response);
}
catch (error) {
    if (req.getStatus() < 200 || req.getStatus() >= 300) {
        throw 'Request failed with status code ' + req.getStatus();
    }
    else {
        throw 'Request success, but response parsing failed.';
    }
}

if (req.getStatus() !== 200 || !response.ok || response.ok === 'false') {
    throw response.error;
}

return 'OK!';
}
catch (error) {
    Zabbix.log(3, '[ Slack webhook ] Sending failed. Error: ' + error);

    throw 'Failed with error: ' + error;
}

```

2 Actions

Overview

If you want some operations taking place as a result of events (for example, notifications sent), you need to configure actions.

Actions can be defined in response to events of all supported types:

- Trigger actions - for events when trigger status changes from *OK* to *PROBLEM* and back
- Service actions - for events when service status changes from *OK* to *PROBLEM* and back
- Discovery actions - for events when network discovery takes place
- Autoregistration actions - for events when new active agents auto-register (or host metadata changes for registered ones)
- Internal actions - for events when items become unsupported or triggers go into an unknown state

The key differences of service actions are:

- User access to service actions depends on access rights to services granted by user's **role**
- Service actions support different set of **conditions**

Configuring an action

To configure an action, do the following:

- Go to *Alerts* → *Actions* and select the required action type from the submenu (you can switch to another type later, using the title dropdown)
- Click on *Create action*
- Name the action
- Choose **conditions** upon which operations are carried out
- Choose the **operations** to carry out

General action attributes:

New action
? X

Action
Operations

* Name

Type of calculation And A and B

Conditions	Label	Name	Action
	A	Trigger severity is greater than or equals <i>Not classified</i>	Remove
	B	Trigger severity does not equal <i>Information</i>	Remove
	Add		

Enabled

* At least one operation must exist.

Add
Cancel

All mandatory input fields are marked with a red asterisk.

Parameter	Description
<i>Name</i>	Unique action name.
<i>Type of calculation</i>	Select the evaluation option for action conditions (with more than one condition): And - all conditions must be met. Or - enough if one condition is met. And/Or - combination of the two: AND with different condition types and OR with the same condition type. Custom expression - a user-defined calculation formula for evaluating action conditions.
<i>Conditions</i>	List of action conditions. Click on <i>Add</i> to add a new condition . If no conditions are configured, the action will run for every event that corresponds to the action type being configured.
<i>Enabled</i>	Mark the checkbox to enable the action. Otherwise, it will be disabled.

1 Conditions

Overview

It is possible to define that an action is executed only if the event matches a defined set of conditions. Conditions are set when configuring the **action**.

Condition matching is case-sensitive.

Trigger actions

The following conditions can be used in trigger-based actions:

Condition type	Supported operators	Description
<i>Host group</i>	equals	Specify host groups or host groups to exclude.
	does not equal	equals - event belongs to this host group. does not equal - event does not belong to this host group. Specifying a parent host group implicitly selects all nested host groups. To specify the parent group only, all nested groups have to be additionally set with the does not equal operator.

Condition type	Supported operators	Description
<i>Template</i>	equals	Specify templates or templates to exclude.
	does not equal	equals - event belongs to a trigger inherited from this template. does not equal - event does not belong to a trigger inherited from this template.
<i>Host</i>	equals	Specify hosts or hosts to exclude.
	does not equal	equals - event belongs to this host. does not equal - event does not belong to this host.
<i>Tag name</i>	equals	Specify event tag or event tag to exclude.
	does not equal	equals - event has this tag.
	contains	does not equal - event does not have this tag.
	does not contain	contains - event has a tag containing this string. does not contain - event does not have a tag containing this string.
<i>Tag value</i>	equals	Specify event tag and value combination or tag and value combination to exclude.
	does not equal	equals - event has this tag and value.
	contains	does not equal - event does not have this tag and value.
	does not contain	contains - event has a tag and value containing these strings. does not contain - event does not have a tag and value containing these strings.
<i>Trigger</i>	equals	Specify triggers or triggers to exclude.
	does not equal	equals - event is generated by this trigger. does not equal - event is generated by any other trigger, except this one.
<i>Event name</i>	contains	Specify a string in the name of the event generated by the trigger or a string to exclude. By default, the event name matches the trigger name unless a custom event name is specified in trigger configuration .
	does not contain	contains - event name contains this string. does not contain - this string is excluded from the event name. Note: Entered value will be compared to event name with all macros expanded.
<i>Trigger severity</i>	equals	Specify trigger severity.
	does not equal	equals - equal to trigger severity.
	is greater than or equals	does not equal - not equal to trigger severity.
	is less than or equals	is greater than or equals - more or equal to trigger severity. is less than or equals - less or equal to trigger severity.
<i>Time period</i>	in	Specify a time period or a time period to exclude.
	not in	in - event time is within the time period. not in - event time is not within the time period. See the time period specification page for description of the format. User macros are supported.
<i>Problem is suppressed</i>	no	Specify if the problem is suppressed (not shown) because of host maintenance.
	yes	no - problem is not suppressed. yes - problem is suppressed.

Service actions

The following conditions can be used in service actions:

Condition type	Supported operators	Description
<i>Service</i>	equals	Specify a service or a service to exclude.
	does not equal	equals - event belongs to this service. does not equal - event does not belong to this service. Specifying a parent service implicitly selects all child services. To specify the parent service only, all nested services have to be additionally set with the does not equal operator.

Condition type	Supported operators	Description
<i>Service name</i>	contains	Specify a string in the service name or a string to exclude.
	does not contain	contains - event is generated by a service, containing this string in the name. does not contain - this string cannot be found in the service name.
<i>Service tag name</i>	equals	Specify an event tag or an event tag to exclude. Service event tags can be defined in the service configuration section <i>Tags</i> .
	does not equal	equals - event has this tag.
	contains	does not equal - event does not have this tag.
	does not contain	contains - event has a tag containing this string. does not contain - event does not have a tag containing this string.
<i>Service tag value</i>	equals	Specify an event tag and value combination or a tag and value combination to exclude. Service event tags can be defined in the service configuration section <i>Tags</i> .
	does not equal	equals - event has this tag and value.
	contains	does not equal - event does not have this tag and value.
	does not contain	contains - event has a tag and value containing these strings. does not contain - event does not have a tag and value containing these strings.

Attention:

Make sure to define **message templates** for Service actions in the *Alerts* → *Media types* menu. Otherwise, the notifications will not be sent.

Discovery actions

The following conditions can be used in discovery-based events:

Condition type	Supported operators	Description
<i>Host IP</i>	equals	Specify an IP address range or a range to exclude for a discovered host.
	does not equal	equals - host IP is in the range. does not equal - host IP is not in the range. It may have the following formats: Single IP: 192.168.1.33 Range of IP addresses: 192.168.1-10.1-254 IP mask: 192.168.4.0/24 List: 192.168.1.1-254, 192.168.2.1-100, 192.168.2.200, 192.168.4.0/24 Spaces in the list format are supported.
<i>Service type</i>	equals	Specify a service type of a discovered service or a service type to exclude.
	does not equal	equals - matches the discovered service. does not equal - does not match the discovered service. Available service types: SSH, LDAP, SMTP, FTP, HTTP, HTTPS, POP, NNTP, IMAP, TCP, Zabbix agent, SNMPv1 agent, SNMPv2 agent, SNMPv3 agent, ICMP ping, telnet.
<i>Service port</i>	equals	Specify a TCP port range of a discovered service or a range to exclude.
	does not equal	equals - service port is in the range. does not equal - service port is not in the range.
<i>Discovery rule</i>	equals	Specify a discovery rule or a discovery rule to exclude.
	does not equal	equals - using this discovery rule. does not equal - using any other discovery rule, except this one.
<i>Discovery check</i>	equals	Specify a discovery check or a discovery check to exclude.
	does not equal	equals - using this discovery check. does not equal - using any other discovery check, except this one.
<i>Discovery object</i>	equals	Specify the discovered object. equals - equal to discovered object (a device or a service).

Condition type	Supported operators	Description
<i>Discovery status</i>	equals	Up - matches 'Host Up' and 'Service Up' events. Down - matches 'Host Down' and 'Service Down' events. Discovered - matches 'Host Discovered' and 'Service Discovered' events. Lost - matches 'Host Lost' and 'Service Lost' events.
<i>Uptime/Downtime</i>	is greater than or equals is less than or equals	Uptime for 'Host Up' and 'Service Up' events. Downtime for 'Host Down' and 'Service Down' events. is greater than or equals - is more or equal to. Parameter is given in seconds. is less than or equals - is less or equal to. Parameter is given in seconds.
<i>Received value</i>	equals does not equal is greater than or equals is less than or equals contains does not contain	Specify the value received from an agent (Zabbix, SNMP) check in a discovery rule. String comparison. If several Zabbix agent or SNMP checks are configured for a rule, received values for each of them are checked (each check generates a new event which is matched against all conditions). equals - equal to the value. does not equal - not equal to the value. is greater than or equals - more or equal to the value. is less than or equals - less or equal to the value. contains - contains the substring. Parameter is given as a string. does not contain - does not contain the substring. Parameter is given as a string.
<i>Proxy</i>	equals does not equal	Specify a proxy or a proxy to exclude. equals - using this proxy. does not equal - using any other proxy except this one.

Note:

Service checks in a discovery rule, which result in discovery events, do not take place simultaneously. Therefore, if **multiple** values are configured for *Service type*, *Service port* or *Received value* conditions in the action, they will be compared to one discovery event at a time, but **not** to several events simultaneously. As a result, actions with multiple values for the same check types may not be executed correctly.

Autoregistration actions

The following conditions can be used in actions based on active agent autoregistration:

Condition type	Supported operators	Description
<i>Host metadata</i>	contains does not contain matches does not match	Specify host metadata or host metadata to exclude. contains - host metadata contains the string. does not contain - host metadata does not contain the string. Host metadata can be specified in an agent configuration file . matches - host metadata matches regular expression. does not match - host metadata does not match regular expression.
<i>Host name</i>	contains does not contain matches does not match	Specify a host name or a host name to exclude. contains - host name contains the string. does not contain - host name does not contain the string. matches - host name matches regular expression. does not match - host name does not match regular expression.
<i>Proxy</i>	equals does not equal	Specify a proxy or a proxy to exclude. equals - using this proxy. does not equal - using any other proxy except this one.

Internal event actions

The following conditions can be set for actions based on internal events:

Condition type	Supported operators	Description
<i>Event type</i>	equals	Item in "not supported" state - matches events where an item goes from a 'normal' to 'not supported' state. Low-level discovery rule in "not supported" state - matches events where a low-level discovery rule goes from a 'normal' to 'not supported' state. Trigger in "unknown" state - matches events where a trigger goes from a 'normal' to 'unknown' state.
<i>Host group</i>	equals	Specify host groups or host groups to exclude.
	does not equal	equals - event belongs to this host group. does not equal - event does not belong to this host group.
<i>Tag name</i>	equals	Specify event tag or event tag to exclude.
	does not equal	equals - event has this tag.
	contains	does not equal - event does not have this tag.
	does not contain	contains - event has a tag containing this string. does not contain - event does not have a tag containing this string.
<i>Tag value</i>	equals	Specify event tag and value combination or tag and value combination to exclude.
	does not equal	equals - event has this tag and value.
	contains	does not equal - event does not have this tag and value.
	does not contain	contains - event has a tag and value containing these strings. does not contain - event does not have a tag and value containing these strings.
<i>Template</i>	equals	Specify templates or templates to exclude.
	does not equal	equals - event belongs to an item/trigger/low-level discovery rule inherited from this template. does not equal - event does not belong to an item/trigger/low-level discovery rule inherited from this template.
<i>Host</i>	equals	Specify hosts or hosts to exclude.
	does not equal	equals - event belongs to this host. does not equal - event does not belong to this host.

Type of calculation

The following options of calculating conditions are available:

- **And** - all conditions must be met

Note that using "And" calculation is disallowed between several triggers when they are selected as a Trigger= condition. Actions can only be executed based on the event of one trigger.

- **Or** - enough if one condition is met
- **And/Or** - combination of the two: AND with different condition types and OR with the same condition type, for example:

Host group equals Oracle servers
Host group equals MySQL servers
Event name contains 'Database is down'
Event name contains 'Database is unavailable'

is evaluated as

(Host group equals Oracle servers or Host group equals MySQL servers) and (Event name contains 'Database is down' or Event name contains 'Database is unavailable')

- **Custom expression** - a user-defined calculation formula for evaluating action conditions. It must include all conditions (represented as uppercase letters A, B, C, ...) and may include spaces, tabs, brackets (), **and** (case sensitive), **or** (case sensitive), **not** (case sensitive).

While the previous example with And/Or would be represented as (A or B) and (C or D), in a custom expression you may as well have multiple other ways of calculation:

(A and B) and (C or D)
(A and B) or (C and D)
((A or B) and C) or D
(not (A or B) and C) or not D
etc.

Actions disabled due to deleted objects

If a certain object (host, template, trigger, etc.) used in an action condition/operation is deleted, the condition/operation is removed and the action is disabled to avoid incorrect execution of the action. The action can be re-enabled by the user.

This behavior takes place when deleting:

- host groups ("host group" condition, "remote command" operation on a specific host group);
- hosts ("host" condition, "remote command" operation on a specific host);
- templates ("template" condition, "link template" and "unlink template" operations);
- triggers ("trigger" condition);
- discovery rules (when using "discovery rule" and "discovery check" conditions).

Note:

If a remote command has many target hosts, and we delete one of them, only this host will be removed from the target list, the operation itself will remain. But, if it's the only host, the operation will be removed, too. The same goes for "link template" and "unlink template" operations.

Actions are not disabled when deleting a user or user group used in a "send message" operation.

2 Operations

Overview

You can define the following operations for all events:

- Send a message
- Execute a remote command

Attention:

Zabbix server does not create alerts if access to the host is explicitly "denied" for the user defined as action operation recipient or if the user has no rights defined to the host at all.

For discovery and autoregistration events, additional operations are available:

- **Add host**
- Remove host
- Enable host
- Disable host
- Add to host group
- Remove from host group
- Add host tags
- Remove host tags
- Link template
- Unlink template
- Set host inventory mode

Configuring an operation

To configure an operation, go to the *Operations* tab in **action** configuration.

Action
? ×

Action Operations 4

* Default operation step duration

	Steps	Start in	Duration	Actions																				
Operations	<table border="1" style="width: 100%; border-collapse: collapse;"> <thead> <tr> <th style="width: 5%;"></th> <th style="width: 55%;">Details</th> <th style="width: 10%;">Start in</th> <th style="width: 10%;">Duration</th> <th style="width: 10%;">Actions</th> </tr> </thead> <tbody> <tr> <td>1</td> <td>Send message to user groups: Zabbix administrators via Email</td> <td>Immediately</td> <td>Default</td> <td>Edit Remove</td> </tr> <tr> <td colspan="5">Add</td> </tr> </tbody> </table>		Details	Start in	Duration	Actions	1	Send message to user groups: Zabbix administrators via Email	Immediately	Default	Edit Remove	Add												
	Details	Start in	Duration	Actions																				
1	Send message to user groups: Zabbix administrators via Email	Immediately	Default	Edit Remove																				
Add																								
Recovery operations	<table border="1" style="width: 100%; border-collapse: collapse;"> <thead> <tr> <th style="width: 5%;"></th> <th style="width: 60%;">Details</th> <th style="width: 10%;">Start in</th> <th style="width: 10%;">Duration</th> <th style="width: 10%;">Actions</th> </tr> </thead> <tbody> <tr> <td></td> <td>Notify all involved</td> <td></td> <td></td> <td>Edit Remove</td> </tr> <tr> <td colspan="5">Add</td> </tr> </tbody> </table>		Details	Start in	Duration	Actions		Notify all involved			Edit Remove	Add												
	Details	Start in	Duration	Actions																				
	Notify all involved			Edit Remove																				
Add																								
Update operations	<table border="1" style="width: 100%; border-collapse: collapse;"> <thead> <tr> <th style="width: 5%;"></th> <th style="width: 60%;">Details</th> <th style="width: 10%;">Start in</th> <th style="width: 10%;">Duration</th> <th style="width: 10%;">Actions</th> </tr> </thead> <tbody> <tr> <td></td> <td>Send message to user groups: Zabbix administrators via SMS</td> <td></td> <td></td> <td>Edit Remove</td> </tr> <tr> <td></td> <td>Notify all involved</td> <td></td> <td></td> <td>Edit Remove</td> </tr> <tr> <td colspan="5">Add</td> </tr> </tbody> </table>		Details	Start in	Duration	Actions		Send message to user groups: Zabbix administrators via SMS			Edit Remove		Notify all involved			Edit Remove	Add							
	Details	Start in	Duration	Actions																				
	Send message to user groups: Zabbix administrators via SMS			Edit Remove																				
	Notify all involved			Edit Remove																				
Add																								

Pause operations for symptom problems

Pause operations for suppressed problems

Notify about canceled escalations

* At least one operation must exist.

General operation attributes:

Parameter	Description
<i>Default operation step duration</i>	Duration of one operation step by default (60 seconds to 1 week). For example, an hour-long step duration means that if an operation is carried out, an hour will pass before the next step. Time suffixes are supported, e.g. 60s, 1m, 2h, 1d. User macros are supported.
<i>Operations</i>	Action operations (if any) are displayed, with these details: Steps - escalation step(s) to which the operation is assigned. Details - type of operation and its recipient/target. The operation list also displays the media type (email, SMS or script) used as well as the name and surname (in parentheses after the username) of a notification recipient. Start in - how long after an event the operation is performed. Duration (sec) - step duration is displayed. <i>Default</i> is displayed if the step uses default duration, and a time is displayed if custom duration is used. Actions - links for editing and removing an operation are displayed.
<i>Recovery operations</i>	Action operations (if any) are displayed, with these details: Details - type of operation and its recipient/target. The operation list also displays the media type (email, SMS or script) used as well as the name and surname (in parentheses after the username) of a notification recipient. Actions - links for editing and removing an operation are displayed.
<i>Update operations</i>	Action operations (if any) are displayed, with these details: Details - type of operation and its recipient/target. The operation list also displays the media type (email, SMS or script) used as well as the name and surname (in parentheses after the username) of a notification recipient. Actions - links for editing and removing an operation are displayed.
<i>Pause operations for symptom problems</i>	Mark this checkbox to pause operations (after the first operation) for symptom problems. Note that this setting affects only problem escalations; recovery and update operations will not be affected. This option is available for <i>Trigger actions</i> only.
<i>Pause operations for suppressed problems</i>	Mark this checkbox to delay the start of operations for the duration of a maintenance period. When operations are started, after the maintenance, all operations are performed including those for the events during the maintenance. Note that this setting affects only problem escalations; recovery and update operations will not be affected. If you unmark this checkbox, operations will be executed without delay even during a maintenance period. This option is not available for <i>Service actions</i> .

Parameter	Description
<i>Notify about canceled escalations</i>	Unmark this checkbox to disable notifications about canceled escalations (when host, item, trigger or action is disabled).

All mandatory input fields are marked with a red asterisk.

To configure details of a new operation, click on [Add](#) in the *Operations* block. To edit an existing operation, click on [Edit](#) next to the operation. A pop-up window will open where you can edit the operation step details.

Operation details

Operation details ✕

Operation **Send message**

Steps - (0 - infinitely)

Step duration (0 - use action default)

*** At least one user or user group must be selected.**

Send to user groups
type here to search

Send to users

Send to media type

Custom message

Conditions	Label	Name	Action
	A	Event is not acknowledged	Remove
	Add		

Parameter	Description
<i>Operation</i>	Select the operation: Send message - send message to user. <remote command name> - execute a remote command. Commands are available for execution if previously defined in global scripts with <i>Action operation</i> selected as its scope. More operations are available for discovery and autoregistration based events (see above).
<i>Steps</i>	Select the step(s) to assign the operation to in an escalation schedule: From - execute starting with this step. To - execute until this step (0=infinity, execution will not be limited).
<i>Step duration</i>	Custom duration for these steps (0=use default step duration). Time suffixes are supported, e.g. 60s, 1m, 2h, 1d. User macros are supported.
	Several operations can be assigned to the same step. If these operations have different step duration defined, the shortest one is taken into account and applied to the step.

Parameter	Description
Operation type: send message	
Send to user groups	Select user groups to send the message to. The user group must have at least "read" permissions to the host in order to be notified.
Send to users	Select users to send the message to. The user must have at least "read" permissions to the host in order to be notified.
Send to media type	Send message to all available (configured and enabled) media types or a specific one only.
Custom message	If selected, the custom message can be configured. For notifications about internal events via webhooks , custom message is mandatory.
Subject	Subject of the custom message. The subject may contain macros. It is limited to 255 characters.
Message	The custom message. The message may contain macros. It is limited to certain amount of characters depending on the type of database (see Sending message for more information).
Operation type: re-mote command	
Target list	Select targets to execute the command on: Current host - command is executed on the host of the trigger that caused the problem event. This option will not work if there are multiple hosts in the trigger. Host - select host(s) to execute the command on. Host group - select host group(s) to execute the command on. Specifying a parent host group implicitly selects all nested host groups. Thus the remote command will also be executed on hosts from nested groups. A command on a host is executed only once, even if the host matches more than once (e.g. from several host groups; individually and from a host group). The target list is meaningless if a custom script is executed on Zabbix server. Selecting more targets in this case only results in the script being executed on the server more times. Note that for global scripts, the target selection also depends on the <i>Host group</i> setting in global script configuration . <i>Target list</i> option is not available for <i>Service actions</i> because in this case remote commands are always executed on Zabbix server.
Conditions	Condition for performing the operation: Event is not acknowledged - only when the event is unacknowledged. Event is acknowledged - only when the event is acknowledged. <i>Conditions</i> option is only available for <i>Trigger actions</i> .

When done, click *Add* to add the operation to the list of *Operations*.

1 Sending message

Overview

Sending a message is one of the best ways of notifying people about a problem. That is why it is one of the primary actions offered by Zabbix.

Configuration

To be able to send and receive notifications from Zabbix you have to:

- **define the media** to send a message to

If the operation takes place outside of the **When active** time period defined for the selected media in the user configuration, the message will not be sent.

The default trigger severity ('Not classified') **must be** checked in user media **configuration** if you want to receive notifications for non-trigger events such as discovery, active agent autoregistration or internal events.

- **configure an action operation** that sends a message to one of the defined media

Attention:

Zabbix sends notifications only to those users that have at least 'read' permissions to the host that generated the event. At least one host of a trigger expression must be accessible.

You can configure custom scenarios for sending messages using **escalations**.

To successfully receive and read emails from Zabbix, email servers/clients must support standard 'SMTP/MIME email' format since Zabbix sends UTF-8 data (If the subject contains ASCII characters only, it is not UTF-8 encoded.). The subject and the body of the message are base64-encoded to follow 'SMTP/MIME email' format standard.

Message limit after all macros expansion is the same as message limit for **Remote commands**.

Tracking messages

You can view the status of messages sent in *Monitoring* → *Problems*.

In the *Actions* column you can see summarized information about actions taken. In there green numbers represent messages sent, red ones - failed messages. *In progress* indicates that an action is initiated. *Failed* informs that no action has executed successfully.

If you click on the event time to view event details, you will be able to see details of messages sent (or not sent) due to the event in the *Actions* block.

In *Reports* → *Action log* you will see details of all actions taken for those events that have an action configured.

2 Remote commands

Overview

With remote commands you can define that a certain pre-defined command is automatically executed on the monitored host upon some condition.

Thus remote commands are a powerful mechanism for smart pro-active monitoring.

In the most obvious uses of the feature you can try to:

- Automatically restart some application (web server, middleware, CRM) if it does not respond
- Use IPMI 'reboot' command to reboot some remote server if it does not answer requests
- Automatically free disk space (removing older files, cleaning /tmp) if running out of disk space
- Migrate a VM from one physical box to another depending on the CPU load
- Add new nodes to a cloud environment upon insufficient CPU (disk, memory, whatever) resources

Configuring an action for remote commands is similar to that for sending a message, the only difference being that Zabbix will execute a command instead of sending a message.

Remote commands can be executed by Zabbix server, proxy or agent. Remote commands on Zabbix agent can be executed directly by Zabbix server or through Zabbix proxy. Both on Zabbix agent and Zabbix proxy remote commands are disabled by default. They can be enabled by:

- adding an `AllowKey=system.run[*]` parameter in agent configuration;
- setting the `EnableRemoteCommands` parameter to '1' in proxy configuration.

Remote commands executed by Zabbix server are run as described in **Command execution** including exit code checking.

Remote commands are executed even if the target host is in maintenance.

Remote command limit

Remote command limit after resolving all macros depends on the type of database and character set (non-ASCII characters require more than one byte to be stored):

Database	Limit in characters	Limit in bytes
MySQL	65535	65535
PostgreSQL	65535	not limited
SQLite (only Zabbix proxy)	65535	not limited

Remote command execution output (return value) is limited to 16MB (including trailing whitespace that is truncated). **IPMI remote command** limit is based on the installed IPMI library. Note that **database limits** apply to all remote commands.

Configuration

Those remote commands that are executed on Zabbix agent (custom scripts) must be first enabled in the agent **configuration**.

Make sure that the `AllowKey=system.run[<command>,*]` parameter is added for each allowed command in agent configuration to allow specific command with `nowait` mode. Restart agent daemon if changing this parameter.

Then, when configuring a new action in *Alerts* → *Actions* → *Trigger actions*:

1. Define the appropriate conditions, for example, set that the action is activated upon any disaster problems with one of Apache applications.

New action
? X

Action

Operations

* Name

Type of calculation And A and B and C

Conditions	Label	Name	Action
	A	Problem is not suppressed	Remove
	B	Value of tag <i>Application</i> contains <i>Apache</i>	Remove
	C	Trigger severity is greater than or equals <i>Disaster</i>	Remove
	Add		

Enabled

* At least one operation must exist.

Add
Cancel

2. In the *Operations* tab, click on *Add* in the *Operations*, *Recovery operations*, or *Update operations* block.

New action ? X

Action Operations

* Default operation step duration

Operations	Steps	Details	Start in	Duration	Action
	Add				

Recovery operations Details Action
[Add](#)

Update operations Details Action
[Add](#)

Pause operations for suppressed problems

Notify about canceled escalations

* At least one operation must exist.

[Add](#) [Cancel](#)

3. Select one of the predefined scripts from the *Operation* dropdown list and set the *Target list* for the script.

Operation details X

Operation

Steps (0 - infinitely)

Step duration (0 - use action default)

* Target list

Current host

Hosts [Select](#)

Host groups [Select](#)

Conditions	Label	Name	Action
	Add		

[Add](#) [Cancel](#)

Predefined scripts

Scripts that are available for action operations (webhook, script, SSH, Telnet, IPMI) are defined in **global scripts**.

For example:

```
sudo /etc/init.d/apache restart
```

In this case, Zabbix will try to restart an Apache process. With this command, make sure that the command is executed on Zabbix agent (click the *Zabbix agent* button against *Execute on*).

Attention:
 Note the use of **sudo** - Zabbix user does not have permissions to restart system services by default. See below for hints on how to configure **sudo**.

Note:

Starting with Zabbix agent 7.0, remote commands can also be executed on an agent that is operating in active mode. Zabbix agent - whether active or passive - should run on the remote host, and executes the commands in background.

Remote commands on Zabbix agent are executed without timeout by the `system.run[,nowait]` key and are not checked for execution results. On Zabbix server and Zabbix proxy, remote commands are executed with timeout as set in the `TrapperTimeout` parameter of `zabbix_server.conf` or `zabbix_proxy.conf` file and are **checked** for execution results. For additional information, see *Script timeout*.

Access permissions

Make sure that the 'zabbix' user has execute permissions for configured commands. One may be interested in using **sudo** to give access to privileged commands. To configure access, execute as root:

```
visudo
```

Example lines that could be used in *sudoers* file:

```
# allows 'zabbix' user to run all commands without password.
zabbix ALL=NOPASSWD: ALL
```

```
# allows 'zabbix' user to restart apache without password.
zabbix ALL=NOPASSWD: /etc/init.d/apache restart
```

Note:

On some systems *sudoers* file will prevent non-local users from executing commands. To change this, comment out **requiretty** option in */etc/sudoers*.

Remote commands with multiple interfaces

If the target system has multiple interfaces of the selected type (Zabbix agent or IPMI), remote commands will be executed on the default interface.

It is possible to execute remote commands via SSH and Telnet using another interface than the Zabbix agent one. The available interface to use is selected in the following order:

- Zabbix agent default interface
- SNMP default interface
- JMX default interface
- IPMI default interface

IPMI remote commands

For IPMI remote commands the following syntax should be used:

```
<command> [<value>]
```

where

- <command> - one of IPMI commands without spaces
- <value> - 'on', 'off' or any unsigned integer. <value> is an optional parameter.

Examples

Examples of **global scripts** that may be used as remote commands in action operations.

Example 1

Restart of Windows on certain condition.

In order to automatically restart Windows upon a problem detected by Zabbix, define the following script:

Script parameter	Value
<i>Scope</i>	'Action operation'
<i>Type</i>	'Script'
<i>Command</i>	c:\windows\system32\shutdown.exe -r -f

Example 2

Restart the host by using IPMI control.

Script parameter	Value
<i>Scope</i>	'Action operation'
<i>Type</i>	'IPMI'
<i>Command</i>	reset

Example 3

Power off the host by using IPMI control.

Script parameter	Value
<i>Scope</i>	'Action operation'
<i>Type</i>	'IPMI'
<i>Command</i>	power off

3 Additional operations

Overview

In this section you may find some details of **additional operations** for discovery/autoregistration events.

Adding host

Hosts are added during the discovery process, as soon as a host is discovered, rather than at the end of the discovery process.

Note:

As network discovery can take some time due to many unavailable hosts/services having patience and using reasonable IP ranges is advisable.

When adding a host, its name is decided by the standard **gethostbyname** function. If the host can be resolved, resolved name is used. If not, the IP address is used. Besides, if IPv6 address must be used for a host name, then all ":" (colons) are replaced by "_" (underscores), since colons are not allowed in host names.

Attention:

If performing discovery by a proxy, currently hostname lookup still takes place on Zabbix server.

Attention:

If a host already exists in Zabbix configuration with the same name as a newly discovered one, Zabbix will add **_N** to the hostname, where **N** is increasing number, starting with 2.

4 Using macros in messages

Overview

In message subjects and message text you can use macros for more efficient problem reporting.

In addition to a number of built-in macros, **user macros** and **expression macros** are also supported. A **full list of macros** supported by Zabbix is available.

Examples

Examples here illustrate how you can use macros in messages.

Example 1

Message subject:

Problem: {TRIGGER.NAME}

When you receive the message, the message subject will be replaced by something like:

Problem: Processor load is too high on Zabbix server

Example 2

Message:

Processor load is: `{?last(/zabbix.zabbix.com/system.cpu.load[,avg1])}`

When you receive the message, the message will be replaced by something like:

Processor load is: 1.45

Example 3

Message:

Latest value: `{?last(/{HOST.HOST}/{ITEM.KEY})}`

MAX for 15 minutes: `{?max(/{HOST.HOST}/{ITEM.KEY},15m)}`

MIN for 15 minutes: `{?min(/{HOST.HOST}/{ITEM.KEY},15m)}`

When you receive the message, the message will be replaced by something like:

Latest value: 1.45

MAX for 15 minutes: 2.33

MIN for 15 minutes: 1.01

Example 4

Message:

`http://<server_ip_or_name>/zabbix/tr_events.php?triggerid={TRIGGER.ID}&eventid={EVENT.ID}`

When you receive the message, it will contain a link to the *Event details* page, which provides information about the event, its trigger, and a list of latest events generated by the same trigger.

Example 5

Informing about values from several hosts in a trigger expression.

Message:

Problem name: `{TRIGGER.NAME}`

Trigger expression: `{TRIGGER.EXPRESSION}`

1. Item value on `{HOST.NAME1}`: `{ITEM.VALUE1}` (`{ITEM.NAME1}`)

2. Item value on `{HOST.NAME2}`: `{ITEM.VALUE2}` (`{ITEM.NAME2}`)

When you receive the message, the message will be replaced by something like:

Problem name: Processor load is too high on a local host

Trigger expression: `last(/Myhost/system.cpu.load[percpu,avg1])>5` or `last(/Myotherhost/system.cpu.load[percpu,avg1])>5`

1. Item value on Myhost: 0.83 (Processor load (1 min average per core))

2. Item value on Myotherhost: 5.125 (Processor load (1 min average per core))

Example 6

Receiving details of both the problem event and recovery event in a **recovery** message:

Message:

Problem:

Event ID: `{EVENT.ID}`

Event value: `{EVENT.VALUE}`

Event status: `{EVENT.STATUS}`

Event time: `{EVENT.TIME}`

Event date: `{EVENT.DATE}`

Event age: `{EVENT.AGE}`

Event acknowledgment: `{EVENT.ACK.STATUS}`

Event update history: `{EVENT.UPDATE.HISTORY}`

Recovery:

Event ID: `{EVENT.RECOVERY.ID}`

Event value: `{EVENT.RECOVERY.VALUE}`

Event status: {EVENT.RECOVERY.STATUS}
Event time: {EVENT.RECOVERY.TIME}
Event date: {EVENT.RECOVERY.DATE}
Operational data: {EVENT.OPDATA}

When you receive the message, the macros will be replaced by something like:

Problem:

Event ID: 21874
Event value: 1
Event status: PROBLEM
Event time: 13:04:30
Event date: 2018.01.02
Event age: 5m
Event acknowledgment: Yes
Event update history: 2018.01.02 13:05:51 "John Smith (Admin)"
Actions: acknowledged.

Recovery:

Event ID: 21896
Event value: 0
Event status: OK
Event time: 13:10:07
Event date: 2018.01.02
Operational data: Current value is 0.83

3 Recovery operations

Overview

Recovery operations allow you to be notified when problems are resolved.

Both messages and remote commands are supported in recovery operations. While several operations can be added, escalation is not supported - all operations are assigned to a single step and therefore will be performed simultaneously.

Use cases

Some use cases for recovery operations are as follows:

1. Notify on a recovery all users that were notified on the problem:
 - Select *Notify all involved* as operation type.
2. Have multiple operations upon recovery: send a notification and execute a remote command:
 - Add operation types for sending a message and executing a command.
3. Open a ticket in external helpdesk/ticketing system and close it when the problem is resolved:
 - Create an external script that communicates with the helpdesk system.
 - Create an action having operation that executes this script and thus opens a ticket.
 - Have a recovery operation that executes this script with other parameters and closes the ticket.
 - Use the {EVENT.ID} macro to reference the original problem.

Configuring a recovery operation

To configure a recovery operation, go to the *Operations* tab in **action** configuration.

New action ? x

Action **Operations 4**

* Default operation step duration

Operations	Steps	Details	Start in	Duration	Action
	1	Send message to user groups: Zabbix administrators via Email	Immediately	Default	Edit Remove
Add					

Recovery operations	Details	Action
	Notify all involved	Edit Remove
Add		

Update operations	Details	Action
	Send message to user groups: Zabbix administrators via SMS	Edit Remove
	Notify all involved	Edit Remove
Add		

Pause operations for suppressed problems

Notify about canceled escalations

* At least one operation must exist.

[Add](#) [Cancel](#)

To configure details of a new recovery operation, click on [Add](#) in the *Recovery operations* block. To edit an existing operation, click on [Edit](#) next to the operation. A pop-up window will open where you can edit the operation step details.

Recovery operation details

Operation details x

Operation

Custom message

Subject

Message

[Add](#) [Cancel](#)

Three operation types are available for recovery events:

- **Send message** - send recovery message to specified user;
- **Notify all involved** - send recovery message to all users who were notified on the problem event;
- **<remote command name>** - execute a remote command. Commands are available for execution if previously defined in [global scripts](#) with *Action operation* selected as its scope.

Parameters for each operation type are described below. All mandatory input fields are marked with a red asterisk. When done, click on *Add* to add operation to the list of *Recovery operations*.

Note:

Note that if the same recipient is defined in several operation types without specified *Custom message*, duplicate notifications are not sent.

Operation type: **send message**

Parameter	Description
<i>Send to user groups</i>	Select user groups to send the recovery message to. The user group must have at least "read" permissions to the host in order to be notified.
<i>Send to users</i>	Select users to send the recovery message to. The user must have at least "read" permissions to the host in order to be notified.
<i>Send to media type</i>	Send default recovery message to all available (configured and enabled) media types or a specific one only.
<i>Custom message</i>	If selected, a custom message can be defined.
<i>Subject Message</i>	Subject of the custom message. The subject may contain macros. The custom message. The message may contain macros.

Operation type: **remote command**

Parameter	Description
<i>Target list</i>	Select targets to execute the command on: Current host - command is executed on the host of the trigger that caused the problem event. This option will not work if there are multiple hosts in the trigger. Host - select host(s) to execute the command on. Host group - select host group(s) to execute the command on. Specifying a parent host group implicitly selects all nested host groups. Thus the remote command will also be executed on hosts from nested groups. A command on a host is executed only once, even if the host matches more than once (e.g. from several host groups; individually and from a host group). The target list is meaningless if the command is executed on Zabbix server. Selecting more targets in this case only results in the command being executed on the server more times. Note that for global scripts, the target selection also depends on the <i>Host group</i> setting in global script configuration .

Operation type: notify all involved

Parameter	Description
<i>Custom message</i>	If selected, a custom message can be defined.
<i>Subject Message</i>	Subject of the custom message. The subject may contain macros. The custom message. The message may contain macros.

4 Update operations

Overview

Update operations are available in actions with the following event sources:

- *Triggers* - when problems are **updated** by other users, i.e. commented upon, acknowledged, severity has been changed, closed (manually);
- *Services* - when the severity of a service has changed but the service is still not recovered.

Both messages and remote commands are supported in update operations. While several operations can be added, escalation is not supported - all operations are assigned to a single step and therefore will be performed simultaneously.

Configuring an update operation

To configure an update operation go to the *Operations* tab in action **configuration**.

New action ? ×

Action **Operations 4**

* Default operation step duration

Operations	Steps	Details	Start in	Duration	Action
	1	Send message to user groups: Zabbix administrators via Email	Immediately	Default	Edit Remove
Add					

Recovery operations	Details	Action
	Notify all involved	Edit Remove
Add		

Update operations	Details	Action
	Send message to user groups: Zabbix administrators via SMS	Edit Remove
	Notify all involved	Edit Remove
Add		

Pause operations for suppressed problems

Notify about canceled escalations

* At least one operation must exist.

[Add](#) [Cancel](#)

To configure details of a new update operation, click on [Add](#) in the *Update operations* block. To edit an existing operation, click on [Edit](#) next to the operation. A pop-up window will open where you can edit the operation step details.

Update operation details

Operation details ×

Operation

* At least one user or user group must be selected.

Send to user groups [Select](#)
type here to search

Send to users [Select](#)

Send to media type

Custom message

[Add](#) [Cancel](#)

Update operations offer the same set of parameters as **Recovery operations**.

5 Escalations

Overview

With escalations you can create custom scenarios for sending notifications or executing remote commands.

In practical terms it means that:

- Users can be informed about new problems immediately.
- Notifications can be repeated until the problem is resolved.
- Sending a notification can be delayed.
- Notifications can be escalated to another "higher" user group.
- Remote commands can be executed immediately or when a problem is not resolved for a lengthy period.

Actions are escalated based on the **escalation step**. Each step has a duration in time.

You can define both the default duration and a custom duration of an individual step. The minimum duration of one escalation step is 60 seconds.

You can start actions, such as sending notifications or executing commands, from any step. Step one is for immediate actions. If you want to delay an action, you can assign it to a later step. For each step, several actions can be defined.

The number of escalation steps is not limited.

Escalations are defined when **configuring an operation**. Escalations are supported for problem operations only, not recovery.

Miscellaneous aspects of escalation behavior

Let's consider what happens in different circumstances if an action contains several escalation steps.

Situation	Behavior
<i>The host in question goes into maintenance after the initial problem notification is sent</i>	Depending on the <i>Pause operations for suppressed problems</i> setting in action configuration , all remaining escalation steps are executed either with a delay caused by the maintenance period or without delay. A maintenance period does not cancel operations.
<i>The time period defined in the Time period action condition ends after the initial notification is sent</i>	All remaining escalation steps are executed. The <i>Time period</i> condition cannot stop operations; it has effect with regard to when actions are started/not started, not operations.
<i>A problem starts during maintenance and continues (is not resolved) after maintenance ends</i>	Depending on the <i>Pause operations for suppressed problems</i> setting in action configuration , all escalation steps are executed either from the moment maintenance ends or immediately.
<i>A problem starts during a no-data maintenance and continues (is not resolved) after maintenance ends</i>	It must wait for the trigger to fire, before all escalation steps are executed.
<i>Different escalations follow in close succession and overlap</i>	The execution of each new escalation supersedes the previous escalation, but for at least one escalation step that is always executed on the previous escalation. This behavior is relevant in actions upon events that are created with EVERY problem evaluation of the trigger.
<i>During an escalation in progress (like a message being sent), based on any type of event: - the action is disabled - Based on trigger event: - the trigger is disabled - the host or item is disabled - Based on internal event about triggers: - the trigger is disabled - Based on internal event about items/low-level discovery rules: - the item is disabled - the host is disabled</i>	The message in progress is sent and then one more message on the escalation is sent. The follow-up message will have the cancellation text at the beginning of the message body (<i>NOTE: Escalation canceled</i>) naming the reason (for example, <i>NOTE: Escalation canceled: action '<Action name>' disabled</i>). This way the recipient is informed that the escalation is canceled and no more steps will be executed. This message is sent to all who received the notifications before. The reason of cancellation is also logged to the server log file (starting from Debug Level 3=Warning).
<i>During an escalation in progress (like a message being sent) the action is deleted</i>	Note that the <i>Escalation canceled</i> message is also sent if operations are finished, but recovery operations are configured and are not executed yet. No more messages are sent. The information is logged to the server log file (starting from Debug Level 3=Warning), for example: <code>escalation canceled: action id:334 deleted</code>

Escalation examples

Example 1

Sending a repeated notification once every 30 minutes (5 times in total) to a "MySQL Administrators" group. To configure:

- In *Operations* tab, set the *Default operation step duration* to "30m" (30 minutes).
- Set the escalation *Steps* to be from "1" to "5".
- Select the "MySQL Administrators" group as the recipients of the message.

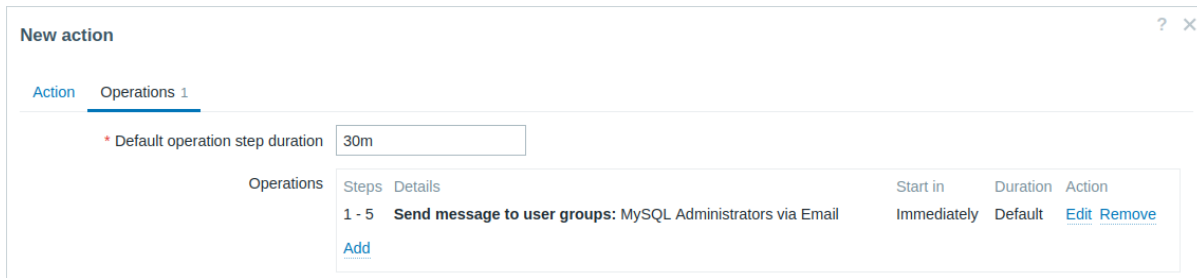

Notifications will be sent at 0:00, 0:30, 1:00, 1:30, 2:00 hours after the problem starts (unless, of course, the problem is resolved sooner).

If the problem is resolved and a recovery message is configured, it will be sent to those who received at least one problem message within this escalation scenario.

Note:
If the trigger that generated an active escalation is disabled, Zabbix sends an informative message about it to all those that have already received notifications.

Example 2

Sending a delayed notification about a long-standing problem. To configure:

- In *Operations* tab, set the *Default operation step duration* to "10h" (10 hours).
- Set the escalation *Steps* to be from "2" to "2".

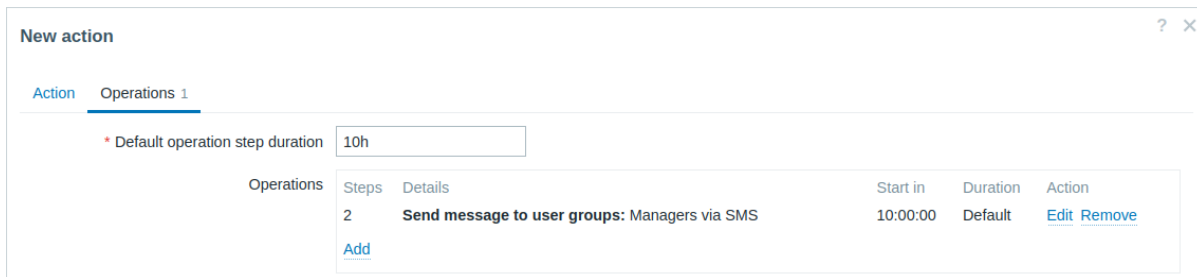

A notification will only be sent at Step 2 of the escalation scenario, or 10 hours after the problem starts.

You can customize the message text to something like "The problem is more than 10 hours old".

Example 3

Escalating the problem to the Boss.

In the first example above we configured periodical sending of messages to MySQL administrators. In this case, the administrators will get four messages before the problem will be escalated to the Database manager. Note that the manager will get a message only in case the problem is not acknowledged yet, supposedly no one is working on it.

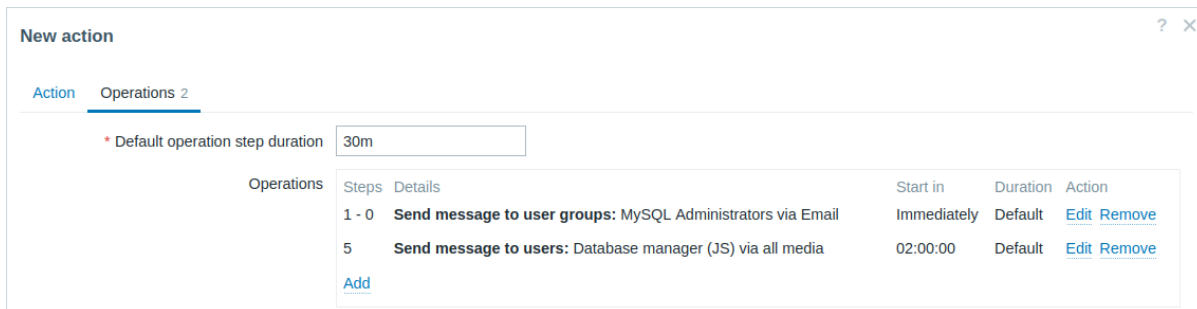

Details of Operation 2:

Operation details ✕

Operation **Send message**

Steps - (0 - infinitely)

Step duration (0 - use action default)

*** At least one user or user group must be selected.**

Send to user groups

Send to users

Send to media type

Custom message

Subject

Message

Problem started at {EVENT.TIME} on {EVENT.DATE}
 Problem name: {EVENT.NAME}
 Host: {HOST.NAME}
 Severity: {EVENT.SEVERITY}

 Original problem ID: {EVENT.ID}
 {TRIGGER.URL}
 {ESC.HISTORY}

Conditions	Label	Name	Action
	A	Event is not acknowledged	Remove
	Add		

Note the use of {ESC.HISTORY} macro in the customized message. The macro will contain information about all previously executed steps on this escalation, such as notifications sent and commands executed.

Example 4

A more complex scenario. After multiple messages to MySQL administrators and escalation to the manager, Zabbix will try to restart the MySQL database. It will happen if the problem exists for 2:30 hours and it hasn't been acknowledged.

If the problem still exists, after another 30 minutes Zabbix will send a message to all guest users.

If this does not help, after another hour Zabbix will reboot server with the MySQL database (second remote command) using IPMI commands.

New action ? X

Action Operations 5

* Default operation step duration

Operations	Steps	Details	Start in	Duration	Action
1 - 0		Send message to user groups: MySQL Administrators via Email	Immediately	Default	Edit Remove
5		Send message to users: Database manager (JS) via all media	02:00:00	Default	Edit Remove
6		Run script "Restart MySQL" on current host	02:30:00	Default	Edit Remove
7		Send message to user groups: Guests via all media	03:00:00	Default	Edit Remove
9		Run script "Restart server" on current host	04:00:00	Default	Edit Remove

[Add](#)

Example 5

An escalation with several operations assigned to one step and custom intervals used. The default operation step duration is 30 minutes.

New action ? X

Action Operations 4

* Default operation step duration

Operations	Steps	Details	Start in	Duration	Action
1 - 4		Send message to user groups: MySQL Administrators via Email	Immediately	Default	Edit Remove
5 - 6		Send message to users: Database manager (JS) via all media	02:00:00	1h	Edit Remove
5 - 7		Send message to user groups: Zabbix administrators via Email	02:00:00	10m	Edit Remove
11		Send message to user groups: Guests via Email	04:00:00	Default	Edit Remove

[Add](#)

Notifications will be sent as follows:

- To MySQL administrators at 0:00, 0:30, 1:00, 1:30 after the problem starts.
- To Database manager at 2:00 and 2:10. (and not at 3:00; seeing that steps 5 and 6 overlap with the next operation, the shorter custom step duration of 10 minutes in the next operation overrides the longer step duration of 1 hour tried to set here).
- To Zabbix administrators at 2:00, 2:10, 2:20 after the problem starts (the custom step duration of 10 minutes working).
- To guest users at 4:00 hours after the problem start (the default step duration of 30 minutes returning between steps 8 and 11).

3 Receiving notification on unsupported items

Overview

It is possible to receive notifications on unsupported items in Zabbix.

It is part of the concept of internal events in Zabbix, allowing users to be notified on these occasions. **Internal events** reflect a change of state:

- when items go from 'normal' to 'unsupported' (and back);
- when triggers go from 'normal' to 'unknown' (and back);
- when low-level discovery rules go from 'normal' to 'unsupported' (and back).

This section presents a how-to for **receiving notification** when an item turns unsupported.

Configuration

Overall, the process of setting up the notification should feel familiar to those who have set up alerts in Zabbix before.

Step 1

Configure **some media**, such as email, SMS, or script to use for the notifications. Refer to the corresponding sections of the manual to perform this task.

Attention:

For notifying on internal events the default severity ('Not classified') is used, so leave it checked when configuring **user media** if you want to receive notifications for internal events.

Step 2

Go to Alerts → Actions → Internal actions.

Click on *Create action* at the top right corner of the page to open an action configuration form.

Step 3

In the *Action* tab enter a name for the action. Then click on *Add* in the *Conditions* block to add a new condition.

The screenshot shows the 'New action' configuration form with the 'Conditions' tab selected. The 'Name' field contains 'Report not supported items'. Below it is a table for conditions with columns 'Label', 'Name', and 'Action'. An 'Add' button is highlighted in the 'Label' column. There is also an 'Enabled' checkbox which is checked. At the bottom right are 'Add' and 'Cancel' buttons. A note at the bottom states: '* At least one operation must exist.'

In the *New condition* pop-up window select "Event type" as the condition type and then select "Item in 'not supported' state" as the event type.

The screenshot shows the 'New condition' pop-up window. The 'Type' dropdown is set to 'Event type'. The 'Operator' is set to 'equals'. The 'Event type' dropdown is set to 'Item in "not supported" state'. At the bottom right are 'Add' and 'Cancel' buttons.

Don't forget to click on *Add* to actually list the condition in the *Conditions* block.

Step 4

In the *Operations* tab, click on *Add* in the *Operations* block to add a new operation.

The screenshot shows the 'New action' configuration form with the 'Operations' tab selected. The 'Default operation step duration' is set to '1h'. Below it are two tables for operations. The first table has columns 'Steps', 'Details', 'Start in', 'Duration', and 'Action'. An 'Add' button is highlighted in the 'Steps' column. The second table has columns 'Details' and 'Action', with an 'Add' button in the 'Details' column. At the bottom right are 'Add' and 'Cancel' buttons. A note at the bottom states: '* At least one operation must exist.'

Select some recipients of the message (user groups/users) and the media type (or "All") to use for delivery. Check the *Custom message* checkbox if you wish to enter the custom subject/content of the problem message.

Operation details ✕

Operation **Send message**

Steps - (0 - infinitely)

Step duration (0 - use action default)

*** At least one user or user group must be selected.**

Send to user groups
type here to search

Send to users

Send to media type ▾

Custom message

Subject

Message

Host: {HOST.NAME}
 Item: {ITEM.NAME}
 Key: {ITEM.KEY}
 State: {ITEM.STATE}

Click on *Add* to actually list the operation in the *Operations* block.

If you wish to receive more than one notification, set the operation step duration (interval between messages sent) and add another step.

Step 5

The *Recovery operations* block allows to configure a recovery notification when an item goes back to the normal state. Click on *Add* in the *Recovery operations* block to add a new recovery operation.

New action ? ✕

Action Operations 1

*** Default operation step duration**

Operations	Steps	Details	Start in	Duration	Action
	1	Send message to user groups: Zabbix administrators via Email	Immediately	Default	Edit Remove
Add					

Recovery operations	Action
Add	

*** At least one operation must exist.**

Select the operation type "Notify all involved". Select *Custom message* checkbox if you wish to enter the custom subject/content of the problem message.

Operation details ✕

Operation

Custom message

Subject

Message

Click on *Add* in the *Operation details* pop-up window to actually list the operation in the *Recovery operations* block.

Step 6

When finished, click on the *Add* button at the bottom of the form.

New action ? ✕

Action Operations 2

* Default operation step duration

Operations	Steps	Details	Start in	Duration	Action
	1	Send message to user groups: Zabbix administrators via Email	Immediately	Default	Edit Remove
	Add				
Recovery operations	Details		Action		
	Notify all involved		Edit Remove		
	Add				

* At least one operation must exist.

And that's it, you're done! Now you can look forward to receiving your first notification from Zabbix if some item turns unsupported.

11 Macros

Overview

Zabbix supports a number of built-in macros which may be used in various situations. These macros are variables, identified by a specific syntax:

{MACRO}

Macros resolve to a specific value depending on the context.

Effective use of macros allows to save time and make Zabbix configuration more transparent.

In one of typical uses, a macro may be used in a template. Thus a trigger on a template may be named "Processor load is too high on {HOST.NAME}". When the template is applied to the host, such as Zabbix server, the name will resolve to "Processor load is too high on Zabbix server" when the trigger is displayed in the Monitoring section.

Macros may be used in item key parameters. A macro may be used for only a part of the parameter, for example `item.key[server_{HOST.HOST}_local]`. Double-quoting the parameter is not necessary as Zabbix will take care of any ambiguous special symbols, if present in the resolved macro.

There are other types of macros in Zabbix.

Zabbix supports the following macros:

- `{MACRO}` - built-in macro (see [full list](#))
- `{<macro>.<func>(<params>)}` - macro [functions](#)
- `{$MACRO}` - [user-defined macro](#), optionally [with context](#)
- `{#MACRO}` - macro for [low-level discovery](#)
- `{?EXPRESSION}` - [expression macro](#)

1 Macro functions

Macro functions offer the ability to customize [macro](#) values (for example, shorten or extract specific substrings), making them easier to work with.

All functions listed here are supported with all types of macros:

- [Built-in macros](#)
- [User macros](#)
- [Low-level discovery macros](#)
- [Expression macros](#)

Macro functions can be used in all locations supporting the listed macros. This applies unless explicitly stated that only a macro is expected (for example, when configuring [host macros](#) or low-level discovery rule [filters](#)).

The functions are listed without additional information. Click on the function to see the full details.

Function	Description
btoa	Encoding macro value into Base64 encoding.
fmtnum	Number formatting to control the number of digits printed after the decimal point.
fmttime	Time formatting.
htmldecode	Decoding macro value from HTML encoding.
htmlencode	Encoding macro value into HTML encoding.
iregsub	Substring extraction by a regular expression match (case-insensitive).
lowercase	Transformation of macro value characters into lowercase.
regrepl	Replacement of character/substring in macro value.
regsub	Substring extraction by a regular expression match (case-sensitive).
tr	Transliteration of macro value characters.
uppercase	Transformation of macro value characters into uppercase.
urldecode	Decoding macro value from URL encoding.
urlencode	Encoding macro value into URL encoding.

Function details

The syntax of a macro function is:

`{macro.func(params)}`

- **macro** - the macro to customize, for example `{ITEM.VALUE}` or `{#LLDMACRO}`;
- **func** - the function to apply;
- **params** - a comma-delimited list of function parameters, which must be quoted if:
 - start with a space or double quotes;
 - contain closing parentheses `""` or a comma.

Optional function parameters are indicated by `< >`.

btoa

Encoding a macro value into Base64 encoding. Base64 encoding is a method for representing binary data as text, useful for storing and secure transmission of binary content over text-based protocols.

Example:

`{{ITEM.VALUE}.btoa()}` - Base64-encode a value like "zabbix" into "emFiYm14"

fmtnum(digits)

Number formatting to control the number of digits printed after the decimal point.

Parameters:

- **digits** - the number of digits after decimal point. Valid range: 0-20. No trailing zeros will be produced.

Examples:

Macro function	Received value	Output
<code>{{ITEM.VALUE}.fmtnum(2)}</code>	24.3413523	24.34
<code>{{ITEM.VALUE}.fmtnum(0)}</code>	24.3413523	24

`fmttime(format,<time_shift>)`

Time formatting.
 Note that this function can be used with macros that resolve to a value in one of the following time formats:

- `hh:mm:ss`
- `yyyy-mm-ddThh:mm:ss [tz]` (ISO8601 standard)
- unix timestamp

Parameters:

- **format** - mandatory format string, compatible with `strftime` function formatting;

- **time_shift** (optional) - the time shift applied to the time before formatting; should start with `-<N><time_unit>` or `+<N><time_unit>`, where:

 - `N` - the number of time units to add or subtract;
 - `time_unit` - h (hour), d (day), w (week), M (month) or y (year).

Comments:

- The `time_shift` parameter supports multistep time operations and may include `/<time_unit>` for shifting to the beginning of the time unit (`/d` - midnight, `/w` - 1st day of the week (Monday), `/M` - 1st day of the month, etc.). Examples: `-1w` - exactly 7 days back; `-1w/w` - Monday of the previous week; `-1w/w+1d` - Tuesday of the previous week.
- Time operations are calculated from left to right without priorities. For example, `-1M/d+1h/w` will be parsed as `((-1M/d)+1h)/w`.

Examples:

Macro function	Received value	Output
<code>{{TIME}.fmttime(%B)}</code>	12:36:01	October
<code>{{TIME}.fmttime(%d %B,-1M/M)}</code>	12:36:01	1 September

`htmldecode`

Decoding a macro value from HTML encoding.

The following characters are supported:

Value	Decoded value
<code>&amp;</code>	<code>&</code>
<code>&lt;</code>	<code><</code>
<code>&gt;</code>	<code>></code>
<code>&quot;</code>	<code>"</code>
<code>&#039;</code>	<code>'</code>
<code>&#39;</code>	<code>'</code>

Example:

`{{ITEM.VALUE}.htmldecode()}` - HTML-decode a value like `"<"` into `"<"`

`htmlencode`

Encoding a macro value into HTML encoding.

The following characters are supported:

Value	Encoded value
<code>&</code>	<code>&amp;</code>
<code><</code>	<code>&lt;</code>
<code>></code>	<code>&gt;</code>

Value	Encoded value
"	"
'	'

Example:

`{{ITEM.VALUE}.htmlencode()}` - HTML-encode a character like "<" into "<";

`iregsub(pattern,output)`

Substring extraction by a regular expression match (case-insensitive).

Parameters:

- **pattern** - the regular expression to match;
- **output** - the output options. `\1` - `\9` placeholders are supported to capture groups. `\0` returns the matched text.

Comments:

- If the function pattern is an incorrect regular expression, then the macro evaluates to 'UNKNOWN' (except for low-level discovery macros, in which case the function will be ignored, and the macro will remain unresolved).

lowercase

Transformation of all macro value characters into lowercase. Works with single-byte character sets (such as ASCII) and does not support UTF-8.

Example:

`{{ITEM.VALUE}.lowercase()}` - transform a value like "Zabbix SERVER" into "zabbix server" (lowercase)

`regrepl(pattern,replacement,<pattern2>,<replacement2>,...)`

Replacement of character/substring in macro value. *Note* that this function is only supported with the **libpcre2** library. If Zabbix server/proxy was compiled with **libpcre**, this function will return UNKNOWN.

Parameters:

- **pattern** - the regular expression to match;
- **replacement** - the replacement string.

Comments:

- The patterns and replacements are processed sequentially, with each subsequent pair being applied in accordance with the outcome of the previous replacement;
- This function also allows referencing captured groups in replacement strings using `\1` to `\9` placeholders.

Examples:

`{{ITEM.VALUE}.regrepl("oldParam", "newParam")}` - replace "oldParam" with "newParam"

`{{ITEM.VALUE}.regrepl("[^a-z]", "\\1")}` - escape all non-letter characters with a backslash

`{{ITEM.VALUE}.regrepl("_v1\\.0", "_v2.0", "\\(final\\)", "")}` - replace multiple parts in item value

`regsub(pattern,output)`

Substring extraction by a regular expression match (case-sensitive).

Parameters:

- **pattern** - the regular expression to match;
- **output** - the output options. `\1` - `\9` placeholders are supported to capture groups. `\0` returns the matched text.

Comments:

- If the function pattern is an incorrect regular expression, then the macro evaluates to 'UNKNOWN' (except for low-level discovery macros, in which case the function will be ignored, and the macro will remain unresolved).

Examples:

Macro function	Received value	Output
<code>{{ITEM.VALUE}.regsub(^[0-9]+, Problem)}</code>	123Log line	Problem
<code>{{ITEM.VALUE}.regsub("^[0-9]+", "Problem")}</code>	123 Log line	Problem

Macro function	Received value	Output
<code>{{ITEM.VALUE}.regsub("^[0-9]+", "Problem ID: \1)}</code>	123 Log line	Problem ID: 123
<code>{{ITEM.VALUE}.regsub(".*", "Problem ID: \1")}</code>	Log line	"Problem ID: "
<code>{{ITEM.VALUE}.regsub("^(\\w+).*?([0-9]+)", "Problem ID: \1_2 ")}</code>	MySQL crashed errno 123	" Problem ID: MySQL_123 "
<code>{{ITEM.VALUE}.regsub("([1-9]+", "Problem ID: \1")}</code>	123 Log line	*UNKNOWN* (invalid regular expression)
<code>{{#IFALIAS}.regsub("(.*)_([0-9]+)", \1)}</code>	customername_1	customername
<code>{{#IFALIAS}.regsub("(.*)_([0-9]+)", \2)}</code>	customername_11	
<code>{{#IFALIAS}.regsub("(.*)_([0-9]+", \1)}</code>	customername_1	<code>{{#IFALIAS}.regsub("(.*)_([0-9]+", \1)}</code> (invalid regular expression)
<code>`\${MACRO}`:{{#IFALIAS}.regsub("\\(.*)_([0-9]+)", \1)}</code>	customername_1	<code>`\${MACRO}`:customername`</code>
<code>`\${MACRO}`:{{#IFALIAS}.regsub("\\(.*)_([0-9]+)", \2)}</code>	customername_1	<code>`\${MACRO}`:1`</code>
<code>`\${MACRO}`:{{#IFALIAS}.regsub("\\(.*)_([0-9]+)", \1)}</code>	customername_1	<code>`\${MACRO}`:{{#M}.regsub("\\(.*)_([0-9]+", \1)}</code> (invalid regular expression)
<code>`\${MACRO}`:{{#IFALIAS}.regsub("\\(.*)_([0-9]+)", \1)}</code>	customername_1	<code>`\${MACRO}`:customername`</code>
<code>`\${MACRO}`:{{#IFALIAS}.regsub("\\(.*)_([0-9]+)", \2)}</code>	customername_1	<code>`\${MACRO}`:1`</code>
<code>`\${MACRO}`:{{#IFALIAS}.regsub("\\(.*)_([0-9]+)", \1)}</code>	customername_1	<code>`\${MACRO}`:{{#IFALIAS}.regsub("\\(.*)_([0-9]+", \1)}</code> (invalid regular expression)

`tr(characters,replacement)`

Transliteration of macro value characters.

- **characters** - the set of characters to replace;
- **replacement** - the set of positionally corresponding replacement characters.

Examples:

```

{{ITEM.VALUE}.tr(abc, xyz)} - replace all occurrences of "a" with "x", "b" with "y", "c" with "z"
{{ITEM.VALUE}.tr(abc, xyzq)} - replace all occurrences of "a" with "x", "b" with "y", "c" with "z" ("q" is
{{ITEM.VALUE}.tr(abcde, xyz)} - replace all occurrences of "a" with "x", "b" with "y", "c" with "z", "d" w
{{ITEM.VALUE}.tr("\\\\", "/")} - replace all occurrences of backslash with forward slash, ' with "
{{ITEM.VALUE}.tr(A-Z,a-z)} - convert all letters to lowercase
{{ITEM.VALUE}.tr(0-9a-z,*)} - replace all numbers and lowercase letters with "*"
{{ITEM.VALUE}.tr(0-9,ab)} - replace all occurrences of 0 with "a", and replace all occurrences of 1, 2, 3,
{{ITEM.VALUE}.tr(0-9abcA-L,*)} - replace all numbers, "abc" characters, and A-L range with "*"
{{ITEM.VALUE}.tr("\n","*")} - replace end-of-line occurrences with *
{{ITEM.VALUE}.tr("e", "\n")} - replace all "e" to end-of-line

```

To include literal characters:

```

backslash - must be escaped as \\
single quote - must be escaped as \'
double quote - must be escaped as \"

```

Supported escape sequences with backslash:

```

\\\\ => \\ - double backslash to single backslash
\\a  => \a - alert
\\b  => \b - backspace
\\f  => \f - form feed
\\n  => \n - newline
\\r  => \r - return
\\t  => \t - horizontal tab
\\v  => \v - vertical tab

```

uppercase

Transformation of all macro value characters into uppercase. Works with single-byte character sets (such as ASCII) and does not support UTF-8.

Example:

```
{{ITEM.VALUE}.uppercase()}
```

 - transform a value like "Zabbix Server" into "ZABBIX SERVER" (uppercase)

urldecode

Decoding a macro value from URL encoding.

Example:

```
{{ITEM.VALUE}.urldecode()}
```

 - URL-decode a value like "%2F" into "/"

urlencode

Encoding a macro value into URL encoding.

Example:

```
{{ITEM.VALUE}.urlencode()}
```

 - URL-encode a character like "/" into "%2F"

2 User macros

Overview

User macros are supported in Zabbix for greater flexibility, in addition to the macros **supported** out-of-the-box.

User macros can be defined on global, template and host level. These macros have a special syntax:

```
{${MACRO}}
```

Zabbix resolves macros according to the following precedence:

1. host level macros (checked first)
2. macros defined for first level templates of the host (i.e., templates linked directly to the host), sorted by template ID
3. macros defined for second level templates of the host, sorted by template ID
4. macros defined for third level templates of the host, sorted by template ID, etc.
5. global macros (checked last)

In other words, if a macro does not exist for a host, Zabbix will try to find it in the host templates of increasing depth. If still not found, a global macro will be used, if exists.

Warning:

If a macro with the **same name** exists on multiple linked templates of the same level, the macro from the template with the lowest ID will be used. Thus having macros with the same name in multiple templates is a configuration risk.

If Zabbix is unable to find a macro, the macro will not be resolved.

Attention:

Macros (including user macros) are left unresolved in the Configuration section (for example, in the trigger list) by design to make complex configuration more transparent.

User macros can be used in:

- item name
- item key parameter
- item update intervals and flexible intervals
- trigger name and description
- trigger expression parameters and constants (see **examples**)
- many other locations - see the **full list**

Common use cases of global and host macros

- use a global macro in several locations; then change the macro value and apply configuration changes to all locations with one click
- take advantage of templates with host-specific attributes: passwords, port numbers, file names, regular expressions, etc.

Note:

It is advisable to use host macros instead of global macros because adding, updating or deleting global macros forces incremental configuration update for all hosts. For more information, see [Passive and active agent checks](#).

Configuration

To define user macros, go to the corresponding location in the frontend:

- for global macros, visit *Administration* → *Macros*
- for host and template level macros, open host or template properties and look for the *Macros* tab

Note:

If a user macro is used in items or triggers in a template, it is suggested to add that macro to the template even if it is defined on a global level. That way, if the macro type is *text* exporting the template to XML and importing it in another system will still allow it to work as expected. Values of secret macros are not **exported**.

A user macro has the following attributes:

Macro	Value		Description
{MYSQL_PASSWORD}	*****		description
{MYSQL_USERNAME}	*****		description
{SECRET_PASSWORD}	path/to/secret:password		description
{SECRET_USERNAME}	path/to/secret:username		description
{SNMP_COMMUNITY}	public		description
{WORKING_HOURS}	1-5,09:00-18:00		description

[Add](#)

Parameter	Description
<i>Macro</i>	Macro name. The name must be wrapped in curly brackets and start with a dollar sign. Example: {\$FRONTEND_URL}. The following characters are allowed in the macro names: A-Z (uppercase only) , 0-9 , _ , .
<i>Value</i>	Macro value. Three value types are supported: Text (default) - plain-text value Secret text - the value is masked with asterisks Vault secret - the value contains a path/query to a vault secret .
<i>Description</i>	Text field used to provide more information about this macro.

Attention:

In trigger expressions user macros will resolve if referencing a parameter or constant. They will NOT resolve if referencing a host, item key, function, operator or another trigger expression. Secret macros cannot be used in trigger expressions.

Examples

Example 1

Use of host-level macro in the "Status of SSH daemon" item key:

```
net.tcp.service[ssh, , {$SSH_PORT}]
```

This item can be assigned to multiple hosts, providing that the value of **{SSH_PORT}** is defined on those hosts.

Example 2

Use of host-level macro in the "CPU load is too high" trigger:

```
last(/ca_001/system.cpu.load[,avg1])>{$MAX_CPULOAD}
```

Such a trigger would be created on the template, not edited in individual hosts.

Note:

If you want to use the amount of values as the function parameter (for example, **max(/host/key,#3)**), include hash mark in the macro definition like this: **SOME_PERIOD => #3**

Example 3

Use of two macros in the "CPU load is too high" trigger:

```
min(/ca_001/system.cpu.load[,avg1],{$CPULOAD_PERIOD})>{$MAX_CPULOAD}
```

Note that a macro can be used as a parameter of trigger function, in this example function **min()**.

Example 4

Synchronize the agent unavailability condition with the item update interval:

- define {\$INTERVAL} macro and use it in the item update interval;
- use {\$INTERVAL} as parameter of the agent unavailability trigger:

```
nodata(/ca_001/agent.ping,{$INTERVAL})=1
```

Example 5

Centralize configuration of working hours:

- create a global {\$WORKING_HOURS} macro equal to 1-5,09:00-18:00;
- use it in the *Working time* field in *Administration* → *General* → *GUI*;
- use it in the *When active* field in *Users* → *Users, Media* tab of a user;
- use it to set up more frequent item polling during working hours:

Update interval

Custom intervals	Type	Interval	Period
	Flexible Scheduling	<input style="border: 1px solid #ccc;" type="text" value="{\$SHORT_INTERVAL}"/>	<input style="border: 1px solid #ccc;" type="text" value="{\$WORKING_HOURS}"/>

- use it in the *Time period* action condition;
- adjust the working time in *Administration* → *Macros*, if needed.

Example 6

Use host prototype macro to configure items for discovered hosts:

- on a host prototype define user macro {\$SNMPVALUE} with {#SNMPVALUE} **low-level discovery** macro as a value:

Host prototype macros
Inherited and host prototype macros

Macro	Value
<input style="width: 95%;" type="text" value="{\$SNMPVALUE}"/>	<input style="width: 95%;" type="text" value="{#SNMPVALUE}"/> T ▾

Add

Add

Cancel

- assign *Generic SNMPv2* template to the host prototype;
- use {\$SNMPVALUE} in the *SNMP OID* field of *Generic SNMPv2* template items.

User macro context

See [user macros with context](#).

3 User macros with context

Overview

An optional context can be used in **user macros**, allowing to override the default value with a context-specific one.

The context is appended to the macro name; the syntax depends on whether the context is a static text value:

```
{${MACRO:"static text"}}
```

or a regular expression:

```
{${MACRO:regex:"regular expression"}}
```

Note that a macro with regular expression context can only be defined in user macro configuration. If the `regex:` prefix is used elsewhere as user macro context, like in a trigger expression, it will be treated as static context.

Context quoting is optional (see also **important notes**).

Macro context examples:

Example	Description
<code>{\${LOW_SPACE_LIMIT}}</code>	User macro without context.
<code>{\${LOW_SPACE_LIMIT:/tmp}}</code>	User macro with context (static string).
<code>{\${LOW_SPACE_LIMIT:regex:"~/tmp\$"}}</code>	User macro with context (regular expression). Same as <code>{\${LOW_SPACE_LIMIT:/tmp}</code> .
<code>{\${LOW_SPACE_LIMIT:regex:"~/var/log/.*\$"}}</code>	User macro with context (regular expression). Matches all strings prefixed with <code>/var/log/</code> .

Use cases

User macros with context can be defined to accomplish more flexible thresholds in trigger expressions (based on the values retrieved by low-level discovery). For example, you may define the following macros:

- `{${LOW_SPACE_LIMIT} = 10`
- `{${LOW_SPACE_LIMIT:/home} = 20`
- `{${LOW_SPACE_LIMIT:regex:"^[a-z]+$" = 30`

Then a low-level discovery macro may be used as macro context in a trigger prototype for mounted file system discovery:

```
last(/host/vfs.fs.size[{-#FSNAME},pfree])<{${LOW_SPACE_LIMIT:"{-#FSNAME}"}
```

After the discovery different low-space thresholds will apply in triggers depending on the discovered mount points or file system types. Problem events will be generated if:

- `/home` folder has less than 20% of free disk space
- folders that match the regexp pattern (like `/etc`, `/tmp` or `/var`) have less than 30% of free disk space
- folders that don't match the regexp pattern and are not `/home` have less than 10% of free disk space

Important notes

- If more than one user macro with context exists, Zabbix will try to match the simple context macros first and then context macros with regular expressions in an undefined order.

Warning:

Do not create different context macros matching the same string to avoid undefined behavior.

- If a macro with its context is not found on host, linked templates or globally, then the macro without context is searched for.
- Only low-level discovery macros are supported in the context. Any other macros are ignored and treated as plain text.

Technically, macro context is specified using rules similar to **item key** parameters, except macro context is not parsed as several parameters if there is a `,` character:

- Macro context must be quoted with `"` if the context contains a `}` character or starts with a `"` character. Quotes inside quoted context must be escaped with the `\` character.
- The `\` character itself is not escaped, which means it's impossible to have a quoted context ending with the `\` character - the macro `{${MACRO:"a\b\c"}}` is invalid.
- The leading spaces in context are ignored, the trailing spaces are not:
 - For example `{${MACRO:A}` is the same as `{${MACRO: A}`, but not `{${MACRO:A }`.
- All spaces before leading quotes and after trailing quotes are ignored, but all spaces inside quotes are not:

- Macros `{$MACRO:"A"}`, `{$MACRO: "A"}`, `{$MACRO:"A" }` and `{$MACRO: "A" }` are the same, but macros `{$MACRO:"A"}` and `{$MACRO:" A "}` are not.

The following macros are all equivalent, because they have the same context: `{$MACRO:A}`, `{$MACRO: A}` and `{$MACRO:"A"}`. This is in contrast with item keys, where 'key[a]', 'key[a]' and 'key["a"]' are the same semantically, but different for uniqueness purposes.

4 Secret user macros

Zabbix provides two options for protecting sensitive information in user macro values:

- Secret text
- Vault secret

Note that while the value of a secret macro is hidden, the value can be revealed through the use in items. For example, in an external script an 'echo' statement referencing a secret macro may be used to reveal the macro value to the frontend because Zabbix server has access to the real macro value. See also [locations](#) where secret macro values are unmasked.

Secret macros cannot be used in trigger expressions.

Secret text

Values of secret text macros are masked by the asterisks.

To make macro value 'secret', click on the button at the end of the value field and select the option *Secret text*.



Once the configuration is saved, it will no longer be possible to view the value.

The macro value will be displayed as asterisks.

To enter a new value, hover over the value field and press Set new value button (appears on hover).



If you change macro value type or press *Set new value*, current value will be erased. To revert the original value, use the backwards arrow at the right end of the *Value* field (only available before saving new configuration). Reverting the value will not expose it.

Note:

URLs that contain a secret macro will not work as the macro in them will be resolved as "*****".

Vault secret

With Vault secret macros, the actual macro value is stored in an external secret management software (vault).

To configure a Vault secret macro, click on the button at the end of the Value field and select the option *Vault secret*.

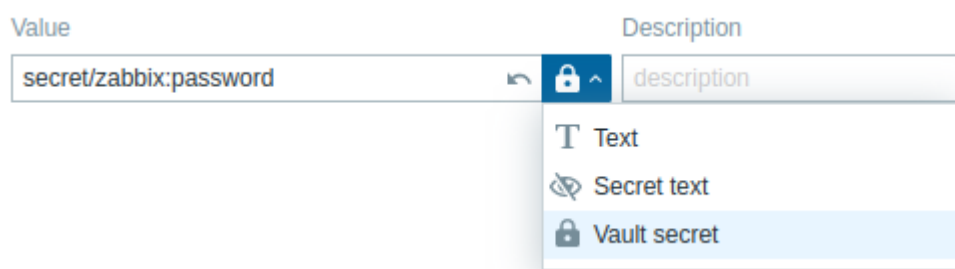

The macro value should point to a vault secret. The input format depends on the vault provider. For provider-specific configuration examples, see:

- HashiCorp
- CyberArk

Vault secret values are retrieved by Zabbix server on every refresh of configuration data and then stored in the configuration cache.

To manually trigger refresh of secret values from a vault, use the 'secrets_reload' command-line **option**.

Zabbix proxy receives values of vault secret macros from Zabbix server on each configuration sync and stores them in its own configuration cache. The proxy never retrieves macro values from the vault directly. That means a Zabbix proxy cannot start data collection after a restart until it receives the configuration data update from Zabbix server for the first time.

Encryption must be enabled between Zabbix server and proxy; otherwise a server warning message is logged.

Warning:

If a macro value cannot be retrieved successfully, the corresponding item using the value will turn unsupported.

Unmasked locations

This list provides locations of parameters where secret macro values are unmasked.

Context	Parameter
Items	
Item	<i>Item key parameters</i>
SNMP agent	<i>SNMP community</i> <i>Context name (SNMPv3)</i> <i>Security name (SNMPv3)</i> <i>Authentication passphrase (SNMPv3)</i> <i>Privacy passphrase (SNMPv3)</i>
HTTP agent	<i>URL</i> <i>Query fields</i> <i>Post</i> <i>Headers</i> <i>Username</i> <i>Password</i> <i>SSL key password</i>
Script	<i>Parameters</i> <i>Script</i>
Browser	<i>Parameters</i> <i>Script</i>
Database monitor	<i>SQL query</i>
Telnet	<i>Script</i> <i>Username, password</i>
SSH	<i>Script</i> <i>Username, password</i>
Simple check	<i>Username, password</i>
JMX	<i>Username, password</i>
Item value preprocessing	
JavaScript preprocessing step	<i>Script</i>
Web scenarios	
Web scenario	<i>Variable value</i> <i>Header value</i> <i>URL</i> <i>Query field value</i> <i>Post field value</i> <i>Raw post</i>
Web scenario authentication	<i>User</i> <i>Password</i> <i>SSL key password</i>
Connectors	
Connector	<i>URL</i> <i>Username</i> <i>Password</i> <i>Token</i> <i>HTTP proxy</i>

Context		Parameter
		SSL certificate file
		SSL key file
		SSL key password
Network discovery		
	SNMP	SNMP community
		Context name (SNMPv3)
		Security name (SNMPv3)
		Authentication passphrase (SNMPv3)
		Privacy passphrase (SNMPv3)
Global scripts		
	Webhook	JavaScript script
		JavaScript script parameter value
	Telnet	Username, password
	SSH	Username, password
	Script	Script
Media types		
	Script	Script parameters
	Webhook	Parameters
IPMI		Username
		Password

5 Low-level discovery macros

Overview

There is a type of macro used within the **low-level discovery** (LLD) function:

{#MACRO}

It is a macro that is used in an LLD rule and returns real values of the file system name, network interface, SNMP OID, etc.

These macros can be used for creating item, trigger and graph *prototypes*. Then, when discovering real file systems, network interfaces etc., these macros are substituted with real values and are the basis for creating real items, triggers and graphs.

These macros are also used in creating host and host group *prototypes* in virtual machine **discovery**.

Some low-level discovery macros come "pre-packaged" with the LLD function in Zabbix - {#FSNAME}, {#FSTYPE}, {#IFNAME}, {#SNMPINDEX}, {#SNMPVALUE}. However, adhering to these names is not compulsory when creating a **custom** low-level discovery rule. Then you may use any other LLD macro name and refer to that name.

Supported locations

LLD macros can be used:

- in the low-level discovery rule filter
- for item prototypes in
 - name
 - key parameters
 - unit
 - update interval¹
 - timeout¹
 - history storage period¹
 - trend storage period¹
 - item value preprocessing steps
 - SNMP OID
 - IPMI sensor field
 - calculated/aggregate item expression, in:
 - * expression constants and function parameters
 - * item key parameters
 - aggregate item filter conditions (host group name and tag name)
 - SSH script and Telnet script

- database monitoring SQL query
- JMX item endpoint field
- description
- HTTP agent URL field
- HTTP agent HTTP query fields field
- HTTP agent request body field
- HTTP agent required status codes field
- HTTP agent headers field key and value
- HTTP agent HTTP authentication username field
- HTTP agent HTTP authentication password field
- HTTP agent HTTP proxy field
- HTTP agent HTTP SSL certificate file field
- HTTP agent HTTP SSL key file field
- HTTP agent HTTP SSL key password field
- tags
- for trigger prototypes in
 - name
 - operational data
 - expression (only in constants and function parameters)
 - URL
 - description
 - tags
- for graph prototypes in
 - name
- for host prototypes in
 - name
 - visible name
 - custom interface fields: IP, DNS, port, SNMP v1/v2 community, SNMP v3 context name, SNMP v3 security name, SNMP v3 authentication passphrase, SNMP v3 privacy passphrase
 - host group prototype name
 - host tag value
 - host macro value
 - (see the [full list](#))

In all those places, except the low-level discovery rule filter, LLD macros can be used inside static user **macro context**.

Using macro functions

Macro functions are supported with low-level discovery macros (except in low-level discovery rule **filter**), allowing to extract a certain part of the macro value using a regular expression.

For example, you may want to extract the customer name and interface number from the following LLD macro for the purposes of event tagging:

```
{#IFALIAS}=customername_1
```

To do so, the `regsub` macro function can be used with the macro in the event tag value field of a trigger prototype:

The screenshot shows the 'Trigger prototype' configuration page in Zabbix, specifically the 'Tags' tab. There are two sub-tabs: 'Trigger tags' (selected) and 'Inherited and trigger tags'. Below these is a table with two columns: 'Name' and 'Value'. The table contains two entries:

Name	Value
customer	{#IFALIAS}.regsub("(.*)_([0-9]+)", \1)}
interface	{#IFALIAS}.regsub("(.*)_([0-9]+)", \2)}

Note that commas are not allowed in unquoted item **key parameters**, so the parameter containing a macro function has to be quoted. The backslash (\) character should be used to escape double quotes inside the parameter. Example:

```
net.if.in["{#IFALIAS}.regsub(\"(.*)_([0-9]+)\", \1)"] , bytes]
```

For more information on macro function syntax, see: [Macro functions](#)

Macro functions are supported in low-level discovery macros since Zabbix 4.0.

Footnotes

¹ In the fields marked with ¹ a single macro has to fill the whole field. Multiple macros in a field or macros mixed with text are not supported.

6 Expression macros

Overview

Expression macros are useful for formula calculations. They are calculated by expanding all macros inside and evaluating the resulting expression.

Expression macros have a special syntax:

```
{?EXPRESSION}
```

The syntax in EXPRESSION is the same as in [trigger expressions](#) (see usage limitations below).

{FUNCTION.VALUE<1-9>} and {FUNCTION.RECOVERY.VALUE<1-9>} macros can be used to reference function values of the trigger expressions and trigger recovery expressions, for example:

```
{?{FUNCTION.VALUE2} - {FUNCTION.VALUE3}}
```

{HOST.HOST<1-9>} and {ITEM.KEY<1-9>} macros can be used inside the functions to reference hosts and items, for example:

```
{?max(/{HOST.HOST}/{ITEM.KEY},3h)}
```

Usage

In the following locations:

- graph names
- map element labels
- map shape labels
- map link labels

only a **single** function, from the following set: avg, last, max, min, is allowed as an expression macro, e.g.:

```
{?avg(/{HOST.HOST}/{ITEM.KEY},1h)}
```

Expressions such as {?last(/host/item1)/last(/host/item2)}, {?count(/host/item1,5m)} and {?last(/host/item1)*10} are incorrect in these locations.

However, in:

- trigger event names
- trigger-based notifications and commands
- problem update notifications and commands

complex expressions are allowed, e.g.:

```
{?trendavg(/host/item1,1M:now/M)/trendavg(/host/item1,1M:now/M-1y)*100}
```

Note:

When using expression macros in templates please do not specify the template name but rather use {HOST.HOST<N>}, because template names are not substituted with hosts during linkage. You can also omit host reference altogether for the first host, e.g. {?avg(/item1,1h)}

See also:

- [Supported macros](#) for a list of supported locations of the expression macro
- [Example](#) of using an expression macro in the event name

12 Users and user groups

Overview

All users in Zabbix access the Zabbix application through the web-based frontend. Each user is assigned a unique login name and a password.

All user passwords are encrypted and stored in the Zabbix database. Users cannot use their user id and password to log directly into the UNIX server unless they have also been set up accordingly to UNIX. Communication between the web server and the user browser can be protected using SSL.

With a flexible **user permission schema** you can restrict and differentiate rights to:

- access administrative Zabbix frontend functions
- perform certain actions in the frontend
- access monitored hosts in hostgroups
- use specific API methods

1 Configuring a user

Overview

The initial Zabbix installation has two predefined users:

- *Admin* - a Zabbix **superuser** with full permissions.
- *guest* - a special Zabbix **user**. The 'guest' user is disabled by default. If you add it to the Guests user group, you may log in with this user and access monitoring pages in Zabbix. Note that by default, 'guest' has no permissions on Zabbix objects.

To configure a user:

- Go to *Users* → *Users*.
- Click on *Create user* (or on a user name to edit an existing user).
- Edit user attributes in the form.

General attributes

The *User* tab contains general user attributes:

User **Media 2** Permissions

* Username

Name

Last name

Groups
type here to search

* Password ?

* Password (once again)

Password is not mandatory for non internal authentication type.

Language ▾

Time zone ▾

Theme ▾

Auto-login

Auto-logout

* Refresh

* Rows per page

URL (after login)

All mandatory input fields are marked with a red asterisk.

Parameter	Description
<i>Username</i>	Unique username, used as the login name.
<i>Name</i>	User first name (optional). If not empty, visible in acknowledgment information and notification recipient information.
<i>Last name</i>	User last name (optional). If not empty, visible in acknowledgment information and notification recipient information.
<i>Groups</i>	Select user groups the user belongs to. This field is auto-complete so starting to type the name of a user group will offer a dropdown of matching groups. Scroll down to select. Alternatively, click on <i>Select</i> to add groups. Click on 'x' to remove the selected. Adherence to user groups determines what host groups and hosts the user will have access to .
<i>Password</i>	Two fields for entering the user password, or a <i>Change password</i> button if the user already exists. Clicking on the <i>Change password</i> button opens two fields for entering a new password. For the user with the <i>Super admin role</i> changing own password, clicking on the <i>Change password</i> button opens an additional field for entering the current (old) password. On a successful password change, the user for which the password was changed will be logged out of all active sessions. Note that the password can only be changed for users using Zabbix internal authentication .
<i>Language</i>	Language of the Zabbix frontend. The php gettext extension is required for the translations to work.
<i>Time zone</i>	Select the time zone to override global time zone on user level or select System default to use global time zone settings.
<i>Theme</i>	Defines how the frontend looks like: System default - use default system settings Blue - standard blue theme Dark - alternative dark theme High-contrast light - light theme with high contrast High-contrast dark - dark theme with high contrast
<i>Auto-login</i>	Mark this checkbox to make Zabbix remember the user and log the user in automatically for 30 days. Browser cookies are used for this.
<i>Auto-logout</i>	With this checkbox marked the user will be logged out automatically, after the set amount of seconds (minimum 90 seconds, maximum 1 day). Time suffixes are supported, e.g. 90s, 5m, 2h, 1d. Note that this option will not work: * If the "Show warning if Zabbix server is down" global configuration option is enabled and Zabbix frontend is kept open. * When Monitoring menu pages perform background information refreshes. * If logging in with the <i>Remember me for 30 days</i> option checked.
<i>Refresh</i>	Set the refresh rate used for graphs, plain text data, etc. Can be set to 0 to disable. Time suffixes are supported, e.g. 90s, 5m, 1h.
<i>Rows per page</i>	You can determine how many rows per page will be displayed in lists.
<i>URL (after login)</i>	You can make Zabbix transfer the user to a specific URL after successful login, for example, to <i>Problems</i> page.

User media

The *Media* tab contains a listing of all media defined for the user. Media are used for sending notifications.

User						
Media 2						
Permissions						
Media	Type	Send to	When active	Use if severity	Status	Action
	Email 	example@zabbix.com	1-7,00:00-24:00	N I W A H D	Disabled	Edit Remove
	Gmail	example@gmail.com	1-7,00:00-24:00	N I W A H D	Enabled	Edit Remove
	Add					

Click on *Add* to assign media to the user.

If the media type has been disabled:

- A yellow info icon is displayed after the name.
- *Disabled* is displayed in the Status column.

See the [Media types](#) section for details on configuring user media.

Permissions

The *Permissions* tab contains information on the following elements:

- User role (mandatory for any newly created user) that can only be changed by a *Super admin* user.

Attention:

Users cannot be created without a **user role** (except with Zabbix **User API**). Previously created users which do not have a role may still be edited without assigning a role to them. However, once a role is assigned, it can only be changed, not removed.

 Note that users without a role can log into Zabbix only using **LDAP** or **SAML** authentication, provided their LDAP/SAML information matches the user group mappings configured in Zabbix.

- User type (*User*, *Admin*, *Super admin*) that is defined in the user role configuration.
- Host and template groups that the user has access to.
 - *User* and *Admin* type users, by default, do not have access to any groups, templates, and hosts. To grant such access, users must be included in user groups configured with permissions to the relevant entities.
- Access rights to sections and elements of Zabbix frontend, modules, and API methods.
 - Elements with allowed access are displayed in green color, while those with denied access - in light gray color.
- Rights to perform specific actions.
 - Actions that the user is allowed to perform are displayed in green color, while those that are denied - in light gray color.

See the [Permissions](#) page for details.

2 Permissions

Overview

Permissions in Zabbix depend on the user type, customized user roles and access to hosts, which is specified based on the user group.

User types

Permissions in Zabbix depend, primarily, on the user type:

- *User* - has limited access rights to menu sections (see below) and no access to any resources by default. Any permissions to host or template groups must be explicitly assigned;
- *Admin* - has incomplete access rights to menu sections (see below). The user has no access to any host groups by default. Any permissions to host or template groups must be explicitly given;
- *Super admin* - has access to all menu sections. The user has a read-write access to all host and template groups. Permissions cannot be revoked by denying access to specific groups.

Menu access

The following table illustrates access to Zabbix menu sections per user type:

Menu section	User	Admin	Super admin
Dashboards	+	+	+
Monitoring	+	+	+
<i>Problems</i>	+	+	+
<i>Hosts</i>	+	+	+
<i>Latest data</i>	+	+	+
<i>Maps</i>	+	+	+
<i>Discovery</i>		+	+
Services	+	+	+
<i>Services</i>	+	+	+
<i>SLA</i>		+	+
<i>SLA report</i>	+	+	+
Inventory	+	+	+
<i>Overview</i>	+	+	+
<i>Hosts</i>	+	+	+
Reports	+	+	+
<i>System information</i>			+
<i>Scheduled reports</i>		+	+
<i>Availability report</i>	+	+	+

Menu section	User	Admin	Super admin
<i>Top 100 triggers</i>	+	+	+
<i>Audit log</i>			+
<i>Action log</i>			+
<i>Notifications</i>		+	+
Data collection		+	+
<i>Template groups</i>		+	+
<i>Host groups</i>		+	+
<i>Templates</i>		+	+
<i>Hosts</i>		+	+
<i>Maintenance</i>		+	+
<i>Event correlation</i>			+
<i>Discovery</i>		+	+
Alerts		+	+
<i>Trigger actions</i>		+	+
<i>Service actions</i>		+	+
<i>Discovery actions</i>		+	+
<i>Autoregistration actions</i>		+	+
<i>Internal actions</i>		+	+
<i>Media types</i>			+
<i>Scripts</i>			+
Users			+
<i>User groups</i>			+
<i>User roles</i>			+
<i>Users</i>			+
<i>API tokens</i>			+
<i>Authentication</i>			+
Administration			+
<i>General</i>			+
<i>Audit log</i>			+
<i>Housekeeping</i>			+
<i>Proxy groups</i>			+
<i>Proxies</i>			+
<i>Macros</i>			+
<i>Queue</i>			+

User roles

User roles allow making custom adjustments to the permissions defined by the user type. While no permissions can be added (that would exceed those of the user type), some permissions can be revoked.

Furthermore, a user role determines access not only to menu sections, but also to services, modules, API methods and various actions in the frontend.

User roles are configured in the *Users* → *User roles* section by Super admin users.

User roles are assigned to users in the user configuration form, *Permissions* tab, by Super admin users.

User Media **Permissions**

* Role

User type

Permissions	Group	Type	Permissions
	All groups	Hosts	None
	All groups	Templates	None

Permissions can be assigned for user groups only.

Access to UI elements

Dashboards

Monitoring

Services

Inventory

Reports

Data collection

Alerts

Access to services

Read-write access to services

Read-only access to services

Access to modules

Access to API

Access to actions

Access to hosts

Access to any host and template data in Zabbix is granted to **user groups** on the host/template group level only.

That means that an individual user cannot be directly granted access to a host (or host group). It can only be granted access to a host by being part of a user group that is granted access to the host group that contains the host.

Similarly, a user can only be granted access to a template by being part of a user group that is granted access to the template group that contains the template.

3 User groups

Overview

User groups allow to group users both for organizational purposes and for assigning permissions to data. Permissions to viewing and configuring data of host groups and template groups are assigned to user groups, not individual users.

It may often make sense to separate what information is available for one group of users and what - for another. This can be accomplished by grouping users and then assigning varied permissions to host and template groups.

A user can belong to any number of groups.

Configuration

To configure a user group:

- Go to *Users* → *User groups*
- Click on *Create user group* (or on the group name to edit an existing group)
- Edit group attributes in the form

The **User group** tab contains general group attributes:

All mandatory input fields are marked with a red asterisk.

Parameter	Description
<i>Group name</i>	Unique group name.
<i>Users</i>	To add users to the group start typing the name of an existing user. When the dropdown with matching user names appears, scroll down to select. Alternatively you may click the <i>Select</i> button to select users in a popup.
<i>Frontend access</i>	How the users of the group are authenticated. System default - use default authentication method (set globally) Internal - use Zabbix internal authentication (even if LDAP authentication is used globally). Ignored if HTTP authentication is the global default. LDAP - use LDAP authentication (even if internal authentication is used globally). Ignored if HTTP authentication is the global default. Disabled - access to Zabbix frontend is forbidden for this group
<i>LDAP server</i>	Select which LDAP server to use to authenticate the user.
<i>Multi-factor authentication</i>	This field is enabled only if <i>Frontend access</i> is set to LDAP or System default. Select which multi-factor authentication method to use to authenticate the user: Default - use the method set as default in MFA configuration; this option is selected by default for new user groups if MFA is enabled; <Method name> - use selected method (for example, "Zabbix TOTP"); Disabled - MFA is disabled for this group; this option is selected by default for new user groups if MFA is disabled. Note that if a user belongs to multiple user groups with MFA enabled (or at least one group has MFA enabled), the following authentication rules apply: if any group uses the "Default" MFA method, it will authenticate the user; otherwise, the first method (ordered alphabetically) will be used for authentication.
<i>Enabled</i>	Status of user group and group members. <i>Checked</i> - user group and users are enabled <i>Unchecked</i> - user group and users are disabled
<i>Debug mode</i>	Mark this checkbox to activate debug mode for the users.

The **Template permissions** tab allows specifying user group access to template group (and thereby template) data:

The **Host permissions** tab allows specifying user group access to host group (and thereby host) data:

Click on [Add](#) to choose the template/host groups (be it a parent or a nested group) and assign permissions to those. Start typing the group name (a dropdown of matching groups will appear) or click on *Select* for a popup window listing all groups to be opened.

Then use the option buttons to assign permissions to the chosen groups. Possible permissions are the following:

- **Read-write** - read-write access to a group;
- **Read** - read-only access to a group;
- **Deny** - access to a group denied.

If the same template/host group is added in several rows with different permissions set, the strictest permission will be applied.

Note that a *Super admin* user can enforce nested groups to have the same level of permissions as the parent group; this can be done in the **host/template** group configuration form.

Template permissions and **Host permissions** tabs support the same set of parameters.

Current permissions to groups are displayed in the *Permissions* block, and those can be modified or removed.

Note:

If a user group has **Read-write** permissions to a host and **Deny** or no permissions to a template linked to this host, the users of such group will not be able to edit templated items on the host, and template name will be displayed as *Inaccessible template*.

The **Problem tag filter** tab allows setting tag-based permissions for user groups to see problems filtered by tag name and value:

Click on [Add](#) to choose the host groups. To select a host group to apply a tag filter for, click *Select* to get the complete list of existing host groups or start typing the name of a host group to get a dropdown of matching groups. Only host groups will be displayed, because problem tag filter cannot be applied to template groups.

Then it is possible to switch from *All tags* to *Tag list* in order to set particular tags and their values for filtering. Tag names without values can be added, but values without names cannot. Only the first three tags (with values, if any) are displayed in the

Permissions block; if there are more, those can be seen by clicking or hovering over the **...** icon.

Tag filter allows separating the access to host group from the possibility to see problems.

For example, if a database administrator needs to see only "MySQL" database problems, it is required to create a user group for database administrators first, then specify "target" tag name and "mysql" value.

If "target" tag name is specified and value field is left blank, the user group will see all problems with tag name "target" for the selected host group. If *All tags* is selected, the user group will see all problems for the specified host group.

Make sure tag name and tag value are correctly specified, otherwise, the user group will not see any problems.

Let's review an example when a user is a member of several user groups selected. Filtering in this case will use OR condition for tags.

User group A			User group B			Visible result for a user (member) of both groups
Host group	Tag name	Tag value	Host group	Tag name	Tag value	
Databases	target	mysql	Databases	target	oracle	target:mysql or target:oracle problems visible
Databases	set to: <i>All tags</i>		Databases	target	oracle	All problems visible
Not configured in the Problem tag filter			Databases	target	oracle	target:oracle problems visible

Attention: Adding a filter (for example, all tags in a certain host group "Databases") results in not being able to see the problems of other host groups.

Access from several user groups

A user may belong to any number of user groups. These groups may have different access permissions to hosts or templates.

Therefore, it is important to know what entities an unprivileged user will be able to access as a result. For example, let us consider how access to host **X** (in Hostgroup 1) will be affected in various situations for a user who is in user groups A and B.

- If Group A has only *Read* access to Hostgroup 1, but Group B *Read-write* access to Hostgroup 1, the user will get **Read-write** access to 'X'.

Attention: "Read-write" permissions have precedence over "Read" permissions.

- In the same scenario as above, if 'X' is simultaneously also in Hostgroup 2 that is **denied** to Group A or B, access to 'X' will be **unavailable**, despite a *Read-write* access to Hostgroup 1.
- If Group A has no permissions defined and Group B has a *Read-write* access to Hostgroup 1, the user will get **Read-write** access to 'X'.
- If Group A has *Deny* access to Hostgroup 1 and Group B has a *Read-write* access to Hostgroup 1, the user will get access to 'X' **denied**.

Other details

- An Admin level user with *Read-write* access to a host will not be able to link/unlink templates, if he has no access to the template group they belong to. With *Read* access to the template group he will be able to link/unlink templates to the host, however, will not see any templates in the template list and will not be able to operate with templates in other places.
- An Admin level user with *Read* access to a host will not see the host in the configuration section host list; however, the host triggers will be accessible in IT service configuration.
- Any non-Super Admin user (including 'guest') can see network maps as long as the map is empty or has only images. When hosts, host groups or triggers are added to the map, permissions are respected.
- Zabbix server will not send notifications to users defined as action operation recipients if access to the concerned host is explicitly "denied".

13 Storage of secrets

Overview Zabbix can be configured to retrieve sensitive information from a secure vault. The following secret management services are supported: HashiCorp Vault KV Secrets Engine - Version 2, CyberArk Vault CV12.

Secrets can be used for retrieving:

- [user macro values](#)
- [database access credentials](#)

Zabbix provides read-only access to the secrets in a vault, assuming that secrets are managed by someone else.

For information about specific vault provider configuration, see:

- [HashiCorp configuration](#)
- [CyberArk configuration](#)

Caching of secret values Vault secret macro values are retrieved by Zabbix server on every refresh of configuration data and then stored in the configuration cache. Zabbix proxy receives values of vault secret macros from Zabbix server on each configuration sync and stores them in its own configuration cache.

Attention:

Encryption must be enabled between Zabbix server and proxy; otherwise a server warning message is logged.

To manually trigger refresh of cached secret values from a vault, use the 'secrets_reload' command-line [option](#).

For Zabbix frontend database credentials caching is disabled by default, but can be enabled by setting the option `$DB['VAULT_CACHE'] = true` in `zabbix.conf.php`. The credentials will be stored in a local cache using the filesystem temporary file directory. The web server must allow writing in a private temporary folder (for example, for Apache the configuration option `PrivateTmp=True` must be set). To control how often the data cache is refreshed/invalidated, use the `ZBX_DATA_CACHE_TTL` [constant](#) .

TLS configuration To configure TLS for communication between Zabbix components and the vault, add a certificate signed by a certificate authority (CA) to the system-wide default CA store. To use another location, specify the directory in the `SSLCAlocation` Zabbix [server/proxy](#) configuration parameter, place the certificate file inside that directory, then run the CLI [command](#):

```
c_rehash .
```

1 CyberArk configuration

This section explains how to configure Zabbix to retrieve secrets from CyberArk Vault CV12.

The vault should be installed and configured as described in the official [CyberArk documentation](#).

To learn about configuring TLS in Zabbix, see [Storage of secrets](#).

Database credentials

Access to a secret with database credentials is configured for each Zabbix component separately.

Server and proxies

To obtain database credentials from the vault for Zabbix **server** or **proxy**, specify the following configuration parameters in the configuration file:

- **Vault** - which vault provider should be used;
- **VaultURL** - vault server HTTP[S] URL;
- **VaultDBPath** - query to the vault secret containing database credentials which will be retrieved by keys "Content" and "UserName";
- **VaultTLSCertFile**, **VaultTLSKeyFile** - SSL certificate and key file names; setting up these options is not mandatory, but highly recommended;
- **VaultPrefix** - custom prefix for the vault path or query, depending on the vault; if not specified, the most suitable default will be used.

Attention:

Zabbix server also uses the **Vault**, **VaultURL**, **VaultTLSCertFile** and **VaultTLSKeyFile**, and **VaultPrefix** configuration parameters for vault authentication when processing vault secret macros.

Zabbix server and Zabbix proxy read the vault-related configuration parameters from *zabbix_server.conf* and *zabbix_proxy.conf* files upon startup.

Example

1. In *zabbix_server.conf*, specify the following parameters:

```
Vault=CyberArk
VaultURL=https://127.0.0.1:1858
VaultDBPath=AppID=zabbix_server&Query=Safe=passwordSafe;Object=zabbix_server_database
VaultTLSCertFile=cert.pem
VaultTLSKeyFile=key.pem
VaultPrefix=/AIMWebService/api/Accounts?
```

2. Zabbix will send the following API request to the vault:

```
curl \
--header "Content type: application/json" \
--cert cert.pem \
--key key.pem \
https://127.0.0.1:1858/AIMWebService/api/Accounts?AppID=zabbix_server&Query=Safe=passwordSafe;Object=zabbix_server_database
```

3. The vault response will contain the keys "Content" and "UserName":

```
{
  "Content": <password>,
  "UserName": <username>,
  "Address": <address>,
  "Database": <Database>,
  "PasswordChangeInProgress": <PasswordChangeInProgress>
}
```

4. As a result, Zabbix will use the following credentials for database authentication:

- Username: <username>
- Password: <password>

Frontend

To obtain database credentials from the vault for Zabbix frontend, specify the following parameters during frontend **installation**.

1. At the *Configure DB Connection* step, set the *Store credentials in* parameter to "CyberArk Vault".

2. Then, fill in the additional parameters:

Parameter	Mandatory	Default value	Description
Vault API endpoint	yes	https://localhost:1858	Specify the URL for connecting to the vault in the format <code>scheme://host:port</code>
Vault prefix	no	/AIMWebService/api/Accounts?	Provide a custom prefix for the vault path or query. If not specified, the default is used.
Vault secret query string	yes		A query, which specifies from where database credentials should be retrieved. Example: <code>AppID=foo&Query=Safe=bar;Object=buzz</code>
Vault certificates	no		After marking the checkbox, additional parameters will appear allowing to configure client authentication. While this parameter is optional, it is highly recommended to enable it for communication with the CyberArk Vault.
SSL certificate file	no	conf/certs/cyberark-cert.pem	Path to the SSL certificate file. The file must be in PEM format. If the certificate file also contains the private key, leave the SSL key file parameter empty.
SSL key file	no	conf/certs/cyberark-key.pem	Name of the SSL private key file used for client authentication. The file must be in PEM format.

User macro values

To use CyberArk Vault for storing *Vault secret* user macro values, make sure that:

- Zabbix server is **configured** to work with CyberArk Vault;
- the *Vault provider* parameter in *Administration* → *General* → *Other* is set to "CyberArk Vault".

Storage of secrets

Vault provider HashiCorp Vault CyberArk Vault

Note:

Only Zabbix server requires access to *Vault secret* macro values from the vault. Other Zabbix components (proxy, frontend) do not need such access.

The macro value should contain a query (as `query:key`).

See *Vault secret macros* for detailed information on macro value processing by Zabbix.

Query syntax

The colon symbol (":") is reserved for separating the query from the key.

If a query itself contains a forward slash or a colon, these symbols should be URL-encoded ("/" is encoded as "%2F", ":" is encoded as "%3A").

Example

1. In Zabbix, add a user macro {\$PASSWORD} of type *Vault secret* and with the value `AppID=zabbix_server&Query=Safe=passwordS`

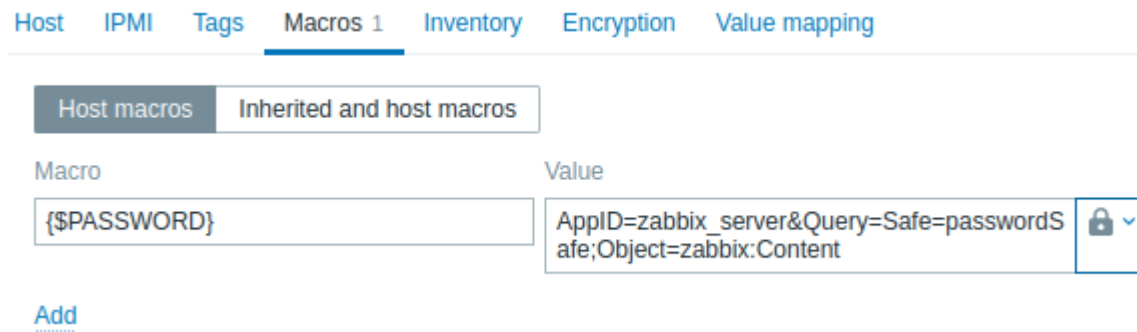

2. Zabbix will send the following API request to the vault:

```
curl \
--header "Content type: application/json" \
--cert cert.pem \
--key key.pem \
https://127.0.0.1:1858/AIMWebService/api/Accounts?AppID=zabbix_server&Query=Safe=passwordSafe;Object=zabbix
```

3. The vault response will contain the key "Content":

```
{
  "Content": <password>,
  "UserName": <username>,
  "Address": <address>,
  "Database" : <Database>,
  "PasswordChangeInProgress": <PasswordChangeInProgress>
}
```

4. As a result, Zabbix will resolve the macro {\$PASSWORD} to the value - <password>

Update existing configuration

To update an existing configuration for retrieving secrets from a CyberArk Vault:

1. Update the Zabbix server or proxy configuration file parameters as described in the *Database credentials* section.
2. Update the DB connection settings by reconfiguring Zabbix frontend and specifying the required parameters as described in the *Frontend* section. To reconfigure Zabbix frontend, open the frontend setup URL in the browser:
 - for Apache: `http://<server_ip_or_name>/zabbix/setup.php`
 - for Nginx: `http://<server_ip_or_name>/setup.php`

Alternatively, these parameters can be set in the *frontend configuration file* (`zabbix.conf.php`):

```
$DB['VAULT']           = 'CyberArk';
$DB['VAULT_URL']       = 'https://127.0.0.1:1858';
$DB['VAULT_DB_PATH']   = 'AppID=foo&Query=Safe=bar;Object=buzz';
$DB['VAULT_TOKEN']     = '';
$DB['VAULT_CERT_FILE'] = 'conf/certs/cyberark-cert.pem';
$DB['VAULT_KEY_FILE']  = 'conf/certs/cyberark-key.pem';
$DB['VAULT_PREFIX']    = '';
```

3. Configure user macros as described in the *User macro values* section, if necessary.

To update an existing configuration for retrieving secrets from a HashiCorp Vault, see *HashiCorp configuration*.

2 HashiCorp configuration

Overview

This section explains how to configure Zabbix for retrieving secrets from HashiCorp Vault KV Secrets Engine - Version 2.

The vault should be deployed and configured as described in the official [HashiCorp documentation](#).

To learn about configuring TLS in Zabbix, see [Storage of secrets](#).

Retrieving database credentials

To retrieve a secret with database credentials successfully, it is required to configure both:

- Zabbix server/proxy
- Zabbix frontend

Server/proxy

To configure Zabbix **server** or **proxy**, specify the following configuration parameters in the configuration file:

- `Vault` - which vault provider should be used;
- `VaultToken` - vault authentication token (see Zabbix server/proxy configuration file for details);
- `VaultURL` - vault server HTTP[S] URL;
- `VaultDBPath` - path to the vault secret containing database credentials; Zabbix server or proxy will retrieve the credentials by keys "password" and "username";
- `VaultPrefix` - custom prefix for the vault path or query, depending on the vault; if not specified, the most suitable default will be used.

Attention:

Zabbix server also uses the `Vault`, `VaultToken`, `VaultURL`, and `VaultPrefix` configuration parameters for vault authentication when processing vault secret macros.

Zabbix server and Zabbix proxy read the vault-related configuration parameters from `zabbix_server.conf` and `zabbix_proxy.conf` upon startup. Additionally, Zabbix server and Zabbix proxy will read the `VAULT_TOKEN` environment variable once during startup and will unset it so that it would not be available through forked scripts; it is an error if both `VaultToken` and `VAULT_TOKEN` parameters contain a value.

Example

1. In `zabbix_server.conf`, specify the following parameters:

```
Vault=HashiCorp
VaultToken=hvs.CAESIIG_PILmULFY0sEyWHxkZ2mF2a8VPKNLE8eHqd4autYGGh4KHGh2cy5aeTYONFNsaUp3ZnpWbDF1RUNjUkNTZEg
VaultURL=https://127.0.0.1:8200
VaultDBPath=secret/zabbix/database
VaultPrefix=/v1/secret/data/
```

2. Run the following CLI commands to create the required secret in the vault:

```
#### Enable "secret/" mount point if not already enabled; note that "kv-v2" must be used.
vault secrets enable -path=secret/ kv-v2

#### Put new secrets with keys username and password under mount point "secret/" and path "zabbix/database"
vault kv put -mount=secret zabbix/database username=zabbix password=<password>

#### Test that secret is successfully added.
vault kv get secret/zabbix/database

#### Finally test with Curl; note that "data" need to be manually added after mount point and "/v1" before
curl --header "X-Vault-Token: <VaultToken>" https://127.0.0.1:8200/v1/secret/data/zabbix/database
```

3. As a result, Zabbix server will retrieve the following credentials for database authentication:

- Username: zabbix
- Password: <password>

Frontend

Zabbix frontend can be configured to retrieve database credentials from the vault either during frontend **installation** or by updating the frontend configuration file (`zabbix.conf.php`).

Attention:

If vault credentials have been changed since the previous frontend installation, rerun the frontend installation or update `zabbix.conf.php`. See also: [Updating existing configuration](#).

During **frontend installation** the configuration parameters must be specified at the *Configure DB Connection* step:

- Set the *Store credentials in* parameter to "HashiCorp Vault".
- Specify the connection parameters:

Parameter	Mandatory	Default value	Description
<i>Vault API endpoint</i>	yes	https://localhost:8200	Specify the URL for connecting to the vault in the format <code>scheme://host:port</code>
<i>Vault prefix</i>	no	/v1/secret/data/	Provide a custom prefix for the vault path or query. If not specified, the default is used.
<i>Vault secret path</i>	no		A path to the secret from where credentials for the database shall be retrieved by the keys "password" and "username". Example: <code>secret/zabbix/database</code>
<i>Vault authentication token</i>	no		Provide an authentication token for read-only access to the secret path. See HashiCorp documentation for information about creating tokens and vault policies.

Retrieving user macro values

To use HashiCorp Vault for storing *Vault secret* user macro values, make sure that:

- Zabbix server is **configured** to work with HashiCorp Vault;
- the *Vault provider* parameter in *Administration* → *General* → *Other* is set to "HashiCorp Vault" (default).

Storage of secrets

Vault provider HashiCorp Vault CyberArk Vault

Note:

Only Zabbix server requires access to *Vault secret* macro values from the vault. Other Zabbix components (proxy, frontend) do not need such access.

The macro value should contain a reference path (as `path:key`, for example, `secret/zabbix:password`). The authentication token specified during Zabbix server configuration (by the `VaultToken` parameter) must provide read-only access to this path.

See *Vault secret macros* for detailed information on macro value processing by Zabbix.

Path syntax

The symbols forward slash ("/") and colon (":") are reserved.

A forward slash can only be used to separate a mount point from a path (e.g., `secret/zabbix` where the mount point is "secret" and the path is "zabbix"). In the case of Vault macros, a colon can only be used to separate a path/query from a key.

It is possible to URL-encode the forward slash and colon symbols if there is a need to create a mount point with the name that is separated by a forward slash (e.g., `foo/bar/zabbix`, where the mount point is "foo/bar" and the path is "zabbix", can be encoded as "foo%2Fbar/zabbix") and if a mount point name or path need to contain a colon.

Example

1. In Zabbix, add a user macro `{$PASSWORD}` of type "Vault secret" and with the value `secret/zabbix:password`

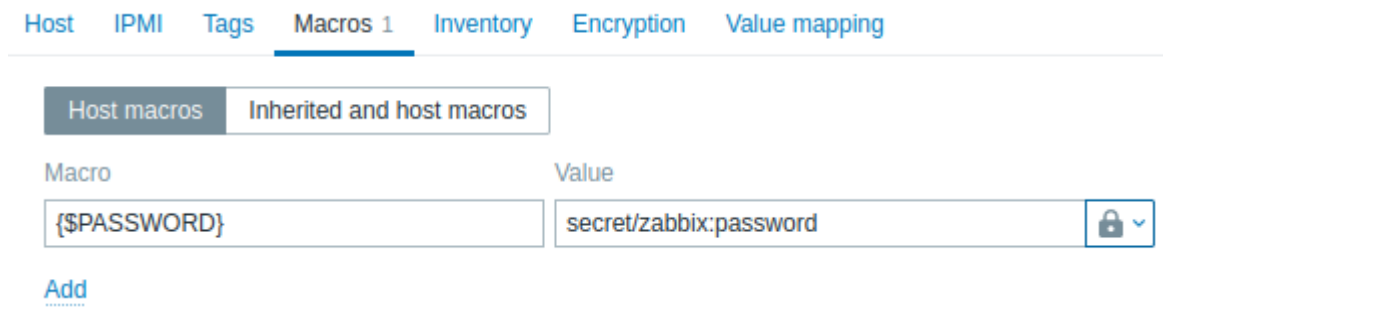

2. Run the following CLI commands to create required secret in the vault:

```
#### Enable "secret/" mount point if not already enabled; note that "kv-v2" must be used.
vault secrets enable -path=secret/ kv-v2

#### Put new secret with key password under mount point "secret/" and path "zabbix".
vault kv put -mount=secret zabbix password=<password>

#### Test that secret is successfully added.
vault kv get secret/zabbix

#### Finally test with Curl; note that "data" need to be manually added after mount point and "/v1" before
curl --header "X-Vault-Token: <VaultToken>" https://127.0.0.1:8200/v1/secret/data/zabbix
```

3. As a result, Zabbix will resolve the macro `{$PASSWORD}` to the value: `<password>`

Updating existing configuration

To update an existing configuration for retrieving secrets from a HashiCorp Vault:

1. Update the Zabbix server or proxy configuration file parameters as described in the *Database credentials* section.
2. Update the DB connection settings by reconfiguring Zabbix frontend and specifying the required parameters as described in the *Frontend* section. To reconfigure Zabbix frontend, open the frontend setup URL in the browser:
 - for Apache: `http://<server_ip_or_name>/zabbix/setup.php`
 - for Nginx: `http://<server_ip_or_name>/setup.php`

Alternatively, these parameters can be set in the *frontend configuration file* (`zabbix.conf.php`):

```
$DB['VAULT']           = 'HashiCorp';
$DB['VAULT_URL']       = 'https://localhost:8200';
$DB['VAULT_DB_PATH']   = 'secret/zabbix/database';
$DB['VAULT_TOKEN']     = '<mytoken>';
$DB['VAULT_CERT_FILE'] = '';
$DB['VAULT_KEY_FILE']  = '';
$DB['VAULT_PREFIX']    = '';
```

3. Configure user macros as described in the *User macro values* section, if necessary.

To update an existing configuration for retrieving secrets from a CyberArk Vault, see *CyberArk configuration*.

14 Scheduled reports

Overview

With the *Scheduled reports* feature, you can set up a PDF version of a given dashboard to be sent to specified recipients at recurring intervals.

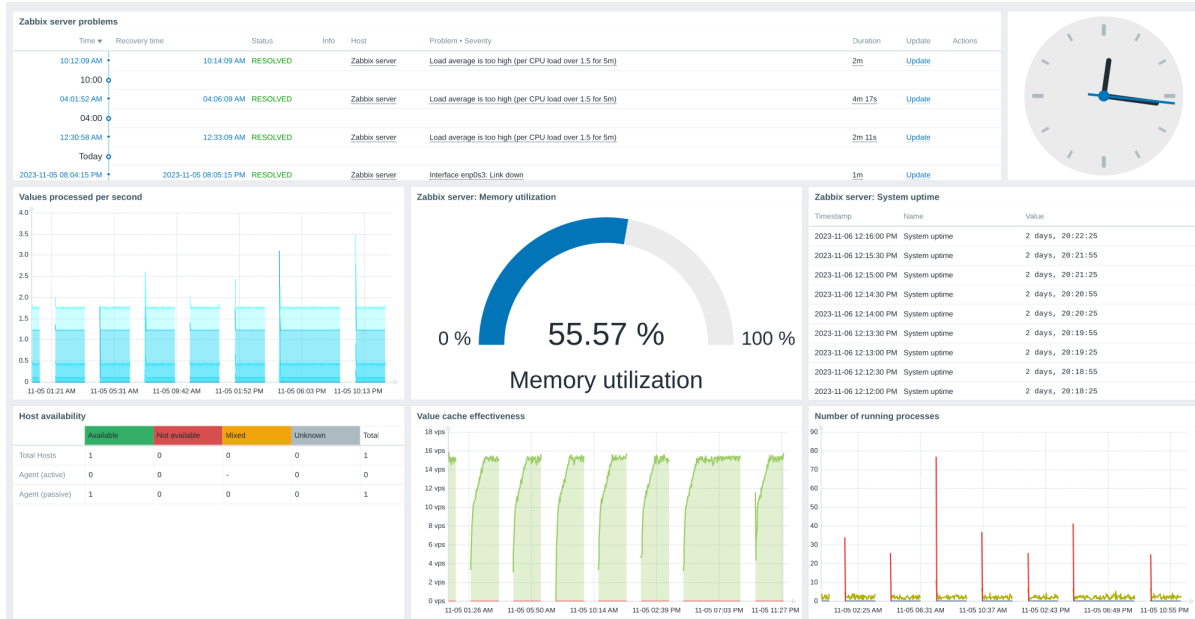

Pre-requisites:

- Zabbix web service must be installed and configured correctly to enable scheduled report generation - see [Setting up scheduled reports](#) for instructions.
- A user must have a **user role** of type *Admin* or *Super admin* with the following permissions:
 - *Scheduled reports* in the *Access to UI elements* block (to view reports)
 - *Manage scheduled reports* in the *Access to actions* block (to create/edit reports)

To create a scheduled report in Zabbix frontend, do the following:

- Go to: *Reports* → *Scheduled reports*
- Click *Create report* in the upper right corner of the screen
- Enter parameters of the report in the form

You can also create a report by opening an existing one, clicking the *Clone* button, and then saving it under a different name.

Configuration

The *Scheduled reports* tab contains general report attributes.

* Owner

* Name

* Dashboard

Period

Cycle

Start time :

Start date

End date

Subject

Message

* Subscriptions

Recipient	Generate report by	Status	Action
Admin (Zabbix Administra...	Admin (Zabbix Administra...	Include	Remove
Add user Add user group			

Description

Enabled

All mandatory input fields are marked with a red asterisk.

Parameter	Description
<i>Owner</i>	User that creates a report. <i>Super admin</i> level users are allowed to change the owner. For <i>Admin</i> level users, this field is read-only.
<i>Name</i>	Name of the report; must be unique.
<i>Dashboard</i>	Dashboard on which the report is based; only one dashboard can be selected at a time. To select a dashboard, start typing the name - a list of matching dashboards will appear; scroll down to select. Alternatively, you may click <i>Select</i> next to the field and select a dashboard from the displayed list.
<i>Period</i>	Period for which the report will be prepared. Select the previous day, week, month, or year.
<i>Cycle</i>	Report generation frequency. The reports can be sent daily, weekly, monthly, or yearly. "Weekly" mode allows to select days of the week when the report will be sent.
<i>Start time</i>	Time of the day in the format hh:mm when the report will be prepared. Note that Zabbix server time zone will be used.
<i>Repeat on</i>	Days of the week when the report will be sent. This field is available only if <i>Cycle</i> is set to "Weekly".

Parameter	Description
<i>Start date</i>	Date when regular report generation should be started.
<i>End date</i>	Date when regular report generation should be stopped.
<i>Subject</i>	Subject of the report email. Supported macros: {TIME}, {TIMESTAMP}.
<i>Message</i>	Body of the report email. Supported macros: {TIME}, {TIMESTAMP}.
<i>Subscriptions</i>	<p>List of report recipients. By default, includes only the report owner. Any Zabbix user with configured email media may be specified as a report recipient.</p> <p>Click <i>Add user</i> or <i>Add user group</i> to add more recipients.</p> <p>Click the username to edit settings:</p> <p><i>Generate report by</i> - whether the report data should be generated based on the dashboard permissions of the current user or the recipient.</p> <p><i>Status</i> - select "Include" to send the report to the user or "Exclude" to prevent sending the report to this user. At least one user must have the "Include" status. The "Exclude" status can be used to exclude specific users from a user group that is included.</p> <p>Note that users with insufficient permissions (that is, users with a role based on the <i>Admin</i> user type who are not members of the same user group as the recipient or report owner) will see "Inaccessible user" or "Inaccessible user group" instead of the actual names in the fields <i>Recipient</i> and <i>Generate report by</i>; the fields <i>Status</i> and <i>Action</i> will be displayed as read-only.</p>
<i>Enabled</i>	Report status. Clearing this checkbox will disable the report.
<i>Description</i>	An optional description of the report. This description is for internal use and will not be sent to report recipients.

Form buttons

Buttons at the bottom of the form allow to perform several operations.

Add	Add a report. This button is only available for new reports.
Update	Update the properties of a report.
Clone	Create another report based on the properties of the current report.
Test	Test if report configuration is correct by sending a report to the current user.
Delete	Delete the report.
Cancel	Cancel the editing of report properties.

Testing

To test a report, click the *Test* button at the bottom of the report configuration form.

Note:

The *Test* button is not available if the report configuration form has been opened from the dashboard **action menu**.

If the configuration is correct, the test report is sent immediately to the current user. For test reports, subscribers and *Generate report by* user settings are ignored.

If the configuration is incorrect, an error message is displayed describing the possible cause.

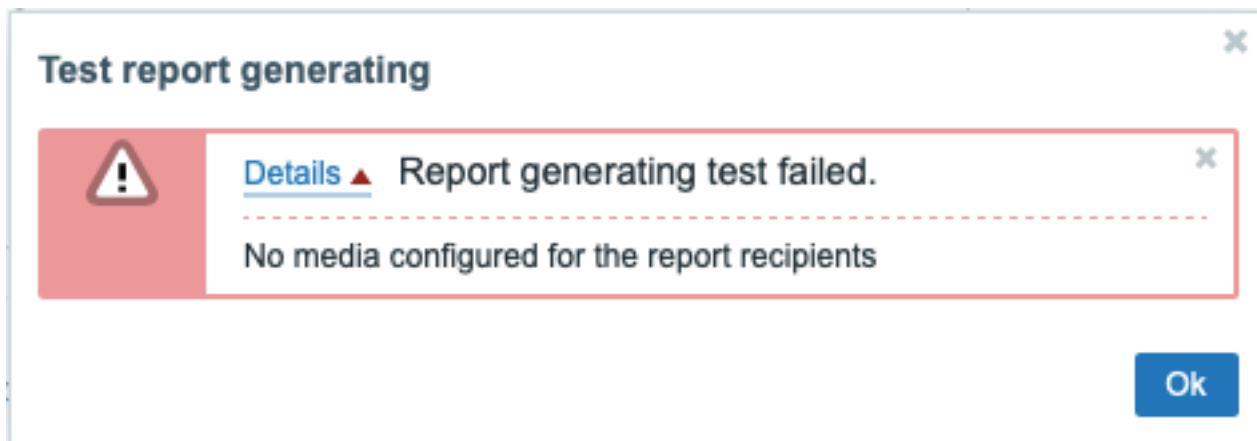

Updating a report

To update an existing report, click the report name, make the required configuration changes, and then click the *Update* button.

If an existing report is updated by another user and this user changes the Dashboard, upon clicking the *Update* button, a warning message "Report generated by other users will be changed to the current user" will be displayed.

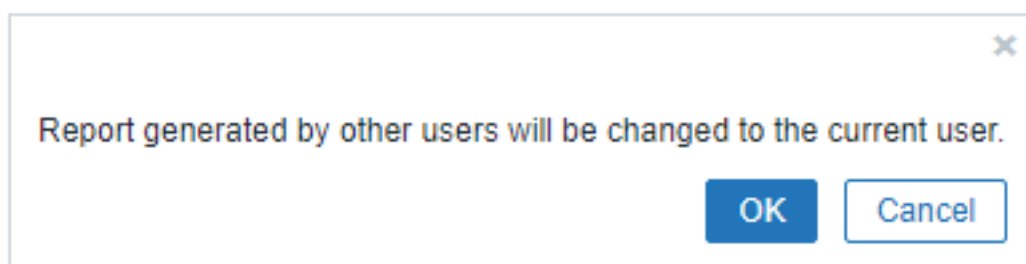

Clicking *OK* at this step will lead to the following changes:

- *Generate report by* settings will be updated to display the user who edited the report last (unless *Generate report by* is set to the recipient).
- Users that have been displayed as "Inaccessible user" or "Inaccessible user group" will be deleted from the list of report subscribers.

Clicking *Cancel* will close the configuration form and cancel the report update.

Cloning a report

To quickly clone an existing report, click the *Clone* button at the bottom of an existing report configuration form. When cloning a report created by another user, the current user becomes the owner of the new report.

Report settings will be copied to the new report configuration form with respect to user permissions:

- If the user who clones a report has no permissions to a dashboard, the *Dashboard* field will be cleared.
- If the user who clones a report has no permissions to some users or user groups in the *Subscriptions* list, inaccessible recipients will not be cloned.
- *Generate report by* settings will be updated to display the current user (unless *Generate report by* is set to the recipient).

Change the required settings and the report name, then click *Add*.

15 Data export

Overview

Zabbix supports data export in real-time in two ways:

- **export to files**
- **streaming to external systems**

The following entities can be exported:

- trigger events
- item values
- trends (export to files only)

1 Export to files

Overview

It is possible to configure real-time exporting of trigger events, item values and trends in a newline-delimited JSON format.

Exporting is done into files, where each line of the export file is a JSON object. Value mappings are not applied.

In case of errors (data cannot be written to the export file or the export file cannot be renamed or a new one cannot be created after renaming it), the data item is dropped and never written to the export file. It is written only in the Zabbix database. Writing data to the export file is resumed when the writing problem is resolved.

For precise details on what information is exported, see the [export protocol](#) page.

Note that host/item can have no metadata (host groups, host name, item name) if the host/item was removed after the data was received, but before server exported data.

Configuration

Real-time export of trigger events, item values and trends is configured by specifying a directory for the export files - see the [ExportDir](#) parameter in server configuration.

Two other parameters are available:

- `ExportFileSize` may be used to set the maximum allowed size of an individual export file. When a process needs to write to a file it checks the size of the file first. If it exceeds the configured size limit, the file is renamed by appending `.old` to its name and a new file with the original name is created.

Attention:

A file will be created per each process that will write data (i.e. approximately 4-30 files). As the default size per export file is 1G, keeping large export files may drain the disk space fast.

- `ExportType` allows to specify which entity types (events, history, trends) will be exported.

2 Streaming to external systems

Overview

It is possible to stream item values and events from Zabbix to external systems over HTTP (see [protocol details](#)).

The tag filter can be used to stream subsets of item values or events.

Two Zabbix server processes are responsible for data streaming: `connector manager` and `connector worker`. A Zabbix internal item `zabbix[connector_queue]` allows to monitor the count of values enqueued in the connector queue.

Configuration

The following steps are required to configure data streaming to an external system:

1. Have a remote system set up for receiving data from Zabbix. For this purpose, the following tools are available:
 - An example of a simple [receiver](#) that logs the received information in `events.ndjson` and `history.ndjson` files.
 - [Kafka connector for Zabbix server](#) - a lightweight server written in Go, designed to forward item values and events from a Zabbix server to a Kafka broker.
2. Set the required number of connector workers in Zabbix by adjusting the `StartConnectors` parameter in `zabbix_server.conf`. The number of connector workers should match (or exceed if concurrent sessions are more than 1) the configured connector count in Zabbix frontend. Then, restart Zabbix server.
3. Configure a new connector in Zabbix frontend (*Administration* → *General* → *Connectors*) and reload the server cache with the `zabbix_server -R config_cache_reload` command.

New connector
? X

* Name

Protocol Zabbix Streaming Protocol v1.0

Data type

* URL

Tag filter

Equals

[Remove](#)

[Add](#)

* Type of information

Numeric (unsigned)
 Numeric (float)

Character
 Log

Text
 Binary

HTTP authentication

Advanced configuration

* Max records per message

* Concurrent sessions

* Attempts

* Attempt interval

* Timeout

HTTP proxy

SSL verify peer

SSL verify host

SSL certificate file

SSL key file

SSL key password

Description

Enabled

Mandatory fields are marked by an asterisk.

Parameter	Description
<i>Name</i>	Enter the connector name.
<i>Data type</i>	Select the data type to stream: Item values - stream item values from Zabbix to external systems; Events - stream events from Zabbix to external systems.
<i>URL</i>	Enter the receiver URL. User macros are supported.

Parameter	Description
<i>Tag filter</i>	<p>Export only item values or events matching the tag filter. If not set, then export everything. It is possible to include as well as exclude specific tags and tag values. Several conditions can be set. Tag name matching is always case-sensitive.</p> <p>There are several operators available for each condition: Exists - include the specified tag names; Equals - include the specified tag names and values (case-sensitive); Contains - include the specified tag names where the tag values contain the entered string (substring match, case-insensitive); Does not exist - exclude the specified tag names; Does not equal - exclude the specified tag names and values (case-sensitive); Does not contain - exclude the specified tag names where the tag values contain the entered string (substring match, case-insensitive).</p> <p>There are two calculation types for conditions: And/Or - all conditions must be met, conditions having the same tag name will be grouped by the Or condition; Or - enough if one condition is met.</p>
<i>Type of information</i>	<p>Select the type of information (numeric (unsigned), numeric (float), character, etc.), by which to filter the item values that the connector should stream. This field is available if <i>Data type</i> is set to "Item values".</p>
<i>HTTP authentication</i>	<p>Select the authentication option: None - no authentication used; Basic - basic authentication is used; NTLM - NTLM (Windows NT LAN Manager) authentication is used; Kerberos - Kerberos authentication is used (see also: Configuring Kerberos with Zabbix); Digest - Digest authentication is used; Bearer - Bearer authentication is used.</p>
<i>Username</i>	<p>Enter the user name (up to 255 characters). User macros are supported. This field is available if <i>HTTP authentication</i> is set to "Basic", "NTLM", "Kerberos", or "Digest".</p>
<i>Password</i>	<p>Enter the user password (up to 255 characters). User macros are supported. This field is available if <i>HTTP authentication</i> is set to "Basic", "NTLM", "Kerberos", or "Digest".</p>
<i>Bearer token</i>	<p>Enter the Bearer token. User macros are supported. This field is available and required if <i>HTTP authentication</i> is set to "Bearer".</p>
<i>Advanced configuration</i>	<p>Click the <i>Advanced configuration</i> label to display advanced configuration options (see below).</p>
<i>Max records per message</i>	<p>Specify the maximum number of values or events that can be streamed within one message.</p>
<i>Concurrent sessions</i>	<p>Select the number of sender processes to run for this connector. Up to 100 sessions can be specified; the default value is "1".</p>
<i>Attempts</i>	<p>Number of attempts for streaming data. Up to 5 attempts can be specified; the default value is "1".</p>
<i>Attempt interval</i>	<p>Specify how long the connector should wait after an unsuccessful attempt to stream data. Up to 10s can be specified; the default value is "5s". This field is available if <i>Attempts</i> is set to "2" or more. Unsuccessful attempts are those where establishing a connection has failed, or where the HTTP response code is not 200, 201, 202, 203, 204. Retries are triggered in case of communication errors or when the HTTP response code is not 200, 201, 202, 203, 204, 400, 401, 403, 404, 405, 415, 422. Redirects are followed, so 302 -> 200 is a positive response; whereas 302 -> 503 will trigger a retry.</p>
<i>Timeout</i>	<p>Specify the message timeout (1-60 seconds, default - 5 seconds). Time suffixes are supported, e.g., 30s, 1m. User macros are supported.</p>

Parameter	Description
<i>HTTP proxy</i>	<p>You can specify an HTTP proxy to use in the following format: <code>[protocol://] [username[:password]@]proxy.example.com[:port]</code> User macros are supported.</p> <p>The optional <code>protocol://</code> prefix may be used to specify alternative proxy protocols (the protocol prefix support was added in cURL 7.21.7). With no protocol specified, the proxy will be treated as an HTTP proxy. By default, 1080 port will be used.</p> <p>If <i>HTTP proxy</i> is specified, the proxy will overwrite proxy related environment variables like <code>http_proxy</code>, <code>HTTPS_PROXY</code>. If not specified, the proxy will not overwrite proxy-related environment variables. The entered value is passed on as is, no sanity checking takes place. You may also enter a SOCKS proxy address. If you specify the wrong protocol, the connection will fail and the item will become unsupported.</p>
<i>SSL verify peer</i>	<p>Note that only simple authentication is supported with HTTP proxy.</p> <p>Mark the checkbox to verify the SSL certificate of the web server. The server certificate will be automatically taken from system-wide certificate authority (CA) location. You can override the location of CA files using Zabbix server or proxy configuration parameter <code>SSLCALocation</code>.</p>
<i>SSL verify host</i>	<p>Mark the checkbox to verify that the <i>Common Name</i> field or the <i>Subject Alternate Name</i> field of the web server certificate matches. This sets the <code>CURLOPT_SSL_VERIFYHOST</code> cURL option.</p>
<i>SSL certificate file</i>	<p>Name of the SSL certificate file used for client authentication. The certificate file must be in PEM¹ format. User macros are supported. If the certificate file also contains the private key, leave the <i>SSL key file</i> field empty. If the key is encrypted, specify the password in the <i>SSL key password</i> field. The directory containing this file is specified by Zabbix server or proxy configuration parameter <code>SSLCertLocation</code>.</p>
<i>SSL key file</i>	<p>Name of the SSL private key file used for client authentication. The private key file must be in PEM¹ format. User macros are supported. The directory containing this file is specified by Zabbix server or proxy configuration parameter <code>SSLKeyLocation</code>.</p>
<i>SSL key password</i>	<p>SSL private key file password. User macros are supported.</p>
<i>Description</i>	<p>Enter the connector description.</p>
<i>Enabled</i>	<p>Mark the checkbox to enable the connector.</p>

Protocol

Communication between the server and the receiver is done over HTTP using REST API, NDJSON, "Content-Type: application/x-ndjson".

For more details, see [Newline-delimited JSON export protocol](#).

Server request

Example of streaming item values:

```
POST /v1/history HTTP/1.1
Host: localhost:8080
Accept: */*
Accept-Encoding: deflate, gzip, br, zstd
Content-Length: 628
Content-Type: application/x-ndjson
```

```
{"host":{"host":"Zabbix server","name":"Zabbix server"},"groups":["Zabbix servers"],"item_tags":[{"tag":"f
{"host":{"host":"Zabbix server","name":"Zabbix server"},"groups":["Zabbix servers"],"item_tags":[{"tag":"f
{"host":{"host":"Zabbix server","name":"Zabbix server"},"groups":["Zabbix servers"],"item_tags":[{"tag":"b
```

Example of streaming events:

```
POST /v1/events HTTP/1.1
Host: localhost:8080
Accept: */*
Accept-Encoding: deflate, gzip, br, zstd
Content-Length: 333
```

```
Content-Type: application/x-ndjson
```

```
{"clock":1673454303,"ns":800155804,"value":1,"eventid":5,"name":"trigger for foo being 0","severity":0,"host":1673454303,"p_eventid":5}
{"clock":1673454303,"ns":832290669,"value":0,"eventid":6,"p_eventid":5}
```

Receiver response

The response consists of the HTTP response status code and the JSON payload. The HTTP response status code must be "200", "201", "202", "203", or "204" for requests that were handled successfully, other for failed requests.

Example of success:

```
localhost:8080/v1/history": HTTP/1.1 200 OK
Date: Wed, 11 Jan 2023 16:40:30 GMT
Content-Length: 0
```

Example with errors:

```
localhost:8080/v1/history": HTTP/1.1 422 Unprocessable Entity
Content-Type: application/json
Date: Wed, 11 Jan 2023 17:07:36 GMT
Content-Length: 55

{"error":"invalid character '{' after top-level value"}
```

3 SNMP gateway

Overview

Zabbix SNMP gateway is an AgentX-extension for snmpd supporting both SNMP polling and trapping.

With Zabbix SNMP gateway it is possible to use the SNMP protocol to retrieve:

- trigger data;
- problem trigger data;
- host group status (count of triggers by trigger status per group)

The data is retrieved by the OID, which is a combination of a common base and a specific suffix. The common **base** is set in the configuration file of SNMP gateway, for example:

- BaseOID=1.3.6.1.4.1.3043.7.55 - for any trigger data;
- ProblemBaseOID=1.3.6.1.4.1.3047.7.55 - for problem trigger data;
- BaseOID=1.3.6.1.4.1.3046.7.55 - for host group status.

The OID **suffix** is set in the configuration on host triggers as a **tag** (for example, OIDSuffix:3) in the frontend.

In this case all information for the trigger will be available under OID=1.3.6.1.4.1.3043.7.55.X.3. "X" here will be the number of trigger data fields (i.e. 1 - suffix, 2 - ID, 3 - expression, 4 - description, etc.).

For a more detailed description and the configuration file example, see the [SNMP gateway readme file](#).

Installation and setup

See the [readme](#) file of SNMP gateway for instructions on:

- installing and configuring snmpd;
- enabling AgentX support;
- configuring Zabbix SNMP gateway;
- configuring SNMP traps for trigger state changes.

Retrieving data

With everything set up properly, you may use snmpwalk and snmpget commands to retrieve data:

```
[user@localhost ~]# snmpget -v2c -c public 127.0.0.1 1.3.6.1.4.1.3043.7.55.2.3
SNMPv2-SMI::enterprises.3043.7.55.2.3 = INTEGER: 15247
```

```
[user@localhost ~]# snmpwalk -v2c -c public 127.0.0.1 1.3.6.1.4.1.3043.7.55
SNMPv2-SMI::enterprises.3043.7.55.1.1 = INTEGER: 1
SNMPv2-SMI::enterprises.3043.7.55.1.3 = INTEGER: 3
SNMPv2-SMI::enterprises.3043.7.55.1.4 = INTEGER: 4
SNMPv2-SMI::enterprises.3043.7.55.1.5 = INTEGER: 5
```

```

SNMPv2-SMI::enterprises.3043.7.55.1.6 = INTEGER: 6
SNMPv2-SMI::enterprises.3043.7.55.1.10 = INTEGER: 10
SNMPv2-SMI::enterprises.3043.7.55.2.1 = INTEGER: 15367
SNMPv2-SMI::enterprises.3043.7.55.2.3 = INTEGER: 15247
SNMPv2-SMI::enterprises.3043.7.55.2.4 = INTEGER: 15365
SNMPv2-SMI::enterprises.3043.7.55.2.5 = INTEGER: 15366
SNMPv2-SMI::enterprises.3043.7.55.2.6 = INTEGER: 13493
SNMPv2-SMI::enterprises.3043.7.55.2.10 = INTEGER: 13503
...

```

Filtering options

You may limit the problem trigger information in SNMP gateway configuration:

- by severity (by default `ProblemMinSeverity=-1`)
- by hiding acknowledged problems (by default `ProblemHideAck=false`)

You may limit the problem count per host group in SNMP gateway configuration:

- by unknown state triggers (by default `CountUnknown=false`)
- by triggers with acknowledged/unacknowledged/all problems (by default `CountAcknowledgeStatus=all`)

8 Service monitoring

Overview Service monitoring is a business-level monitoring that can be used to get an overview of the entire IT infrastructure service tree, identify weak places of the infrastructure, calculate SLA of various IT services, and check out other information at a higher level. Service monitoring focuses on the overall availability of a service instead of low-level details, such as the lack of disk space, high processor load, etc. Service monitoring also provides functionality to find the root cause of a problem if a service is not performing as expected.

Service monitoring allows to create a hierarchy representation of monitored data.

A very simple service structure may look like:

```

Service
|
|-Workstations
| |
| |-Workstation1
| |
| |-Workstation2
|
|-Servers

```

Each node of the structure has attribute status. The status is calculated and propagated to upper levels according to the selected algorithm. The status of individual nodes is affected by the status of the mapped problems. Problem mapping is accomplished with [tagging](#).

Zabbix can send notifications or automatically execute a script on the Zabbix server in case service status change is detected. It is possible to define flexible rules whether a parent service should go into a 'Problem state' based on the statuses of child services. Services problem data can then be used to calculate SLA and send SLA reports based on the flexible set of conditions.

Service monitoring is configured in the Services menu, which consists of the following sections:

- [Services](#)

Services section allows to build a hierarchy of your monitored infrastructure by adding parent services, and then - child services to the parent services.

In addition to configuring service tree, this section provides an overview of the whole infrastructure and allows to quickly identify the problems that led to a service status change.

- [SLA](#)

In this section you can define service level agreements and set service level objectives for specific services.

- [SLA report](#)

In this section you can view SLA reports.

Service actions

You may also configure service [actions](#).

Service actions are optional and allow to:

- send a notification that a service is down
- execute a remote command on a Zabbix server upon a service status change
- send a recovery notification when a service is up again.

See also:

- SLA monitoring configuration [example](#)
- Notes about [upgrading services](#) from Zabbix versions below 6.0

1 Service tree

The service tree is configured in the *Services* -> *Services* menu section. In the upper right corner, switch from **View** to the Edit mode.

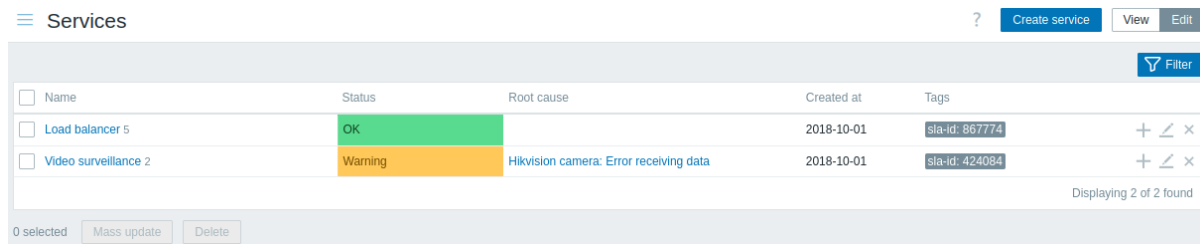

The screenshot shows the 'Services' management interface. At the top, there is a 'Services' header with a menu icon, a help icon, and buttons for 'Create service', 'View', and 'Edit'. Below the header is a table with columns for Name, Status, Root cause, Created at, and Tags. Two services are listed: 'Load balancer 5' with status 'OK' and 'Video surveillance 2' with status 'Warning'. The 'Video surveillance 2' service has a root cause of 'Hikvision camera: Error receiving data'. At the bottom, there are buttons for '0 selected', 'Mass update', and 'Delete', and a 'Filter' button in the top right corner of the table area.

Name	Status	Root cause	Created at	Tags
<input type="checkbox"/> Load balancer 5	OK		2018-10-01	sla-id: 867774
<input type="checkbox"/> Video surveillance 2	Warning	Hikvision camera: Error receiving data	2018-10-01	sla-id: 424084

To **configure** a new service, click on the *Create service* button in the top right-hand corner.

To quickly add a child service, you can alternatively press a plus icon next to the parent service. This will open the same service configuration form, but the *Parent services* parameter will be pre-filled.

Service configuration In the **Service** tab, specify required service parameters:

Service
? X

Service Tags 2 Child services

*** Name**

Parent services Select
type here to search

Name	Operation	Value	Action
<input style="width: 80%;" type="text" value="type"/>	<input type="button" value="Equals"/> ▾	<input style="width: 80%;" type="text" value="connection"/>	<input type="button" value="Remove"/>
Add			

*** Sort order (0->999)**

Status calculation rule i ▾

Description

Created at

[▼ Advanced configuration](#)

All mandatory input fields are marked with a red asterisk.

Parameter	Description
Name	Service name.
Parent services	Parent services the service belongs to. Leave this field empty if you are adding the service of highest level. One service may have multiple parent services. In this case, it will be displayed in the service tree under each of the parent services.
Problem tags	Specify tags to map problem data to the service: Equals - include the specified tag names and values (case-sensitive) Contains - include the specified tag names where the tag values contain the entered string (substring match, case-insensitive) Tag name matching is always case-sensitive.
Sort order	Sort order for display, lowest comes first.
Status calculation rule	Rule for calculating service status: Most critical if all children have problems - the most critical problem in the child services is used to color the service status, if all children have problems Most critical of child services - the most critical problem in the child services is used to color the service status Set status to OK - do not calculate service status Additional status calculation rules can be configured in the advanced configuration options.
Description	Service description.
Created at	The time when the service was created; displayed when editing an existing service.
Advanced configuration	Click on the <i>Advanced configuration</i> label to display advanced configuration options.

Advanced configuration

Advanced configuration

Additional rules	Name	Action
	Average - If at least 4 child services have Average status or above	Edit Remove
	Disaster - If at least 3 child services have High status or above	Edit Remove
	Add	

Status propagation rule:

* Weight:

[Add](#) [Cancel](#)

Parameter	Description
Additional rules	Click on <i>Add</i> to configure additional status calculation rules.
<i>Set status to</i>	Set service status to either <i>OK</i> (default), <i>Not classified</i> , <i>Information</i> , <i>Warning</i> , <i>Average</i> , <i>High</i> or <i>Disaster</i> in case of a condition match.
<i>Condition</i>	Select the condition for direct child services: if at least (N) child services have (Status) status or above if at least (N%) of child services have (Status) status or above if less than (N) child services have (Status) status or below if less than (N%) of child services have (Status) status or below if weight of child services with (Status) status or above is at least (W) if weight of child services with (Status) status or above is at least (N%) if weight of child services with (Status) status or below is less than (W) if weight of child services with (Status) status or below is less than (N%)
<i>N (W)</i>	If several conditions are specified and the situation matches more than one condition, the highest severity will be set.
<i>Status</i>	Set the value of N or W (1-100000), or N% (1-100) in the condition.
Status propagation rule	Select the value of <i>Status</i> in the condition: <i>OK</i> (default), <i>Not classified</i> , <i>Information</i> , <i>Warning</i> , <i>Average</i> , <i>High</i> or <i>Disaster</i> .
rule	Rule for propagating the service status to the parent service: As is - the status is propagated without change Increase by - you may increase the propagated status by 1 to 5 severities Decrease by - you may decrease the propagated status by 1 to 5 severities Ignore this service - the status is not propagated to the parent service at all Fixed status - the status is propagated statically, i.e. as always the same
Weight	Weight of the service (integer in the range from 0 (default) to 1000000).

Note:

Additional status calculation rules can only be used to increase severity level over the level calculated according to the main *Status calculation rule* parameter. If according to additional rules the status should be *Warning*, but according to the *Status calculation rule* the status is *Disaster* - the service will have status *Disaster*.

The **Tags** tab contains **service-level tags**. Service-level tags are used to identify a service. Tags of this type are not used to map problems to the service (for that, use *Problem tags* from the first tab).

The **Child services** tab allows to specify dependant services. Click on *Add* to add a service from the list of existing services. If you want to add a new child service, save this service first, then click on a plus icon next to the service that you have just created.

Tags There are two different types of tags in services:

- Service tags
- Problem tags

Service tags

Service tags are used to match services with **service actions** and **SLAs**. These tags are specified at the *Tags* service configuration tab. For mapping SLAs, *OR* logic is used: a service will be mapped to an SLA if it has at least one matching tag. In service actions, mapping rules are configurable and can use either *AND*, *OR*, or *AND/OR* logic.

Service	Tags 1	Child services 2
	Tags	
	Name	Value
	sla-id	424084

Problem tags

Problem tags are used to match problems and services. These tags are specified at the primary service configuration tab.

Only child services of the lowest hierarchy level may have problem tags defined and be directly correlated to problems. If problem tags match, the service status will change to the same status as the problem has. In case of several problems, a service will have the status of the most severe one. Status of a parent service is then calculated based on child services statuses according to Status calculation rules.

If several tags are specified, *AND* logic is used: a problem must have all tags specified in the service configuration to be mapped to the service.

Problem tags	Name	Operation	Value
	scope	Equals	availability
	target	Equals	mysql

Note:

A problem in Zabbix inherits tags from the whole chain of templates, hosts, items, web scenarios, and triggers. Any of these tags can be used for matching problems to services.

Example:

Problem *Web camera 3 is down* has tags `type:video-surveillance`, `floor:1` and `name:webcam-3` and status *Warning*

The service **Web camera 3** has the only problem tag specified: `name:webcam-3`

Problem tags	Name	Operation	Value
	name	Equals	webcam-3

Service status will change from *OK* to *Warning* when this problem is detected.

If the service **Web camera 3** had problem tags `name:webcam-3` and `floor:2`, its status would not be changed, when the problem is detected, because the conditions are only partially met.

Note:

The buttons described below are visible only when *Services* section is in the Edit mode.

Modifying existing services

To edit an existing service, press the pencil icon next to the service.

To clone an existing service, press the pencil icon to open its configuration and then press Clone button. When a service is cloned, its parent links are preserved, while the child links are not.

To delete a service, press on the x icon next to it. When you delete a parent service, its child services will not be deleted and will move one level higher in the service tree (1st level children will get the same level as the deleted parent service).

Two buttons below the list of services offer some mass-editing options:

- *Mass update* - mass update service properties
- *Delete* - delete the services

To use these options, mark the checkboxes before the respective services, then click on the required button.

2 SLA

Overview Once the *services* are created, you can start monitoring whether their performance is on track with service level agreement (SLA).

Services->SLA menu section allows to configure SLAs for various services. An SLA in Zabbix defines service level objective (SLO), expected uptime schedule and planned downtimes.

SLAs and services are matched by **service tags**. The same SLA may be applied to multiple services - performance will be measured for each matching service separately. A single service may have multiple SLAs assigned - data for each of the SLAs will be displayed separately.

In SLA reports Zabbix provides Service level indicator (SLI) data, which measures real service availability. Whether a service meets the SLA targets is determined by comparing SLO (expected availability in %) with SLI (real-life availability in %).

Configuration To create a new SLA, click on the *Create SLA* button.

The **SLA** tab allows to specify general SLA parameters.

Parameter	Description
<i>Name</i>	Enter the SLA name.
<i>SLO</i>	Enter the service level objective (SLO) as percentage.
<i>Reporting period</i>	Selecting the period will affect what periods are used in the SLA report - <i>daily, weekly, monthly, quarterly, or annually</i> .
<i>Time zone</i>	Select the SLA time zone.
<i>Schedule</i>	Select the SLA schedule - 24x7 or custom.
<i>Effective date</i>	Select the date of starting SLA calculation.
<i>Service tags</i>	Add service tags to identify the services towards which this SLA should be applied. Name - service tag name, must be exact match, case-sensitive. Operation - select <i>Equals</i> if the tag value must match exactly (case-sensitive) or <i>Contains</i> if part of the tag value must match (case-insensitive). Value - service tag value to search for according to selected operation.
<i>Description</i>	The SLA is applied to a service, if at least one service tag matches. Add a description for the SLA.
<i>Enabled</i>	Mark the checkbox to enable the SLA calculation.

The **Excluded downtimes** tab allows to specify downtimes that are excluded from the SLA calculation.

New SLA
? X

SLA
Excluded downtimes 1

Excluded downtimes	Start time	Duration	Name	Action
	2022-02-01 02:00	3h	Maintenance	Edit Remove
Add				

Add
Cancel

Click on *Add* to configure excluded downtimes, then enter the period name, start date and duration.

SLA reports How a service performs compared to an SLA is visible in the **SLA report**. SLA reports can be viewed:

- from the *SLA* section by clicking on the SLA report hyperlink;
- from the *Services* section by clicking on the SLA name in the info tab;
- in the Dashboard **widget SLA report**.

Once an SLA is configured, the *Info* tab in the services section will also display some information about service performance.

3 Setup example

Overview This section describes a simple setup for monitoring Zabbix high availability cluster as a service.

Pre-requisites Prior to configuring service monitoring, you need to have the hosts configured:

- *HA node 1* with at least one trigger and a tag (preferably set on a trigger level) component : `ha-node-1`
- *HA node 2* with at least one trigger and a tag (preferably set on a trigger level) component : `ha-node-2`

Service tree The next step is to build the service tree. In this example, the infrastructure is very basic and consists of three services: *Zabbix cluster* (parent) and two child services *Zabbix server node 1* and *Zabbix server node 2*.

```
Zabbix cluster
|
|- Zabbix server node 1
|- Zabbix server node 2
```

At the Services page, turn on *Edit* mode and press Create service:

Create service
View
Edit

In the service configuration window, enter name *Zabbix cluster* and click on the *Advanced configuration* label to display advanced configuration options.

New service
? X

Service
Tags
Child services

*** Name**

Parent services Select

Problem tags

Name	Operation	Value	Action
tag	Equals ▼	value	Remove
Add			

*** Sort order (0->999)**

Status calculation rule i Most critical of child services ▼

Description

Advanced configuration

Additional rules

Name	Action
Add	

Status propagation rule As is ▼

*** Weight**

Add
Cancel

Configure additional rule:

New additional rule
X

Set status to Disaster ▼

Condition If at least **N** child services have **Status** status or above ▼

N

Status Warning ▼

Add
Cancel

Zabbix cluster will have two child services - one for each of the HA nodes. If both HA nodes have problems of at least *Warning* status, parent service status should be set to *Disaster*. To achieve this, additional rule should be configured as:

- Set status to: Disaster
- Condition: If at least N child services have Status status or above
- N: 2
- Status: Warning

Switch to the *Tags* tab and add a tag `application:zabbix-server`. This tag will be used later for service actions and SLA reports.

Service **Tags 1** Child services

Tags	Name	Value
	application	zabbix-server

Save the new service.

To add a child service, press on the plus icon next to the Zabbix cluster service (the icon is visible only in *Edit* mode).

<input type="checkbox"/> Name	Status	Root cause	Created at	Tags	
<input type="checkbox"/> Zabbix cluster	OK		2024-10-01	application: zabbix-ser...	<input type="button" value="+"/> <input type="button" value="↵"/> <input type="button" value="✕"/>

Displaying 1 of 1 found

In the service configuration window, enter name *Zabbix server node 1*. Note that the Parent services parameter is already pre-filled with *Zabbix cluster*.

Availability of this service is affected by problems on the host *HA node 1*, marked with `component:HA node 1` problem tag. In the Problem tags parameter, enter:

- Name: component
- Operation: Equals
- Value: ha-node-1

New service ? ✕

Service **Tags 1** Child services

* Name

Parent services

Problem tags	Name	Operation	Value	Action
	component	Equals	ha-node-1	Remove

[Add](#)

* Sort order (0->999)

Status calculation rule

Description

Switch to the *Tags* tab and add a service tag: `zabbix-server:node-1`. This tag will be used later for service actions and SLA reports.

Service **Tags 1** Child services

Tags	Name	Value
	zabbix-server	node-1

Save the new service.

Create another child service of Zabbix cluster with name "Zabbix server node 2".

Set the Problem tags as:

- Name: component
- Operation: Equals
- Value: ha-node-2

Switch to the *Tags* tab and add a service tag: `zabbix-server:node-2`.

Save the new service.

SLA In this example, expected Zabbix cluster performance is 100% excluding semi-annual one hour maintenance period.

First, you need to add a new service level agreement.

Go to the *Services->SLA* menu section and press Create SLA. Enter name *Zabbix cluster performance* and set the SLO to 100%.

The service Zabbix cluster has a service tag `application:zabbix-server`. To use this SLA for measuring performance of Zabbix cluster, in the *Service tags* parameter, specify:

- Name: application
- Operation: Equals
- Value: zabbix-server

New SLA ? X

SLA Excluded downtimes

* Name

* SLO %

Reporting period Daily Weekly Monthly Quarterly Annually

Time zone ▼

Schedule 24x7 Custom

* Effective date

* Service tags

Name	Operation	Value	Action
<input type="text" value="application"/>	<input type="text" value="Equals"/> ▼	<input type="text" value="zabbix-server"/>	Remove

[Add](#)

Description

Enabled

In a real-life setup, you can also update desired reporting period, time zone and start date or change the schedule from 24/7 to custom. For this example, the default settings are sufficient.

Switch to the *Excluded downtimes* tab and add downtimes for scheduled maintenance periods to exclude these periods from SLA calculation. In the *Excluded downtimes* section press the *Add* link, enter downtime name, planned start time and duration.

New SLA ? X

SLA Excluded downtimes 2

Excluded downtimes	Start time	Duration	Name	Action
	2025-01-06 08:00 AM	1h	Maintenance Jan	Edit Remove
	2025-07-07 08:00 AM	1h	Maintenance Jul	Edit Remove
Add				

Add
Cancel

Press Add to save the new SLA.

Switch to the SLA reports section to view the SLA report for Zabbix cluster.

SLA report ?

SLA: Zabbix cluster performance x Select From: YYYY-MM-DD 📅

Service: Zabbix cluster x Select To: YYYY-MM-DD 📅

Apply Reset

Week	SLO	SLI	Uptime	Downtime	Error budget	Excluded downtimes
2024-09-29 - 10-05	100%	100	35m 2s	0	0	

The SLA info can also be checked in the *Services* section.

Services ? View Edit 🔄

All services / Zabbix cluster Info Filter

Zabbix cluster

Parent services:

Status: OK

SLA: Zabbix cluster performance: 100 📄

Tags: application: zabbix-ser...

Name	Status	Root cause	Created at	Tags
Zabbix server node 1	OK		2024-10-01	zabbix-server: node-1
Zabbix server node 2	OK		2024-10-01	zabbix-server: node-2

Displaying 2 of 2 found

9 Web monitoring

Overview With Zabbix you can check several availability aspects of web sites.

Attention:

To perform web monitoring Zabbix server must be initially **configured** with cURL (libcurl) support.

To activate web monitoring you need to define web scenarios. A web scenario consists of one or several HTTP requests or "steps". The steps are periodically executed by Zabbix server in a pre-defined order. If a host is monitored by proxy, the steps are executed by the proxy.

Web scenarios are attached to hosts/templates in the same way as items, triggers, etc. That means that web scenarios can also be created on a template level and then applied to multiple hosts in one move.

The following information is collected in any web scenario:

- average download speed per second for all steps of whole scenario
- number of the step that failed
- last error message

The following information is collected in any web scenario step:

- download speed per second
- response time

- response code

For more details, see [web monitoring items](#).

Data collected from executing web scenarios is kept in the database. The data is automatically used for graphs, triggers and notifications.

Zabbix can also check if a retrieved HTML page contains a pre-defined string. It can execute a simulated login and follow a path of simulated mouse clicks on the page.

Zabbix web monitoring supports both HTTP and HTTPS. When running a web scenario, Zabbix will optionally follow redirects (see option *Follow redirects* below). Maximum number of redirects is hard-coded to 10 (using cURL option [CURLOPT_MAXREDIRS](#)). All cookies are preserved during the execution of a single scenario.

Configuring a web scenario To configure a web scenario:

- Go to: *Data collection* → *Hosts* (or *Templates*)
- Click on *Web* in the row of the host/template
- Click on *Create web scenario* to the right (or on the scenario name to edit an existing scenario)
- Enter parameters of the scenario in the form

The **Scenario** tab allows you to configure the general parameters of a web scenario.

The screenshot shows the configuration form for a web scenario in Zabbix. The 'Scenario' tab is selected. The form contains the following fields and sections:

- Name:** Availability of example.com (marked with a red asterisk)
- Update interval:** 1m (marked with a red asterisk)
- Attempts:** 1 (marked with a red asterisk)
- Agent:** Zabbix (dropdown menu)
- HTTP proxy:** [protocol://][user[:password]@]proxy.example.com[:port]
- Variables:** A table with columns 'Name' and 'Value'. One entry is shown: Name: name, Value: value. There is an 'Add' link and a 'Remove' link for each entry.
- Headers:** A table with columns 'Name' and 'Value'. One entry is shown: Name: name, Value: value. There is an 'Add' link and a 'Remove' link for each entry.
- Enabled:** A checked checkbox.
- Buttons:** 'Add' and 'Cancel' buttons at the bottom.

All mandatory input fields are marked with a red asterisk.

Scenario parameters:

Parameter	Description
<i>Name</i>	<p>Unique scenario name.</p> <p>User macros are supported. <i>Note</i> that if user macros are used, these macros will be left unresolved in web monitoring item names.</p>
<i>Update interval</i>	<p>How often the scenario will be executed.</p> <p>Time suffixes are supported, e.g. 30s, 1m, 2h, 1d.</p> <p>User macros are supported. <i>Note</i> that if a user macro is used and its value is changed (e.g. 5m → 30s), the next check will be executed according to the previous value (farther in the future with the example values).</p> <p>New web scenarios will be checked within 60 seconds of their creation.</p>
<i>Attempts</i>	<p>The number of attempts for executing web scenario steps. In case of network problems (timeout, no connectivity, etc) Zabbix can repeat executing a step several times. The figure set will equally affect each step of the scenario. Up to 10 attempts can be specified, default value is 1.</p> <p><i>Note:</i> Zabbix will not repeat a step because of a wrong response code or the mismatch of a required string.</p>
<i>Agent</i>	<p>Select a client agent.</p> <p>Zabbix will pretend to be the selected browser. This is useful when a website returns different content for different browsers.</p>
<i>HTTP proxy</i>	<p>User macros can be used in this field.</p> <p>You can specify an HTTP proxy to use, using the format <code>[protocol://] [username[:password]@]proxy.example.com[:port]</code>. This sets the CURLOPT_PROXY cURL option.</p> <p>The optional <code>protocol://</code> prefix may be used to specify alternative proxy protocols (the protocol prefix support was added in cURL 7.21.7). With no protocol specified, the proxy will be treated as an HTTP proxy.</p> <p>By default, 1080 port will be used.</p> <p>If specified, the proxy will overwrite proxy related environment variables like <code>http_proxy</code>, <code>HTTPS_PROXY</code>. If not specified, the proxy will not overwrite proxy-related environment variables. The entered value is passed on "as is", no sanity checking takes place.</p> <p>You may also enter a SOCKS proxy address. If you specify the wrong protocol, the connection will fail and the item will become unsupported.</p> <p><i>Note</i> that only simple authentication is supported with HTTP proxy.</p> <p>User macros can be used in this field.</p>
<i>Variables</i>	<p>Variables that may be used in scenario steps (URL, post variables). They have the following format:</p> <pre> {macro1}=value1 {macro2}=value2 {macro3}=regex:<regular expression> {macro4}=jsonpath:<jsonpath> {macro5}=xmlxpath:<xmlxpath> {macro6}={{macro}.function()} (see macro functions) </pre> <p>For example:</p> <pre> {username}=Alexei {password}=kj3h5kj34bd {hostid}=regex:hostid is ([0-9]+) {url}=jsonpath:\$.host_url {status}=xmlxpath://host/response/status {newvar}={{myvar}.btoa()} </pre> <p>The macros can then be referenced in the steps as <code>{username}</code>, <code>{password}</code>, <code>{hostid}</code>, etc. Zabbix will automatically replace them with actual values. <i>Note</i> that variables with <code>regex:</code> need one step to get the value of the regular expression so the extracted value can only be applied to the step after.</p> <p>If the value part starts with <code>regex:</code> then the part after it is treated as a regular expression that searches the web page and, if found, stores the match in the variable. At least one subgroup must be present so that the matched value can be extracted.</p> <p>User macros and <code>{HOST.*}</code> macros are supported.</p> <p>Variables are automatically URL-encoded when used in query fields or form data for post variables, but must be URL-encoded manually when used in raw post or directly in URL.</p>

Parameter	Description
<i>Headers</i>	<p>HTTP Headers are used when performing a request. Default and custom headers can be used. Headers will be assigned using default settings depending on the Agent type selected from a drop-down list on a scenario level, and will be applied to all the steps, unless they are custom defined on a step level.</p> <p>It should be noted that defining the header on a step level automatically discards all the previously defined headers, except for a default header that is assigned by selecting the 'User-Agent' from a drop-down list on a scenario level.</p> <p>However, even the 'User-Agent' default header can be overridden by specifying it on a step level. To unset the header on a scenario level, the header should be named and attributed with no value on a step level.</p> <p>Headers should be listed using the same syntax as they would appear in the HTTP protocol, optionally using some additional features supported by the CURLOPT_HTTPHEADER cURL option.</p> <p>For example: Accept-Charset=utf-8 Accept-Language=en-US Content-Type=application/xml; charset=utf-8 User macros and {HOST.*} macros are supported.</p>
<i>Enabled</i>	The scenario is active if this box is checked, otherwise - disabled.

Note that when editing an existing scenario, two extra buttons are available in the form:

Clone	Create another scenario based on the properties of the existing one.
Clear history and trends	Delete history and trend data for the scenario. This will make the server perform the scenario immediately after deleting the data.

Note:
If *HTTP proxy* field is left empty, another way for using an HTTP proxy is to set proxy related environment variables. For HTTP checks - set the **http_proxy** environment variable for the Zabbix server user. For example, `http_proxy=http://proxy_ip:proxy_port`. For HTTPS checks - set the **HTTPS_PROXY** environment variable. For example, `HTTPS_PROXY=http://proxy_ip:proxy_port`. More details are available by running a shell command: `# man curl`.

The **Steps** tab allows you to configure the web scenario steps. To add a web scenario step, click on *Add* in the *Steps* block.

Scenario **Steps 2** Tags Authentication

* Steps

	Name	Timeout	URL	Required	Stat
⋮	1: Site availability	15s	http://www.example.com		200
⋮	2: About	15s	http://www.example.com/about		200
Add					

Note:
Secret **user macros** must not be used in URLs as they will resolve to "*****".

Step of web scenario ✕

*** Name**

*** URL**

Query fields

Name	Value	
<input type="text" value="name"/>	⇒ <input type="text" value="value"/>	Remove
Add		

Post type Form data Raw data

Post fields

Name	Value	
<input type="text" value="name"/>	⇒ <input type="text" value="value"/>	Remove
Add		

Variables

Name	Value	
<input type="text" value="name"/>	⇒ <input type="text" value="value"/>	Remove
Add		

Headers

Name	Value	
<input type="text" value="name"/>	⇒ <input type="text" value="value"/>	Remove
Add		

Follow redirects

Retrieve mode Body Headers Body and headers

*** Timeout**

Required string

Required status codes

Configuring steps

Step parameters:

Parameter	Description
<i>Name</i>	Unique step name. <i>User macros</i> are supported. Note that if user macros are used, these macros will be left unresolved in web monitoring item names.

Parameter	Description
<i>URL</i>	<p>URL to connect to and retrieve data. For example: https://www.example.com http://www.example.com/download</p> <p>Domain names can be specified in Unicode characters. They are automatically punycode-converted to ASCII when executing the web scenario step.</p> <p>The <i>Parse</i> button can be used to separate optional query fields (like <code>?name=Admin&password=mypassword</code>) from the URL, moving the attributes and values into <i>Query fields</i> for automatic URL-encoding.</p> <p>Variables can be used in the URL, using the <code>{macro}</code> syntax. Variables can be URL-encoded manually using a <code>{{macro}}.urlencode()</code> syntax.</p> <p>User macros and <code>{HOST.*}</code> macros are supported.</p> <p>Limited to 2048 characters.</p>
<i>Query fields</i>	<p>HTTP GET variables for the URL.</p> <p>Specified as attribute and value pairs.</p> <p>Values are URL-encoded automatically. Values from scenario variables, user macros or <code>{HOST.*}</code> macros are resolved and then URL-encoded automatically. Using a <code>{{macro}}.urlencode()</code> syntax will double URL-encode them.</p> <p>User macros and <code>{HOST.*}</code> macros are supported.</p>
<i>Post</i>	<p>HTTP POST variables.</p> <p>In Form data mode, specified as attribute and value pairs.</p> <p>Values are URL-encoded automatically. Values from scenario variables, user macros or <code>{HOST.*}</code> macros are resolved and then URL-encoded automatically.</p> <p>In Raw data mode, attributes/values are displayed on a single line and concatenated with a & symbol.</p> <p>Raw values can be URL-encoded/decoded manually using a <code>{{macro}}.urlencode()</code> or <code>{{macro}}.urldecode()</code> syntax.</p> <p>For example: <code>id=2345&userid={user}</code></p> <p>If <code>{user}</code> is defined as a variable of the web scenario, it will be replaced by its value when the step is executed. If you wish to URL-encode the variable, substitute <code>{user}</code> with <code>{{user}}.urlencode()</code>.</p> <p>User macros and <code>{HOST.*}</code> macros are supported.</p>
<i>Variables</i>	<p>Step-level variables that may be used for GET and POST functions.</p> <p>Specified as attribute and value pairs.</p> <p>Step-level variables override scenario-level variables or variables from the previous step.</p> <p>However, the value of a step-level variable only affects the step after (and not the current step).</p> <p>They have the following format:</p> <p>{macro}=value {macro}=regex:<regular expression></p> <p>For more information see variable description on the scenario level.</p> <p>Variables are automatically URL-encoded when used in query fields or form data for post variables, but must be URL-encoded manually when used in raw post or directly in URL.</p>
<i>Headers</i>	<p>Custom HTTP headers that will be sent when performing a request.</p> <p>Specified as attribute and value pairs.</p> <p>A header defined on a step level will be used for that particular step.</p> <p>It should be noted that defining the header on a step level automatically discards all the previously defined headers, except for a default header that is assigned by selecting the 'User-Agent' from a drop-down list on a scenario level.</p> <p>However, even the 'User-Agent' default header can be overridden by specifying it on a step level.</p> <p>For example, assigning the name to a header, but setting no value will unset the default header on a scenario level.</p> <p>User macros and <code>{HOST.*}</code> macros are supported.</p> <p>This sets the <code>CURLOPT_HTTPHEADER</code> cURL option.</p>
<i>Follow redirects</i>	<p>Mark the checkbox to follow HTTP redirects.</p> <p>This sets the <code>CURLOPT_FOLLOWLOCATION</code> cURL option.</p>
<i>Retrieve mode</i>	<p>Select the retrieve mode:</p> <p>Body - retrieve only body from the HTTP response Headers - retrieve only headers from the HTTP response Body and headers - retrieve body and headers from the HTTP response</p>

Parameter	Description
<i>Timeout</i>	Zabbix will not spend more than the set amount of time on processing the URL (from one second to maximum of 1 hour). Actually this parameter defines the maximum time for making connection to the URL and maximum time for performing an HTTP request. Therefore, Zabbix will not spend more than 2 x Timeout seconds on the step. Time suffixes are supported, e.g. 30s, 1m, 1h. User macros are supported.
<i>Required string</i>	Required regular expression pattern. Unless retrieved content (HTML) matches the required pattern the step will fail. If empty, no check on required string is performed. For example: Homepage of Zabbix Welcome.*admin <i>Note:</i> Referencing regular expressions created in the Zabbix frontend is not supported in this field. User macros and {HOST.*} macros are supported.
<i>Required status codes</i>	List of expected HTTP status codes. If Zabbix gets a code which is not in the list, the step will fail. If empty, no check on status codes is performed. For example: 200,201,210-299 User macros are supported.

Note:

Any changes in web scenario steps will only be saved when the whole scenario is saved.

See also a [real-life example](#) of how web monitoring steps can be configured.

Configuring tags The **Tags** tab allows to define scenario-level **tags**.

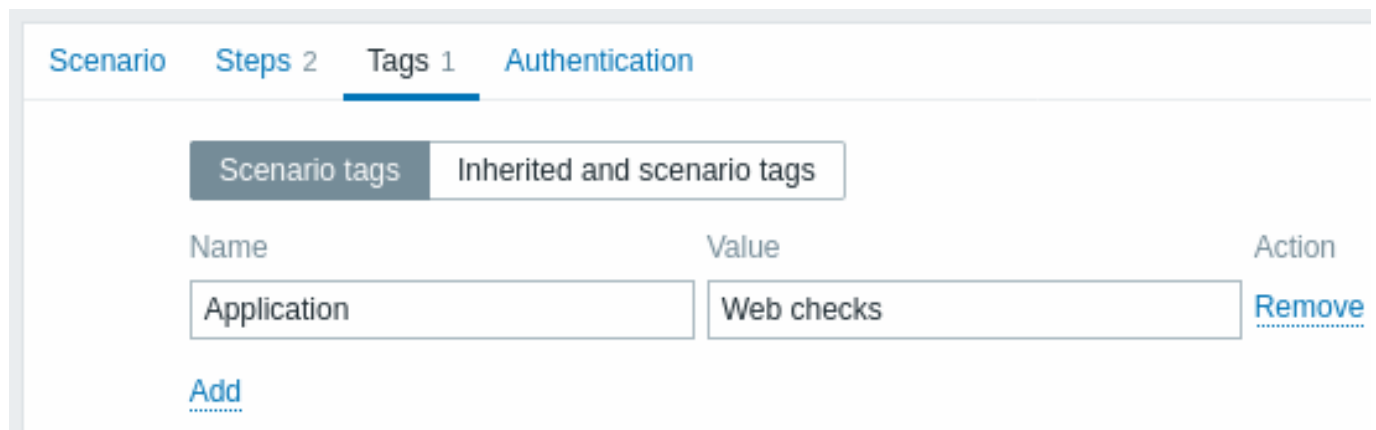

Tagging allows to filter web scenarios and web monitoring **items**.

Configuring authentication The **Authentication** tab allows you to configure scenario authentication options. A green dot next to the tab name indicates that some type of HTTP authentication is enabled.

HTTP authentication

SSL verify peer

SSL verify host

SSL certificate file

SSL key file

SSL key password

Authentication parameters:

Parameter	Description
<i>HTTP authentication</i>	Select the authentication option: None - no authentication used; Basic - basic authentication is used; NTLM - NTLM (Windows NT LAN Manager) authentication is used; Kerberos - Kerberos authentication is used (see also: Configuring Kerberos with Zabbix); Digest - Digest authentication is used.
<i>User</i>	Enter the user name (up to 255 characters). This field is available if <i>HTTP authentication</i> is set to Basic, NTLM, Kerberos, or Digest. User macros are supported.
<i>Password</i>	Enter the user password (up to 255 characters). This field is available if <i>HTTP authentication</i> is set to Basic, NTLM, Kerberos, or Digest. User macros are supported.
<i>SSL verify peer</i>	Mark the checkbox to verify the SSL certificate of the web server. The server certificate will be automatically taken from system-wide certificate authority (CA) location. You can override the location of CA files using Zabbix server or proxy configuration parameter SSLCALocation .
<i>SSL verify host</i>	This sets the CURLOPT_SSL_VERIFYPEER cURL option. Mark the checkbox to verify that the <i>Common Name</i> field or the <i>Subject Alternate Name</i> field of the web server certificate matches.
<i>SSL certificate file</i>	This sets the CURLOPT_SSL_VERIFYHOST cURL option. Name of the SSL certificate file used for client authentication. The certificate file must be in PEM ¹ format. If the certificate file contains also the private key, leave the <i>SSL key file</i> field empty. If the key is encrypted, specify the password in <i>SSL key password</i> field. The directory containing this file is specified by Zabbix server or proxy configuration parameter SSLCertLocation . HOST.* macros and user macros can be used in this field.
<i>SSL key file</i>	This sets the CURLOPT_SSLCERT cURL option. Name of the SSL private key file used for client authentication. The private key file must be in PEM ¹ format. The directory containing this file is specified by Zabbix server or proxy configuration parameter SSLKeyLocation . HOST.* macros and user macros can be used in this field.
<i>SSL key password</i>	This sets the CURLOPT_SSLKEY cURL option. SSL private key file password. User macros can be used in this field. This sets the CURLOPT_KEYPASSWD cURL option.

Attention:

[1] Zabbix supports certificate and private key files in PEM format only. In case you have your certificate and private key data in PKCS #12 format file (usually with extension *.p12 or *.pfx) you may generate the PEM file from it using the following commands:

```
openssl pkcs12 -in ssl-cert.p12 -clcerts -nokeys -out ssl-cert.pem
openssl pkcs12 -in ssl-cert.p12 -nocerts -nodes -out ssl-cert.key
```

Note:

Zabbix server picks up changes in certificates without a restart.

Note:

If you have client certificate and private key in a single file just specify it in a "SSL certificate file" field and leave "SSL key file" field empty. The certificate and key must still be in PEM format. Combining certificate and key is easy:

```
cat client.crt client.key > client.pem
```

Display To view web scenarios configured for a host, go to *Monitoring* → *Hosts*, locate the host in the list and click on the *Web* hyperlink in the last column. Click on the scenario name to get detailed information.

☰ Details of web scenario: Frontend check



Step	Speed	Response time	Response code	Status
First page	31.18 KBps	64.81ms	200	OK
Log in	44.64 KBps	258.36ms	200	OK
Log in Check	74.16 KBps	155.53ms	200	OK
Log out	19.03 KBps	106.17ms	200	OK
Log out check	42.13 KBps	47.96ms	200	OK
TOTAL		632.82ms		OK

◀ Zoom out ▶ Last 30 minutes

From

To

- Last 2 days
- Last 7 days
- Last 30 days
- Last 3 months
- Last 6 months
- Last 1 year
- Last 2 years
- Yesterday
- Day before yesterday
- This day last week
- Previous week
- Previous month
- Previous year
- Today
- Today so far
- This week
- This week so far
- This month
- This month so far
- This year
- This year so far
- Last 5 minutes
- Last 15 minutes
- Last 30 minutes**
- Last 1 hour
- Last 3 hours
- Last 6 hours
- Last 12 hours
- Last 1 day

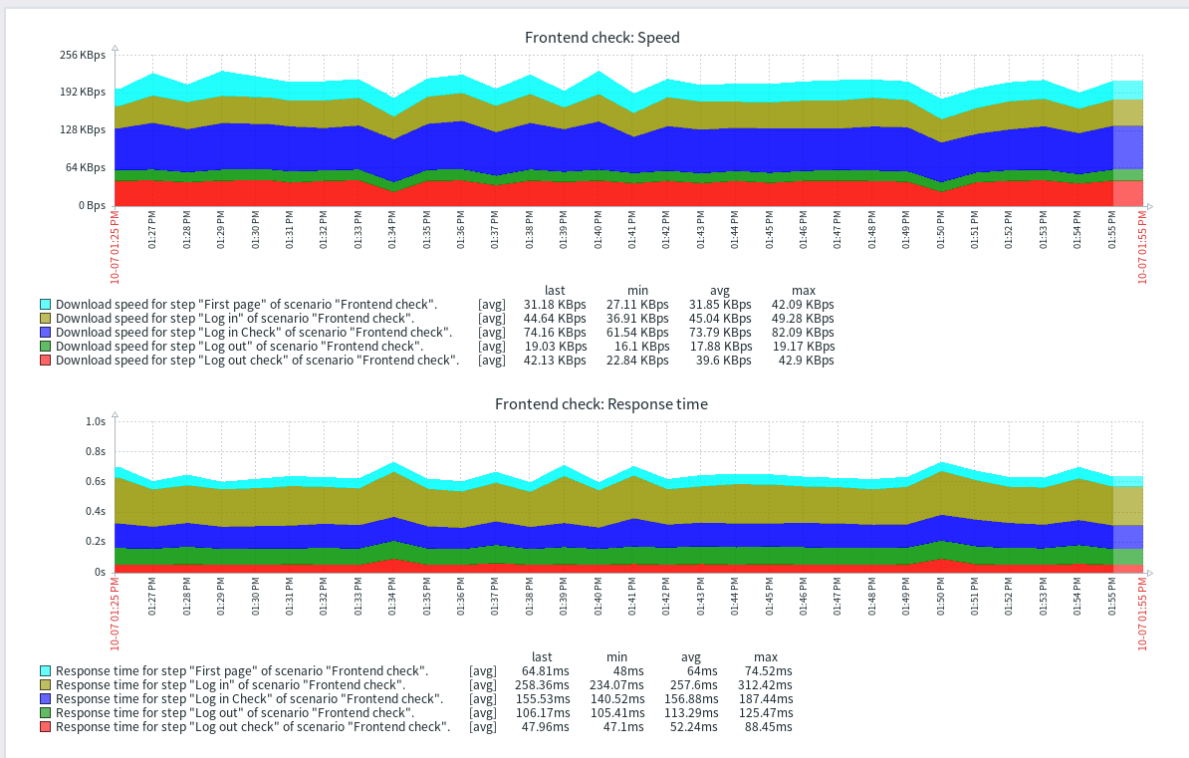

An overview of web scenarios can also be displayed in *Dashboards* by the Web monitoring widget.

Recent results of the web scenario execution are available in the *Monitoring* → *Latest data* section.

Extended monitoring Sometimes it is necessary to log received HTML page content. This is especially useful if some web scenario step fails. Debug level 5 (trace) serves that purpose. This level can be set in **server** and **proxy** configuration files or using a runtime control option (`-R log_level_increase="http poller,N"`, where N is the process number). The following examples demonstrate how extended monitoring can be started provided debug level 4 is already set:

```
# Increase log level of all http pollers:  
zabbix_server -R log_level_increase="http poller"
```

```
# Increase log level of second http poller:  
zabbix_server -R log_level_increase="http poller,2"
```

If extended web monitoring is not required it can be stopped using the `-R log_level_decrease` option.

1 Web monitoring items

Overview

Some new items are automatically added for monitoring when web scenarios are created.

All items inherit tags from the web scenario.

Scenario items

As soon as a scenario is created, Zabbix automatically adds the following items for monitoring.

Item	Description
<i>Download speed for scenario</i> <Scenario>	This item will collect information about the download speed (bytes per second) of the whole scenario, i.e. average for all steps. Item key: <code>web.test.in[Scenario,,bps]</code> Type: <i>Numeric(float)</i>
<i>Failed step of scenario</i> <Scenario>	This item will display the number of the step that failed on the scenario. If all steps are executed successfully, 0 is returned. Item key: <code>web.test.fail[Scenario]</code> Type: <i>Numeric(unsigned)</i>
<i>Last error message of scenario</i> <Scenario>	This item returns the last error message text of the scenario. A new value is stored only if the scenario has a failed step. If all steps are ok, no new value is collected. Item key: <code>web.test.error[Scenario]</code> Type: <i>Character</i>

The actual scenario name will be used instead of "Scenario".

Note:

If the scenario name contains **user macros**, these macros will be left unresolved in web monitoring item names.

 If the scenario name starts with a doublequote or contains a comma or a square bracket, it will be properly quoted in item keys. In other cases no additional quoting will be performed.

Note:

Web monitoring items are added with a 30 day history and a 90 day trend retention period.

These items can be used to create triggers and define notification conditions.

Example 1

To create a "Web scenario failed" trigger, you can define a trigger expression:

```
last(/host/web.test.fail[Scenario])<>0
```

Make sure to replace 'Scenario' with the real name of your scenario.

Example 2

To create a "Web scenario failed" trigger with a useful problem description in the trigger name, you can define a trigger with name:

```
Web scenario "Scenario" failed: {ITEM.VALUE}
```

and trigger expression:

```
length(last(/host/web.test.error[Scenario]))>0 and last(/host/web.test.fail[Scenario])>0
```

Make sure to replace 'Scenario' with the real name of your scenario.

Example 3

To create a "Web application is slow" trigger, you can define a trigger expression:

```
last(/host/web.test.in[Scenario,,bps])<10000
```

Make sure to replace 'Scenario' with the real name of your scenario.

Scenario step items

As soon as a step is created, Zabbix automatically adds the following items for monitoring.

Item	Description
<i>Download speed for step <Step> of scenario <Scenario></i>	This item will collect information about the download speed (bytes per second) of the step. Item key: web.test.in[Scenario,Step,bps] Type: <i>Numeric(float)</i>
<i>Response time for step <Step> of scenario <Scenario></i>	This item will collect information about the response time of the step in seconds. Response time is counted from the beginning of the request until all information has been transferred. Item key: web.test.time[Scenario,Step,resp] Type: <i>Numeric(float)</i>
<i>Response code for step <Step> of scenario <Scenario></i>	This item will collect response codes of the step. Item key: web.test.rspcode[Scenario,Step] Type: <i>Numeric(unsigned)</i>

Actual scenario and step names will be used instead of "Scenario" and "Step" respectively.

Note:

Web monitoring items are added with a 30 day history and a 90 day trend retention period.

Note:

If scenario name starts with a doublequote or contains comma or square bracket, it will be properly quoted in item keys. In other cases no additional quoting will be performed.

These items can be used to create triggers and define notification conditions. For example, to create a "Zabbix GUI login is too slow" trigger, you can define a trigger expression:

```
last(/zabbix/web.test.time[ZABBIX GUI,Login,resp])>3
```

2 Real-life scenario

Overview

This section presents a step-by-step real-life example of how web monitoring can be used.

Zabbix web monitoring will be used to monitor Zabbix frontend. The goal is to determine if it is available, provides the right content, and how quickly it works. To achieve this, several steps are required, including checking the availability of the first page, logging in with a username and password, verifying the login success, logging out, and confirming the logout.

Scenario

Add a new web scenario

Go to *Data collection* → *Hosts*, pick a host and click on *Web* in the row of that host. Then click on *Create web scenario*.

Scenario **Steps** Tags Authentication

* Name

* Update interval

* Attempts

Agent

HTTP proxy

Variables

Name	Value
<input style="width: 100px;" type="text" value="{password}"/>	<input style="width: 100px;" type="text" value="zabbix"/>
<input style="width: 100px;" type="text" value="{user}"/>	<input style="width: 100px;" type="text" value="zbx_monitor"/>

[Add](#)

Headers

Name	Value
<input style="width: 100px;" type="text" value="name"/>	<input style="width: 100px;" type="text" value="value"/>

[Add](#)

Enabled

In the new scenario form, fill out the following fields:

- **Name** - Frontend check
- **Update interval** - 1m
- **Attempts** - 1
- **Agent** - Zabbix

In the *Variables* section, add two variables: `{password}` and `{user}`. Enter your existing Zabbix user credentials as values. For safety reasons, it is recommended to create a separate user with minimal permissions to use for monitoring purposes. Optionally, switch to the *Tags* tab and add web scenario tags.

Note:

Once fully configured, this web scenario will automatically add a Zabbix trapper item to the host. You can use web scenario tags to quickly identify related items and triggers or search through collected data. For example, suitable tags for this tutorial are `component: web-scenario` and/or `target: frontend`.

Configure web scenario steps

Switch to the *Steps* tab and define steps for the scenario. Click on *Add* button to add an individual step.

Common fields

For each step described below, fill out the following fields in addition to the step-specific fields:

- **URL** - the URL of Zabbix frontend
- **Timeout** - 15s
- **Required status codes** - 200

Web scenario step 1

Check that the first page responds correctly, returns HTTP response code 200 and contains the text "Zabbix SIA".

- In the **Name** field, enter *First page*.
- In the **Required string** field, enter *Zabbix SIA*.
- Fill out the **common fields**.

When done configuring the step, press the *Add* button.

New step of web scenario

* Name

* URL

Query fields

Name	Value	
<input type="text" value="name"/>	⇒	<input type="text" value="value"/> Remove

[Add](#)

Post type Form data Raw data

Post fields

Name	Value	
<input type="text" value="name"/>	⇒	<input type="text" value="value"/> Remove

[Add](#)

Variables

Name	Value	
<input type="text" value="name"/>	⇒	<input type="text" value="value"/> Remove

[Add](#)

Headers

Name	Value	
<input type="text" value="name"/>	⇒	<input type="text" value="value"/> Remove

[Add](#)

Follow redirects

Retrieve mode Body Headers Body and headers

* Timeout

Required string

Required status codes

Web scenario step 2

Log in to the Zabbix frontend using the macros (variables) defined at the scenario level - *{user}* and *{password}*.

- In the **Name** field, enter *Login*.
- In the **Post fields** section, add three post fields:
 - *name* with value *{user}*
 - *password* with value *{password}*
 - *enter* with value *Sign in*
- In the **Variables** section, add a new variable *{csrf_token}* with value *regex:([0-9a-z]{64})*. This variable will catch the value of the assigned CSRF token to reuse in **step 4**.
- Fill out the **common fields**.

New step of web scenario ? X

* Name

* URL

Query fields

Name	Value
<input type="text" value="name"/>	<input type="text" value="value"/> Remove

[Add](#)

Post type Form data Raw data

Post fields

Name	Value
<input type="text" value="name"/>	<input type="text" value="{user}"/> Remove
<input type="text" value="password"/>	<input type="text" value="{password}"/> Remove
<input type="text" value="enter"/>	<input type="text" value="Sign in"/> Remove

[Add](#)

Variables

Name	Value
<input type="text" value="{csrf_token}"/>	<input type="text" value="regex:([0-9a-z]{64})"/> Remove

[Add](#)

Headers

Name	Value
<input type="text" value="name"/>	<input type="text" value="value"/> Remove

[Add](#)

Follow redirects

Retrieve mode Body Headers Body and headers

* Timeout

Required string

Required status codes

Attention:

Note that Zabbix frontend uses JavaScript redirect when logging in, so login must occur first, and logged-in features can be checked only in further steps. Additionally, the login step must use the full URL to **index.php** file.

Web scenario step 3

After logging in, verify success by checking for a string visible only when logged in - for example, *Administration*.

- In the **Name** field, enter *Login check*.
- In the **Required string** field, enter *Administration*.
- Fill out the **common fields**.

New step of web scenario ? X

* Name

* URL

Query fields

Name	⇒	Value	
<input type="text" value="name"/>	⇒	<input type="text" value="value"/>	Remove

[Add](#)

Post type Form data Raw data

Post fields

Name	⇒	Value	
<input type="text" value="name"/>	⇒	<input type="text" value="value"/>	Remove

[Add](#)

Variables

Name	⇒	Value	
<input type="text" value="name"/>	⇒	<input type="text" value="value"/>	Remove

[Add](#)

Headers

Name	⇒	Value	
<input type="text" value="name"/>	⇒	<input type="text" value="value"/>	Remove

[Add](#)

Follow redirects

Retrieve mode Body Headers Body and headers

* Timeout

Required string

Required status codes

Web scenario step 4

Once the frontend's accessibility and login have been verified, add a logout step - otherwise the Zabbix database will become cluttered with many open session records.

- In the **Name** field, enter *Logout*.
- In the **Post fields** section, add two post fields:
 - *reconnect* with value *1*
 - *_csrf_token* with value *{csrf_token}*.
- Fill out the **common fields**.

This step uses the variable `{csrf_token}` obtained in [step 2](#)

New step of web scenario ? X

* Name

* URL

Query fields

Name	Value	
<input type="text" value="name"/>	⇒ <input type="text" value="value"/>	Remove
Add		

Post type Form data Raw data

Post fields

Name	Value	
<input type="text" value="reconnect"/>	⇒ <input type="text" value="1"/>	Remove
<input type="text" value="_csrf_token"/>	⇒ <input type="text" value="{csrf_token}"/>	Remove
Add		

Variables

Name	Value	
<input type="text" value="name"/>	⇒ <input type="text" value="value"/>	Remove
Add		

Headers

Name	Value	
<input type="text" value="name"/>	⇒ <input type="text" value="value"/>	Remove
Add		

Follow redirects

Retrieve mode Body Headers Body and headers

* Timeout

Required string

Required status codes

Web scenario step 5

To confirm the logout, check for the **Username** string.

- In the **Name** field, enter *First page*.
- In the **Required string** field, enter *Username*.
- Fill out the **common fields**.

New step of web scenario ? X

*** Name**

*** URL**

Query fields

Name	Value
<input type="text" value="name"/>	<input type="text" value="value"/>

[Remove](#)

[Add](#)

Post type Form data Raw data

Post fields

Name	Value
<input type="text" value="name"/>	<input type="text" value="value"/>

[Remove](#)

[Add](#)

Variables

Name	Value
<input type="text" value="name"/>	<input type="text" value="value"/>

[Remove](#)

[Add](#)

Headers

Name	Value
<input type="text" value="name"/>	<input type="text" value="value"/>

[Remove](#)

[Add](#)

Follow redirects

Retrieve mode Body Headers Body and headers

*** Timeout**

Required string

Required status codes

Full configuration of steps

A complete configuration of web scenario steps should look like this:

#	Name	Timeout	URL	Required	Status codes	Action
1:	First page	15s	http://127.0.0.1/index.php	Zabbix SIA	200	Remove
2:	Log in	15s	http://127.0.0.1/index.php		200	Remove
3:	Log in Check	15s	http://127.0.0.1/index.php	Administrati...	200	Remove
4:	Log out	15s	http://127.0.0.1/index.php		200	Remove
5:	Log out check	15s	http://127.0.0.1/index.php	Username	200	Remove

[Add](#)

Check the results

Save the finished web monitoring scenario.

The scenario will be added to the host. To view web scenario information go to *Monitoring* → *Hosts*, locate the host in the list and click on the Web hyperlink in the last column.

Host	Name	Number of steps	Last check	Status	Tags
Zabbix frontend	Frontend check	5	17s	OK	component: web-scen...

Displaying 1 of 1 found

Click on the scenario name to see more detailed statistics:

Details of web scenario: Frontend check

Step	Speed	Response time	Response code	Status
First page	31.18 KBps	64.81ms	200	OK
Log in	44.64 KBps	258.36ms	200	OK
Log in Check	74.16 KBps	155.53ms	200	OK
Log out	19.03 KBps	106.17ms	200	OK
Log out check	42.13 KBps	47.96ms	200	OK
TOTAL		632.82ms		OK

Zoom out Last 30 minutes

From: To:

- Last 2 days
- Last 7 days
- Last 30 days
- Last 3 months
- Last 6 months
- Last 1 year
- Last 2 years
- Yesterday
- Day before yesterday
- This day last week
- Previous week
- Previous month
- Previous year
- Today
- Today so far
- This week
- This week so far
- This month
- This month so far
- This year
- This year so far
- Last 5 minutes
- Last 15 minutes
- Last 30 minutes
- Last 1 hour
- Last 3 hours
- Last 6 hours
- Last 12 hours
- Last 1 day

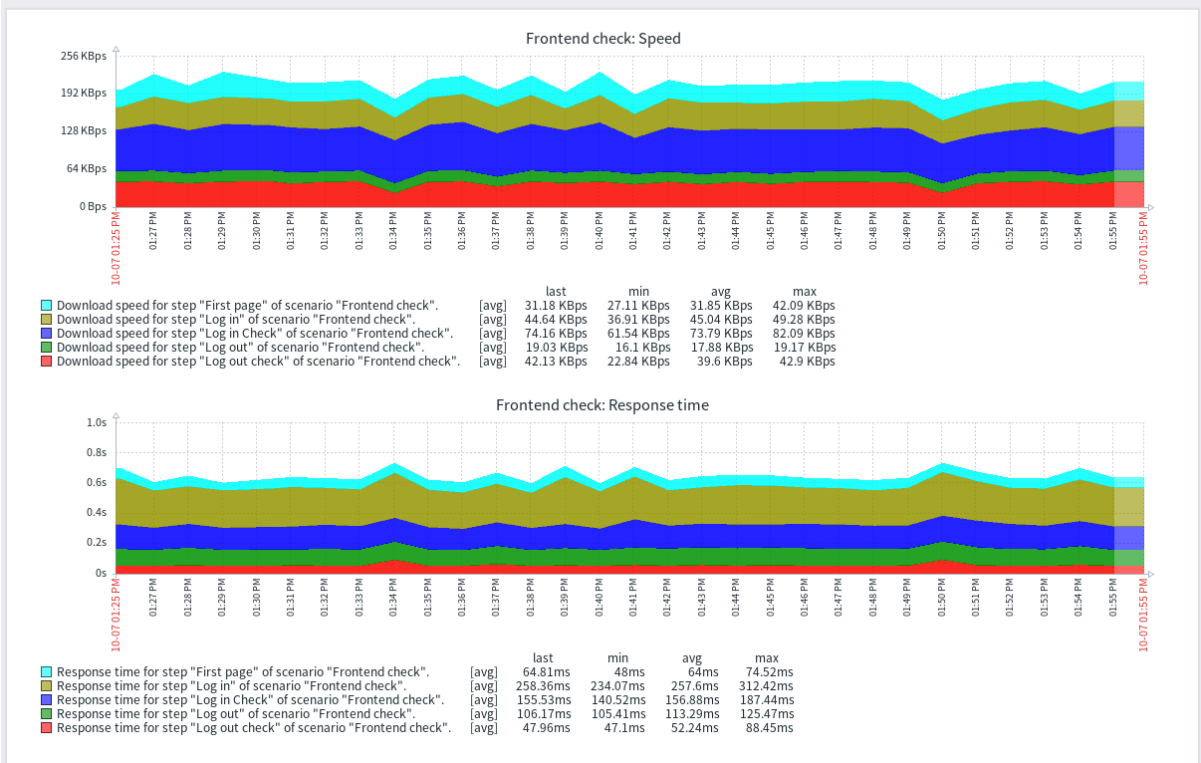

10 Virtual machine monitoring

Overview Zabbix can use **low-level discovery** rules to automatically discover VMware hypervisors and virtual machines, and create hosts to monitor them based on pre-defined **host prototypes**.

Zabbix also includes **ready-to-use templates** for monitoring VMware vCenter or ESXi hypervisors.

The minimum required VMware vCenter or vSphere version is 5.1.

Data collection Virtual machine monitoring consists of two steps:

1. Zabbix *vmware collector* processes collect virtual machine data - the processes obtain necessary information from VMware web services over the SOAP protocol, pre-process it, and store it in Zabbix server shared memory.
2. Zabbix *poller* processes retrieve data using Zabbix simple check [VMware monitoring item keys](#).

Zabbix divides collected data into VMware configuration data and VMware performance counter data. Both types of data are collected independently by the *vmware collector* processes.

The following statistics are available based on the VMware performance counter information:

- Datastore
- Disk device
- CPU
- Power
- Network interface
- Custom performance counter items

For the complete list of items that obtain data from VMware performance counters, see [VMware monitoring item keys](#).

Note that the frequency of VMware event retrieval depends on the polling interval of `vmware.eventlog`, but cannot be less than 5 seconds.

Configuration If Zabbix server is compiled from [sources](#), it must be compiled with the `--with-libcurl --with-libxml2` configuration options to enable virtual machine monitoring. Zabbix packages are compiled with these options already enabled.

The following Zabbix server configuration file parameters can be modified for virtual machine monitoring:

- `StartVMwareCollectors`

Note:

It is recommended to enable more collectors than the number of monitored VMware services; otherwise, the retrieval of VMware performance counter statistics might be delayed by the retrieval of VMware configuration data (which takes a while for large installations).
Generally, the value of `StartVMwareCollectors` should not dip below 2 and should not exceed twice the amount of monitored VMware services: $\text{Amount of services} < \text{StartVMwareCollectors} < (\text{Amount of services} * 2)$. For example, when monitoring one VMware service, set `StartVMwareCollectors` to 2; when monitoring three services, set `StartVMwareCollectors` to 5.
Note that the required number of collectors also depends on the scope of the VMware environment, and the `VMwareFrequency` and `VMwarePerfFrequency` configuration parameters.

- `VMwareCacheSize`
- `VMwareFrequency`
- `VMwarePerfFrequency`
- `VMwareTimeout`

Attention:

To support datastore capacity metrics, ensure that the value of the VMware `vpxd.stats.maxQueryMetrics` key is set to at least 64. For more information, see the [VMware Knowledge Base article](#).

Discovery

Zabbix can use low-level discovery rules (for example, `vmware.hv.discovery[{$VMWARE.URL}]`) to automatically discover VMware hypervisors and virtual machines. Moreover, Zabbix can use host prototypes to automatically generate real hosts for the discovered entities. For more information, see [Host prototypes](#).

Configuration examples

For a basic example of how to set up Zabbix for monitoring VMware using the *VMware FQDN* template, see [Monitor VMware with Zabbix](#).

For a more detailed example of how to create a host, a low-level discovery rule, and a host prototype for monitoring VMware, see [Setup example](#).

Extended logging The data collected by the *vmware collector* processes can be logged for detailed debugging using debug level 5. The debug level can be configured in the `server` and `proxy` configuration files or using the runtime control option `-R log_level_increase="vmware collector,N"`, where "N" is the process number.

For example, to increase the debug level from 4 to 5 for all *vmware collector* processes, run the following command:

```
zabbix_server -R log_level_increase="vmware collector"
```

To increase the debug level from 4 to 5 for the second *vmware collector* process, run the following command:

```
zabbix_server -R log_level_increase="vmware collector,2"
```

When extended logging of VMware collector data is no longer required, it is recommended to decrease the debug level to default (3) by running the `-R log_level_decrease` command.

Troubleshooting

- In case of unavailable metrics, please ensure that they are not made unavailable or turned off by default in recent VMware vSphere versions, or if some limits are not placed on performance-metric database queries. For more information, see [ZBX-12094](#).
- If `config.vpxd.stats.maxQueryMetrics` is invalid or exceeds the maximum number of characters permitted error, add a `config.vpxd.stats.maxQueryMetrics` parameter to the vCenter Server settings. The value of this parameter should be the same as the value of `maxQuerysize` in VMware's `web.xml` file. For more information, see [VMware Knowledge Base article](#).

1 VMware monitoring item keys

Overview This page provides details on the simple checks that can be used to monitor **VMware environments**. The metrics are grouped by the monitoring target.

Supported item keys The item keys are listed without parameters and additional information. Click on the item key to see the full details.

Item key	Description	Item group
vmware.eventlog	The VMware event log.	General service
vmware.fullname	The VMware service full name.	
vmware.version	The VMware service version.	
vmware.cl.perfcounter	The VMware cluster performance counter metrics.	Cluster
vmware.cluster.alarms.get	The VMware cluster alarms data.	
vmware.cluster.discovery	The discovery of VMware clusters.	
vmware.cluster.property	The VMware cluster property.	
vmware.cluster.status	The VMware cluster status.	
vmware.cluster.tags.get	The VMware cluster tags array.	
vmware.datastore.alarms.get	The VMware datastore alarms data.	Datastore
vmware.datastore.discovery	The discovery of VMware datastores.	
vmware.datastore.hv.list	The list of datastore hypervisors.	
vmware.datastore.perfcounter	The VMware datastore performance counter value.	
vmware.datastore.property	The VMware datastore property.	
vmware.datastore.read	The amount of time for a read operation from the datastore.	
vmware.datastore.size	The VMware datastore space in bytes or in percentage from total.	
vmware.datastore.tags.get	The VMware datastore tags array.	
vmware.datastore.write	The amount of time for a write operation to the datastore.	
vmware.dc.alarms.get	The VMware datacenter alarms data.	Datacenter
vmware.dc.discovery	The discovery of VMware datacenters.	
vmware.dc.tags.get	The VMware datacenter tags array.	
vmware.dvswitch.discovery	The discovery of VMware vSphere Distributed Switches.	vSphere Distributed Switch
vmware.dvswitch.fetchports	The VMware vSphere Distributed Switch ports data.	
vmware.hv.alarms.get	The VMware hypervisor alarms data.	Hypervisor
vmware.hv.cluster.name	The VMware hypervisor cluster name.	
vmware.hv.connectionstate	The VMware hypervisor connection state.	
vmware.hv.cpu.usage	The VMware hypervisor processor usage (Hz).	
vmware.hv.cpu.usage.perf	The VMware hypervisor processor usage as a percentage during the interval.	
vmware.hv.cpu.utilization	The VMware hypervisor processor usage as a percentage during the interval, depends on power management or HT.	
vmware.hv.datacenter.name	The VMware hypervisor datacenter name.	
vmware.hv.datastore.discovery	The discovery of VMware hypervisor datastores.	

Item key	Description	Item group
vmware.hv.datastore.list	The list of VMware hypervisor datastores.	
vmware.hv.datastore.multipath	The number of available datastore paths.	
vmware.hv.datastore.read	The average amount of time for a read operation from the datastore.	
vmware.hv.datastore.size	The VMware datastore space in bytes or in percentage from total.	
vmware.hv.datastore.write	The average amount of time for a write operation to the datastore.	
vmware.hv.discovery	The discovery of VMware hypervisors.	
vmware.hv.diskinfo.get	The VMware hypervisor disk data.	
vmware.hv.fullname	The VMware hypervisor name.	
vmware.hv.hw.cpu.freq	The VMware hypervisor processor frequency.	
vmware.hv.hw.cpu.model	The VMware hypervisor processor model.	
vmware.hv.hw.cpu.num	The number of processor cores on VMware hypervisor.	
vmware.hv.hw.cpu.threads	The number of processor threads on VMware hypervisor.	
vmware.hv.hw.memory	The VMware hypervisor total memory size.	
vmware.hv.hw.model	The VMware hypervisor model.	
vmware.hv.hw.sensors.get	The VMware hypervisor hardware sensors value.	
vmware.hv.hw.serialnumber	The VMware hypervisor serial number.	
vmware.hv.hw.uuid	The VMware hypervisor BIOS UUID.	
vmware.hv.hw.vendor	The VMware hypervisor vendor name.	
vmware.hv.maintenance	The VMware hypervisor maintenance status.	
vmware.hv.memory.size.balloon	The VMware hypervisor ballooned memory size.	
vmware.hv.memory.used	The VMware hypervisor used memory size.	
vmware.hv.net.if.discovery	The discovery of VMware hypervisor network interfaces.	
vmware.hv.network.in	The VMware hypervisor network input statistics.	
vmware.hv.network.linkspeed	The VMware hypervisor network interface speed.	
vmware.hv.network.out	The VMware hypervisor network output statistics.	
vmware.hv.perfcouter	The VMware hypervisor performance counter value.	
vmware.hv.property	The VMware hypervisor property.	
vmware.hv.power	The VMware hypervisor power usage.	
vmware.hv.sensor.health.state	The VMware hypervisor health state rollup sensor.	
vmware.hv.sensors.get	The VMware hypervisor HW vendor state sensors.	
vmware.hv.status	The VMware hypervisor status.	
vmware.hv.tags.get	The VMware hypervisor tags array.	
vmware.hv.uptime	The VMware hypervisor uptime.	
vmware.hv.version	The VMware hypervisor version.	
vmware.hv.vm.num	The number of virtual machines on the VMware hypervisor.	
vmware.rp.cpu.usage	The CPU usage in hertz during the interval on VMware Resource Pool.	Resource pool
vmware.rp.memory	The memory metrics of VMware resource pool.	
vmware.alarms.get	The VMware virtual center alarms data.	Virtual center
vmware.vm.alarms.get	The VMware virtual machine alarms data.	Virtual machine
vmware.vm.attribute	The VMware virtual machine custom attribute value.	
vmware.vm.cluster.name	The VMware virtual machine name.	
vmware.vm.consolidationneeded	The VMware virtual machine disk requires consolidation.	
vmware.vm.cpu.latency	The percentage of time the virtual machine is unable to run because it is contending for access to the physical CPU(s).	
vmware.vm.cpu.num	The number of processors on VMware virtual machine.	
vmware.vm.cpu.readiness	The percentage of time that the virtual machine was ready, but could not get scheduled to run on the physical CPU.	
vmware.vm.cpu.ready	The time that the virtual machine was ready, but could not get scheduled to run on the physical CPU.	
vmware.vm.cpu.swapwait	The percentage of CPU time spent waiting for swap-in.	
vmware.vm.cpu.usage	The VMware virtual machine processor usage (Hz).	
vmware.vm.cpu.usage.per	The VMware virtual machine processor usage as a percentage during the interval.	
vmware.vm.datacenter.name	The VMware virtual machine datacenter name.	
vmware.vm.discovery	The discovery of VMware virtual machines.	
vmware.vm.guest.memory.size.swap	The amount of guest physical memory that is swapped out to the swap space.	
vmware.vm.guest.osuptime	The total time elapsed since the last operating system boot-up.	
vmware.vm.hv.maintenance	The VMware virtual machine hypervisor maintenance status.	
vmware.vm.hv.name	The VMware virtual machine hypervisor name.	

Item key	Description	Item group
<code>vmware.vm.memory.size</code>	The VMware virtual machine total memory size.	
<code>vmware.vm.memory.size.ballooned</code>	The VMware virtual machine ballooned memory size.	
<code>vmware.vm.memory.size.compressed</code>	The VMware virtual machine compressed memory size.	
<code>vmware.vm.memory.size.uncached</code>	The amount of host physical memory consumed for backing up guest physical memory pages.	
<code>vmware.vm.memory.size.private</code>	The VMware virtual machine private memory size.	
<code>vmware.vm.memory.size.shared</code>	The VMware virtual machine shared memory size.	
<code>vmware.vm.memory.size.swapped</code>	The VMware virtual machine swapped memory size.	
<code>vmware.vm.memory.size.guest</code>	The VMware virtual machine guest memory usage.	
<code>vmware.vm.memory.size.host</code>	The VMware virtual machine host memory usage.	
<code>vmware.vm.memory.usage</code>	The percentage of host physical memory that has been consumed.	
<code>vmware.vm.net.if.discovery</code>	The discovery of VMware virtual machine network interfaces.	
<code>vmware.vm.net.if.in</code>	The VMware virtual machine network interface input statistics.	
<code>vmware.vm.net.if.out</code>	The VMware virtual machine network interface output statistics.	
<code>vmware.vm.net.if.usage</code>	The VMware virtual machine network utilization during the interval.	
<code>vmware.vm.perfcounter</code>	The VMware virtual machine performance counter value.	
<code>vmware.vm.powerstate</code>	The VMware virtual machine power state.	
<code>vmware.vm.property</code>	The VMware virtual machine property.	
<code>vmware.vm.snapshot.get</code>	The VMware virtual machine snapshot state.	
<code>vmware.vm.state</code>	The VMware virtual machine state.	
<code>vmware.vm.storage.committed</code>	The VMware virtual machine committed storage space.	
<code>vmware.vm.storage.reads</code>	The average number of outstanding read requests to the virtual disk during the collection interval.	
<code>vmware.vm.storage.readlatency</code>	The average time a read from the virtual disk takes.	
<code>vmware.vm.storage.write</code>	The average number of outstanding write requests to the virtual disk during the collection interval.	
<code>vmware.vm.storage.writelatency</code>	The average time a write to the virtual disk takes.	
<code>vmware.vm.storage.uncommitted</code>	The VMware virtual machine uncommitted storage space.	
<code>vmware.vm.storage.unshared</code>	The VMware virtual machine unshared storage space.	
<code>vmware.vm.storage.writes</code>	The average number of outstanding write requests to the virtual disk during the collection interval.	
<code>vmware.vm.tags.get</code>	The VMware virtual machine tags array.	
<code>vmware.vm.tools</code>	The VMware virtual machine guest tools state.	
<code>vmware.vm.uptime</code>	The VMware virtual machine uptime.	
<code>vmware.vm.vfs.dev.discovery</code>	The discovery of VMware virtual machine disk devices.	
<code>vmware.vm.vfs.dev.read</code>	The VMware virtual machine disk device read statistics.	
<code>vmware.vm.vfs.dev.write</code>	The VMware virtual machine disk device write statistics.	
<code>vmware.vm.vfs.fs.discovery</code>	The discovery of VMware virtual machine file systems.	
<code>vmware.vm.vfs.fs.size</code>	The VMware virtual machine file system statistics.	

Item key details Parameters without angle brackets are mandatory. Parameters marked with angle brackets < > are optional.

`vmware.eventlog[url,<mode>,<severity>]`

 The VMware event log.
 Return value: *Log*.

Parameters:

- **url** - the VMware service URL;
- **mode** - *all* (default) or *skip* - skip the processing of older data;
- **severity** - filter by severity: *error*, *warning*, *info* or *user*. This parameter must be quoted if more than one severity is specified in a comma-delimited list (e.g. "error ,warning ,info ,user"). Disabled by default.

Comments:

- There must be only one `vmware.eventlog` item key per URL;
- See also [example of filtering VMware event log records](#).

`vmware.fullnameurl`

 The VMware service full name.
 Return value: *String*.

Parameters:

- **url** - the VMware service URL.

`vmware.versionurl`

 The VMware service version.
 Return value: *String*.

Parameters:

- **url** - the VMware service URL.

`vmware.cl.perfcounter[url,id,path,<instance>]`

 The VMware cluster performance counter metrics.
 Return value: *Integer*.

Parameters:

- **url** - the VMware service URL;
- **id** - the VMware cluster ID. `id` can be received from `vmware.cluster.discovery []` as `{#CLUSTER.ID}`.
- **path** - the performance counter path¹;
- **instance** - the performance counter instance.

`vmware.cluster.alarms.get[url,id]`

 The VMware cluster alarms data.
 Return value: *JSON object*.

Parameters:

- **url** - the VMware service URL;
- **id** - the VMware cluster ID.

`vmware.cluster.discoveryurl`

 The discovery of VMware clusters.
 Return value: *JSON object*.

Parameters:

- **url** - the VMware service URL.

`vmware.cluster.property[url,id,prop]`

 The VMware cluster property.
 Return value: *String*.

Parameters:

- **url** - the VMware service URL;
- **id** - the VMware cluster ID;
- **prop** - the property path which is the name of a property of the VM object as defined in the [VMware SDK](#).

Examples:

```
vmware.vm.property[{$VMWARE.URL},{$VMWARE.VM.UUID},overallStatus]
vmware.vm.property[{$VMWARE.URL},{$VMWARE.VM.UUID},runtime.powerState]
```

`vmware.cluster.status[url,name]`

 The VMware cluster status.
 Return value: *0 - gray; 1 - green; 2 - yellow; 3 - red*.

Parameters:

- **url** - the VMware service URL;
- **name** - the VMware cluster name.

`vmware.cluster.tags.get[url,id]`

 The VMware cluster tags array.
 Return value: *JSON object*.

Parameters:

- **url** - the VMware service URL;
- **id** - the VMware cluster ID.

This item works with vSphere 6.5 and newer.

`vmware.datastore.alarms.get[url,uuid]`

 The VMware datastore alarms data.
 Return value: *JSON object*.

Parameters:

- **url** - the VMware service URL;
- **uuid** - the VMware datastore global unique identifier.

`vmware.datastore.discoveryurl`

 The discovery of VMware datastores.
 Return value: *JSON object*.

Parameters:

- **url** - the VMware service URL.

vmware.datastore.hv.list[url,datastore]

 The list of datastore hypervisors.
 Return value: *String*.

Parameters:

- **url** - the VMware service URL;
- **datastore** - the datastore name.

Output example:

esx7-01-host.zabbix.sandbox

esx7-02-host.zabbix.sandbox

vmware.datastore.perfcounter[url,uuid,path,<instance>]

 The VMware datastore performance counter value.
 Return value: *Integer*².

Parameters:

- **url** - the VMware service URL;
- **uuid** - the VMware datastore global unique identifier;
- **path** - the performance counter path¹;
- **instance** - the performance counter instance. Use empty instance for aggregate values (default).

vmware.datastore.property[url,uuid,prop]

 The VMware datastore property.
 Return value: *String*.

Parameters:

- **url** - the VMware service URL;
- **uuid** - the VMware datastore global unique identifier;
- **prop** - the property path.

vmware.datastore.read[url,datastore,<mode>]

 The amount of time for a read operation from the datastore (milliseconds).
 Return value: *Integer*².

Parameters:

- **url** - the VMware service URL;
- **datastore** - the datastore name;
- **mode** - *latency* (average value, default) or *maxlatency* (maximum value).

vmware.datastore.size[url,datastore,<mode>]

 The VMware datastore space in bytes or in percentage from total.
 Return value: *Integer* - for bytes; *Float* - for percentage.

Parameters:

- **url** - the VMware service URL;
- **datastore** - the datastore name;
- **mode** - possible values: *total* (default), *free*, *pfree* (free percentage), *uncommitted*.

vmware.datastore.tags.get[url,uuid]

 The VMware datastore tags array.
 Return value: **JSON object**.

Parameters:

- **url** - the VMware service URL;
- **uuid** - the VMware datastore global unique identifier.

This item works with vSphere 6.5 and newer.

vmware.datastore.write[url,datastore,<mode>]

 The amount of time for a write operation to the datastore (milliseconds).
 Return value: *Integer*².

Parameters:

- **url** - the VMware service URL;
- **datastore** - the datastore name;
- **mode** - *latency* (average value, default) or *maxlatency* (maximum value).

vmware.dc.alarms.get[url,id]

 The VMware datacenter alarms data.
 Return value: **JSON object**.

Parameters:

- **url** - the VMware service URL;
- **id** - the VMware datacenter ID.

vmware.dc.discoveryurl

 The discovery of VMware datacenters.
 Return value: **JSON object**.

Parameters:

- **url** - the VMware service URL.

vmware.dc.tags.get[url,id]

 The VMware datacenter tags array.
 Return value: **JSON object**.

Parameters:

- **url** - the VMware service URL;
- **id** - the VMware datacenter ID.

This item works with vSphere 6.5 and newer.

vmware.dvswitch.discoveryurl

 The discovery of VMware vSphere Distributed Switches.
 Return value: **JSON object**.

Parameters:

- **url** - the VMware service URL.

vmware.dvswitch.fetchports.get[url,uuid,<filter>,<mode>]

 The VMware vSphere Distributed Switch ports data.
 Return value: **JSON object**.

Parameters:

- **url** - the VMware service URL;
- **uuid** - the VMware DVSwitch global unique identifier.
- **filter** - a single string with comma-separated criteria for selecting ports;
- **mode** - *state* (all XML without "config" XML nodes, default) or *full*.

The **filter** parameter supports the **criteria** available in the VMware data object DistributedVirtualSwitchPortCriteria.

Example:

```
vmware.dvswitch.fetchports.get [{"VMWARE.URL"}, {"VMWARE.DVS.UUID"}, "active:true,connected:false,host:host-18,
```

```
vmware.hv.alarms.get[url,uuid]
```

 The VMware hypervisor alarms data.
 Return value: **JSON object**.

Parameters:

- **url** - the VMware service URL;
- **uuid** - the VMware hypervisor global unique identifier.

vmware.hv.cluster.name[url,uuid]

 The VMware hypervisor cluster name.
 Return value: *String*.

Parameters:

- **url** - the VMware service URL;
- **uuid** - the VMware hypervisor global unique identifier.

vmware.hv.connectionstate[url,uuid]

 The VMware hypervisor connection state.
 Return value: *String: connected, disconnected, or notResponding*.

Parameters:

- **url** - the VMware service URL;
- **uuid** - the VMware hypervisor global unique identifier.

vmware.hv.cpu.usage[url,uuid]

 The VMware hypervisor processor usage (Hz).
 Return value: *Integer*.

Parameters:

- **url** - the VMware service URL;
- **uuid** - the VMware hypervisor global unique identifier.

vmware.hv.cpu.usage.perf[url,uuid]

 The VMware hypervisor processor usage as a percentage during the interval.
 Return value: *Float*.

Parameters:

- **url** - the VMware service URL;
- **uuid** - the VMware hypervisor global unique identifier.

vmware.hv.cpu.utilization[url,uuid]

 The VMware hypervisor processor usage as a percentage during the interval, depends on power management or HT.
 Return value: *Float*.

Parameters:

- **url** - the VMware service URL;
- **uuid** - the VMware hypervisor global unique identifier.

vmware.hv.datacenter.name[url,uuid]

 The VMware hypervisor datacenter name.
 Return value: *String*.

Parameters:

- **url** - the VMware service URL;
- **uuid** - the VMware hypervisor global unique identifier.

vmware.hv.datastore.discovery[url,uuid]

 The discovery of VMware hypervisor datastores.
 Return value: **JSON object**.

Parameters:

- **url** - the VMware service URL;
- **uuid** - the VMware hypervisor global unique identifier.

vmware.hv.datastore.list[url,uuid]

 The list of VMware hypervisor datastores.
 Return value: *String*.

Parameters:

- **url** - the VMware service URL;
- **uuid** - the VMware hypervisor global unique identifier.

Output example:

```
SSD-RAID1-VAULT1
SSD-RAID1-VAULT2
SSD-RAID10
```

vmware.hv.datastore.multipath[url,uuid,<datastore>,<partitionid>]

 The number of available datastore paths.
 Return value: *Integer*.

Parameters:

- **url** - the VMware service URL;
- **uuid** - the VMware hypervisor global unique identifier;
- **datastore** - the datastore UUID or name;
- **partitionid** - the internal ID of physical device from `vmware.hv.datastore.discovery`.

vmware.hv.datastore.read[url,uuid,datastore,<mode>]

 The average amount of time for a read operation from the datastore (milliseconds).
 Return value: *Integer*².

Parameters:

- **url** - the VMware service URL;

- **uuid** - the VMware hypervisor global unique identifier;
- **datastore** - the datastore UUID or name;
- **mode** - *latency* (default).

vmware.hv.datastore.size[url,uuid,datastore,<mode>]

 The VMware datastore space in bytes or in percentage from total.
 Return value: *Integer* - for bytes; *Float* - for percentage.

Parameters:

- **url** - the VMware service URL;
- **uuid** - the VMware hypervisor global unique identifier;
- **datastore** - the datastore UUID or name;
- **mode** - possible values: *total* (default), *free*, *pfree* (free percentage), *uncommitted*.

vmware.hv.datastore.write[url,uuid,datastore,<mode>]

 The average amount of time for a write operation to the datastore (milliseconds).
 Return value: *Integer*².

Parameters:

- **url** - the VMware service URL;
- **uuid** - the VMware hypervisor global unique identifier;
- **datastore** - the datastore UUID or name;
- **mode** - *latency* (default).

vmware.hv.discoveryurl

 The discovery of VMware hypervisors.
 Return value: *JSON object*.

Parameters:

- **url** - the VMware service URL.

vmware.hv.diskinfo.get[url,uuid]

 The VMware hypervisor disk data.
 Return value: *JSON object*.

Parameters:

- **url** - the VMware service URL;
- **uuid** - the VMware hypervisor global unique identifier.

vmware.hv.fullname[url,uuid]

 The VMware hypervisor name.
 Return value: *String*.

Parameters:

- **url** - the VMware service URL;
- **uuid** - the VMware hypervisor global unique identifier.

vmware.hv.hw.cpu.freq[url,uuid]

 The VMware hypervisor processor frequency (Hz).
 Return value: *Integer*.

Parameters:

- **url** - the VMware service URL;
- **uuid** - the VMware hypervisor global unique identifier.

vmware.hv.hw.cpu.model[url,uuid]

 The VMware hypervisor processor model.
 Return value: *String*.

Parameters:

- **url** - the VMware service URL;
- **uuid** - the VMware hypervisor global unique identifier.

vmware.hv.hw.cpu.num[url,uuid]

 The number of processor cores on VMware hypervisor.
 Return value: *Integer*.

Parameters:

- **url** - the VMware service URL;
- **uuid** - the VMware hypervisor global unique identifier.

vmware.hv.hw.cpu.threads[url,uuid]

 The number of processor threads on VMware hypervisor.
 Return value: *Integer*.

Parameters:

- **url** - the VMware service URL;
- **uuid** - the VMware hypervisor global unique identifier.

vmware.hv.hw.memory[url,uuid]

 The VMware hypervisor total memory size (bytes).
 Return value: *Integer*.

Parameters:

- **url** - the VMware service URL;
- **uuid** - the VMware hypervisor global unique identifier.

vmware.hv.hw.model[url,uuid]

 The VMware hypervisor model.
 Return value: *String*.

Parameters:

- **url** - the VMware service URL;
- **uuid** - the VMware hypervisor global unique identifier.

vmware.hv.hw.sensors.get[url,uuid]

 The VMware hypervisor hardware sensors value.
 Return value: **JSON object**.

Parameters:

- **url** - the VMware service URL;
- **uuid** - the VMware hypervisor global unique identifier.

vmware.hv.hw.serialnumber[url,uuid]

 The VMware hypervisor serial number.
 Return value: *String*.

Parameters:

- **url** - the VMware service URL;
- **uuid** - the VMware hypervisor global unique identifier.

This item works with vSphere API 6.7 and newer.

vmware.hv.hw.uuid[url,uuid]

 The VMware hypervisor BIOS UUID.
 Return value: *String*.

Parameters:

- **url** - the VMware service URL;
- **uuid** - the VMware hypervisor global unique identifier.

This item works with vSphere API 6.7 and newer.

vmware.hv.hw.vendor[url,uuid]

 The VMware hypervisor vendor name.
 Return value: *String*.

Parameters:

- **url** - the VMware service URL;
- **uuid** - the VMware hypervisor global unique identifier.

This item works with vSphere API 6.7 and newer.

vmware.hv.maintenance[url,uuid]

 The VMware hypervisor maintenance status.
 Return value: *0* - not in maintenance; *1* - in maintenance.

Parameters:

- **url** - the VMware service URL;
- **uuid** - the VMware hypervisor global unique identifier.

vmware.hv.memory.size.ballooned[url,uuid]

 The VMware hypervisor ballooned memory size (bytes).
 Return value: *Integer*.

Parameters:

- **url** - the VMware service URL;
- **uuid** - the VMware hypervisor global unique identifier.

vmware.hv.memory.used[url,uuid]

 The VMware hypervisor used memory size (bytes).
 Return value: *Integer*.

Parameters:

- **url** - the VMware service URL;
- **uuid** - the VMware hypervisor global unique identifier.

vmware.hv.net.if.discovery[url,uuid]

 The discovery of VMware hypervisor network interfaces.
 Return value: *JSON object*.

Parameters:

- **url** - the VMware service URL;
- **uuid** - the VMware hypervisor global unique identifier.

vmware.hv.network.in[url,uuid,<mode>]

 The VMware hypervisor network input statistics (bytes per second).
 Return value: *Integer*².

Parameters:

- **url** - the VMware service URL;
- **uuid** - the VMware hypervisor global unique identifier;
- **mode** - *bps* (default), *packets*, *dropped*, *errors*, *broadcast*.

vmware.hv.network.linkspeed[url,uuid,ifname]

 The VMware hypervisor network interface speed.
 Return value: *Integer*. Returns 0, if the network interface is down, otherwise the speed value of the interface.

Parameters:

- **url** - the VMware service URL;
- **uuid** - the VMware hypervisor global unique identifier;
- **ifname** - the interface name.

vmware.hv.network.out[url,uuid,<mode>]

 The VMware hypervisor network output statistics (bytes per second).
 Return value: *Integer*².

Parameters:

- **url** - the VMware service URL;
- **uuid** - the VMware hypervisor global unique identifier;
- **mode** - *bps* (default), *packets*, *dropped*, *errors*, *broadcast*.

vmware.hv.perfcounter[url,uuid,path,<instance>]

 The VMware hypervisor performance counter value.
 Return value: *Integer*².

Parameters:

- **url** - the VMware service URL;
- **uuid** - the VMware hypervisor global unique identifier;
- **path** - the performance counter path¹;
- **instance** - the performance counter instance. Use empty instance for aggregate values (default).

vmware.hv.property[url,uuid,prop]

 The VMware hypervisor property.
 Return value: *String*.

Parameters:

- **url** - the VMware service URL;
- **uuid** - the VMware hypervisor global unique identifier;
- **prop** - the property path.

vmware.hv.power[url,uuid,<max>]

 The VMware hypervisor power usage (W).
 Return value: *Integer*.

Parameters:

- **url** - the VMware service URL;
- **uuid** - the VMware hypervisor global unique identifier;
- **max** - the maximum allowed power usage.

vmware.hv.sensor.health.state[url,uuid]

 The VMware hypervisor health state rollup sensor.
 Return value: *Integer*: 0 - gray; 1 - green; 2 - yellow; 3 - red.

Parameters:

- **url** - the VMware service URL;
- **uuid** - the VMware hypervisor global unique identifier.

Note that the item might not work in VMware vSphere 6.5 and newer, because VMware has deprecated the *VMware Rollup Health State* sensor.

vmware.hv.sensors.get[url,uuid]

 The VMware hypervisor HW vendor state sensors.
 Return value: **JSON object**.

Parameters:

- **url** - the VMware service URL;
- **uuid** - the VMware hypervisor global unique identifier.

vmware.hv.status[url,uuid]

 The VMware hypervisor status.
 Return value: *Integer*: 0 - gray; 1 - green; 2 - yellow; 3 - red.

Parameters:

- **url** - the VMware service URL;
- **uuid** - the VMware hypervisor global unique identifier.

This item uses the host system overall status property.

vmware.hv.tags.get[url,uuid]

 The VMware hypervisor tags array.
 Return value: **JSON object**.

Parameters:

- **url** - the VMware service URL;
- **uuid** - the VMware hypervisor global unique identifier.

This item works with vSphere 6.5 and newer.

vmware.hv.uptime[url,uuid]

 The VMware hypervisor uptime (seconds).
 Return value: *Integer*.

Parameters:

- **url** - the VMware service URL;
- **uuid** - the VMware hypervisor global unique identifier.

This item uses the host system overall status property.

vmware.hv.version[url,uuid]

 The VMware hypervisor version.
 Return value: *String*.

Parameters:

- **url** - the VMware service URL;
- **uuid** - the VMware hypervisor global unique identifier.

vmware.hv.vm.num[url,uuid]

 The number of virtual machines on the VMware hypervisor.
 Return value: *Integer*.

Parameters:

- **url** - the VMware service URL;

- **uuid** - the VMware hypervisor global unique identifier.

vmware.rp.cpu.usage[url, rpid]

 The CPU usage in hertz during the interval on VMware Resource Pool.
 Return value: *Integer*.

Parameters:

- **url** - the VMware service URL;
- **rpid** - the VMware resource pool ID.

vmware.rp.memory[url, rpid, <mode>]

 The memory metrics of VMware resource pool.
 Return value: *Integer*.

Parameters:

- **url** - the VMware service URL;
- **rpid** - the VMware resource pool ID;
- **mode** - possible values:
consumed (default) - the amount of host physical memory consumed for backing up guest physical memory pages
ballooned - the amount of guest physical memory reclaimed from the virtual machine by the balloon driver in the guest
overhead - the host physical memory consumed by ESXi data structures for running the virtual machines

vmware.alarms.geturl

 The VMware virtual center alarms data.
 Return value: *JSON object*.

Parameters:

- **url** - the VMware service URL.

vmware.vm.alarms.get[url, uuid]

 The VMware virtual machine alarms data.
 Return value: *JSON object*.

Parameters:

- **url** - the VMware service URL;
- **uuid** - the VMware virtual machine global unique identifier.

vmware.vm.attribute[url, uuid, name]

 The VMware virtual machine custom attribute value.
 Return value: *String*.

Parameters:

- **url** - the VMware service URL;
- **uuid** - the VMware virtual machine global unique identifier;
- **name** - the custom attribute name.

vmware.vm.cluster.name[url, uuid]

 The VMware virtual machine name.
 Return value: *String*.

Parameters:

- **url** - the VMware service URL;
- **uuid** - the VMware virtual machine global unique identifier;
- **name** - the custom attribute name.

vmware.vm.consolidationneeded[url, uuid]

 The VMware virtual machine disk requires consolidation.
 Return value: *String*: *true* - consolidation is needed; *false* - consolidation is not needed.

Parameters:

- **url** - the VMware service URL;
- **uuid** - the VMware virtual machine global unique identifier.

vmware.vm.cpu.latency[url, uuid]

 The percentage of time the virtual machine is unable to run because it is contending for access to the physical CPU(s).
 Return value: *Float*.

Parameters:

- **url** - the VMware service URL;

- **uuid** - the VMware virtual machine global unique identifier.

vmware.vm.cpu.num[url,uuid]

 The number of processors on VMware virtual machine.
 Return value: *Integer*.

Parameters:

- **url** - the VMware service URL;
- **uuid** - the VMware virtual machine global unique identifier.

vmware.vm.cpu.readiness[url,uuid,<instance>]

 The percentage of time that the virtual machine was ready, but could not get scheduled to run on the physical CPU.
 Return value: *Float*.

Parameters:

- **url** - the VMware service URL;
- **uuid** - the VMware virtual machine global unique identifier;
- **instance** - the CPU instance.

vmware.vm.cpu.ready[url,uuid]

 The time (in milliseconds) that the virtual machine was ready, but could not get scheduled to run on the physical CPU. CPU ready time is dependent on the number of virtual machines on the host and their CPU loads (%).
 Return value: *Integer*².

Parameters:

- **url** - the VMware service URL;
- **uuid** - the VMware virtual machine global unique identifier.

vmware.vm.cpu.swapwait[url,uuid,<instance>]

 The percentage of CPU time spent waiting for swap-in.
 Return value: *Float*.

Parameters:

- **url** - the VMware service URL;
- **uuid** - the VMware virtual machine global unique identifier;
- **instance** - the CPU instance.

vmware.vm.cpu.usage[url,uuid]

 The VMware virtual machine processor usage (Hz).
 Return value: *Integer*.

Parameters:

- **url** - the VMware service URL;
- **uuid** - the VMware virtual machine global unique identifier.

vmware.vm.cpu.usage.perf[url,uuid]

 The VMware virtual machine processor usage as a percentage during the interval.
 Return value: *Float*.

Parameters:

- **url** - the VMware service URL;
- **uuid** - the VMware virtual machine global unique identifier.

vmware.vm.datacenter.name[url,uuid]

 The VMware virtual machine datacenter name.
 Return value: *String*.

Parameters:

- **url** - the VMware service URL;
- **uuid** - the VMware virtual machine global unique identifier.

vmware.vm.discoveryurl

 The discovery of VMware virtual machines.
 Return value: **JSON object**.

Parameters:

- **url** - the VMware service URL.

vmware.vm.guest.memory.size.swapped[url,uuid]

 The amount of guest physical memory that is swapped out to the swap space (KB).
 Return value: *Integer*.

Parameters:

- **url** - the VMware service URL;
- **uuid** - the VMware virtual machine global unique identifier.

vmware.vm.guest.osuptime[url,uuid]

 The total time elapsed since the last operating system boot-up (in seconds).
 Return value: *Integer*.

Parameters:

- **url** - the VMware service URL;
- **uuid** - the VMware virtual machine global unique identifier.

vmware.vm.hv.maintenance[url,uuid]

 The VMware virtual machine hypervisor maintenance status.
 Return value: *0* - not in maintenance; *1* - in maintenance.

Parameters:

- **url** - the VMware service URL;
- **uuid** - the VMware virtual machine global unique identifier.

vmware.vm.hv.name[url,uuid]

 The VMware virtual machine hypervisor name.
 Return value: *String*.

Parameters:

- **url** - the VMware service URL;
- **uuid** - the VMware virtual machine global unique identifier.

vmware.vm.memory.size[url,uuid]

 The VMware virtual machine total memory size (bytes).
 Return value: *Integer*.

Parameters:

- **url** - the VMware service URL;
- **uuid** - the VMware virtual machine global unique identifier.

vmware.vm.memory.size.ballooned[url,uuid]

 The VMware virtual machine ballooned memory size (bytes).
 Return value: *Integer*.

Parameters:

- **url** - the VMware service URL;
- **uuid** - the VMware virtual machine global unique identifier.

vmware.vm.memory.size.compressed[url,uuid]

 The VMware virtual machine compressed memory size (bytes).
 Return value: *Integer*.

Parameters:

- **url** - the VMware service URL;
- **uuid** - the VMware virtual machine global unique identifier.

vmware.vm.memory.size.consumed[url,uuid]

 The amount of host physical memory consumed for backing up guest physical memory pages (KB).
 Return value: *Integer*.

Parameters:

- **url** - the VMware service URL;
- **uuid** - the VMware virtual machine global unique identifier.

vmware.vm.memory.size.private[url,uuid]

 The VMware virtual machine private memory size (bytes).
 Return value: *Integer*.

Parameters:

- **url** - the VMware service URL;

- **uuid** - the VMware virtual machine global unique identifier.

vmware.vm.memory.size.shared[url,uuid]

 The VMware virtual machine shared memory size (bytes).
 Return value: *Integer*.

Parameters:

- **url** - the VMware service URL;
- **uuid** - the VMware virtual machine global unique identifier.

vmware.vm.memory.size.swapped[url,uuid]

 The VMware virtual machine swapped memory size (bytes).
 Return value: *Integer*.

Parameters:

- **url** - the VMware service URL;
- **uuid** - the VMware virtual machine global unique identifier.

vmware.vm.memory.size.usage.guest[url,uuid]

 The VMware virtual machine guest memory usage (bytes).
 Return value: *Integer*.

Parameters:

- **url** - the VMware service URL;
- **uuid** - the VMware virtual machine global unique identifier.

vmware.vm.memory.size.usage.host[url,uuid]

 The VMware virtual machine host memory usage (bytes).
 Return value: *Integer*.

Parameters:

- **url** - the VMware service URL;
- **uuid** - the VMware virtual machine global unique identifier.

vmware.vm.memory.usage[url,uuid]

 The percentage of host physical memory that has been consumed.
 Return value: *Float*.

Parameters:

- **url** - the VMware service URL;
- **uuid** - the VMware virtual machine global unique identifier.

vmware.vm.net.if.discovery[url,uuid]

 The discovery of VMware virtual machine network interfaces.
 Return value: *JSON object*.

Parameters:

- **url** - the VMware service URL;
- **uuid** - the VMware virtual machine global unique identifier.

vmware.vm.net.if.in[url,uuid,instance,<mode>]

 The VMware virtual machine network interface input statistics (bytes/packets per second).
 Return value: *Integer*².

Parameters:

- **url** - the VMware service URL;
- **uuid** - the VMware virtual machine global unique identifier;
- **instance** - the network interface instance;
- **mode** - *bps* (default) or *pps* - bytes or packets per second.

vmware.vm.net.if.out[url,uuid,instance,<mode>]

 The VMware virtual machine network interface output statistics (bytes/packets per second).
 Return value: *Integer*².

Parameters:

- **url** - the VMware service URL;
- **uuid** - the VMware virtual machine global unique identifier;
- **instance** - the network interface instance;
- **mode** - *bps* (default) or *pps* - bytes or packets per second.

vmware.vm.net.if.usage[url,uuid,<instance>]

 The VMware virtual machine network utilization (combined transmit-rates and receive-rates) during the interval (KBps).
 Return value: *Integer*.

Parameters:

- **url** - the VMware service URL;
- **uuid** - the VMware virtual machine global unique identifier;
- **instance** - the network interface instance.

vmware.vm.perfcounter[url,uuid,path,<instance>]

 The VMware virtual machine performance counter value.
 Return value: *Integer*².

Parameters:

- **url** - the VMware service URL;
- **uuid** - the VMware virtual machine global unique identifier;
- **path** - the performance counter path¹;
- **instance** - the performance counter instance. Use empty instance for aggregate values (default).

vmware.vm.powerstate[url,uuid]

 The VMware virtual machine power state.
 Return value: 0 - poweredOff; 1 - poweredOn; 2 - suspended.

Parameters:

- **url** - the VMware service URL;
- **uuid** - the VMware virtual machine global unique identifier.

vmware.vm.property[url,uuid,prop]

 The VMware virtual machine property.
 Return value: *String*.

Parameters:

- **url** - the VMware service URL;
- **uuid** - the VMware virtual machine global unique identifier;
- **prop** - the property path.

vmware.vm.snapshot.get[url,uuid]

 The VMware virtual machine snapshot state.
 Return value: *JSON object*.

Parameters:

- **url** - the VMware service URL;
- **uuid** - the VMware virtual machine global unique identifier.

vmware.vm.state[url,uuid]

 The VMware virtual machine state.
 Return value: *String*: *notRunning*, *resetting*, *running*, *shuttingDown*, *standby*, or *unknown*.

Parameters:

- **url** - the VMware service URL;
- **uuid** - the VMware virtual machine global unique identifier.

vmware.vm.storage.committed[url,uuid]

 The VMware virtual machine committed storage space (bytes).
 Return value: *Integer*.

Parameters:

- **url** - the VMware service URL;
- **uuid** - the VMware virtual machine global unique identifier.

vmware.vm.storage.readoio[url,uuid,instance]

 The average number of outstanding read requests to the virtual disk during the collection interval.
 Return value: *Integer*.

Parameters:

- **url** - the VMware service URL;
- **uuid** - the VMware virtual machine global unique identifier;
- **instance** - the disk device instance.

vmware.vm.storage.totalreadlatency[url,uuid,instance]

 The average time a read from the virtual disk takes (milliseconds).
 Return value: *Integer*.

Parameters:

- **url** - the VMware service URL;
- **uuid** - the VMware virtual machine global unique identifier;
- **instance** - the disk device instance.

vmware.vm.storage.totalwritelatency[url,uuid,instance]

 The average time a write to the virtual disk takes (milliseconds).
 Return value: *Integer*.

Parameters:

- **url** - the VMware service URL;
- **uuid** - the VMware virtual machine global unique identifier;
- **instance** - the disk device instance.

vmware.vm.storage.uncommitted[url,uuid]

 The VMware virtual machine uncommitted storage space (bytes).
 Return value: *Integer*.

Parameters:

- **url** - the VMware service URL;
- **uuid** - the VMware virtual machine global unique identifier.

vmware.vm.storage.unshared[url,uuid]

 The VMware virtual machine unshared storage space (bytes).
 Return value: *Integer*.

Parameters:

- **url** - the VMware service URL;
- **uuid** - the VMware virtual machine global unique identifier.

vmware.vm.storage.writeio[url,uuid,instance]

 The average number of outstanding write requests to the virtual disk during the collection interval.
 Return value: *Integer*.

Parameters:

- **url** - the VMware service URL;
- **uuid** - the VMware virtual machine global unique identifier;
- **instance** - the disk device instance.

vmware.vm.tags.get[url,uuid]

 The VMware virtual machine tags array.
 Return value: **JSON object**.

Parameters:

- **url** - the VMware service URL;
- **uuid** - the VMware virtual machine global unique identifier.

This item works with vSphere 6.5 and newer.

vmware.vm.tools[url,uuid,mode]

 The VMware virtual machine guest tools state.
 Return value: *String*: *guestToolsExecutingScripts* - VMware Tools is starting; *guestToolsNotRunning* - VMware Tools is not running; *guestToolsRunning* - VMware Tools is running.

Parameters:

- **url** - the VMware service URL;
- **uuid** - the VMware virtual machine global unique identifier;
- **mode** - *version, status*.

vmware.vm.uptime[url,uuid]

 The VMware virtual machine uptime (seconds).
 Return value: *Integer*.

Parameters:

- **url** - the VMware service URL;
- **uuid** - the VMware virtual machine global unique identifier.

vmware.vm.vfs.dev.discovery[url,uuid]

 The discovery of VMware virtual machine disk devices.
 Return value: **JSON object**.

Parameters:

- **url** - the VMware service URL;
- **uuid** - the VMware virtual machine global unique identifier.

vmware.vm.vfs.dev.read[url,uuid,instance,<mode>]

 The VMware virtual machine disk device read statistics (bytes/operations per second).
 Return value: *Integer*².

Parameters:

- **url** - the VMware service URL;
- **uuid** - the VMware virtual machine global unique identifier;
- **instance** - the disk device instance;
- **mode** - *bps* (default) or *ops* - bytes or operations per second.

vmware.vm.vfs.dev.write[url,uuid,instance,<mode>]

 The VMware virtual machine disk device write statistics (bytes/operations per second).
 Return value: *Integer*².

Parameters:

- **url** - the VMware service URL;
- **uuid** - the VMware virtual machine global unique identifier;
- **instance** - the disk device instance;
- **mode** - *bps* (default) or *ops* - bytes or operations per second.

vmware.vm.vfs.fs.discovery[url,uuid]

 The discovery of VMware virtual machine file systems.
 Return value: **JSON object**.

Parameters:

- **url** - the VMware service URL;
- **uuid** - the VMware virtual machine global unique identifier.

VMware Tools must be installed on the guest virtual machine for this item to work.

vmware.vm.vfs.fs.size[url,uuid,fsname,<mode>]

 The VMware virtual machine file system statistics (bytes/percentages).
 Return value: *Integer*.

Parameters:

- **url** - the VMware service URL;
- **uuid** - the VMware virtual machine global unique identifier;
- **fsname** - the file system name;
- **mode** - *total*, *free*, *used*, *pfree*, or *pusd*.

VMware Tools must be installed on the guest virtual machine for this item to work.

Footnotes

¹ See [Creating custom performance counter names for VMware](#).

² The value of these items is obtained from VMware performance counters and the `VMwarePerfFrequency` [parameter](#) is used to refresh their data in Zabbix VMware cache:

- vmware.cl.perfcounter
- vmware.hv.datastore.read
- vmware.hv.datastore.write
- vmware.hv.network.in
- vmware.hv.network.out
- vmware.hv.perfcounter
- vmware.vm.cpu.ready
- vmware.vm.net.if.in
- vmware.vm.net.if.out
- vmware.vm.perfcounter
- vmware.vm.vfs.dev.read
- vmware.vm.vfs.dev.write

More info

See [Virtual machine monitoring](#) for detailed information how to configure Zabbix to monitor VMware environments.

2 Virtual machine discovery key fields

The following table lists fields returned by virtual machine related discovery keys.

Item key	Field	Retrieved content
vmware.cluster.discovery		
Performs cluster discovery.	{#CLUSTER.ID}	Cluster identifier.
	{#CLUSTER.NAME}	Cluster name.
	"resource_pool"	An array containing resource pool data, including resource group ID, tags array, resource pool path, number of virtual machines. Array structure: [{"rpid":"resource group id", "tags":[{}], "rpath":"resource group path", "vm_count":0 }] For "tags" array structure, see the "tags" field.
"tags"	An array containing tags with tag name, description and category. Array structure: [{"tag":"tag name", "tag_description":"tag description", "category":"tag category" }]	
vmware.datastore.discovery		
Performs datastore discovery.	{#DATASTORE}	Datastore name.
	{#DATASTORE.EXTENT}	An array containing datastore extent partition ID and instance name. Array structure: [{"partitionid":1, "instance":"name" }]
	{#DATASTORE.TYPE}	Datastore type.
	{#DATASTORE.UUID}	Value examples: VMFS, NFS, vsan, etc. Datastore identifier.
"tags"	An array containing tags with tag name, description and category. Array structure: [{"tag":"tag name", "tag_description":"tag description", "category":"tag category" }]	
vmware.dc.discovery		
Performs datacenter discovery.	{#DATACENTER}	Datacenter name.
	{#DATACENTERID}	Datacenter identifier.

Item key

	"tags"	An array containing tags with tag name, description and category. Array structure: [{"tag": "tag name", "tag_description": "tag description", "category": "tag category" }]
vmware.dvswitch.discovery		
Performs vSphere distributed switches discovery.	{#DVS.NAME}	Switch name.
	{#DVS.UUID}	Switch identifier.
vmware.hv.discovery		
Performs hypervisor discovery.	{#HV.UUID}	Unique hypervisor identifier.
	{#HV.ID}	Hypervisor identifier (HostSystem managed object name).
	{#HV.NAME}	Hypervisor name.
	{#HV.NETNAME}	Hypervisor network host name.
	{#HV.IP}	Hypervisor IP address, might be empty.
		In case of an HA configuration with multiple net interfaces, the following selection priority for interface is observed: - prefer the IP which shares the IP-subnet with the vCenter IP; - prefer the IP from IP-subnet with default gateway; - prefer the IP from interface with the lowest ID.
	{#CLUSTER.NAME}	Cluster name, might be empty.
	{#DATACENTER.NAME}	Datacenter name.
	{#PARENT.NAME}	Name of container that stores the hypervisor.
	{#PARENT.TYPE}	Type of container in which the hypervisor is stored. The values could be Datacenter, Folder, ClusterComputeResource, VMware, where "VMware" stands for unknown container type.
	"resource_pool"	An array containing resource pool data, including resource group ID, tags array, resource pool path, number of virtual machines. Array structure: [{"rpid": "resource group id", "tags": [{}], "rpath": "resource group path", "vm_count": 0 }]
		For "tags" array structure, see the "tags" field.
	"tags"	An array containing tags with tag name, description and category. Array structure: [{"tag": "tag name", "tag_description": "tag description", "category": "tag category" }]
vmware.hv.datastore.discovery		
Performs hypervisor datastore discovery. Note that multiple hypervisors can use the same datastore.	{#DATASTORE}	Datastore name.
	{#DATASTORE.TYPE}	Datastore type. Value examples: VMFS, NFS, vsan, etc.

Item key

{#DATASTORE.UUID}	Datastore identifier.
{#MULTIPATH.COUNT}	Registered number of datastore paths.
{#MULTIPATH.PARTITION.COUNT}	Number of available disk partitions.
"datastore_extent"	An array containing datastore extent instance name and partition ID.

Array structure:

```
[{  
  "partitionid":1,  
  "instance":"name"  
}]
```

"tags"	An array containing tags with tag name, description and category.
--------	---

Array structure:

```
[{  
  "tag":"tag name",  
  "tag_description":"tag description",  
  "category":"tag category"  
}]
```

vmware.hv.net.if.discovery

Performs hypervisor network interfaces discovery.

{#IFNAME}	Interface name.
{#IFDRIVER}	Interface driver.
{#IFDUPLEX}	Interface duplex settings.
{#IFSPEED}	Interface speed.
{#IFMAC}	Interface mac address.

vmware.vm.discovery

Performs virtual machine discovery.

{#VM.UUID}	Unique virtual machine identifier.
{#VM.ID}	Virtual machine identifier (VirtualMachine managed object name).
{#VM.NAME}	Virtual machine name.
{#HV.NAME}	Hypervisor name.
{#HV.UUID}	Unique hypervisor identifier.
{#HV.ID}	Hypervisor identifier (HostSystem managed object name).
{#CLUSTER.NAME}	Cluster name, might be empty.
{#DATACENTER.NAME}	Datacenter name.
{#DATASTORE.NAME}	Datastore name.
{#DATASTORE.UUID}	Datastore identifier.
{#VM.IP}	Virtual machine IP address, might be empty.
{#VM.DNS}	Virtual machine DNS name, might be empty.
{#VM.GUESTFAMILY}	Guest virtual machine OS family, might be empty.
{#VM.GUESTFULLNAME}	Full guest virtual machine OS name, might be empty.
{#VM.FOLDER}	The chain of virtual machine parent folders, can be used as value for nested groups; folder names are combined with "/". Might be empty.
{#VM.TOOLS.STATUS}	VMware virtual machine tools state.
{#VM.POWERSTATE}	VMware virtual machine power state (poweredOff, poweredOn, or suspended).
{#VM.RPOOL.ID}	Resource pool identifier.
{#VM.RPOOL.PATH}	Full resource pool path excluding the "root" name "Resources". Folder names are combined with "/".
{#VM.SNAPSHOT.COUNT}	Number of VM snapshots.
"tags"	An array containing tags with tag name, description and category.

Array structure:

```
[{  
  "tag":"tag name",  
  "tag_description":"tag description",  
  "category":"tag category"  
}]
```

Item key

"vm_customattribute" An array of virtual machine custom attributes (if defined).

Array structure:

```
[{
  "name": "custom field name",
  "value": "custom field value"
}]
```

"net_if" An array of virtual machine network interfaces.

Array structure:

```
[{
  "ifname": "interface name",
  "ifdesc": "interface description",
  "ifmac": "00:00:00:00:00:00",
  "ifconnected": true,
  "iftype": "interface type",
  "ifbackingdevice": "interface backing device",
  "ifdvswitch_uuid": "interface switch uuid",
  "ifdvswitch_portgroup": "interface switch port group",
  "ifdvswitch_port": "interface switch port",
  "ifip": ["interface ip addresses"]
}]
```

For the description of returned data, see the "vmware.vm.net.if.discovery" item key.

vmware.vm.net.if.discovery

Performs virtual machine network interface discovery.

{#IFNAME}

Network interface name.

{#IFDESC}

Interface description.

{#IFMAC}

Interface mac address.

{#IFCONNECTED}

Interface connection status (false - disconnected; true - connected).

{#IFTYPE}

Interface type.

{#IFBACKINGDEVICE}

Name of the backing device.

{#IFDVSWITCH.UUID}

Unique vSphere Distributed Switch identifier.

{#IFDVSWITCH.PORTGROUP}

Distributed port group.

{#IFDVSWITCH.PORT}

vSphere Distributed Switch port.

"ifip"

An array of interface addresses.

vmware.vm.vfs.dev.discovery

Performs virtual machine disk device discovery.

{#DISKNAME}

Disk device name.

vmware.vm.vfs.fs.discovery

Performs virtual machine file system discovery.

{#FSNAME}

File system name.

3 JSON examples for VMware items

Overview This section provides additional information about JSON objects returned by various VMware [items](#).

vmware.*.alarms.get The items **vmware.alarms.get[]**, **vmware.cluster.alarms.get[]**, **vmware.datastore.alarms.get[]**, **vmware.dc.alarms.get[]**, **vmware.hv.alarms.get[]**, **vmware.vm.alarms.get[]** return JSON objects with the following structure (values are provided as an example):

```
{
  "alarms": [
```



```

{
  "name": "Host connection and power state",
  "system_name": "alarm.HostConnectionStateAlarm",
  "description": "Default alarm to monitor host connection and power state",
  "enabled": true,
  "key": "alarm-1.host-2013",
  "time": "2022-06-27T05:27:38.759976Z",
  "overall_status": "red",
  "acknowledged": false
},
{
  "name": "Host memory usage",
  "system_name": "alarm.HostMemoryUsageAlarm",
  "description": "Default alarm to monitor host memory usage",
  "enabled": true,
  "key": "alarm-4.host-1004",
  "time": "2022-05-16T13:32:42.47863Z",
  "overall_status": "yellow",
  "acknowledged": false
},
{
  // other alarms
}
]
}

```

vmware.*.tags.get The items **vmware.cluster.tags.get[]**, **vmware.datastore.tags.get[]**, **vmware.dc.tags.get[]**, **vmware.hv.tags.get[]**, **vmware.vm.tags.get[]** return JSON objects with the following structure (values are provided as an example):

```

{
  "tags": [
    {
      "name": "Windows",
      "description": "tag for cat OS type",
      "category": "OS type"
    },
    {
      "name": "SQL Server",
      "description": "tag for cat application name",
      "category": "application name"
    },
    {
      // other tags
    }
  ]
}

```

vmware.hv.diskinfo.get The item **vmware.hv.diskinfo.get[]** returns JSON objects with the following structure (values are provided as an example):

```

[
  {
    "instance": "mpx.vmhba32:C0:T0:L0",
    "hv_uuid": "8002299e-d7b9-8728-d224-76004bbb6100",
    "datastore_uuid": "",
    "operational_state": [
      "ok"
    ],
    "lun_type": "disk",
    "queue_depth": 1,
    "model": "USB DISK",
    "vendor": "SMI Corp",
  }
]

```

```

    "revision": "1100",
    "serial_number": "CCYYMMDDHHmmSS9S62CK",
    "vsan": {}
  },
  {
    // other instances
  }
]

```

vmware.dvswitch.fetchports.get The item **vmware.dvswitch.fetchports.get[]** returns JSON objects with the following structure (values are provided as an example):

```

{
  "FetchDVPortsResponse":
  {
    "returnval": [
      {
        "key": "0",
        "dvsUuid": "50 36 6a 24 25 c0 10 9e-05 4a f6 ea 4e 3d 09 88",
        "portgroupKey": "dvportgroup-2023",
        "proxyHost":
        {
          "@type": "HostSystem",
          "#text": "host-2021"
        },
        "connectee":
        {
          "connectedEntity":
          {
            "@type": "HostSystem",
            "#text": "host-2021"
          },
          "nicKey": "vmnic0",
          "type": "pnic"
        },
        "conflict": "false",
        "state":
        {
          "runtimeInfo":
          {
            "linkUp": "true",
            "blocked": "false",
            "vlanIds":
            {
              "start": "0",
              "end": "4094"
            },
            "trunkingMode": "true",
            "linkPeer": "vmnic0",
            "macAddress": "00:00:00:00:00:00",
            "statusDetail": null,
            "vmDirectPathGen2Active": "false",
            "vmDirectPathGen2InactiveReasonOther": "portNptIncompatibleConnectee"
          },
          "stats":
          {
            "packetsInMulticast": "2385470",
            "packetsOutMulticast": "45",
            "bytesInMulticast": "309250248",
            "bytesOutMulticast": "5890",
            "packetsInUnicast": "155601537",
            "packetsOutUnicast": "113008658",
            "bytesInUnicast": "121609489384",

```

```

        "bytesOutUnicast": "47240279759",
        "packetsInBroadcast": "1040420",
        "packetsOutBroadcast": "7051",
        "bytesInBroadcast": "77339771",
        "bytesOutBroadcast": "430392",
        "packetsInDropped": "0",
        "packetsOutDropped": "0",
        "packetsInException": "0",
        "packetsOutException": "0"
    }
},
"connectionCookie": "1702765133",
"lastStatusChange": "2022-03-25T14:01:11Z",
"hostLocalPort": "false"
},
{
    //other keys
}
]
}
}

```

vmware.hv.hw.sensors.get The item **vmware.hv.hw.sensors.get[]** returns JSON objects with the following structure (values are provided as an example):

```

{
    "val":
    {
        "@type": "HostHardwareStatusInfo",
        "storageStatusInfo": [
            {
                "name": "Intel Corporation HD Graphics 630 #2",
                "status":
                {
                    "label": "Unknown",
                    "summary": "Cannot report on the current status of the physical element",
                    "key": "Unknown"
                }
            },
            {
                "name": "Intel Corporation 200 Series/Z370 Chipset Family USB 3.0 xHCI Controller #20",
                "status":
                {
                    "label": "Unknown",
                    "summary": "Cannot report on the current status of the physical element",
                    "key": "Unknown"
                }
            },
            {
                // other hv hw sensors
            }
        ]
    }
}

```

vmware.hv.sensors.get The item **vmware.hv.sensors.get[]** returns JSON objects with the following structure (values are provided as an example):

```

{
    "val":
    {
        "@type": "ArrayOfHostNumericSensorInfo", "HostNumericSensorInfo": [
            {

```

```

        "@type": "HostNumericSensorInfo",
        "name": "System Board 1 PwrMeter Output --- Normal",
        "healthState":
            {
                "label": "Green",
                "summary": "Sensor is operating under normal conditions",
                "key": "green"
            },
        "currentReading": "10500",
        "unitModifier": "-2",
        "baseUnits": "Watts",
        "sensorType": "other"
    },
    {
        "@type": "HostNumericSensorInfo",
        "name": "Power Supply 1 PS 1 Output --- Normal",
        "healthState":
            {
                "label": "Green",
                "summary": "Sensor is operating under normal conditions",
                "key": "green"
            },
        "currentReading": "10000",
        "unitModifier": "-2",
        "baseUnits": "Watts",
        "sensorType": "power"
    },
    {
        // other hv sensors
    }
]
}

```

vmware.vm.snapshot.get If any snapshots exist, the item **vmware.snapshot.get[]** returns a JSON object with the following structure (values are provided as an example):

```

{
  "snapshot": [
    {
      "name": "VM Snapshot 4%2f1%2f2022, 9:16:39 AM",
      "description": "Descr 1",
      "createtime": "2022-04-01T06:16:51.761Z",
      "size": 5755795171,
      "uniquesize": 5755795171
    },
    {
      "name": "VM Snapshot 4%2f1%2f2022, 9:18:21 AM",
      "description": "Descr 2",
      "createtime": "2022-04-01T06:18:29.164999Z",
      "size": 118650595,
      "uniquesize": 118650595
    },
    {
      "name": "VM Snapshot 4%2f1%2f2022, 9:37:29 AM",
      "description": "Descr 3",
      "createtime": "2022-04-01T06:37:53.534999Z",
      "size": 62935016,
      "uniquesize": 62935016
    }
  ],
  "count": 3,
  "latestdate": "2022-04-01T06:37:53.534999Z",

```

```
"latestage": 22729203,  
"oldestdate": "2022-04-01T06:16:51.761Z",  
"oldestage": 22730465,  
"size": 5937380782,  
"uniquesize": 5937380782  
}
```

If no snapshot exists, the item `vmware.snapshot.get[]` returns a JSON object with empty values:

```
{  
  "snapshot": [],  
  "count": 0,  
  "latestdate": null,  
  "latestage": 0,  
  "oldestdate": null,  
  "oldestage": 0,  
  "size": 0,  
  "uniquesize": 0  
}
```

4 VMware monitoring setup example

Overview

The following example describes how to set up Zabbix for monitoring VMware virtual machines. This involves:

- creating a host that represents your VMware environment;
- creating a low-level discovery rule that discovers virtual machines in your VMware environment;
- creating a host prototype, based on which Zabbix will generate real hosts for virtual machines discovered by the low-level discovery rule.

Prerequisites

Note:

This example does not cover the configuration of VMware. It is assumed that VMware is already configured.

Before proceeding, set the `StartVMwareCollectors` parameter in Zabbix server configuration file to 2 or more (the default value is 0).

Create a host

1. Go to *Data collection* → *Hosts*.
2. **Create** a host:
 - In the *Host name* field, enter a host name (for example, "VMware VMs").
 - In the *Host groups* field, type or select a host group (for example, "Virtual machines").

New host ? X

Host **IPMI** Tags Macros Inventory Encryption Value mapping

* Host name

Visible name

Templates

* Host groups

Interfaces No interfaces are defined.

[Add](#)

Description

Monitored by proxy

Enabled

- In the *Macros* tab, set the following host macros:
 - {VMWARE.URL} - VMware service (ESXi hypervisor) SDK URL (https://servername/sdk)
 - {VMWARE.USERNAME} - VMware service user name
 - {VMWARE.PASSWORD} - VMware service {VMWARE.USERNAME} user password

New host ? X

Host IPMI Tags **Macros 3** Inventory Encryption Value mapping

Host macros **Inherited and host macros**

Macro	Value		Description	
{VMWARE.URL}	https://servername/sdk	T v	description	Remove
{VMWARE.USERNAME}	username	T v	description	Remove
{VMWARE.PASSWORD}	*****	🔒 v	description	Remove

[Add](#)

3. Click the *Add* button to create the host. This host will represent your VMware environment.

Create a low-level discovery rule

1. Click *Discovery* for the created host to go to the list of low-level discovery rules for that host.

2. **Create** a low-level discovery rule:

- In the *Name* field, enter a low-level discovery rule name (for example, "Discover VMware VMs").
- In the *Type* field, select "Simple check".
- In the *Key* field, enter the built-in item key for discovering VMware virtual machines: `vmware.vm.discovery[{{VMWARE.URL}}`
- In the *User name* and *Password* fields, enter the corresponding macros previously configured on the host.

Discovery rule Preprocessing LLD macros Filters Overrides

* Name

Type

* Key

Host interface

User name

Password

* Update interval

Custom intervals

Type	Interval	Period	Action
Flexible Scheduling	50s	1-7,00:00-24:00	Remove

[Add](#)

* Keep lost resources period

Description

Enabled

3. Click the *Add* button to create the low-level discovery rule. This discovery rule will discover virtual machines in your VMware environment.

Create a host prototype

1. In the list of low-level discovery rules, click *Host prototypes* for the previously created low-level discovery rule.
2. **Create** a host prototype. Since host prototypes are blueprints for creating hosts through low-level discovery rules, most fields will contain **low-level discovery macros**. This ensures that the hosts are created with properties based on the **content retrieved** by the previously created low-level discovery rule.
 - In the *Host name* field, enter the macro `{#VM.UUID}`.
 - In the *Visible name* field, enter the macro `{#VM.NAME}`.
 - In the *Templates* field, enter or select the "VMware Guest" template. This template contains **VMware items** and discovery rules for monitoring the power state of a virtual machine, CPU usage, memory usage, network devices, etc.
 - In the *Host groups* field, enter or select a host group (for example, "Discovered hosts").
 - In the *Interfaces* field, add a custom **host interface**. Then, enter the macro `{#VM.DNS}` in the *DNS name* field, or enter the macro `{#VM.IP}` in the *IP address* field. Alternatively, if your VMware environment virtual machines have multiple interfaces, proceed to the *Advanced host interface configuration* section. Configuring a custom host interface is necessary for the correct functioning of the *VMware Guest* template.

Host IPMI Tags Macros **Inventory** Encryption

* Host name

Visible name

Templates ✕ type here to search

* Host groups ✕ type here to search

Group prototypes

Interfaces

Type	IP address	DNS name	Connect to	Port	Default
Agent	<input style="width: 100px;" type="text"/>	<input style="width: 100px;" type="text" value="{#VM.DNS}"/>	IP <input checked="" type="radio"/> DNS <input type="radio"/>	<input style="width: 50px;" type="text" value="10050"/>	<input checked="" type="radio"/> <input type="button" value="Remove"/>

Monitored by proxy

Create enabled

Discover

- In the *Macros* tab, set the `{$VMWARE.VM.UUID}` macro with the value `{#VM.UUID}`. This is necessary for the correct functioning of the *VMware Guest* template that uses this macro as a host-level user macro in item parameters (for example, `vmware.vm.net.if.discovery[{$VMWARE.URL}, {$VMWARE.VM.UUID}]`).

Host IPMI Tags **Macros 1** Inventory Encryption

Host prototype macros Inherited and host prototype macros

Macro	Value
<input style="width: 150px;" type="text" value="{\$VMWARE.VM.UUID}"/>	<input style="width: 150px;" type="text" value="{#VM.UUID}"/> <input style="font-size: 8px;" type="button" value="T"/>

3. Click the *Add* button to create the host prototype. This host prototype will be used to create hosts for virtual machines discovered by the previously created low-level discovery rule.

View hosts and metrics

After the host prototype has been created, the low-level discovery rule will create hosts for discovered VMware virtual machines, and Zabbix will start to monitor them. Note that the discovery and creation of hosts can also be **executed manually**, if necessary.

To view the created hosts, navigate to the *Data collection* → *Hosts* menu section.

Hosts ?

Name ▲	Items	Triggers	Graphs	Discovery	Web	Interface	Proxy	Templates	Status	Availability	Agent encryption	Info	Tags
<input type="checkbox"/> Discover VMware VMs: vm-dobserver-01	Items 40	Triggers 1	Graphs	Discovery 3	Web	vm.example.01:10050		VMware Guest	Enabled	ZBX	None		
<input type="checkbox"/> Discover VMware VMs: vm-dobserver-02	Items 40	Triggers 1	Graphs	Discovery 3	Web	vm.example.02:10050		VMware Guest	Enabled	ZBX	None		
<input type="checkbox"/> VMware VMs	Items	Triggers	Graphs	Discovery 1	Web				Enabled		None		

Displaying 3 of 3 found

0 selected

To view collected metrics, navigate to the *Monitoring* → *Hosts* menu section and click *Latest data* for one of the hosts.

Hosts ? Create host

Name	Interface	Availability	Tags	Status	Latest data	Problems	Graphs	Dashboards	Web
vm-dbserver-01	vm.example.01:10050	ZBX	class: software target: vmware target: vmware-guest	Enabled	Latest data 40	Problems	Graphs	Dashboards	Web
vm-dbserver-02	vm.example.02:10050	ZBX	class: software target: vmware target: vmware-guest	Enabled	Latest data 40	Problems	Graphs	Dashboards	Web
VMware VMs				Enabled	Latest data	Problems	Graphs	Dashboards	Web

Displaying 3 of 3 found

Advanced host interface configuration

The `vmware.vm.discovery[{$VMWARE.URL}]` item key, configured in the *Create a low-level discovery rule* section, returns network interfaces data in the `"net_if"` field:

```
"net_if": [
  {
    "ifname": "5000",
    "ifdesc": "Network adapter 1",
    "ifmac": "00:11:22:33:44:55",
    "ifconnected": true,
    "iftype": "VirtualVmxnet3",
    "ifbackingdevice": "VLAN(myLab)",
    "ifdvswitch_uuid": "",
    "ifdvswitch_portgroup": "",
    "ifdvswitch_port": "",
    "ifip": [
      "127.0.0.1",
      "::1"
    ]
  },
  {
    "ifname": "5001",
    "ifdesc": "Network adapter 2",
    "ifmac": "00:11:22:33:44:55",
    "ifconnected": false,
    "iftype": "VirtualVmxnet3",
    "ifbackingdevice": "VLAN(myLab2)",
    "ifdvswitch_uuid": "",
    "ifdvswitch_portgroup": "",
    "ifdvswitch_port": "",
    "ifip": []
  }
]
```

This data can be used to configure a custom host interface.

1. When *creating a low-level discovery rule*, additionally configure a *low-level discovery macro*. In the *LLD macros* tab, create a custom LLD macro with a *JSONPath* value. For example:

- `{#MYLAB.NET.IF} - $.net_if[?(@.ifbackingdevice=="VLAN(myLab)")].ifip[0].first()`

Discovery rule Preprocessing **LLD macros 1** Filters Overrides

LLD macros	LLD macro	JSONPath	
	{#MYLAB.NET.IF}	\$.net_if[?(@.ifbackingdevice=="VLAN(myLab)")].ifip[0].first()	Remove

[Add](#)

[Add](#) [Test](#) [Cancel](#)

2. When *creating a host prototype*, add a custom host interface and enter the LLD macro in the *DNS name* or *IP address* field.

Host IPMI Tags Macros Inventory Encryption

* Host name {#VM.UUID}

Visible name {#VM.NAME}

Templates VMware Guest X type here to search Select

* Host groups Discovered hosts X type here to search Select

Group prototypes {#MACRO} Remove Add

Interfaces Inherit Custom

Type	IP address	DNS name	Connect to	Port	Default
Agent	{#MYLAB.NET.IF}		IP DNS	10050	<input checked="" type="radio"/> Remove

Add

Monitored by proxy (no proxy)

Create enabled

Discover

Add Cancel

11 Maintenance

Overview You can define maintenance periods for hosts and host groups in Zabbix.

Furthermore, it is possible to define maintenance only for a single trigger (or subset of triggers) by specifying trigger tags. In this case maintenance will be activated only for those triggers; all other triggers of the host or host group will not be in maintenance.

There are two maintenance types - with data collection and with no data collection.

During a maintenance "with data collection" triggers are processed as usual and events are created when required. However, problem escalations are paused for hosts/triggers in maintenance, if the *Pause operations for suppressed problems* option is checked in action configuration. In this case, escalation steps that may include sending notifications or remote commands will be ignored for as long as the maintenance period lasts. Note that problem recovery and update operations are not suppressed during maintenance, only escalations.

For example, if escalation steps are scheduled at 0, 30 and 60 minutes after a problem start, and there is a half-hour long maintenance lasting from 10 minutes to 40 minutes after a real problem arises, steps two and three will be executed a half-hour later, or at 60 minutes and 90 minutes (providing the problem still exists). Similarly, if a problem arises during the maintenance, the escalation will start after the maintenance.

To receive problem notifications during the maintenance normally (without delay), you have to uncheck the *Pause operations for suppressed problems* option in action configuration.

Note:

If at least one host (used in the trigger expression) is not in maintenance mode, Zabbix will send a problem notification.

Zabbix server must be running during maintenance. Maintenances are recalculated every minute or as soon as the configuration cache is reloaded if there are changes to the maintenance period.

Timer processes check if host status must be changed to/from maintenance at 0 seconds of every minute. Additionally, every second the timer process checks if any maintenances must be started/stopped based on whether there are changes to the **maintenance periods** after the configuration update. Thus the speed of starting/stopping maintenance periods depends on the **configuration update interval** (10 seconds by default). Note that maintenance period changes do not include *Active since/Active till* settings. Also, if a host/host group is added to an existing active maintenance period, the changes will only be activated by the timer process at the start of next minute.

Note that when a host enters maintenance, Zabbix server timer processes will read all open problems to check if it is required to suppress those. This may have a performance impact if there are many open problems. Zabbix server will also read all open problems upon startup, even if there are no maintenances configured at the time.

Note that the Zabbix server (or proxy) always collects data regardless of the maintenance type (including "no data" maintenance). The data is later ignored by the server if 'no data collection' is set.

When "no data" maintenance ends, triggers using nodata() function will not fire before the next check during the period they are checking.

If a log item is added while a host is in maintenance and the maintenance ends, only new logfile entries since the end of the maintenance will be gathered.

If a timestamped value is sent for a host that is in a "no data" maintenance type (e.g. using **Zabbix sender**) then this value will be dropped however it is possible to send a timestamped value in for an expired maintenance period and it will be accepted.

If maintenance period, hosts, groups or tags are changed by the user, the changes will only take effect after configuration cache synchronization.

Configuration To configure a maintenance period:

1. Go to: *Data collection* → *Maintenance*.
2. Click on *Create maintenance period* (or on the name of an existing maintenance period).
3. Enter maintenance parameters in the form.

New maintenance period
? X

* Name

Maintenance type With data collection No data collection

* Active since

* Active till

* Periods

Period type	Schedule	Period	Action
Monthly	At 18:00 on day 1 of every January, February, March, April, May, June, July, August, September, October, November, December	1h	Edit Remove

[Add](#)

Host groups Select
type here to search

Hosts Select

* At least one host group or host must be selected.

Tags And/Or Or

Contains
 Equals

[Remove](#)

[Add](#)

Description

All mandatory input fields are marked with a red asterisk.

Parameter	Description
<i>Name</i>	Name of the maintenance period.

Parameter	Description
<i>Maintenance type</i>	Two types of maintenance can be set: With data collection - data will be collected by the server during maintenance, triggers will be processed; No data collection - data will not be collected by the server during maintenance.
<i>Active since</i>	The date and time when executing maintenance periods becomes active. <i>Note:</i> Setting this time alone does not activate a maintenance period; maintenance periods must be configured in <i>Periods</i> (see below).
<i>Active till</i>	The date and time when executing maintenance periods stops being active.
<i>Periods</i>	This block allows you to define the exact days and hours when the maintenance takes place. Clicking on Add opens a popup window with a flexible <i>Maintenance period</i> form where you can define maintenance schedule. See Maintenance periods for a detailed description.
<i>Host groups</i>	Select host groups that the maintenance will be activated for. The maintenance will be activated for all hosts from the specified host group(s). This field is auto-complete, so starting to type in it will display a dropdown of all available host groups. Specifying a parent host group implicitly selects all nested host groups. Thus the maintenance will also be activated on hosts from nested groups.
<i>Hosts</i>	Select hosts that the maintenance will be activated for. This field is auto-complete, so starting to type in it will display a dropdown of all available hosts.
<i>Tags</i>	If maintenance tags are specified, maintenance for the selected hosts will be activated, but only problems with matching tags will be suppressed (that is, no actions will be taken). In case of multiple tags, they are calculated as follows: And/Or - all tags must correspond; however tags with the same tag name are calculated by the Or condition; Or - enough if one tag corresponds. There are two ways of matching the tag value: Contains - case-sensitive substring match (tag value contains the entered string); Equals - case-sensitive string match (tag value equals the entered string). Tags can be specified only if <i>With data collection</i> mode is selected.
<i>Description</i>	Description of maintenance period.

Maintenance periods

The maintenance period window is for scheduling time for a recurring or a one-time maintenance. The form is dynamic with available fields changing based on the *Period type* selected.

New maintenance period ✕

Period type Monthly ▾

* Month January May September
 February June October
 March July November
 April August December

Date Day of month Day of week

* Day of month 1

At (hour:minute) 18 : 00

* Maintenance period length 0 Days 1 ▾ Hours 0 ▾ Minutes

Add Cancel

Period type	Description
<i>One time only</i>	Configure a one time only maintenance period: <i>Date</i> - date and time of the maintenance period; <i>Maintenance period length</i> - for how long the maintenance will be active.
<i>Daily</i>	Configure a daily maintenance period: <i>Every day(s)</i> - maintenance frequency (1 - (<i>default</i>) every day, 2 - every two days, etc.); <i>At (hour:minute)</i> - time of the day when maintenance starts; <i>Maintenance period length</i> - for how long the maintenance will be active. When <i>Every day(s)</i> parameter is greater than "1", the starting day is the day that the <i>Active since</i> time falls on. Examples: - if <i>Active since</i> is set to "2021-01-01 12:00", <i>Every day(s)</i> is set to "2", and <i>At (hour:minute)</i> is set to "23:00", then the first maintenance period will start on January 1 at 23:00, while the second maintenance period will start on January 3 at 23:00; - if <i>Active since</i> is set to "2021-01-01 12:00", <i>Every day(s)</i> is set to "2", and <i>At (hour:minute)</i> is set to "01:00", then the first maintenance period will start on January 3 at 01:00, while the second maintenance period will start on January 5 at 01:00.
<i>Weekly</i>	Configure a weekly maintenance period: <i>Every week(s)</i> - maintenance frequency (1 - (<i>default</i>) every week, 2 - every two weeks, etc.); <i>Day of week</i> - on which day the maintenance should take place; <i>At (hour:minute)</i> - time of the day when maintenance starts; <i>Maintenance period length</i> - for how long the maintenance will be active. When <i>Every week(s)</i> parameter is greater than "1", the starting week is the week that the <i>Active since</i> time falls on. For examples, see parameter <i>Daily</i> description above.
<i>Monthly</i>	Configure a monthly maintenance period: <i>Month</i> - select all months during which the regular maintenance is carried out; <i>Date: Day of month</i> - select this option if the maintenance should take place on the same date each month (for example, every 1st day of the month), and then select the required day in the field <i>Day of month</i> that appears; <i>Date: Day of week</i> - select this option if the maintenance should take place only on certain days (for example, every first Monday of the month), then select (in the drop-down) the required week of the month (first, second, third, fourth, or last), and then mark the checkboxes for maintenance day(s); <i>At (hour:minute)</i> - time of the day when maintenance starts; <i>Maintenance period length</i> - for how long the maintenance will be active.

Attention:

When creating a maintenance period, the **time zone** of the user who creates it is used. However, when recurring maintenance periods (*Daily*, *Weekly*, *Monthly*) are scheduled, the time zone of the Zabbix server is used. To ensure predictable behavior of recurring maintenance periods, it is required to use a common time zone for all parts of Zabbix.

When done, press *Add* to add the maintenance period to the *Periods* block.

Note that Daylight Saving Time (DST) changes do not affect how long the maintenance will be. For example, let's say that we have a two-hour maintenance configured that usually starts at 01:00 and finishes at 03:00:

- if after one hour of maintenance (at 02:00) a DST change happens and current time changes from 02:00 to 03:00, the maintenance will continue for one more hour (till 04:00);
- if after two hours of maintenance (at 03:00) a DST change happens and current time changes from 03:00 to 02:00, the maintenance will stop, because two hours have passed;
- if a maintenance period starts during the hour that is skipped by a DST change, then the maintenance will not start.

If a maintenance period is set to "1 day" (the actual period of the maintenance is 24 hours, since Zabbix calculates days in hours), starts at 00:00 and finishes at 00:00 the next day:

- the maintenance will stop at 01:00 the next day if current time changes forward one hour;
- the maintenance will stop at 23:00 that day if current time changes back one hour.

Display Displaying hosts in maintenance

An orange wrench icon  next to the host name indicates that this host is in maintenance in:

- *Dashboards*
- *Monitoring → Problems*
- *Inventory → Hosts → Host inventory details*
- *Data collection → Hosts* (See 'Status' column)

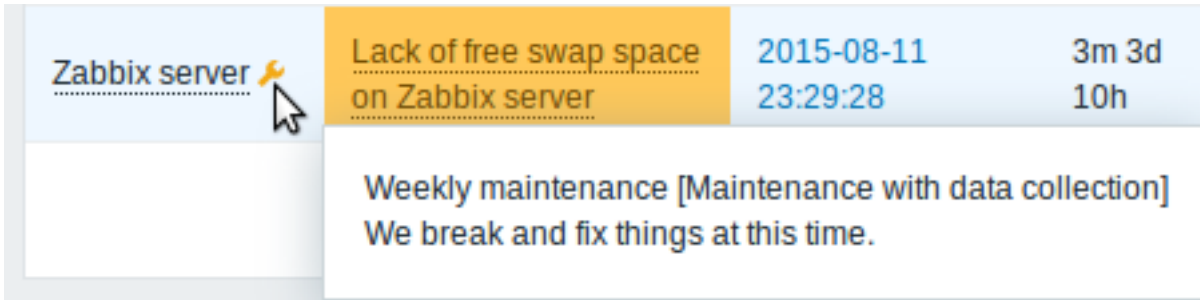

Maintenance details are displayed when the mouse pointer is positioned over the icon.

Additionally, hosts in maintenance get an orange background in *Monitoring → Maps*.

Displaying suppressed problems

Normally problems for hosts in maintenance are suppressed, i.e. not displayed in the frontend. However, it is also possible to configure that suppressed problems are shown, by selecting the *Show suppressed problems* option in these locations:

- *Dashboards* (in *Problem hosts*, *Problems*, *Problems by severity*, *Trigger overview* widget configuration)
- *Monitoring → Problems* (in the filter)
- *Monitoring → Maps* (in map configuration)
- Global **notifications** (in user profile configuration)

When suppressed problems are displayed, the following icon is displayed: . Rolling a mouse over the icon displays more details.

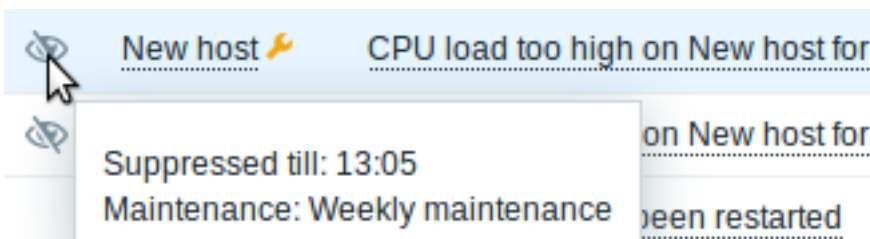

12 Regular expressions

Overview [Perl Compatible Regular Expressions](#) (PCRE, PCRE2) are supported in Zabbix.

There are two ways of using regular expressions in Zabbix:

- manually entering a regular expression
- using a global regular expression created in Zabbix

Regular expressions You may manually enter a regular expression in supported places. Note that the expression may not start with @ because that symbol is used in Zabbix for referencing global regular expressions.

Warning:

It's possible to run out of stack when using regular expressions. See the [pcrestack man page](#) for more information.

Note that in multiline matching, the ^ and \$ anchors match at the beginning/end of each line respectively, instead of the beginning/end of the entire string.

See also examples for **correct escaping** in various contexts.

Global regular expressions There is an advanced editor for creating and testing complex regular expressions in Zabbix frontend.

Once a regular expression has been created this way, it can be used in several places in the frontend by referring to its name, prefixed with @, for example, @mycustomregexp.

To create a global regular expression:

- Go to: *Administration* → *General*
- Select *Regular expressions* from the dropdown
- Click on *New regular expression*

The **Expressions** tab allows to set the regular expression name and add subexpressions.

The screenshot shows the 'Expressions' configuration page in Zabbix. At the top, there are two tabs: 'Expressions' (active) and 'Test'. Below the tabs, there is a form with the following fields:

- * Name:** A text input field containing 'Network interfaces for discovery'.
- * Expressions:** A table with the following columns: 'Expression type', 'Expression', 'Delimiter', and 'Case sensitive'.

Expression type	Expression	Delimiter	Case sensitive
Result is FALSE	^Software Loopback Interface		<input checked="" type="checkbox"/>
Result is FALSE	^(In)?[Ll]oop[Bb]ack[0-9._]*\$		<input checked="" type="checkbox"/>
Result is FALSE	^NULL[0-9.]*\$		<input checked="" type="checkbox"/>
Result is FALSE	^[Ll]o[0-9.]*\$		<input checked="" type="checkbox"/>
Result is FALSE	^[Ss]ystem\$		<input checked="" type="checkbox"/>
Result is FALSE	^Nu[0-9.]*\$		<input checked="" type="checkbox"/>
- Add:** A blue link at the bottom left of the Expressions table.

All mandatory input fields are marked with a red asterisk.

Parameter	Description
<i>Name</i>	Set the regular expression name. Any Unicode characters are allowed.
<i>Expressions</i>	Click on <i>Add</i> in the Expressions block to add a new subexpression.
<i>Expression type</i>	Select expression type: Character string included - match the substring Any character string included - match any substring from a delimited list. The delimited list includes a comma (,), a dot (.) or a forward slash (/). Character string not included - match any string except the substring Result is TRUE - match the regular expression Result is FALSE - do not match the regular expression
<i>Expression</i>	Enter substring/regular expression.
<i>Delimiter</i>	A comma (,), a dot (.) or a forward slash (/) to separate text strings in a regular expression. This parameter is active only when "Any character string included" expression type is selected.
<i>Case sensitive</i>	A checkbox to specify whether a regular expression is sensitive to capitalization of letters.

A forward slash (/) in the expression is treated literally, rather than a delimiter. This way it is possible to save expressions containing a slash, without errors.

Attention:

A custom regular expression name in Zabbix may contain commas, spaces, etc. In those cases where that may lead to misinterpretation when referencing (for example, a comma in the parameter of an item key) the whole reference may be put in quotes like this: "@My custom regexp for purpose1, purpose2".

Regular expression names must not be quoted in other locations (for example, in LLD rule properties).

In the **Test** tab the regular expression and its subexpressions can be tested by providing a test string.

Expressions
Test

Test string

Test expressions

	Expression type	Expression	Result
Result	Result is FALSE	^Software Loopback Interface	TRUE
	Result is FALSE	^(In)?[Ll]oop[Bb]ack[0-9._]*\$	TRUE
	Result is FALSE	^NULL[0-9.]*\$	TRUE
	Result is FALSE	^[Ll]o[0-9.]*\$	FALSE
	Result is FALSE	^[Ss]ystem\$	TRUE
	Result is FALSE	^Nu[0-9.]*\$	TRUE
	Combined result		FALSE

Results show the status of each subexpression and total custom expression status.

Total custom expression status is defined as *Combined result*. If several sub expressions are defined Zabbix uses AND logical operator to calculate *Combined result*. It means that if at least one Result is False *Combined result* has also False status.

Default global regular expressions Zabbix comes with several global regular expression in its default dataset.

Name	Expression	Matches
File systems for discovery	^(btrfs ext2 ext3 ext4 jfs reiser xfs ffs ufs gfs2 vxfs hfs refs apfs ntfs fat32 zfs)	"reiser" or "xfs" or "ffs" or "ufs" or "jfs" or "jfs2" or "vxfs" or "hfs" or "refs" or "apfs" or "ntfs" or "fat32" or "zfs"
Network interfaces for discovery	^Software Loopback Interface	Strings starting with "Software Loopback Interface".
	^lo\$	"lo"
	^(In)?[Ll]oop[Bb]ack[0-9._]*\$	Strings that optionally start with "In", then have "L" or "l", then "oop", then "B" or "b", then "ack", which can be optionally followed by any number of digits, dots or underscores.
	^NULL[0-9.]*\$	Strings starting with "NULL" optionally followed by any number of digits or dots.
	^[Ll]o[0-9.]*\$	Strings starting with "Lo" or "lo" and optionally followed by any number of digits or dots.
Storage devices for SNMP discovery	^[Ss]ystem\$	"System" or "system"
	^Nu[0-9.]*\$	Strings starting with "Nu" optionally followed by any number of digits or dots.
Windows service names for discovery	^(Physical memory Virtual memory Memory buffers Cached memory Swap space)\$	"Physical memory" or "Virtual memory" or "Memory buffers" or "Cached memory" or "Swap space"
	^(MMCSS gupdate SysmonLog clr_optimization_v2.0.50727_32 MMCSS.50727_32 clr_optimization_v4.0.30319_32)	like "clr_optimization_v2.0.50727_32" and "clr_optimization_v4.0.30319_32" where instead of dots you can put any character except newline.

Name	Expression	Matches
Windows service startup states for discovery	^(automatic automatic delayed)\$	"automatic" or "automatic delayed"

Examples Example 1

Use of the following expression in low-level discovery to discover databases except a database with a specific name:

`^TESTDATABASE$`

Test string

Test expressions

Result	Expression type	Expression	Result
	Result is FALSE	<code>^TESTDATABASE</code>	FALSE
	Combined result		FALSE

Chosen *Expression type*: "Result is FALSE". Doesn't match name, containing string "TESTDATABASE".

Example with an inline regex modifier

Use of the following regular expression including an inline modifier (?i) to match the characters "error":

`(?i)error`

Test string

Test expressions

Result	Expression type	Expression	Result
	Result is TRUE	<code>(?i)error</code>	TRUE
	Combined result		TRUE

Chosen *Expression type*: "Result is TRUE". Characters "error" are matched.

Another example with an inline regex modifier

Use of the following regular expression including multiple inline modifiers to match the characters after a specific line:

`(?<=match (?i)everything(?-i) after this line\n)(?sx).*#` we add s modifier to allow . match newline character

Test string

```
Some text here for your consideration
1235kfd345
match eveRything after this line
Continuation
```

Test expressions

Result	Expression type	Expression	Result
	Result is TRUE	(?<=match (?i)everything(?-i) after this line\n)(?sx).*# we add s modifier to allow . match newline characters	TRUE
	Combined result		TRUE

Chosen Expression type: "Result is TRUE". Characters after a specific line are matched.

Attention:

g modifier can't be specified in line. The list of available modifiers can be found in [pcresyntax man page](#). For more information about PCRE syntax please refer to [PCRE HTML documentation](#).

Regular expression support by location

Location	Regular expression	Global regular expression	Multiline matching	Comments
Agent items				
eventlog[]	Yes	Yes	Yes	regexp, severity, source, eventid parameters
eventlog.count[]				regexp, severity, source, eventid parameters
log[]				regexp parameter
log.count[]				
logrt[]		Yes/No		regexp parameter supports both, file_regexp parameter supports non-global expressions only
logrt.count[]				
proc.cpu.util[]		No	No	cmdline parameter
proc.get[]				
proc.mem[]				
proc.num[]				
sensor[]				device and sensor parameters on Linux 2.4
system.hw.macaddr[]				interface parameter
system.sw.packages[]				regexp parameter
system.sw.packages.get[]				regexp parameter
vfs.dir.count[]				regex_incl, regex_excl, regex_excl_dir parameters
vfs.dir.get[]				regex_incl, regex_excl, regex_excl_dir parameters
vfs.dir.size[]				regex_incl, regex_excl, regex_excl_dir parameters
vfs.file.regexp[]			Yes	regexp parameter
vfs.file.regmatch[]				
web.page.regexp[]				
SNMP traps				
snmptrap[]	Yes	Yes	No	regexp parameter
Item value pre-processing	Yes	No	No	pattern parameter

Location	Regular expression	Global regular expression	Multiline matching	Comments
Functions for triggers/calculated items				
count()	Yes	Yes	Yes	pattern parameter if operator parameter is <i>regex</i> or <i>iregexp</i>
countunique()	Yes	Yes		
find()	Yes	Yes		
logeventid()	Yes	Yes	No	pattern parameter
logsource()				
Low-level discovery				
Filters	Yes	Yes	No	<i>Regular expression</i> field
Overrides	Yes	No		In <i>matches</i> , does not match options for <i>Operation</i> conditions
Action conditions	Yes	No	No	In <i>matches</i> , does not match options for <i>Host name</i> and <i>Host metadata</i> autoregistration conditions
Scripts	Yes	Yes	No	<i>Input validation rule</i> field
Web monitoring	Yes	No	Yes	<i>Variables</i> with a regex: prefix <i>Required string</i> field
User macro context	Yes	No	No	In macro context with a regex: prefix
Macro functions				
regsub()	Yes	No	No	pattern parameter
iregsub()				
Icon mapping	Yes	Yes	No	<i>Expression</i> field
Value mapping	Yes	No	No	<i>Value</i> field if mapping type is <i>regex</i>

13 Problem acknowledgment

Overview Problem events in Zabbix can be acknowledged by users.

If a user gets notified about a problem event, they can go to Zabbix frontend, open the problem update popup window of that problem using one of the ways listed below and acknowledge the problem. When acknowledging, they can enter their comment for it, saying that they are working on it or whatever else they may feel like saying about it.

This way, if another system user spots the same problem, they immediately see if it has been acknowledged and the comments so far.

This way the workflow of resolving problems with more than one system user can take place in a coordinated way.

Acknowledgment status is also used when defining **action operations**. You can define, for example, that a notification is sent to a higher level manager only if an event is not acknowledged for some time.

To acknowledge events and comment on them, a user must have at least read permissions to the corresponding triggers. To change problem severity or close problem, a user must have read-write permissions to the corresponding triggers.

There are **several** ways to access the problem update popup window, which allows acknowledging a problem.

- You may select problems in *Monitoring → Problems* and then click on *Mass update* below the list
- You can click on *Update* in the *Update* column of a problem in:
 - *Dashboards (Problems and Problems by severity widgets)*
 - *Monitoring → Problems*
 - *Monitoring → Problems → Event details*
- You can click on an unresolved problem cell in:
 - *Dashboards (Trigger overview widget)*

The popup menu contains an *Update* option that will take you to the problem update window.

Updating problems The problem update popup allows to:

- comment on the problem
- view comments and actions so far
- change problem severity
- suppress/unsuppress problem
- acknowledge/unacknowledge problem
- change symptom problem to cause problem
- manually close problem

Update problem ? X

Problem */:* Disk space is critically low (used > 90%)

Message

History	Time	User	User action	Message
	2022-06-10 11:49:04	Admin (Zabbix Administrator)		
	2022-06-10 11:25:16	Admin (Zabbix Administrator)		
	2022-06-10 11:06:13	Admin (Zabbix Administrator)		
	2022-06-09 19:17:21	Admin (Zabbix Administrator)		
	2022-06-09 13:15:15	Admin (Zabbix Administrator)		
	2022-06-09 13:12:13	Admin (Zabbix Administrator)		
	2022-06-09 13:12:02	Admin (Zabbix Administrator)		

Scope

Only selected problem

Selected and all other problems of related triggers 1 event

Change severity

Suppress

Unsuppress

Acknowledge

Convert to cause

Close problem

* At least one update operation or message must exist.

All mandatory input fields are marked with a red asterisk.

Parameter	Description
<i>Problem</i>	If only one problem is selected, the problem name is displayed. If several problems are selected, <i>N problems selected</i> is displayed.
<i>Message</i>	Enter text to comment on the problem (maximum 2048 characters).
<i>History</i>	Previous activities and comments on the problem are listed, along with the time and user details. For the meaning of icons used to denote user actions see the event detail page.
<i>Scope</i>	Note that history is displayed if only one problem is selected for the update. Define the scope of such actions as changing severity, acknowledging or manually closing problems: Only selected problem - will affect this event only Selected and all other problems of related triggers - in case of acknowledgment/closing problem, will affect this event and all other problems that are not acknowledged/closed so far. If the scope contains problems already acknowledged or closed, these problems will not be acknowledged/closed repeatedly. On the other hand, the number of message and severity change operations are not limited.
<i>Change severity</i>	Mark the checkbox and click on the severity button to update problem severity. The checkbox for changing severity is available if read-write permissions exist for at least one of the selected problems. Only those problems that are read-writable will be updated when clicking on <i>Update</i> . If read-write permissions exist for none of the selected triggers, the checkbox is disabled.

Parameter	Description
<i>Suppress</i>	<p>Mark the checkbox to suppress the problem:</p> <p>Indefinitely - suppress indefinitely</p> <p>Until - suppress until a given time. Both absolute and relative time formats are supported, for example:</p> <p><code>now+1d</code> - for one day from now (default)</p> <p><code>now/w</code> - until the end of the current week</p> <p><code>2022-05-28 12:00:00</code> - until absolute date/time</p> <p>Note that a simple period (e. g., 1d, 1w) is not supported.</p> <p>Availability of this option depends on the "Suppress problems" user role settings.</p> <p>See also: Problem suppression</p>
<i>Unsuppress</i>	<p>Mark the checkbox to unsuppress the problem. This checkbox is active only if at least one of the selected problems is suppressed.</p> <p>Availability of this option depends on the "Suppress problems" user role settings.</p>
<i>Acknowledge</i>	<p>Mark the checkbox to acknowledge the problem.</p> <p>This checkbox is available if there is at least one unacknowledged problem among the selected. It is not possible to add another acknowledgment for an already acknowledged problem (it is possible to add another comment though).</p>
<i>Unacknowledge</i>	<p>Mark the checkbox to unacknowledge the problem.</p> <p>This checkbox is available if there is at least one acknowledged problem among the selected.</p>
<i>Convert to cause</i>	<p>Mark the checkbox to convert the symptom problem(s) to cause problem(s).</p>
<i>Close problem</i>	<p>Mark the checkbox to manually close the selected problem(s).</p> <p>The checkbox for closing a problem is available if the <i>Allow manual close</i> option is checked in trigger configuration for at least one of the selected problems. Only those problems will be closed that are allowed to be closed when clicking on <i>Update</i>.</p> <p>If no problem is manually closeable, the checkbox is disabled.</p> <p>Already closed problems will not be closed repeatedly.</p>

Display Based on acknowledgment information it is possible to configure how the problem count is displayed in the dashboard or maps. To do that, you have to make selections in the *Problem display* option, available in both [map configuration](#) and the *Problems by severity dashboard widget*. It is possible to display all problem count, unacknowledged problem count as separated from the total or unacknowledged problem count only.

Based on problem update information (acknowledgment, etc.), it is possible to configure update operations - send a message or execute remote commands.

1 Problem suppression

Overview

Problem suppression offers a way of temporarily hiding a problem that can be dealt with later. This is useful for cleaning up the problem list in order to give the highest priority to the most urgent issues. For example, sometimes an issue may arise on the weekend that is not urgent enough to be dealt with immediately, so it can be "snoozed" until Monday morning.

Problem suppression allows to hide a *single* problem, in contrast to problem suppression through host maintenance when all problems of the maintenance host are hidden.

Operations for trigger actions will be paused for suppressed problems the same way as it is done with [host maintenance](#).

Configuration

A problem can be suppressed through the **problem update** window, where suppression is one of the problem update options along with commenting, changing severity, acknowledging, etc.

A problem may also be unsuppressed through the same problem update window.

Display

Once suppressed the problem is marked by a blinking  suppression icon in the *Info* column, before being hidden.

The suppression icon is blinking while the suppression task is in the waiting list. Once the task manager has suppressed the problem, the icon will stop blinking. If the suppression icon keeps blinking for a long time, this may indicate a server problem, for example, if the server is down and the task manager cannot complete the task. The same logic applies to unsuppression. In the short period after the task is submitted and the server has not completed it, the unsuppression icon is blinking.

A suppressed problem may be both hidden or shown, depending on the problem filter/widget settings.

When shown in the problem list, a suppressed problem is marked by the suppression icon and suppression details are shown on mouseover:

Time	Info	Host	Problem + Severity	Duration	Ack	Actions
2022-06-09 13:11:16		Zabbix	/: Disk space is critically low (used > 90%)	22h 38m 14s	No	
2022-06-09 11:56:31				23h 52m 59s	No	

Suppression details are also displayed in a popup when positioning the mouse on the suppression icon in the *Actions* column.

14 Configuration export/import

Overview Zabbix export/import functionality makes it possible to exchange various configuration entities between one Zabbix system and another.

Typical use cases for this functionality:

- share templates or network maps - Zabbix users may share their configuration parameters
- upload a template to [Zabbix Community templates](#). Then others can download the template and import the file into Zabbix.
- integrate with third-party tools - universal YAML, XML and JSON formats make integration and data import/export possible with third-party tools and applications

What can be exported/imported

Objects that can be exported/imported are:

- **Host groups** (through Zabbix API only)
- **Template groups** (through Zabbix API only)
- **Templates**
- **Hosts**
- **Network maps**
- **Media types**
- **Images**

Export format

Data can be exported using the Zabbix web frontend or [Zabbix API](#). Supported export formats are YAML, XML and JSON.

Details about export

- All supported elements are exported in one file.
- Host and template entities (items, triggers, graphs, discovery rules) that are inherited from linked templates are not exported. Any changes made to those entities on a host level (such as changed item interval, modified regular expression or added prototypes to the low-level discovery rule) will be lost when exporting; when importing, all entities from linked templates are re-created as on the original linked template.
- Entities created by low-level discovery and any entities depending on them are not exported. For example, a trigger created for an LLD-rule generated item will not be exported.
- When the exported host/template contains entities supporting timeouts, the timeout values will be exported if these entities have their own timeouts configured.

Details about import

- Import stops at the first error.
- When updating existing images during image import, "imagetype" field is ignored, i.e., it is impossible to change image type via import.

- When importing hosts/templates using the "Delete missing" option, host/template macros not present in the import file will be deleted from the host/template after the import.
- Empty tags for items, triggers, graphs, discoveryRules, itemPrototypes, triggerPrototypes, graphPrototypes are meaningless, i.e., it's the same as if it was missing.
- If entities of the imported host/template have their own timeouts configured, they will be applied; otherwise, proxy/global timeouts will be applied.
- Import supports YAML, XML and JSON, the import file must have a correct file extension: .yaml and .yml for YAML, .xml for XML and .json for JSON. See [compatibility information](#) about supported XML versions.
- Import supports configuration files only in UTF-8 encoding (with or without BOM); other encodings (UTF16LE, UTF16BE, UTF32LE, UTF32BE, etc.) will result in an import conversion error.

YAML base format The YAML export format contains the following nodes:

- Root node for Zabbix YAML export
- Export version

```
zabbix_export:
  version: '7.4'
```

Other nodes are dependent on exported objects.

XML format The XML export format contains the following tags:

- Default header for XML documents
- Root tag for Zabbix XML export
- Export version

```
<?xml version="1.0" encoding="UTF-8"?>
<zabbix_export>
  <version>7.4</version>
</zabbix_export>
```

Other tags are dependent on exported objects.

JSON format The JSON export format contains the following objects:

- Root object for Zabbix JSON export
- Export version

```
{
  "zabbix_export": {
    "version": "7.4"
  }
}
```

Other objects are dependent on exported objects.

1 Template groups

Overview

In the frontend, template groups can be **exported** only with template export. When a template is exported, all groups it belongs to are exported with it automatically.

API allows exporting template groups independently of templates.

Export format

```
template_groups:
- uuid: 36bff6c29af64692839d077febf7079
  name: 'Network devices'
```

Exported elements

Element	Type	Description
uuid	string	Unique identifier for this template group.
name	string	Group name.

2 Host groups

Overview

In the frontend, host groups can be **exported** only with host export. When a host is exported, all groups it belongs to are exported with it automatically.

API allows exporting host groups independently of hosts.

Export format

```
host_groups:
- uuid: 6f6799aa69e844b4b3918f779f2abf08
  name: 'Zabbix servers'
```

Exported elements

Element	Type	Description
uuid	string	Unique identifier for this host group.
name	string	Group name.

3 Templates

Overview

Templates are **exported** with many related objects and object relations.

Template export contains:

- Linked template groups
- Linked host groups (if used in **host prototype** configuration)
- Template data
- Linkage to other templates
- Linkage to template groups
- Directly linked items
- Directly linked triggers
- Directly linked graphs
- Directly linked dashboards
- Directly linked discovery rules with all prototypes
- Directly linked web scenarios
- Value maps

Exporting

To export templates, do the following:

1. Go to *Data collection* → *Templates*.
2. Mark the checkboxes of the templates to export.
3. Click *Export* below the list.

≡ Templates

The screenshot shows the Zabbix Templates management interface. At the top, there is a header with a hamburger menu icon and the title 'Templates'. Below this is a table with two columns: 'Name' and 'Hosts'. The first row is 'Template DB MySQL' with 'Hosts' listed, and it is highlighted in yellow. Below the table, there is a status bar that says '1 selected'. To the right of the status bar are several action buttons: 'Export', 'Mass update', and 'Delete'. The 'Export' button is currently selected, and a dropdown menu is open below it, showing three options: 'YAML', 'XML', and 'JSON'.

Depending on the selected format, templates are exported to a local file with a default name:

- `zabbix_export_templates.yaml` - in YAML export (default option for export);
- `zabbix_export_templates.xml` - in XML export;
- `zabbix_export_templates.json` - in JSON export.

Importing

To import templates, do the following:

1. Go to *Data collection* → *Templates*.
2. Click *Import* in the top right corner.
3. Select the import file.
4. Click *Import* in the bottom right corner of the configuration form.

Import ? X

* Import file Browse... apc_ups_snmp.yaml

Advanced options

Rules	Update existing	Create new	Delete missing
All	<input checked="" type="checkbox"/>	<input checked="" type="checkbox"/>	<input checked="" type="checkbox"/>
Template groups	<input checked="" type="checkbox"/>	<input checked="" type="checkbox"/>	
Host groups	<input checked="" type="checkbox"/>	<input checked="" type="checkbox"/>	
Templates	<input checked="" type="checkbox"/>	<input checked="" type="checkbox"/>	
Value mappings	<input checked="" type="checkbox"/>	<input checked="" type="checkbox"/>	<input checked="" type="checkbox"/>
Template dashboards	<input checked="" type="checkbox"/>	<input checked="" type="checkbox"/>	<input checked="" type="checkbox"/>
Template linkage		<input checked="" type="checkbox"/>	<input checked="" type="checkbox"/>
Items	<input checked="" type="checkbox"/>	<input checked="" type="checkbox"/>	<input checked="" type="checkbox"/>
Discovery rules	<input checked="" type="checkbox"/>	<input checked="" type="checkbox"/>	<input checked="" type="checkbox"/>
Triggers	<input checked="" type="checkbox"/>	<input checked="" type="checkbox"/>	<input checked="" type="checkbox"/>
Graphs	<input checked="" type="checkbox"/>	<input checked="" type="checkbox"/>	<input checked="" type="checkbox"/>
Web scenarios	<input checked="" type="checkbox"/>	<input checked="" type="checkbox"/>	<input checked="" type="checkbox"/>

Import
Cancel

If you mark the *Advanced options* checkbox, a detailed list of all importable elements will be displayed - mark or unmark each import rule as required.

If you click the checkbox in the *All* row, all elements below it will be marked/unmarked.

Import rules:

Rule	Description
<i>Update existing</i>	Existing elements will be updated using data from the import file. Otherwise, they will not be updated.
<i>Create new</i>	New elements will be created using data from the import file. Otherwise, they will not be created.
<i>Delete missing</i>	Existing elements not present in the import file will be removed. Otherwise, they will not be removed. If <i>Delete missing</i> is marked for <i>Template linkage</i> , current template linkage not present in the import file will be unlinked. Entities (items, triggers, graphs, etc.) inherited from the unlinked templates will not be removed (unless the <i>Delete missing</i> option is selected for each entity as well).

On the next screen, you will be able to view the content of a template being imported. If this is a new template, all elements will be listed in green. If updating an existing template, new template elements will be highlighted in green; removed template elements will be highlighted in red; elements that have not changed will be listed on a gray background.

Templates

The screenshot shows the Zabbix Templates interface. On the left, a navigation menu is visible with sections for 'Updated' and 'Templates'. Under 'Updated', there is a sub-section for 'VMware'. On the right, a YAML configuration snippet is displayed, showing the structure of a template. The snippet includes fields for 'name', 'description', 'groups', 'tags', and 'macros'. The 'name' field is highlighted in red, and the 'description' field is highlighted in green. The 'groups' field is set to 'Templates/Applications'. The 'tags' field includes 'class' (software) and 'target' (vmware). The 'macros' field includes three macros: '\$VMWARE.PASSWORD', '\$VMWARE.URL', and '\$VMWARE.USERNAME'.

```
templates:
  template: VMware
- name: VMware
+ name: 'VMware alternative'
- description: "You can discuss this template or leave feedback on our forum"
+ description: "You can discuss this fabulous template or leave feedback on our forum"
  groups:
    - name: Templates/Applications
  tags:
    - tag: class
      value: software
    - tag: target
      value: vmware
  macros:
    - macro: '{$VMWARE.PASSWORD}'
      description: 'VMware service {USERNAME} user password'
    - macro: '{$VMWARE.URL}'
      description: 'VMware service (vCenter or ESX hypervisor) SDK URL (https://www.zabbix.com/forum/zabbix-s)'
    - macro: '{$VMWARE.USERNAME}'
      description: 'VMware service user name'
```

The menu on the left can be used to navigate through the list of changes. The *Updated* section highlights all changes made to existing template elements. The *Added* section lists new template elements. The elements in each section are grouped by element type; click the gray arrow to expand or collapse the group of elements.

The screenshot shows the Zabbix Templates interface. On the left, a navigation menu is visible with sections for 'Updated' and 'Templates'. Under 'Updated', there is a sub-section for 'APC UPS SNMP'. Under 'Added', there is a sub-section for 'Items'. On the right, a YAML configuration snippet is displayed, showing the structure of a template. The snippet includes fields for 'name', 'description', 'groups', 'tags', and 'macros'. The 'name' field is highlighted in red, and the 'description' field is highlighted in green. The 'groups' field is set to 'Templates/Applications'. The 'tags' field includes 'class' (software) and 'target' (vmware). The 'macros' field includes three macros: '\$VMWARE.PASSWORD', '\$VMWARE.URL', and '\$VMWARE.USERNAME'.

Review template changes and then click *Import* to perform the template import. A success or failure message of the import will be displayed in the frontend.

Export format

Export format in YAML:

```
zabbix_export:
  version: '7.2'
  template_groups:
    - uuid: a571c0d144b14fd4a87a9d9b2aa9fcd6
      name: Templates/Applications
  host_groups:
    - uuid: a571c0d144b14fd4a87a9d9b2aa9fcd6
      name: Applications
  templates:
    - uuid: 56079badd056419383cc26e6a4fcc7e0
      template: VMware
      name: VMware
      description: |
        You can discuss this template or leave feedback on our forum https://www.zabbix.com/forum/zabbix-s
```

```

Template tooling version used: 0.41
groups:
- name: Templates/Applications
items:
- uuid: 5ce209f4d94f460488a74a92a52d92b1
  name: 'VMware: Event log'
  type: SIMPLE
  key: 'vmware.eventlog[{$VMWARE.URL},skip]'
  history: 7d
  trends: '0'
  value_type: LOG
  username: '{$VMWARE.USERNAME}'
  password: '{$VMWARE.PASSWORD}'
  description: 'Collect VMware event log.'
  tags:
    - tag: component
      value: log
- uuid: ee2edad8ce943ef81d25dbbba8667a4
  name: 'VMware: Full name'
  type: SIMPLE
  key: 'vmware.fullname[{$VMWARE.URL}]'
  delay: 1h
  history: 7d
  trends: '0'
  value_type: CHAR
  username: '{$VMWARE.USERNAME}'
  password: '{$VMWARE.PASSWORD}'
  description: 'VMware service full name.'
  preprocessing:
    - type: DISCARD_UNCHANGED_HEARTBEAT
      parameters:
        - 1d
  tags:
    - tag: component
      value: system
- uuid: a0ec9145f2234fba79a28c57ebdb44d
  name: 'VMware: Version'
  type: SIMPLE
  key: 'vmware.version[{$VMWARE.URL}]'
  delay: 1h
  history: 7d
  trends: '0'
  value_type: CHAR
  username: '{$VMWARE.USERNAME}'
  password: '{$VMWARE.PASSWORD}'
  description: 'VMware service version.'
  preprocessing:
    - type: DISCARD_UNCHANGED_HEARTBEAT
      parameters:
        - 1d
  tags:
    - tag: component
      value: system
discovery_rules:
- uuid: 16ffc933cce74cf28a6edf306aa99782
  name: 'Discover VMware clusters'
  type: SIMPLE
  key: 'vmware.cluster.discovery[{$VMWARE.URL}]'
  delay: 1h
  username: '{$VMWARE.USERNAME}'
  password: '{$VMWARE.PASSWORD}'
  description: 'Discovery of clusters'

```

```

item_prototypes:
- uuid: 46111f91dd564a459dbc1d396e2e6c76
  name: 'VMware: Status of "{#CLUSTER.NAME}" cluster'
  type: SIMPLE
  key: 'vmware.cluster.status[{$VMWARE.URL},{#CLUSTER.NAME}]'
  history: 7d
  username: '{$VMWARE.USERNAME}'
  password: '{$VMWARE.PASSWORD}'
  description: 'VMware cluster status.'
  valuemap:
    name: 'VMware status'
  tags:
    - tag: cluster
      value: '{#CLUSTER.NAME}'
    - tag: component
      value: cluster
- uuid: 8fb6a45cbe074b0cb6df53758e2c6623
  name: 'Discover VMware datastores'
  type: SIMPLE
  key: 'vmware.datastore.discovery[{$VMWARE.URL}]'
  delay: 1h
  username: '{$VMWARE.USERNAME}'
  password: '{$VMWARE.PASSWORD}'
item_prototypes:
- uuid: 4b61838ba4c34e709b25081ae5b059b5
  name: 'VMware: Average read latency of the datastore {#DATASTORE}'
  type: SIMPLE
  key: 'vmware.datastore.read[{$VMWARE.URL},{#DATASTORE},latency]'
  history: 7d
  username: '{$VMWARE.USERNAME}'
  password: '{$VMWARE.PASSWORD}'
  description: 'Amount of time for a read operation from the datastore (milliseconds).'
  tags:
    - tag: component
      value: datastore
    - tag: datastore
      value: '{#DATASTORE}'
- uuid: 5355c401dc244bc588ccd18767577c93
  name: 'VMware: Free space on datastore {#DATASTORE} (percentage)'
  type: SIMPLE
  key: 'vmware.datastore.size[{$VMWARE.URL},{#DATASTORE},pfree]'
  delay: 5m
  history: 7d
  value_type: FLOAT
  units: '%'
  username: '{$VMWARE.USERNAME}'
  password: '{$VMWARE.PASSWORD}'
  description: 'VMware datastore space in percentage from total.'
  tags:
    - tag: component
      value: datastore
    - tag: datastore
      value: '{#DATASTORE}'
- uuid: 84f13c4fde2d4a17baaf0c8c1eb4f2c0
  name: 'VMware: Total size of datastore {#DATASTORE}'
  type: SIMPLE
  key: 'vmware.datastore.size[{$VMWARE.URL},{#DATASTORE}]'
  delay: 5m
  history: 7d
  units: B
  username: '{$VMWARE.USERNAME}'
  password: '{$VMWARE.PASSWORD}'

```

```

description: 'VMware datastore space in bytes.'
tags:
  - tag: component
    value: datastore
  - tag: datastore
    value: '#{DATASTORE}'
- uuid: 540cd0fbc56c4b8ea19f2ff5839ce00d
  name: 'VMware: Average write latency of the datastore {#DATASTORE}'
  type: SIMPLE
  key: 'vmware.datastore.write[{$VMWARE.URL},{#DATASTORE},latency]'
  history: 7d
  username: '{$VMWARE.USERNAME}'
  password: '{$VMWARE.PASSWORD}'
  description: 'Amount of time for a write operation to the datastore (milliseconds).'
  tags:
    - tag: component
      value: datastore
    - tag: datastore
      value: '#{DATASTORE}'
- uuid: a5bc075e89f248e7b411d8f960897a08
  name: 'Discover VMware hypervisors'
  type: SIMPLE
  key: 'vmware.hv.discovery[{$VMWARE.URL}]'
  delay: 1h
  username: '{$VMWARE.USERNAME}'
  password: '{$VMWARE.PASSWORD}'
  description: 'Discovery of hypervisors.'
  host_prototypes:
    - uuid: 051a1469d4d045cbbf818fcc843a352e
      host: '#{HV.UUID}'
      name: '#{HV.NAME}'
      group_links:
        - group:
            name: Applications
      group_prototypes:
        - name: '#{CLUSTER.NAME}'
        - name: '#{DATACENTER.NAME}'
      templates:
        - name: 'VMware Hypervisor'
      macros:
        - macro: '{$VMWARE.HV.UUID}'
          value: '#{HV.UUID}'
          description: 'UUID of hypervisor.'
      custom_interfaces: 'YES'
      interfaces:
        - ip: '#{HV.IP}'
- uuid: 9fd559f4e88c4677a1b874634dd686f5
  name: 'Discover VMware VMs'
  type: SIMPLE
  key: 'vmware.vm.discovery[{$VMWARE.URL}]'
  delay: 1h
  username: '{$VMWARE.USERNAME}'
  password: '{$VMWARE.PASSWORD}'
  description: 'Discovery of guest virtual machines.'
  host_prototypes:
    - uuid: 23b9ae9d6f33414880db1cb107115810
      host: '#{VM.UUID}'
      name: '#{VM.NAME}'
      group_links:
        - group:
            name: Applications
      group_prototypes:

```

```

    - name: '#{CLUSTER.NAME} (vm)'
    - name: '#{DATACENTER.NAME}/#{VM.FOLDER} (vm)'
    - name: '#{HV.NAME}'
  templates:
    - name: 'VMware Guest'
  macros:
    - macro: '{$VMWARE.VM.UUID}'
      value: '#{VM.UUID}'
      description: 'UUID of guest virtual machine.'
  custom_interfaces: 'YES'
  interfaces:
    - ip: '#{VM.IP}'
tags:
  - tag: class
    value: software
  - tag: target
    value: vmware
macros:
  - macro: '{$VMWARE.PASSWORD}'
    description: 'VMware service {$USERNAME} user password'
  - macro: '{$VMWARE.URL}'
    description: 'VMware service (vCenter or ESX hypervisor) SDK URL (https://servername/sdk)'
  - macro: '{$VMWARE.USERNAME}'
    description: 'VMware service user name'
valuemaps:
  - uuid: 3c59c22905054d42ac4ee8b72fe5f270
    name: 'VMware status'
    mappings:
      - value: '0'
        newvalue: gray
      - value: '1'
        newvalue: green
      - value: '2'
        newvalue: yellow
      - value: '3'
        newvalue: red

```

Exported elements Exported elements are explained in the tables below.

Element	Type	Description
template_groups		(required) Root element for template groups.
uuid	string	(required) Unique identifier for this template group.
name	string	(required) Template group name.
host_groups		(required) Root element for host groups that are used by host prototypes.
uuid	string	(required) Unique identifier for this host group.
name	string	(required) Host group name.
templates		Root element for templates .

Templates

Element	Type	Description
uuid	string	(required) Unique identifier for this template.
template	string	(required) Unique template name.
name	string	Visible template name.
description	text	Template description.
vendor		Root element for template vendor (present if the exported template contains vendor data).
name	string	(required) Template vendor name.

Element	Type	Description
version	string	(required) Template version. For out-of-the-box templates , version is displayed as follows: major version of Zabbix, delimiter ("-"), revision number (increased with each new version of the template, and reset with each major version of Zabbix). For example, 7.0-0, 7.0-3, 7.2-0, 7.2-3.
templates		Root element for linked templates.
name	string	(required) Template name.
groups		Root element for template groups.
name	string	(required) Template group name.
items		Root element for template items .
discovery_rules		Root element for template low-level discovery rules .
httptests		Root element for template web scenarios .
tags		Root element for template tags.
tag	string	(required) Tag name.
value	string	Tag value.
macros		Root element for template user macros.
macro	string	(required) User macro name.
type	string	User macro type. Possible values: ¹ TEXT (0, default), SECRET_TEXT (1), VAULT (2). See also: User macro object (type).
value	string	User macro value.
description	string	User macro description.
dashboards		Root element for template dashboards .
valuemaps		Root element for template value maps .

Template items

Element	Type	Description
uuid	string	(required) Unique identifier for this item.
name	string	(required) Item name.
type	string	Item type. Possible values: ¹ ZABBIX_PASSIVE (0, default), TRAP (2), SIMPLE (3), INTERNAL (5), ZABBIX_ACTIVE (7), EXTERNAL (10), ODBC (11), IPMI (12), SSH (13), TELNET (14), CALCULATED (15), JMX (16), SNMP_TRAP (17), DEPENDENT (18), HTTP_AGENT (19), SNMP_AGENT (20), ITEM_TYPE_SCRIPT (21), ITEM_TYPE_BROWSER (22).
snmp_oid	string	(required for SNMP_AGENT items) SNMP object ID.
key	string	(required) Item key.
delay	string	Update interval of the item. Default: 1m. The value will always be 0 for TRAP items.
history	string	Time period (using time suffix , user macro or LLD macro) of how long the history data should be stored. Default: 31d.
trends	string	Time period (using time suffix , user macro or LLD macro) of how long the trends data should be stored. Default: 365d.
status	string	Item status. Possible values: ¹ ENABLED (0, default), DISABLED (1).
value_type	string	Received value type. Possible values: ¹ FLOAT (0), CHAR (1), LOG (2), UNSIGNED (3, default), TEXT (4), BINARY (5).
allowed_hosts	string	List of comma-delimited IP addresses of hosts allowed to send data for the item. Supported for TRAP and HTTP_AGENT items.
units	string	Received value units (bps, B, etc.).
params	text	Additional parameters depending on the type of the item (executed script for SSH and TELNET items; SQL query for ODBC items; formula for CALCULATED items; the script for ITEM_TYPE_SCRIPT and ITEM_TYPE_BROWSER items).
ipmi_sensor	string	IPMI sensor. Supported for IPMI items.

Element	Type	Description
authtype	string	Authentication type. Supported for SSH and HTTP_AGENT items. Possible values for SSH items: ¹ PASSWORD (0, default), PUBLIC_KEY (1). Possible values for HTTP_AGENT items: ¹ NONE (0, default), BASIC (1), NTLM (2).
username	string	(required for SSH and TELNET items) Username for authentication. Supported for SIMPLE, ODBC, JMX and HTTP_AGENT items. When used for JMX items, password (see below) should also be specified or both elements should be left blank.
password	string	(required for SSH and TELNET items) Password for authentication. Supported for SIMPLE, ODBC, JMX and HTTP_AGENT items. When used for JMX items, username (see above) should also be specified or both elements should be left blank.
publickey	string	(required for SSH items) Name of the public key file.
privatekey	string	(required for SSH items) Name of the private key file.
description	text	Item description.
inventory_link	string	Host inventory field that is populated by the item. Possible values: ¹ NONE (0), ALIAS (4), etc. (see Host inventory for supported fields).
valuemap		Root element for item value maps.
name	string	(required) Name of the value map to use for the item.
logtimefmt	string	Format of the time in log entries. Supported for items of LOG value type.
preprocessing		Root element for item value preprocessing.
step		Root element for template item value preprocessing steps .
jmx_endpoint	string	JMX endpoint. Supported for JMX items.
master_item		(required for DEPENDENT items) Root element for dependent item's master item.
key	string	(required) Dependent item's master item key.
timeout	string	Item data polling request timeout. Supported for Timeouts list of item types.
url	string	(required for HTTP_AGENT items) URL string.
query_fields		Root element for query parameters. Supported for HTTP_AGENT items.
name	string	(required for HTTP_AGENT items) Query parameter name.
value	string	Query parameter value. Supported for HTTP_AGENT items.
parameters		Root element for user-defined parameters. Supported for ITEM_TYPE_SCRIPT and ITEM_TYPE_BROWSER items.
name	string	(required for ITEM_TYPE_SCRIPT and ITEM_TYPE_BROWSER items) User-defined parameter name.
value	string	User-defined parameter value. Supported for ITEM_TYPE_SCRIPT and ITEM_TYPE_BROWSER items.
posts	string	HTTP(S) request body data. Supported for HTTP_AGENT items.
status_codes	string	Ranges of required HTTP status codes, separated by commas. Supported for HTTP_AGENT items.
follow_redirects	string	Follow response redirects while polling data. Supported for HTTP_AGENT items. Possible values: ¹ NO (0), YES (1, default).
post_type	string	Type of post data body. Supported for HTTP_AGENT items. Possible values: ¹ RAW (0, default), JSON (2), XML (3).
http_proxy	string	HTTP(S) proxy connection string. Supported for HTTP_AGENT items.
headers		Root element for HTTP(S) request headers. Supported for HTTP_AGENT items.
name	string	(required for HTTP_AGENT items) Header name.
value	string	(required for HTTP_AGENT items) Header value.
retrieve_mode	string	What part of response should be stored. Supported for HTTP_AGENT items. Possible values: ¹ BODY (0, default), HEADERS (1), BOTH (2).

Element	Type	Description
request_method	string	Request method type. Supported for HTTP_AGENT items. Possible values: ¹ GET (0, default), POST (1), PUT (2), HEAD (3).
output_format	string	How to process response. Supported for HTTP_AGENT items. Possible values: ¹ RAW (0, default), JSON (1).
allow_traps	string	Allow to populate value similarly to the trapper item. Supported for HTTP_AGENT items. Possible values: ¹ NO (0, default), YES (1).
ssl_cert_file	string	Public SSL Key file path. Supported for HTTP_AGENT items.
ssl_key_file	string	Private SSL Key file path. Supported for HTTP_AGENT items.
ssl_key_password	string	Password for SSL Key file. Supported for HTTP_AGENT items.
verify_peer	string	Whether to validate that the host's certificate is authentic. Supported for HTTP_AGENT items. Possible values: ¹ NO (0, default), YES (1).
verify_host	string	Whether to validate that the host name for the connection matches the one in the host's certificate. Supported for HTTP_AGENT items. Possible values: ¹ NO (0, default), YES (1).
tags		Root element for item tags.
tag	string	(required) Tag name.
value	string	Tag value.
triggers		Root element for template item triggers .

Note:

See also: **Item object** (refer to the relevant property with a matching name).

Template item value preprocessing steps

Element	Type	Description
type	string	(required) The item value preprocessing step type. Possible values: ¹ MULTIPLIER (1), RTRIM (2), LTRIM (3), TRIM (4), REGEX (5), BOOL_TO_DECIMAL (6), OCTAL_TO_DECIMAL (7), HEX_TO_DECIMAL (8), SIMPLE_CHANGE (9, calculated: received value - previous value), CHANGE_PER_SECOND (10, calculated: (received value - previous value)/(time now - time of last check)), XMLPATH (11), JSONPATH (12), IN_RANGE (13), MATCHES_REGEX (14), NOT_MATCHES_REGEX (15), CHECK_JSON_ERROR (16), CHECK_XML_ERROR (17), CHECK_REGEX_ERROR (18), DISCARD_UNCHANGED (19), DISCARD_UNCHANGED_HEARTBEAT (20), JAVASCRIPT (21), PROMETHEUS_PATTERN (22), PROMETHEUS_TO_JSON (23), CSV_TO_JSON (24), STR_REPLACE (25), CHECK_NOT_SUPPORTED (26), XML_TO_JSON (27), SNMP_WALK_VALUE (28), SNMP_WALK_TO_JSON (29), SNMP_GET_VALUE (30).
parameters		(required) Root element for parameters of the item value preprocessing step.
parameter	string	Individual parameter of the item value preprocessing step.
error_handler	string	Action type used in case of preprocessing step failure. Possible values: ¹ ORIGINAL_ERROR (0, default), DISCARD_VALUE (1), CUSTOM_VALUE (2), CUSTOM_ERROR (3).
error_handler_params	string	Error handler parameters.

Note:

See also: **Item preprocessing object** (refer to the relevant property with a matching name).

Template item triggers

Element	Type	Description
uuid	string	(required) Unique identifier for this trigger.
expression	string	(required) Trigger expression.
recovery_mode	string	Basis for generating OK events. Possible values: ¹ EXPRESSION (0, default), RECOVERY_EXPRESSION (1), NONE (2).
recovery_expression	string	Trigger recovery expression.
correlation_mode	string	Correlation mode (no event correlation or event correlation by tag). Possible values: ¹ DISABLED (0, default), TAG_VALUE (1).
correlation_tag	string	The tag name to be used for event correlation.
name	string	(required) Trigger name.
event_name	string	Event name.
opdata	string	Operational data.
url_name	string	Label for the URL associated with the trigger.
url	string	URL associated with the trigger.
status	string	Trigger status. Possible values: ¹ ENABLED (0, default), DISABLED (1).
priority	string	Trigger severity. Possible values: ¹ NOT_CLASSIFIED (0, default), INFO (1), WARNING (2), AVERAGE (3), HIGH (4), DISASTER (5).
description	text	Trigger description.
type	string	Event generation type (single problem event or multiple problem events). Possible values: ¹ SINGLE (0, default), MULTIPLE (1).
manual_close	string	Manual closing of problem events. Possible values: ¹ NO (0, default), YES (1).
dependencies		Root element for dependencies.
name	string	(required) Dependency trigger name.
expression	string	(required) Dependency trigger expression.
recovery_expression	string	Dependency trigger recovery expression.
tags		Root element for trigger tags.
tag	string	(required) Tag name.
value	string	Tag value.

Note:

See also: [Trigger object](#) (refer to the relevant property with a matching name).

Template low-level discovery rules

Attention:

Most template low-level discovery rule elements are the same as for [template items](#). The table below describes those elements that differ from template items.

Element	Type	Description
type	string	Item type. Possible values: ¹ ZABBIX_PASSIVE (0, default), TRAP (2), SIMPLE (3), INTERNAL (5), ZABBIX_ACTIVE (7), EXTERNAL (10), ODBC (11), IPMI (12), SSH (13), TELNET (14), JMX (16), DEPENDENT (18), HTTP_AGENT (19), SNMP_AGENT (20), ITEM_TYPE_SCRIPT (21), ITEM_TYPE_BROWSER (22).
key	string	(required) The low-level discovery rule key.
filter		Root element for template low-level discovery rule filters .
lifetime	string	Time period (using seconds, time suffix , or user macro), after which no longer discovered resources will be deleted. Default: 7d.
lifetime_type	string	Scenario for deleting lost LLD resources. Possible values: DELETE_NEVER, DELETE_IMMEDIATELY, DELETE_AFTER.
enabled_lifetime	string	Time period (using seconds, time suffix , or user macro), after which no longer discovered resources will be disabled.
enabled_lifetime_type	string	Scenario for disabling lost LLD resources. Possible values: DISABLE_NEVER, DISABLE_IMMEDIATELY, DISABLE_AFTER.
item_prototypes		Root element for template item prototype elements, which are the same as for template items .

Element	Type	Description
trigger_prototypes		Root element for template trigger prototype elements, which are the same as for template item triggers .
graph_prototypes		Root element for template graph prototype elements, which are the same as for host graphs .
host_prototypes		Root element for template host prototype elements, which are the same as for hosts .
master_item	string	(required for DEPENDENT rules) Root element for the dependent rule's master item.
lld_macro_paths		Root element for low-level discovery rule macro paths.
lld_macro	string	(required) Low-level discovery rule macro name.
path	string	(required) Selector for value, which will be assigned to the corresponding macro.
preprocessing		Root element for low-level discovery rule value preprocessing.
step		Root element for low-level discovery rule value preprocessing step elements, which are the same as for template item value preprocessing steps , except with fewer possible values. See also: LLD rule preprocessing object .
overrides		Root element for low-level discovery rule override rules.
name	string	(required) Unique override name.
step	string	(required) Unique order number of the override.
stop	string	Stop processing next overrides if matches.
filter		Root element for template low-level discovery rule override rule filter elements, which are the same as for template low-level discovery rule filters .
operations		Root element for template low-level discovery rule override operations .

Note:

See also: [LLD rule object](#) (refer to the relevant property with a matching name).

Template low-level discovery rule filters

Element	Type	Description
evaltype	string	Override filter condition evaluation method. Possible values: ¹ AND_OR (0, default), AND (1), OR (2), FORMULA (3).
formula	string	Custom calculation formula for filter conditions.
conditions		Root element for filter conditions.
macro	string	(required) The name of the low-level discovery macro to perform the check on.
value	string	Value to compare with.
operator	string	Condition operator. Possible values: ¹ MATCHES_REGEX (8, default), NOT_MATCHES_REGEX (9).
formulaid	string	(required) Arbitrary unique ID that is used to reference a condition from the custom expression. Can only contain capital-case letters. The ID must be defined by the user when modifying filter conditions, but will be generated anew when requesting them afterward.

Note:

See also: [LLD rule filter object](#) (refer to the relevant property with a matching name).

Template low-level discovery rule override operations

Element	Type	Description
operationobject	string	Object to which the operation is applied. Possible values: ¹ ITEM_PROTOTYPE (0), TRIGGER_PROTOTYPE (1), GRAPH_PROTOTYPE (2), HOST_PROTOTYPE (3).
operator	string	Override condition operator. Possible values: ¹ EQUAL (1), NOT_EQUAL (2), LIKE (3), NOT_LIKE (4), REGEXP (5), NOT_REGEXP (6).
value	string	A regular expression or a string for the override condition operator.
status	string	Status of the object upon the override operation.
discover	string	Whether the object is added as a result of the discovery.
delay	string	Update interval set for the item prototype upon the override operation.
history	string	History storage period set for the item prototype upon the override operation.

Element	Type	Description
trends	string	Trend storage period set for the item prototype upon the override operation.
severity	string	Trigger prototype severity set upon the override operation.
tags		Root element for the tags set for the object upon the override operation.
tag	string	(required) Tag name.
value	string	Tag value.
templates		Root element for the templates linked to the host prototype upon the override operation.
name	string	(required) Template name.
inventory_mode	string	Host prototype inventory mode set upon the override operation.

Note:

See also: [LLD rule override operation object](#) (refer to the relevant property with a matching name).

Template web scenarios

Element	Type	Description
uuid	string	(required) Unique identifier for this web scenario.
name	string	(required) Web scenario name.
delay	string	Frequency (using seconds, time suffix , or user macro) of executing web scenario. Default: 1m.
attempts	integer	The number of attempts for executing web scenario steps. Possible values: ¹ 1-10 (default: 1).
agent	string	Client agent. Zabbix will pretend to be the selected browser. This is useful when a website returns different content for different browsers. Default: Zabbix.
http_proxy	string	Proxy that will be used by the web scenario given as: <code>http://[username[:password]@]proxy.example.com[:port]</code>
variables		Root element for web scenario variables that may be used in scenario steps.
name	string	(required) Variable name.
value	text	(required) Variable value.
headers		Root element for HTTP headers to be sent when performing a request. Headers should be listed using the same syntax as they would appear in the HTTP protocol.
name	string	(required) Header name.
value	text	(required) Header value.
status	string	Web scenario status. Possible values: ¹ ENABLED (0, default), DISABLED (1).
authentication	string	Authentication method. Possible values: ¹ NONE (0, default), BASIC (1), NTLM (2).
http_user	string	User name used for BASIC (HTTP) or NTLM authentication.
http_password	string	Password used for BASIC (HTTP) or NTLM authentication.
verify_peer	string	Verify the SSL certificate of the web server. Possible values: ¹ NO (0, default), YES (1).
verify_host	string	Verify that the <i>Common Name</i> field or the <i>Subject Alternate Name</i> field of the web server certificate matches. Possible values: ¹ NO (0, default), YES (1).
ssl_cert_file	string	Name of the SSL certificate file used for client authentication (must be in PEM format).
ssl_key_file	string	Name of the SSL private key file used for client authentication (must be in PEM format).
ssl_key_password	string	SSL private key file password.
steps		(required) Root element for template web scenario steps .
tags		Root element for web scenario tags.
tag	string	(required) Tag name.
value	string	Tag value.

Note:

See also: [Web scenario object](#) (refer to the relevant property with a matching name).

Template web scenario steps

Element	Type	Description
name	string	(required) Web scenario step name.
url	string	(required) URL for monitoring.
query_fields		Root element for query parameters (an array of HTTP fields to be added to the URL when performing a request).
name	string	(required) Query parameter name.
value	string	Query parameter value.
posts		Root element for HTTP POST variables (a string (raw post data) or an array of HTTP fields (form field data)).
name	string	(required) Post field name.
value	string	(required) Post field value.
variables		Root element of step-level variables (macros) that should be applied after this step. If the variable value has a 'regex:' prefix, then its value is extracted from the data returned by this step according to the regular expression pattern following the 'regex:' prefix
name	string	(required) Variable name.
value	text	(required) Variable value.
headers		Root element for HTTP headers to be sent when performing a request.
name	string	(required) Header name.
value	text	(required) Header value.
follow_redirects	string	Follow HTTP redirects. Possible values: ¹ NO (0), YES (1, default).
retrieve_mode	string	HTTP response retrieve mode. Possible values: ¹ BODY (0, default), HEADERS (1), BOTH (2).
timeout	string	Timeout (using seconds, time suffix , or user macro) of step execution. Default: 15s.
required	string	Text that must be present in the response (ignored if empty).
status_codes	string	A comma-delimited list of accepted HTTP status codes (e.g., 200–201, 210–299; ignored if empty).

Note:

See also: [Web scenario step object](#) (refer to the relevant property with a matching name).

Template dashboards

Element	Type	Description
uuid	string	(required) Unique identifier for this dashboard.
name	string	(required) Template dashboard name.
display	integer	Display period of dashboard pages.
pe- riod		
auto_start	string	Slideshow auto start. Possible values: ¹ NO (0), YES (1, default).
pages		Root element for template dashboard pages.
name	string	Page name.
display	integer	Page display period.
period		
sortorder	integer	Page sorting order.
widgets		Root element for template dashboard widgets .

Note:

See also: [Template dashboard object](#) (refer to the relevant property with a matching name).

Template dashboard widgets

Element	Type	Description
type	string	(required) Widget type.
name	string	Widget name.

Element	Type	Description
x	integer	Horizontal position from the left side of the template dashboard. Possible values: ¹ 0-71.
y	integer	Vertical position from the top of the template dashboard. Possible values: ¹ 0-63.
width	integer	Widget width. Possible values: ¹ 1-72.
height	integer	Widget height. Possible values: ¹ 1-64.
hide_header	string	Hide widget header. Possible values: ¹ NO (0, default), YES (1).
fields		Root element for the template dashboard widget fields.
type	string	(required) Widget field type. Possible values: ¹ INTEGER (0), STRING (1), ITEM (4), ITEM_PROTOTYPE (5), GRAPH (6), GRAPH_PROTOTYPE (7), MAP (8), SERVICE (9), SLA (10), USER (11), ACTION (12), MEDIA_TYPE (13).
name	string	(required) Widget field name.
value	mixed	(required) Widget field value, depending on the field type.

Note:

See also: [Template dashboard widget object](#) (refer to the relevant property with a matching name).

Template value maps

Element	Type	Description
uuid	string	(required) Unique identifier for this value map.
name	string	(required) Value map name.
mapping		Root element for mappings.
type	string	Mapping match type. Possible values: ¹ EQUAL (0, default), GREATER_OR_EQUAL (2), LESS_OR_EQUAL (3), IN_RANGE (4), REGEXP (5), DEFAULT (6).
value	string	Original value.
newvalue	string	(required) Value to which the original value is mapped to.

Note:

See also: [Value map object](#) (refer to the relevant property with a matching name).

Footnotes ¹ API integer values in brackets, for example, ENABLED (0), are mentioned only for reference. For more information, see the linked API object page in the table entry or at the end of each section.

4 Hosts

Overview

Hosts are **exported** with many related objects and object relations.

Host export contains:

- Linked **host groups**
- Host data
- Template linkage
- Host group linkage
- Host interfaces
- Directly linked items
- Directly linked triggers
- Directly linked discovery rules with all prototypes
- Directly linked web scenarios

- Host macros
- Host inventory data
- Value maps
- Linked **graphs**

Exporting

To export hosts, do the following:

1. Go to *Data collection* → *Hosts*.
2. Mark the checkboxes of the hosts to export.
3. Click *Export* below the list.

≡ Hosts

The screenshot shows the Zabbix Hosts interface. At the top, there is a table with columns: Name, Items, Triggers, Graphs, Discovery, and Web. The first row, 'Server1', is selected. Below the table, there is a toolbar with buttons: '1 selected', 'Enable', 'Disable', 'Export', 'Mass update', and 'Delete'. The 'Export' button is active, and a dropdown menu is open, showing options: 'YAML', 'XML', and 'JSON'.

<input type="checkbox"/>	Name ▲	Items	Triggers	Graphs	Discovery	Web
<input checked="" type="checkbox"/>	Server1	Items	Triggers	Graphs	Discovery	Web

1 selected **Export** ^

- YAML
- XML
- JSON

Depending on the selected format, hosts are exported to a local file with a default name:

- `zabbix_export_hosts.yaml` - in YAML export (default option for export);
- `zabbix_export_hosts.xml` - in XML export;
- `zabbix_export_hosts.json` - in JSON export.

Importing

To import hosts, do the following:

1. Go to *Data collection* → *Hosts*.
2. Click *Import* in the top right corner.
3. Select the import file.
4. Click *Import* in the bottom right corner of the configuration form.

Import
? X

* Import file

Advanced options

Rules	Update existing	Create new	Delete missing
All	<input checked="" type="checkbox"/>	<input checked="" type="checkbox"/>	<input checked="" type="checkbox"/>
Host groups	<input checked="" type="checkbox"/>	<input checked="" type="checkbox"/>	
Hosts	<input checked="" type="checkbox"/>	<input checked="" type="checkbox"/>	
Value mappings	<input checked="" type="checkbox"/>	<input checked="" type="checkbox"/>	<input checked="" type="checkbox"/>
Template linkage		<input checked="" type="checkbox"/>	<input checked="" type="checkbox"/>
Items	<input checked="" type="checkbox"/>	<input checked="" type="checkbox"/>	<input checked="" type="checkbox"/>
Discovery rules	<input checked="" type="checkbox"/>	<input checked="" type="checkbox"/>	<input checked="" type="checkbox"/>
Triggers	<input checked="" type="checkbox"/>	<input checked="" type="checkbox"/>	<input checked="" type="checkbox"/>
Graphs	<input checked="" type="checkbox"/>	<input checked="" type="checkbox"/>	<input checked="" type="checkbox"/>
Web scenarios	<input checked="" type="checkbox"/>	<input checked="" type="checkbox"/>	<input checked="" type="checkbox"/>

If you mark the *Advanced options* checkbox, a detailed list of all importable elements will be displayed - mark or unmark each import rule as required.

If you click the checkbox in the *All* row, all elements below it will be marked/unmarked.

Import rules:

Rule	Description
<i>Update existing</i>	Existing elements will be updated using data from the import file. Otherwise, they will not be updated.
<i>Create new</i>	New elements will be created using data from the import file. Otherwise, they will not be created.
<i>Delete missing</i>	Existing elements not present in the import file will be removed. Otherwise, they will not be removed. If <i>Delete missing</i> is marked for <i>Template linkage</i> , current template linkage not present in the import file will be unlinked. Entities (items, triggers, graphs, etc.) inherited from the unlinked templates will not be removed (unless the <i>Delete missing</i> option is selected for each entity as well).

A success or failure message of the import will be displayed in the frontend.

Export format

Export format in YAML:

```
zabbix_export:
  version: '7.2'
  host_groups:
    - uuid: f2481361f99448eea617b7b1d4765566
      name: 'Discovered hosts'
    - uuid: 6f6799aa69e844b4b3918f779f2abf08
      name: 'Zabbix servers'
  hosts:
    - host: 'Zabbix server 1'
      name: 'Main Zabbix server'
      monitored_by: 'SERVER'
      templates:
```

```

- name: 'Linux by Zabbix agent'
- name: 'Zabbix server health'
groups:
- name: 'Discovered hosts'
- name: 'Zabbix servers'
interfaces:
- ip: 192.168.1.1
  interface_ref: if1
items:
- name: 'Zabbix trap'
  type: TRAP
  key: trap
  delay: '0'
  history: 1w
  preprocessing:
  - type: MULTIPLIER
    parameters:
    - '8'
  tags:
  - tag: component
    value: 'raw'
  triggers:
  - expression: 'last(/Zabbix server 1/trap)=0'
    name: 'Last value is zero'
    priority: WARNING
    tags:
    - tag: scope
      value: 'availability'
tags:
- tag: service
  value: zabbix-server
macros:
- macro: '{$HOST.MACRO}'
  value: '123'
- macro: '{$PASSWORD1}'
  type: SECRET_TEXT
inventory:
  type: 'Zabbix server'
  name: yyyyyy-HP-Pro-3010-Small-Form-Factor-PC
  os: 'Linux yyyyyy-HP-Pro-3010-Small-Form-Factor-PC 4.4.0-165-generic #193-Ubuntu SMP Tue Sep 17 17
inventory_mode: AUTOMATIC
graphs:
- name: 'CPU utilization server'
  show_work_period: 'NO'
  show_triggers: 'NO'
  graph_items:
  - drawtype: FILLED_REGION
    color: FF5555
    item:
      host: 'Zabbix server 1'
      key: 'system.cpu.util[,steal]'
  - sortorder: '1'
    drawtype: FILLED_REGION
    color: 55FF55
    item:
      host: 'Zabbix server 1'
      key: 'system.cpu.util[,softirq]'
  - sortorder: '2'
    drawtype: FILLED_REGION
    color: '009999'
    item:
      host: 'Zabbix server 1'

```

```

    key: 'system.cpu.util[,interrupt]'
- sortorder: '3'
  drawtype: FILLED_REGION
  color: '990099'
  item:
    host: 'Zabbix server 1'
    key: 'system.cpu.util[,nice]'
- sortorder: '4'
  drawtype: FILLED_REGION
  color: '999900'
  item:
    host: 'Zabbix server 1'
    key: 'system.cpu.util[,iowait]'
- sortorder: '5'
  drawtype: FILLED_REGION
  color: '990000'
  item:
    host: 'Zabbix server 1'
    key: 'system.cpu.util[,system]'
- sortorder: '6'
  drawtype: FILLED_REGION
  color: '000099'
  calc_fnc: MIN
  item:
    host: 'Zabbix server 1'
    key: 'system.cpu.util[,user]'
- sortorder: '7'
  drawtype: FILLED_REGION
  color: '009900'
  item:
    host: 'Zabbix server 1'
    key: 'system.cpu.util[,idle]'

```

Exported elements Exported elements are explained in the tables below.

Element	Type	Description
version	string	(required) Zabbix version.
host_groups		(required) Root element for host groups.
	uuid	string (required) Unique identifier for this host group.
	name	string (required) Host group name.
hosts		Root element for hosts .

Hosts

Element	Type	Description
host	string	(required) Unique host name.
name	string	Visible host name.
description	text	Host description.
monitored_by	string	Host is monitored by: SERVER, PROXY, or PROXY_GROUP.
proxy		Root element for proxy.
name	string	(required) Name of the proxy (if any) that monitors the host.
proxy_group		Root element for proxy group.
name	string	(required) Name of the proxy group (if any) that is used to monitor the host.
status	string	Host status. Possible values: ¹ ENABLED (0, default), DISABLED (1).
ipmi_authtype	string	IPMI session authentication type. Possible values: ¹ DEFAULT (-1, default), NONE (0), MD2 (1), MD5 (2), STRAIGHT (4), OEM (5), RMCP_PLUS (6).
ipmi_privilege	string	IPMI session privilege level. Possible values: ¹ CALLBACK (1), USER (2, default), OPERATOR (3), ADMIN (4), OEM (5).

Element	Type	Description
ipmi_username	string	Username for IPMI checks.
ipmi_password	string	Password for IPMI checks.
templates		Root element for linked templates.
name	string	(required) Template name.
groups		Root element for host groups to which the host belongs.
name	string	(required) Host group name.
interfaces		Root element for host interfaces .
items		Root element for host items .
discovery_rules		Root element for host low-level discovery rules .
http_tests		Root element for host web scenarios .
tags		Root element for host tags.
tag	string	(required) Tag name.
value	string	Tag value.
macros		Root element for host macros.
macro	string	(required) User macro name.
type	string	User macro type. Possible values: ¹ TEXT (0, default), SECRET_TEXT (1), VAULT (2).
value	string	User macro value.
description	string	User macro description.
inventory		Root element for host inventory.
<inventory_property>	string	Inventory property. All properties have their respective element (type, name, os, etc.; for example, see Export format).
inventory_mode	string	Inventory mode. Possible values: ¹ DISABLED (-1), MANUAL (0, default), AUTOMATIC (1).
valuemaps		Root element for host value maps .

Note:

See also: [Host object](#) (refer to the relevant property with a matching name).

Host interfaces

Element	Type	Description
default	string	Whether this is the primary host interface. Note that there can be only one primary interface of one type on a host. Possible values: ¹ NO (0), YES (1, default).
type	string	Interface type. Possible values: ¹ ZABBIX (1, default), SNMP (2), IPMI (3), JMX (4).
useip	string	Whether to use IP as the interface for connecting to the host (otherwise, DNS will be used). Possible values: ¹ NO (0), YES (1, default).
ip	string	(required for IP connections) IP address (IPv4 or IPv6).
dns	string	(required for DNS connections) DNS name.
port	string	Port number.
details		Root element for interface details.
version	string	Use this SNMP version. Possible values: ¹ SNMPV1 (1), SNMP_V2C (2, default), SNMP_V3 (3).
community	string	(required for SNMPv1 and SNMPv2 items) SNMP community.
max_repetitions	string	Max repetition value for native SNMP bulk requests (GetBulkRequest-PDUs). Supported for SNMPv2 and SNMPv3 items (discovery[] and walk[] items). Default: 10.
contextname	string	SNMPv3 context name. Supported for SNMPv3 items.
securityname	string	SNMPv3 security name. Supported for SNMPv3 items.
securitylevel	string	SNMPv3 security level. Supported for SNMPv3 items. Possible values: ¹ NOAUTHNOPRIV (0, default), AUTHNOPRIV (1), AUTHPRIV (2).

Element	Type	Description
authprotocol	string	SNMPv3 authentication protocol. Supported for SNMPv3 items. Possible values: ¹ MD5 (0, default), SHA1 (1), SHA224 (2), SHA256 (3), SHA384 (4), SHA512 (5).
authpassphrase	string	SNMPv3 authentication passphrase. Supported for SNMPv3 items.
privprotocol	string	SNMPv3 privacy protocol. Supported for SNMPv3 items. Possible values: ¹ DES (0, default), AES128 (1), AES192 (2), AES256 (3), AES192C (4), AES256C (5).
privpassphrase	string	SNMPv3 privacy passphrase. Supported for SNMPv3 items.
bulk	string	Use bulk requests for SNMP. Possible values: ¹ NO (0), YES (1, default).
interface_ref	string	Interface reference name to be used in items (format: if<N>).

Note:

See also: [Host interface object](#) (refer to the relevant property with a matching name).

Host items

Element	Type	Description
name	string	(required) Item name.
type	string	Item type. Possible values: ¹ ZABBIX_PASSIVE (0, default), TRAP (2), SIMPLE (3), INTERNAL (5), ZABBIX_ACTIVE (7), EXTERNAL (10), ODBC (11), IPMI (12), SSH (13), TELNET (14), CALCULATED (15), JMX (16), SNMP_TRAP (17), DEPENDENT (18), HTTP_AGENT (19), SNMP_AGENT (20), ITEM_TYPE_SCRIPT (21), ITEM_TYPE_BROWSER (22).
snmp_oid	string	(required for SNMP_AGENT items) SNMP object ID.
key	string	(required) Item key.
delay	string	Update interval of the item. Default: 1m. The value will always be 0 for TRAP items.
history	string	Time period (using time suffix , user macro or LLD macro) of how long the history data should be stored. Default: 31d.
trends	string	Time period (using time suffix , user macro or LLD macro) of how long the trends data should be stored. Default: 365d.
status	string	Item status. Possible values: ¹ ENABLED (0, default), DISABLED (1).
value_type	string	Received value type. Possible values: ¹ FLOAT (0), CHAR (1), LOG (2), UNSIGNED (3, default), TEXT (4), BINARY (5).
allowed_hosts	string	List of comma-delimited IP addresses of hosts allowed to send data for the item. Supported for TRAP and HTTP_AGENT items.
units	string	Received value units (bps, B, etc.).
params	text	Additional parameters depending on the type of the item (executed script for SSH and TELNET items; SQL query for ODBC items; formula for CALCULATED items; the script for ITEM_TYPE_SCRIPT and ITEM_TYPE_BROWSER items).
ipmi_sensor	string	IPMI sensor. Supported for IPMI items.
authtype	string	Authentication type. Supported for SSH and HTTP_AGENT items. Possible values for SSH items: ¹ PASSWORD (0, default), PUBLIC_KEY (1). Possible values for HTTP_AGENT items: ¹ NONE (0, default), BASIC (1), NTLM (2).
username	string	(required for SSH and TELNET items) Username for authentication. Supported for SIMPLE, ODBC, JMX and HTTP_AGENT items. When used for JMX items, password (see below) should also be specified or both elements should be left blank.

Element	Type	Description
password	string	(required for SSH and TELNET items) Password for authentication. Supported for SIMPLE, ODBC, JMX and HTTP_AGENT items. When used for JMX items, username (see above) should also be specified or both elements should be left blank.
publickey	string	(required for SSH items) Name of the public key file.
privatekey	string	(required for SSH items) Name of the private key file.
description	text	Item description.
inventory_link	string	Host inventory field that is populated by the item. Possible values: ¹ NONE (0), ALIAS (4), etc. (see Host inventory for supported fields).
valuemap		Root element for item value maps.
name	string	(required) Name of the value map to use for the item.
logtimefmt	string	Format of the time in log entries. Supported for items of LOG value type.
preprocessing		Root element for item value preprocessing.
step		Root element for host item value preprocessing steps .
interface_ref	string	Reference to the host interface (format: <code>if<N></code>).
jmx_endpoint	string	JMX endpoint. Supported for JMX items.
master_item		(required for DEPENDENT items) Root element for dependent item's master item.
key	string	(required) Dependent item's master item key.
timeout	string	Item data polling request timeout. Supported for the Timeouts list of item types.
url	string	(required for HTTP_AGENT items) URL string.
query_fields		Root element for query parameters. Supported for HTTP_AGENT items.
name	string	(required for HTTP_AGENT items) Query parameter name.
value	string	Query parameter value. Supported for HTTP_AGENT items.
parameters		Root element for user-defined parameters. Supported for ITEM_TYPE_SCRIPT and ITEM_TYPE_BROWSER items.
name	string	(required for ITEM_TYPE_SCRIPT and ITEM_TYPE_BROWSER items) User-defined parameter name.
value	string	User-defined parameter value. Supported for ITEM_TYPE_SCRIPT and ITEM_TYPE_BROWSER items.
posts	string	HTTP(S) request body data. Supported for HTTP_AGENT items.
status_codes	string	Ranges of required HTTP status codes, separated by commas. Supported for HTTP_AGENT items.
follow_redirects	string	Follow response redirects while polling data. Supported for HTTP_AGENT items. Possible values: ¹ NO (0), YES (1, default).
post_type	string	Type of post data body. Supported for HTTP_AGENT items. Possible values: ¹ RAW (0, default), JSON (2), XML (3).
http_proxy	string	HTTP(S) proxy connection string. Supported for HTTP_AGENT items.
headers		Root element for HTTP(S) request headers. Supported for HTTP_AGENT items.
name	string	(required for HTTP_AGENT items) Header name.
value	string	(required for HTTP_AGENT items) Header value.
retrieve_mode	string	What part of response should be stored. Supported for HTTP_AGENT items. Possible values: ¹ BODY (0, default), HEADERS (1), BOTH (2).
request_method	string	Request method type. Supported for HTTP_AGENT items. Possible values: ¹ GET (0, default), POST (1), PUT (2), HEAD (3).
output_format	string	How to process response. Supported for HTTP_AGENT items. Possible values: ¹ RAW (0, default), JSON (1).
allow_traps	string	Allow to populate value similarly to the trapper item. Supported for HTTP_AGENT items. Possible values: ¹ NO (0, default), YES (1).

Element	Type	Description
ssl_cert_file	string	Public SSL Key file path. Supported for HTTP_AGENT items.
ssl_key_file	string	Private SSL Key file path. Supported for HTTP_AGENT items.
ssl_key_password	string	Password for SSL Key file. Supported for HTTP_AGENT items.
verify_peer	string	Whether to validate that the host's certificate is authentic. Supported for HTTP_AGENT items.
verify_host	string	Whether to validate that the host name for the connection matches the one in the host's certificate. Supported for HTTP_AGENT items. Possible values: ¹ NO (0, default), YES (1).
tags		Root element for item tags.
tag	string	(required) Tag name.
value	string	Tag value.
triggers		Root element for host item triggers .

Note:

See also: **Item object** (refer to the relevant property with a matching name).

Host item value preprocessing steps

Element	Type	Description
type	string	(required) The item value preprocessing step type. Possible values: ¹ MULTIPLIER (1), RTRIM (2), LTRIM (3), TRIM (4), REGEX (5), BOOL_TO_DECIMAL (6), OCTAL_TO_DECIMAL (7), HEX_TO_DECIMAL (8), SIMPLE_CHANGE (9, calculated: received value - previous value), CHANGE_PER_SECOND (10, calculated: (received value - previous value)/(time now - time of last check)), XMLPATH (11), JSONPATH (12), IN_RANGE (13), MATCHES_REGEX (14), NOT_MATCHES_REGEX (15), CHECK_JSON_ERROR (16), CHECK_XML_ERROR (17), CHECK_REGEX_ERROR (18), DISCARD_UNCHANGED (19), DISCARD_UNCHANGED_HEARTBEAT (20), JAVASCRIPT (21), PROMETHEUS_PATTERN (22), PROMETHEUS_TO_JSON (23), CSV_TO_JSON (24), STR_REPLACE (25), CHECK_NOT_SUPPORTED (26), XML_TO_JSON (27), SNMP_WALK_VALUE (28), SNMP_WALK_TO_JSON (29), SNMP_GET_VALUE (30).
parameters		(required) Root element for parameters of the item value preprocessing step.
parameter	string	Individual parameter of the item value preprocessing step.
error_handler	string	Action type used in case of preprocessing step failure. Possible values: ¹ ORIGINAL_ERROR (0, default), DISCARD_VALUE (1), CUSTOM_VALUE (2), CUSTOM_ERROR (3).
error_handler_params	string	Error handler parameters.

Note:

See also: **Item preprocessing object** (refer to the relevant property with a matching name).

Host item triggers

Element	Type	Description
uuid	string	(required) Unique identifier for this trigger.
expression	string	(required) Trigger expression.
recovery_mode	string	Basis for generating OK events. Possible values: ¹ EXPRESSION (0, default), RECOVERY_EXPRESSION (1), NONE (2).
recovery_expression	string	Trigger recovery expression.
correlation_mode	string	Correlation mode (no event correlation or event correlation by tag). Possible values: ¹ DISABLED (0, default), TAG_VALUE (1).
correlation_tag	string	The tag name to be used for event correlation.
name	string	(required) Trigger name.

Element	Type	Description
event_name	string	Event name.
opdata	string	Operational data.
url_name	string	Label for the URL associated with the trigger.
url	string	URL associated with the trigger.
status	string	Trigger status. Possible values: ¹ ENABLED (0, default), DISABLED (1).
priority	string	Trigger severity. Possible values: ¹ NOT_CLASSIFIED (0, default), INFO (1), WARNING (2), AVERAGE (3), HIGH (4), DISASTER (5).
description	text	Trigger description.
type	string	Event generation type (single problem event or multiple problem events). Possible values: ¹ SINGLE (0, default), MULTIPLE (1).
manual_close	string	Manual closing of problem events. Possible values: ¹ NO (0, default), YES (1).
dependencies		Root element for dependencies.
name	string	(required) Dependency trigger name.
expression	string	(required) Dependency trigger expression.
recovery_expression	string	Dependency trigger recovery expression.
tags		Root element for trigger tags.
tag	string	(required) Tag name.
value	string	Tag value.

Note:

See also: [Trigger object](#) (refer to the relevant property with a matching name).

Host low-level discovery rules

Attention:

Most host low-level discovery rule elements are the same as for [host items](#). The table below describes those elements that differ from host items.

Element	Type	Description
type	string	Item type. Possible values: ¹ ZABBIX_PASSIVE (0, default), TRAP (2), SIMPLE (3), INTERNAL (5), ZABBIX_ACTIVE (7), EXTERNAL (10), ODBC (11), IPMI (12), SSH (13), TELNET (14), JMX (16), DEPENDENT (18), HTTP_AGENT (19), SNMP_AGENT (20), ITEM_TYPE_SCRIPT (21), ITEM_TYPE_BROWSER (22).
key	string	(required) The low-level discovery rule key.
filter		Root element for host low-level discovery rule filters .
lifetime	string	Time period (using seconds, time suffix , or user macro), after which no longer discovered resources will be deleted. Default: 7d.
lifetime_type	string	Scenario for deleting lost LLD resources. Possible values: DELETE_NEVER, DELETE_IMMEDIATELY, DELETE_AFTER.
enabled_lifetime	string	Time period (using seconds, time suffix , or user macro), after which no longer discovered resources will be disabled.
enabled_lifetime_type	string	Scenario for disabling lost LLD resources. Possible values: DISABLE_NEVER, DISABLE_IMMEDIATELY, DISABLE_AFTER.
item_prototypes		Root element for host item prototype elements, which are the same as for host items .
trigger_prototypes		Root element for host trigger prototype elements, which are the same as for host item triggers .
graph_prototypes		Root element for host graph prototypes, which are the same as for host graphs .
host_prototypes		Root element for host prototypes, which are the same as for hosts .
master_item	string	(required for DEPENDENT rules) Root element for the dependent rule's master item.
lld_macro_paths		Root element for low-level discovery rule macro paths.
lld_macro	string	(required) Low-level discovery rule macro name.
path	string	(required) Selector for value, which will be assigned to the corresponding macro.
preprocessing		Root element for low-level discovery rule value preprocessing.

Element	Type	Description
step		Root element for low-level discovery rule value preprocessing step elements, which are the same as for host item value preprocessing steps , except with fewer possible values. See also: LLD rule preprocessing object .
overrides		Root element for low-level discovery rule override rules.
name	string	(required) Unique override name.
step	string	(required) Unique order number of the override.
stop	string	Stop processing next overrides if matches.
filter		Root element for low-level discovery rule override rule filter elements, which are the same as for host low-level discovery rule filters .
operations		Root element for host low-level discovery rule override operations .

Note:

See also: [LLD rule object](#) (refer to the relevant property with a matching name).

Host low-level discovery rule filters

Element	Type	Description
evaltype	string	Override filter condition evaluation method. Possible values: ¹ AND_OR (0, default), AND (1), OR (2), FORMULA (3).
formula	string	Custom calculation formula for filter conditions.
conditions		Root element for filter conditions.
macro	string	(required) The name of the low-level discovery macro to perform the check on.
value	string	Value to compare with.
operator	string	Condition operator. Possible values: ¹ MATCHES_REGEX (8, default), NOT_MATCHES_REGEX (9).
formulaid	string	(required) Arbitrary unique ID that is used to reference a condition from the custom expression. Can only contain capital-case letters. The ID must be defined by the user when modifying filter conditions, but will be generated anew when requesting them afterward.

Note:

See also: [LLD rule filter object](#) (refer to the relevant property with a matching name).

Host low-level discovery rule override operations

Element	Type	Description
operationobject	string	Object to which the operation is applied. Possible values: ¹ ITEM_PROTOTYPE (0), TRIGGER_PROTOTYPE (1), GRAPH_PROTOTYPE (2), HOST_PROTOTYPE (3).
operator	string	Override condition operator. Possible values: ¹ EQUAL (1), NOT_EQUAL (2), LIKE (3), NOT_LIKE (4), REGEXP (5), NOT_REGEXP (6).
value	string	A regular expression or a string for the override condition operator.
status	string	Status of the object upon the override operation.
discover	string	Whether the object is added as a result of the discovery.
delay	string	Update interval set for the item prototype upon the override operation.
history	string	History storage period set for the item prototype upon the override operation.
trends	string	Trend storage period set for the item prototype upon the override operation.
severity	string	Trigger prototype severity set upon the override operation.
tags		Root element for the tags set for the object upon the override operation.
tag	string	(required) Tag name.
value	string	Tag value.
templates		Root element for the templates linked to the host prototype upon the override operation.
name	string	(required) Template name.
inventory_mode	string	Host prototype inventory mode set upon the override operation.

Note:

See also: [LLD rule override operation object](#) (refer to the relevant property with a matching name).

Host web scenarios

Element	Type	Description
uuid	string	(required) Unique identifier for this web scenario.
name	string	(required) Web scenario name.
delay	string	Frequency (using seconds, time suffix , or user macro) of executing web scenario. Default: 1m.
attempts	integer	The number of attempts for executing web scenario steps. Possible values: 1-10 (default: 1).
agent	string	Client agent. Zabbix will pretend to be the selected browser. This is useful when a website returns different content for different browsers. Default: Zabbix.
http_proxy	string	Proxy that will be used by the web scenario given as: <code>http://[username[:password]@]proxy.example.com[:port]</code>
variables		Root element for web scenario variables that may be used in scenario steps.
name	string	(required) Variable name.
value	text	(required) Variable value.
headers		Root element for HTTP headers to be sent when performing a request. Headers should be listed using the same syntax as they would appear in the HTTP protocol.
name	string	(required) Header name.
value	text	(required) Header value.
status	string	Web scenario status. Possible values: ¹ ENABLED (0, default), DISABLED (1).
authentication	string	Authentication method. Possible values: ¹ NONE (0, default), BASIC (1), NTLM (2).
http_user	string	User name used for BASIC (HTTP) or NTLM authentication.
http_password	string	Password used for BASIC (HTTP) or NTLM authentication.
verify_peer	string	Verify the SSL certificate of the web server. Possible values: ¹ NO (0, default), YES (1).
verify_host	string	Verify that the <i>Common Name</i> field or the <i>Subject Alternate Name</i> field of the web server certificate matches. Possible values: ¹ NO (0, default), YES (1).
ssl_cert_file	string	Name of the SSL certificate file used for client authentication (must be in PEM format).
ssl_key_file	string	Name of the SSL private key file used for client authentication (must be in PEM format).
ssl_key_password	string	SSL private key file password.
steps		(required) Root element for host web scenario steps .
tags		Root element for web scenario tags.
tag	string	(required) Tag name.
value	string	Tag value.

Note:

See also: [Web scenario object](#) (refer to the relevant property with a matching name).

Host web scenario steps

Element	Type	Description
name	string	(required) Web scenario step name.
url	string	(required) URL for monitoring.
query_fields		Root element for query parameters (an array of HTTP fields to be added to the URL when performing a request).
name	string	(required) Query parameter name.
value	string	Query parameter value.
posts		Root element for HTTP POST variables (a string (raw post data) or an array of HTTP fields (form field data)).
name	string	(required) Post field name.
value	string	(required) Post field value.

Element	Type	Description
variables		Root element of step-level variables (macros) that should be applied after this step. If the variable value has a 'regex:' prefix, then its value is extracted from the data returned by this step according to the regular expression pattern following the 'regex:' prefix
name	string	(required) Variable name.
value	text	(required) Variable value.
headers		Root element for HTTP headers to be sent when performing a request.
name	string	(required) Header name.
value	text	(required) Header value.
follow_redirects	string	Follow HTTP redirects. Possible values: ¹ NO (0), YES (1, default).
retrieve_mode	string	HTTP response retrieve mode. Possible values: ¹ BODY (0, default), HEADERS (1), BOTH (2).
timeout	string	Timeout (using seconds, time suffix , or user macro) of step execution. Default: 15s.
required	string	Text that must be present in the response (ignored if empty).
status_codes	string	A comma-delimited list of accepted HTTP status codes (e.g., 200–201, 210–299; ignored if empty).

Note:

See also: **Web scenario step object** (refer to the relevant property with a matching name).

Host graphs

Element	Type	Description
uuid	string	Unique identifier of the graph.
name	string	(required) Graph name.
width	integer	Graph width, in pixels. Used for preview and for pie/exploded graphs. Possible values: ¹ 20-65535 (default: 900).
height	integer	Graph height, in pixels. Used for preview and for pie/exploded graphs. Possible values: ¹ 20-65535 (default: 900).
yaxismin	double	Value of Y axis minimum. Supported for FIXED minimum value of Y axis. Default: 0.
yaxismax	double	Value of Y axis maximum. Supported for FIXED minimum value of X axis. Default: 0.
show_work_period	string	Highlight non-working hours. Supported for NORMAL and STACKED graphs. Possible values: ¹ NO (0), YES (1, default).
show_triggers	string	Display simple trigger values as a line. Supported for NORMAL and STACKED graphs. Possible values: ¹ NO (0), YES (1, default).
type	string	Graph type. Possible values: ¹ NORMAL (0, default), STACKED (1), PIE (2), EXPLODED (3).
show_legend	string	Display graph legend. Possible values: ¹ NO (0), YES (1, default).
show_3d	string	Enable 3D style. Supported for NORMAL and STACKED graphs. Possible values: ¹ NO (0, default), YES (1).
percent_left	double	Show the percentile line for left axis. Supported for NORMAL graphs. Default: 0.
percent_right	double	Show the percentile line for right axis. Supported for NORMAL graphs. Default: 0.

Element	Type	Description
ymin_type_1	string	Minimum value of Y axis. Supported for NORMAL and STACKED graphs. Possible values: ¹ CALCULATED (0, default), FIXED (1), ITEM (2).
ymin_item_1		(required if ymin_type_1 is set to ITEM) Root element for individual item details.
host	string	(required) Item host.
key	string	(required) Item key.
ymax_type_1	string	Maximum value of Y axis. Supported for NORMAL and STACKED graphs. Possible values: ¹ CALCULATED (0, default), FIXED (1), ITEM (2).
ymax_item_1		(required if ymax_type_1 is set to ITEM) Root element for individual item details.
host	string	(required) Item host.
key	string	(required) Item key.
graph_items		(required) Root element for host graph items .

Note:

See also: **Graph object** (refer to the relevant property with a matching name).

Host graph items

Element	Type	Description
sortorder	integer	Draw order. The smaller value is drawn first. Can be used to draw lines or regions behind (or in front of) another.
drawtype	string	Draw style of the graph item. Supported for NORMAL graphs. Possible values: ¹ SINGLE_LINE (0, default), FILLED_REGION (1), BOLD_LINE (2), DOTTED_LINE (3), DASHED_LINE (4), GRADIENT_LINE (5).
color	string	Element color (6 symbols, hex).
yaxisside	string	Side of the graph where the graph item's Y scale will be drawn. Supported for NORMAL and STACKED graphs.
calc_fnc	string	Data to draw if more than one value exists for an item. Possible values: ¹ MIN (1), AVG (2, default), MAX (4), ALL (7; minimum, average, and maximum; supported for simple graphs), LAST (9, supported for pie/exploded graphs).
type	string	Graph item type. Possible values: ¹ SIMPLE (0, default), GRAPH_SUM (2; value of the item represents the whole pie; supported for pie/exploded graphs).
item		(required) Individual item.
host	string	(required) Item host.
key	string	(required) Item key.

Note:

See also: **Graph item object** (refer to the relevant property with a matching name).

Host value maps

Element	Type	Description
uuid	string	(required) Unique identifier for this value map.
name	string	(required) Value map name.
mapping		Root element for mappings.
type	string	Mapping match type. Possible values: ¹ EQUAL (0, default), GREATER_OR_EQUAL (2), LESS_OR_EQUAL (3), IN_RANGE (4), REGEXP (5), DEFAULT (6).
value	string	Original value.
newvalue	string	(required) Value to which the original value is mapped to.

Note:

See also: **Value map object** (refer to the relevant property with a matching name).

Footnotes ¹ API integer values in brackets, for example, ENABLED (0), are mentioned only for reference. For more information, see the linked API object page in the table entry or at the end of each section.

5 Network maps

Overview

Network map **export** contains:

- All related images
- Map structure (all map settings, all contained elements with their settings, map links and map link status indicators)

Warning:

Any host groups, hosts, triggers, other maps or other elements that may be related to the exported map are not exported. Thus, if at least one of the elements the map refers to is missing, importing it will fail.

Exporting

To export network maps, do the following:

1. Go to *Monitoring* → *Maps*.
2. Mark the checkboxes of the network maps to export.
3. Click *Export* below the list.

≡ Maps

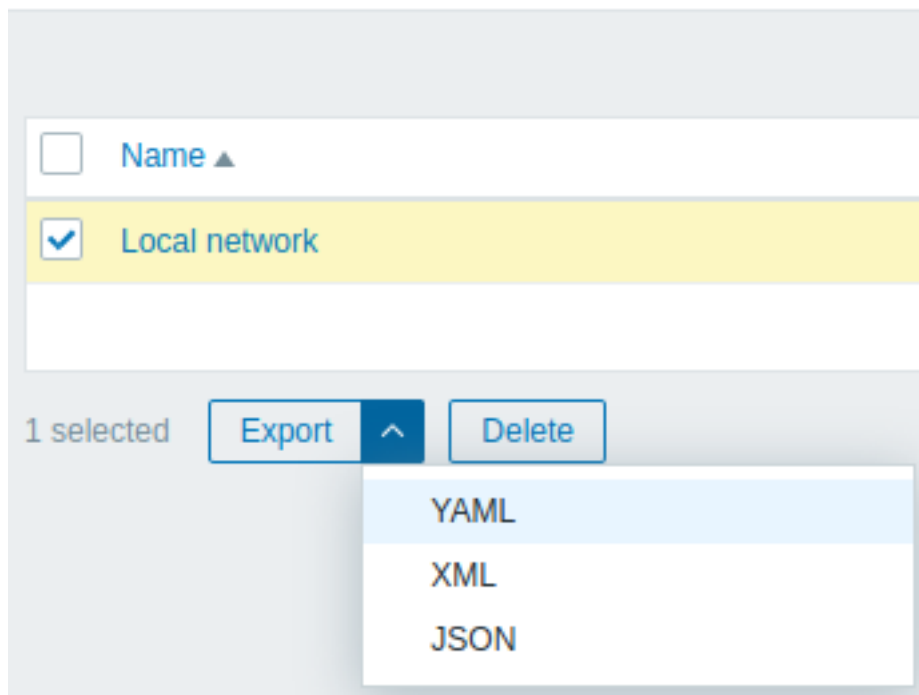

Depending on the selected format, maps are exported to a local file with a default name:

- `zabbix_export_maps.yaml` - in YAML export (default option for export);
- `zabbix_export_maps.xml` - in XML export;
- `zabbix_export_maps.json` - in JSON export.

Importing

To import network maps, do the following:

1. Go to *Monitoring* → *Maps*.
2. Click *Import* in the top right corner.
3. Select the import file.
4. Mark the required options in import rules.
5. Click *Import* in the bottom right corner of the configuration form.

Import ? X

* Import file

Rules	Update existing	Create new
Maps	<input checked="" type="checkbox"/>	<input checked="" type="checkbox"/>
Images	<input type="checkbox"/>	<input checked="" type="checkbox"/>

Import rules:

Rule	Description
<i>Update existing</i>	Existing maps will be updated using data from the import file. Otherwise, they will not be updated.
<i>Create new</i>	New maps will be created using data from the import file. Otherwise, they will not be created.

If you uncheck both map options and check the respective options for images, images only will be imported. Image importing is only available to *Super admin* users.

A success or failure message of the import will be displayed in the frontend.

Warning:
If replacing an existing image, it will affect all maps that are using this image.

Export format

Export to YAML:

```

zabbix_export:
  version: '7.2'
  images:
    - name: Zabbix_server_3D_(128)
      imagetype: '1'
      encodedImage: iVBOR...5CYII=
  maps:
    - name: 'Local network'
      width: '680'
      height: '200'
      label_type: '0'
      label_location: '0'
      highlight: '1'
      expandproblem: '1'
      markelements: '1'
      show_unack: '0'
      severity_min: '0'
      show_suppressed: '0'
      grid_size: '50'
      grid_show: '1'
      grid_align: '1'
      label_format: '0'
      label_type_host: '2'
      label_type_hostgroup: '2'
      label_type_trigger: '2'
      label_type_map: '2'
      label_type_image: '2'
      label_string_host: ''
      label_string_hostgroup: ''
      label_string_trigger: ''

```

```

label_string_map: ''
label_string_image: ''
expand_macros: '1'
background: { }
iconmap: { }
urls: { }
selements:
  - elementtype: '0'
    elements:
      - host: 'Zabbix server'
    label: |
      {HOST.NAME}
      {HOST.CONN}
    label_location: '0'
    x: '111'
    'y': '61'
    elementsubtype: '0'
    areatype: '0'
    width: '200'
    height: '200'
    viewtype: '0'
    use_iconmap: '0'
    selementid: '1'
    icon_off:
      name: Zabbix_server_3D_(128)
    icon_on: { }
    icon_disabled: { }
    icon_maintenance: { }
    urls: { }
    evaltype: '0'
shapes:
  - type: '0'
    x: '0'
    'y': '0'
    width: '680'
    height: '15'
    text: '{MAP.NAME}'
    font: '9'
    font_size: '11'
    font_color: '000000'
    text_halign: '0'
    text_valign: '0'
    border_type: '0'
    border_width: '0'
    border_color: '000000'
    background_color: ''
    zindex: '0'
lines: { }
links: { }

```

Exported elements Exported elements are explained in the table below.

Element	Type	Description
images		Root element for images.
name	string	Unique image name.
imagetype	integer	Image type. Possible values: 1 - Image; 2 - Background.
encodedImagestring		Base64 encoded image.
maps		Root element for maps .

Maps

Element	Type	Description
name	string	Unique map name.
width	integer	Map width, in pixels.
height	integer	Map height, in pixels.
label_type	integer	Map element label type. Possible values: 0 - Label; 1 - Host IP address; 2 - Element name; 3 - Status only; 4 - Nothing.
label_location	integer	Map element label location by default. Possible values: 0 - Bottom; 1 - Left; 2 - Right; 3 - Top.
highlight	integer	Enable icon highlighting for active triggers and host statuses. Possible values: 0 - No; 1 - Yes.
expandproblem	integer	Display problem trigger for elements with a single problem. Possible values: 0 - No; 1 - Yes.
markelements	integer	Highlight map elements that have recently changed their status. Possible values: 0 - No; 1 - Yes.
show_unack	integer	Problem display. Possible values: 0 - Count of all problems; 1 - Count of unacknowledged problems; 2 - Count of acknowledged and unacknowledged problems separately.
severity_min	integer	Minimum trigger severity to show on the map by default. Possible values: 0 - Not classified; 1 - Information; 2 - Warning; 3 - Average; 4 - High; 5 - Disaster.
show_suppressed	integer	Display problems, which would otherwise be suppressed (not shown) because of host maintenance. Possible values: 0 - No; 1 - Yes.
grid_size	integer	Cell size of a map grid in pixels. Supported if <code>grid_show</code> is set to 0. Possible values: 20, 40, 50, 75 or 100.
grid_show	integer	Display a grid in map configuration. Possible values: 0 - Yes; 1 - No.
grid_align	integer	Automatically align icons in map configuration. Possible values: 0 - Yes; 1 - No.

Element	Type	Description
label_format	integer	Use advanced label configuration. Possible values: 0 - No; 1 - Yes.
label_type_host	integer	Display label as host label. Supported if label_format is set to 1. Possible values: 0 - Label; 1 - Host IP address; 2 - Element name; 3 - Status only; 4 - Nothing; 5 - Custom label.
label_type_hostgroup	integer	Display label as host group label. Supported if label_format is set to 1. Possible values: 0 - Label; 2 - Element name; 3 - Status only; 4 - Nothing; 5 - Custom label.
label_type_trigger	integer	Display label as trigger label. Supported if label_format is set to 1. Possible values: 0 - Label; 2 - Element name; 3 - Status only; 4 - Nothing; 5 - Custom label.
label_type_map	integer	Display label as map label. Supported if label_format is set to 1. Possible values: 0 - Label; 2 - Element name; 3 - Status only; 4 - Nothing; 5 - Custom label.
label_type_image	integer	Display label as image label. Supported if label_format is set to 1. Possible values: 0 - Label; 2 - Element name; 4 - Nothing; 5 - Custom label.
label_string_host	string	Custom label for host elements. Supported if label_type_host is set to 5.
label_string_hostgroup	string	Custom label for host group elements. Supported if label_type_hostgroup is set to 5.
label_string_trigger	string	Custom label for trigger elements. Supported if label_type_trigger is set to 5.
label_string_map	string	Custom label for map elements. Supported if label_type_map is set to 5.
label_string_image	string	Custom label for image elements. Supported if label_type_image is set to 5.
expand_macros	integer	Expand macros in labels in map configuration. Possible values: 0 - No; 1 - Yes.
background		Root element for background image (if any). Supported if imagetype is set to 2.
name	string	Background image name.

Element	Type	Description
iconmap		Root element for icon mapping (if any).
name	string	Icon mapping name.
urls		Root element for URLs used by maps or each map element.
name	string	Link name.
url	string	Link URL.
elementtype	integer	Map item type the link belongs to. Possible values: 0 - Host; 1 - Map; 2 - Trigger; 3 - Host group; 4 - Image.
selements		Root element for map selements .
shapes		Root element for map shapes.
type	integer	Shape type. Possible values: 0 - Rectangle; 1 - Ellipse.
x	integer	X coordinates of the shape in pixels.
y	integer	Y coordinates of the shape in pixels.
width	integer	Shape width.
height	integer	Shape height.
text	string	Text inside of shape.
font	integer	Text font style. Possible values: 0 - Georgia, serif; 1 - "Palatino Linotype", "Book Antiqua", Palatino, serif; 2 - "Times New Roman", Times, serif; 3 - Arial, Helvetica, sans-serif; 4 - "Arial Black", Gadget, sans-serif; 5 - "Comic Sans MS", cursive, sans-serif; 6 - Impact, Charcoal, sans-serif; 7 - "Lucida Sans Unicode", "Lucida Grande", sans-serif; 8 - Tahoma, Geneva, sans-serif; 9 - "Trebuchet MS", Helvetica, sans-serif; 10 - Verdana, Geneva, sans-serif; 11 - "Courier New", Courier, monospace; 12 - "Lucida Console", Monaco, monospace.
font_size	integer	Font size in pixels.
font_color	string	Font color represented in hexadecimal code.
text_halign	integer	Horizontal alignment of text. Possible values: 0 - Center; 1 - Left; 2 - Right.
text_valign	integer	Vertical alignment of text. Possible values: 0 - Middle; 1 - Top; 2 - Bottom.
border_type	integer	Type of the border for the shape. Possible values: 0 - None; 1 - Bold line; 2 - Dotted line; 3 - Dashed line.
border_width	integer	Width of the border in pixels.
border_color	string	Border color represented in hexadecimal code.
background_color	string	Background (fill) color represented in hexadecimal code.
zindex	integer	Value for ordering all shapes and lines (z-index).
lines		Root element for map lines.

Element	Type	Description
x1	integer	X coordinates of the line point 1 in pixels.
y1	integer	Y coordinates of the line point 1 in pixels.
x2	integer	X coordinates of the line point 2 in pixels.
y2	integer	Y coordinates of the line point 2 in pixels.
line_type	integer	Line type. Possible values: 0 - None; 1 - Bold line; 2 - Dotted line; 3 - Dashed line.
line_width	integer	Line width in pixels.
line_color	string	Line color represented in hexadecimal code.
zindex	integer	Value for ordering all shapes and lines (z-index).
links		Root element for links between map elements.
drawtype	integer	Link style. Possible values: 0 - Line; 2 - Bold line; 3 - Dotted line; 4 - Dashed line.
color	string	Link color (6 symbols, hex).
label	string	Link label.
selementid1	id	ID of one element to connect.
selementid2	id	ID of the other element to connect.
linktriggers		Root element for link status indicators .

Note:

See also: [Map object](#) (refer to the relevant property with a matching name).

Map selements

Element	Type	Description
elementtype	integer	Map element type. Possible values: 0 - Host; 1 - Map; 2 - Trigger; 3 - Host group; 4 - Image.
elements		Root element for Zabbix entities (host, host group, map, etc.) that are represented on the map. All entities have their respective element (<code>host</code> , etc.; see, for example, Export format).
label	string	Icon label.
label_location	integer	Label location. Possible values: -1 - Use map default; 0 - Bottom; 1 - Left; 2 - Right; 3 - Top.
x	integer	Location on the X axis.
y	integer	Location on the Y axis.
elementsubtype	integer	Element subtype. Supported if <code>elementtype</code> is set to 3. Possible values: 0 - Single host group; 1 - All host groups.

Element	Type	Description
areatype	integer	Area size. Supported if <code>elementtype</code> is set to 1. Possible values: 0 - Same as whole map; 1 - Custom size.
width	integer	Width of area. Supported if <code>areatype</code> is set to 1.
height	integer	Height of area. Supported if <code>areatype</code> is set to 1.
viewtype	integer	Area placement algorithm. Supported if <code>elementsubtype</code> is set to 1. Possible values: 0 - Place evenly in the area.
use_iconmap	integer	Use icon mapping for this element. Relevant only if icon mapping is activated on map level. Possible values: 0 - No; 1 - Yes.
selementid	id	Unique element record ID.
icon_off		Root element for image to use when element is in 'OK' status.
name	string	Unique image name.
icon_on		Root element for image to use when element is in 'Problem' status.
name	string	Unique image name.
icon_disabled		Root element for image to use when element is disabled.
name	string	Unique image name.
icon_maintenance		Root element for image to use when element is in maintenance.
name	string	Unique image name.
urls		Root element for URLs used by maps or each map element.
name	string	Link name.
url	string	Link URL.
evaltype	integer	Evaluation type for tags.
tags		Root element for problem tags (for host and host group elements). If tags are given, only problems with these tags will be displayed on the map.
tag	string	Tag name.
value	string	Tag value.
operator	integer	Operator.

Note:

See also: [Map element object](#) (refer to the relevant property with a matching name).

Map link status indicators

Element	Type	Description
drawtype	integer	Link style when trigger is in the 'Problem' state. Possible values: 0 - Line; 2 - Bold line; 3 - Dotted line; 4 - Dashed line.
color	string	Link color (6 symbols, hex) when trigger is in the 'Problem' state.
trigger		Root element for trigger used to indicate link status.
description	string	Trigger name.
expression	string	Trigger expression.
recovery_expression	string	Trigger recovery expression.

Note:

See also: [Map link trigger object](#) (refer to the relevant property with a matching name).

6 Media types

Overview

Media types are **exported** with all related objects and object relations.

Exporting

To export media types, do the following:

1. Go to *Alerts* → *Media types*.
2. Mark the checkboxes of the media types to export.
3. Click *Export* below the list.

☰ Media types

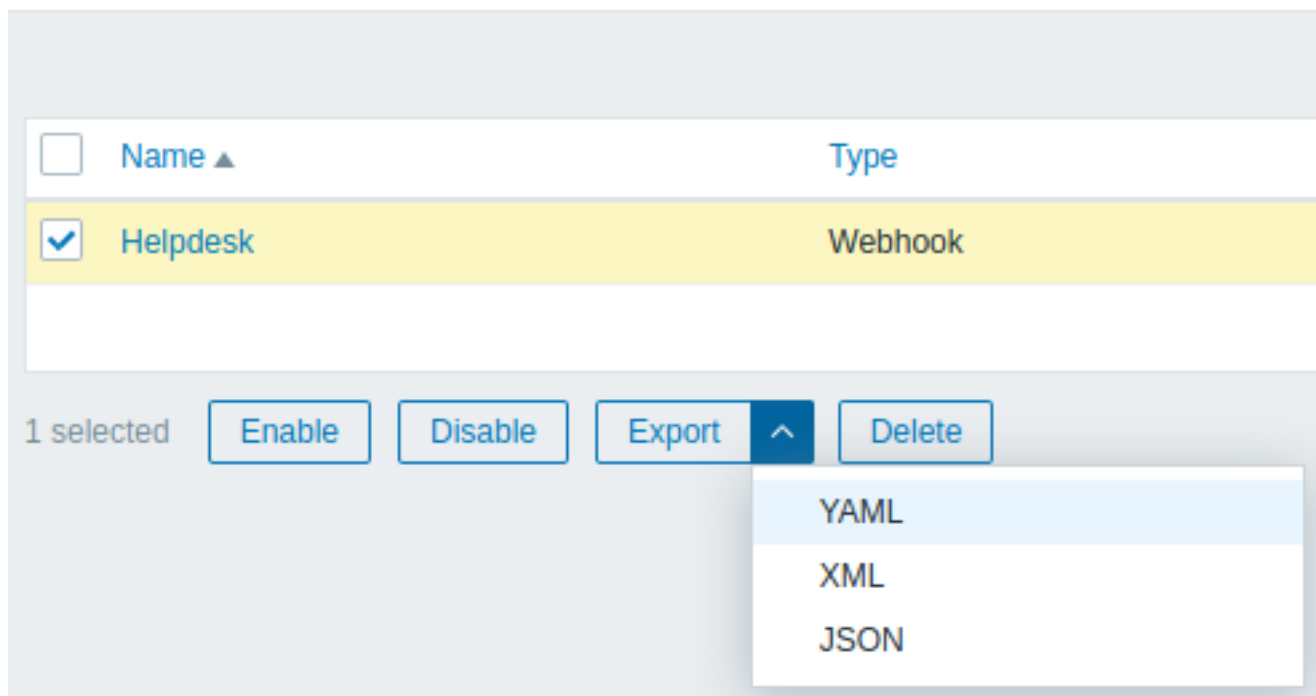

The screenshot shows a table with two columns: 'Name' and 'Type'. The first row is highlighted in yellow and contains 'Helpdesk' under 'Name' and 'Webhook' under 'Type'. A checkbox next to 'Helpdesk' is checked. Below the table, there are buttons for 'Enable', 'Disable', 'Export', and 'Delete'. The 'Export' button is active, and a dropdown menu is open, showing options for 'YAML', 'XML', and 'JSON'.

Depending on the selected format, media types are exported to a local file with a default name:

- `zabbix_export_mediatypes.yaml` - in YAML export (default option for export);
- `zabbix_export_mediatypes.xml` - in XML export;
- `zabbix_export_mediatypes.json` - in JSON export.

Importing

To import media types, do the following:

1. Go to *Alerts* → *Media types*.
2. Click *Import* in the top right corner.
3. Select the import file.
4. Mark the required options in import rules.
5. Click *Import* in the bottom right corner of the configuration form.

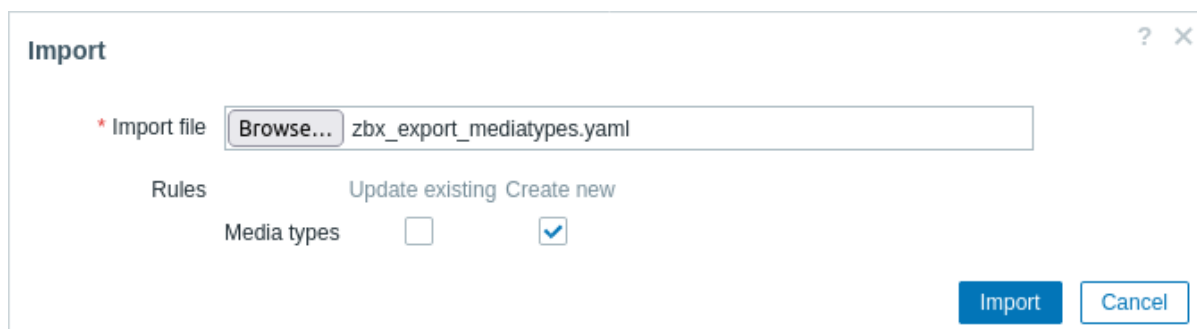

The screenshot shows the 'Import' dialog box. It has a title bar with a question mark and a close button. The main content area includes a field for the import file, currently showing 'zbx_export_mediatypes.yaml' with a 'Browse...' button. Below this, there are two radio buttons for 'Rules': 'Update existing' (selected) and 'Create new'. Underneath, there are two checkboxes for 'Media types': one is unchecked and the other is checked. At the bottom right, there are 'Import' and 'Cancel' buttons.

Import rules:

Rule	Description
<i>Update existing</i>	Existing elements will be updated using data from the import file. Otherwise, they will not be updated.
<i>Create new</i>	New elements will be created using data from the import file. Otherwise, they will not be created.

A success or failure message of the import will be displayed in the frontend.

Export format

Export to YAML:

```
zabbix_export:
  version: '7.2'
  media_types:
    - name: Pushover
      type: WEBHOOK
      parameters:
        - name: endpoint
          value: 'https://api.pushover.net/1/messages.json'
        - name: eventid
          value: '{EVENT.ID}'
        - name: event_nseverity
          value: '{EVENT.NSEVERITY}'
        - name: event_source
          value: '{EVENT.SOURCE}'
        - name: event_value
          value: '{EVENT.VALUE}'
        - name: expire
          value: '1200'
        - name: message
          value: '{ALERT.MESSAGE}'
        - name: priority_average
          value: '0'
        - name: priority_default
          value: '0'
        - name: priority_disaster
          value: '0'
        - name: priority_high
          value: '0'
        - name: priority_information
          value: '0'
        - name: priority_not_classified
          value: '0'
        - name: priority_warning
          value: '0'
        - name: retry
          value: '60'
        - name: title
          value: '{ALERT.SUBJECT}'
        - name: token
          value: '<PUSHOVER TOKEN HERE>'
        - name: triggerid
          value: '{TRIGGER.ID}'
        - name: url
          value: '{$ZABBIX.URL}'
        - name: url_title
          value: Zabbix
        - name: user
          value: '{ALERT.SENDTO}'
      status: DISABLED
```

```

max_sessions: '0'
script: |
  try {
    var params = JSON.parse(value),
        request = new HttpRequest(),
        data,
        response,
        severities = [
          {name: 'not_classified', color: '#97AAB3'},
          {name: 'information', color: '#7499FF'},
          {name: 'warning', color: '#FFC859'},
          {name: 'average', color: '#FFA059'},
          {name: 'high', color: '#E97659'},
          {name: 'disaster', color: '#E45959'},
          {name: 'resolved', color: '#009900'},
          {name: 'default', color: '#000000'}
        ],
        priority;

    if (typeof params.HTTPProxy === 'string' && params.HTTPProxy.trim() !== '') {
      request.setProxy(params.HTTPProxy);
    }

    if ([0, 1, 2, 3].indexOf(parseInt(params.event_source)) === -1) {
      throw 'Incorrect "event_source" parameter given: "' + params.event_source + '".\nMust be 0 or 1';
    }

    if (params.event_value !== '0' && params.event_value !== '1'
        && (params.event_source === '0' || params.event_source === '3')) {
      throw 'Incorrect "event_value" parameter given: "' + params.event_value + '".\nMust be 0 or 1';
    }

    if ([0, 1, 2, 3, 4, 5].indexOf(parseInt(params.event_nseverity)) === -1) {
      params.event_nseverity = '7';
    }

    if (params.event_value === '0') {
      params.event_nseverity = '6';
    }

    priority = params['priority_' + severities[params.event_nseverity].name] || params.priority_default;

    if (isNaN(priority) || priority < -2 || priority > 2) {
      throw '"priority" should be -2..2';
    }

    if (params.event_source === '0' && isNaN(params.triggerid)) {
      throw 'field "triggerid" is not a number';
    }

    if (isNaN(params.eventid)) {
      throw 'field "eventid" is not a number';
    }

    if (typeof params.message !== 'string' || params.message.trim() === '') {
      throw 'field "message" cannot be empty';
    }

    data = {
      token: params.token,
      user: params.user,
      title: params.title,

```



```

    message: params.message,
    url: (params.event_source === '0')
        ? params.url + '/tr_events.php?triggerid=' + params.triggerid + '&eventid=' + params.e
        : params.url,
    url_title: params.url_title,
    priority: priority
};

if (priority == 2) {
    if (isNaN(params.retry) || params.retry < 30) {
        throw 'field "retry" should be a number with value of at least 30 if "priority" is set
    }

    if (isNaN(params.expire) || params.expire > 10800) {
        throw 'field "expire" should be a number with value of at most 10800 if "priority" is
    }

    data.retry = params.retry;
    data.expire = params.expire;
}

data = JSON.stringify(data);
Zabbix.log(4, '[ Pushover Webhook ] Sending request: ' + params.endpoint + '\n' + data);

request.addHeader('Content-Type: application/json');
response = request.post(params.endpoint, data);

Zabbix.log(4, '[ Pushover Webhook ] Received response with status code ' + request.getStatus());

if (response !== null) {
    try {
        response = JSON.parse(response);
    }
    catch (error) {
        Zabbix.log(4, '[ Pushover Webhook ] Failed to parse response received from Pushover');
        response = null;
    }
}

if (request.getStatus() != 200 || response === null || typeof response !== 'object' || response
    if (response !== null && typeof response === 'object' && typeof response.errors === 'object'
        && typeof response.errors[0] === 'string') {
        throw response.errors[0];
    }
    else {
        throw 'Unknown error. Check debug log for more information.';
    }
}

return 'OK';
}
catch (error) {
    Zabbix.log(4, '[ Pushover Webhook ] Pushover notification failed: ' + error);
    throw 'Pushover notification failed: ' + error;
}
description: |
    Please refer to setup guide here: https://git.zabbix.com/projects/ZBX/repos/zabbix/browse/template

    Set token parameter with to your Pushover application key.
    When assigning Pushover media to the Zabbix user - add user key into send to field.
message_templates:
- event_source: TRIGGERS
  operation_mode: PROBLEM

```

```

subject: 'Problem: {EVENT.NAME}'
message: |
  Problem started at {EVENT.TIME} on {EVENT.DATE}
  Problem name: {EVENT.NAME}
  Host: {HOST.NAME}
  Severity: {EVENT.SEVERITY}
  Operational data: {EVENT.OPDATA}
  Original problem ID: {EVENT.ID}
  {TRIGGER.URL}
- event_source: TRIGGERS
operation_mode: RECOVERY
subject: 'Resolved in {EVENT.DURATION}: {EVENT.NAME}'
message: |
  Problem has been resolved at {EVENT.RECOVERY.TIME} on {EVENT.RECOVERY.DATE}
  Problem name: {EVENT.NAME}
  Problem duration: {EVENT.DURATION}
  Host: {HOST.NAME}
  Severity: {EVENT.SEVERITY}
  Original problem ID: {EVENT.ID}
  {TRIGGER.URL}
- event_source: TRIGGERS
operation_mode: UPDATE
subject: 'Updated problem in {EVENT.AGE}: {EVENT.NAME}'
message: |
  {USER.FULLNAME} {EVENT.UPDATE.ACTION} problem at {EVENT.UPDATE.DATE} {EVENT.UPDATE.TIME}.
  {EVENT.UPDATE.MESSAGE}

  Current problem status is {EVENT.STATUS}, age is {EVENT.AGE}, acknowledged: {EVENT.ACK.STATUS}
- event_source: DISCOVERY
operation_mode: PROBLEM
subject: 'Discovery: {DISCOVERY.DEVICE.STATUS} {DISCOVERY.DEVICE.IPADDRESS}'
message: |
  Discovery rule: {DISCOVERY.RULE.NAME}

  Device IP: {DISCOVERY.DEVICE.IPADDRESS}
  Device DNS: {DISCOVERY.DEVICE.DNS}
  Device status: {DISCOVERY.DEVICE.STATUS}
  Device uptime: {DISCOVERY.DEVICE.UPTIME}

  Device service name: {DISCOVERY.SERVICE.NAME}
  Device service port: {DISCOVERY.SERVICE.PORT}
  Device service status: {DISCOVERY.SERVICE.STATUS}
  Device service uptime: {DISCOVERY.SERVICE.UPTIME}
- event_source: AUTOREGISTRATION
operation_mode: PROBLEM
subject: 'Autoregistration: {HOST.HOST}'
message: |
  Host name: {HOST.HOST}
  Host IP: {HOST.IP}
  Agent port: {HOST.PORT}

```

Exported elements

Exported elements are explained in the table below.

Element	Type	Description
name	string	(required) Media type name.
type	string	(required) Transport used by the media type. Possible values: ¹ EMAIL (0), SMS (1), SCRIPT (2), WEBHOOK (4).
status	string	Whether the media type is enabled. Possible values: ¹ ENABLED (0, default), DISABLED (1)

Element	Type	Description
max_sessions	integer	The maximum number of alerts that can be processed in parallel. Possible values for SMS: ¹ 1 (default). Possible values for other media types: ¹ 0-100 (where 0 - unlimited).
attempts	integer	The maximum number of attempts to send an alert. Possible values: ¹ 1-10 (default: 3).
attempt_interval	string	The interval (using seconds or time suffix) between retry attempts. Possible values: ¹ 0-60s (default: 10s).
description	string	Media type description.
message_templates		Root element for media type message templates.
event_source	string	(required) Event source. Possible values: ¹ TRIGGERS (0), DISCOVERY (1), AUTOREGISTRATION (2), INTERNAL (3), SERVICE (4).
operation_mode	string	Operation mode. Possible values: ¹ PROBLEM (0), RECOVERY (1), UPDATE (2).
subject	string	Message subject.
message	string	Message body.

Note:

See also: **Media type object** (refer to the relevant property with a matching name).

Email

The following additional elements are exported only for the *Email* media type.

Element	Type	Description
provider	string	Email provider.
smtp_server	string	SMTP server.
smtp_port	integer	SMTP server port to connect to. Default: 25.
smtp_helo	string	SMTP helo.
smtp_email	string	Email address from which notifications will be sent.
smtp_security	string	SMTP connection security level to use. Possible values: ¹ NONE (0, default), STARTTLS (1), SSL_OR_TLS (2).
smtp_verify_host	string	SSL verify host for SMTP. Possible values: ¹ NO (0, default), YES (1).
smtp_verify_peer	string	SSL verify peer for SMTP. Possible values: ¹ NO (0, default), YES (1).
smtp_authentication	string	SMTP authentication method to use. Possible values: ¹ NONE (0, default), PASSWORD (1).
username	string	Username.
password	string	Authentication password.
message_format	string	Message format. Possible values: ¹ TEXT (0), HTML (1, default).

Note:

See also: **Media type object** (refer to the relevant property with a matching name).

SMS

The following additional elements are exported only for the *SMS* media type.

Element	Type	Description
gsm_modem	string	(required) Serial device name of the GSM modem.

Note:

See also: **Media type object** (refer to the relevant property with a matching name).

Script

The following additional elements are exported only for the *Script* media type.

Element	Type	Description
script name	string	(required) Script name.
parameters		Root element for script parameters.
sortorder	string	(required) Order of the script parameters passed to the script as command-line arguments.
value	string	Script parameter value.

Note:

See also: [Media type object](#) (refer to the relevant property with a matching name).

Webhook

The following additional elements are exported only for the *Webhook* media type.

Element	Type	Description
script	string	Script.
timeout	string	Javascript script HTTP request timeout interval. Possible values: ¹ 1-60s (default: 30s).
process_tags	string	Whether to process returned tags. Possible values: ¹ NO (0, default), YES (1).
show_event_menu	string	Indicates the presence of an entry in the event menu if the {EVENT.TAGS.*} macro was successfully resolved in event_menu_url and event_menu_name fields. Possible values: ¹ NO (0, default), YES (1).
event_menu_url	string	URL of the event menu entry. Supports {EVENT.TAGS.*} macro.
event_menu_name	string	Name of the event menu entry. Supports {EVENT.TAGS.*} macro.
parameters		Root element for webhook media type parameters.
name	string	(required) Webhook parameter name.
value	string	Webhook parameter value.

Note:

See also: [Media type object](#) (refer to the relevant property with a matching name).

Footnotes

¹ API integer values in brackets, for example, ENABLED (0), are mentioned only for reference. For more information, see the linked API object page in the table entry or at the end of each section.

15 Discovery

Please use the sidebar to access content in the Discovery section.

1 Network discovery

Overview

Zabbix offers automatic network discovery functionality that is effective and very flexible.

With network discovery properly set up you can:

- speed up Zabbix deployment
- simplify administration
- use Zabbix in rapidly changing environments without excessive administration

Zabbix network discovery is based on the following information:

- IP ranges
- Availability of external services (FTP, SSH, WEB, POP3, IMAP, TCP, etc)
- Information received from Zabbix agent (only unencrypted mode is supported)
- Information received from SNMP agent

It does NOT provide:

- Discovery of network topology

Network discovery basically consists of two phases: discovery and actions.

Discovery

Zabbix periodically scans the IP ranges defined in **network discovery rules**. The frequency of the check is configurable for each rule individually.

Each rule has a set of service checks defined to be performed for the IP range.

Discovery rules are processed by the discovery manager. The discovery manager creates a job per each rule with a list of tasks (network checks). Network checks are performed in parallel by the available discovery workers (the number is configurable in the frontend per each rule). Only checks with the same IP and port are scheduled sequentially because some devices will not accept parallel connections on the same port.

The queue size of network checks is limited to 2000000 or 4 GB of memory approximately. If the queue becomes full then the discovery rule will be skipped and a warning message will be printed in the log. You may use the `zabbix[discovery_queue]` internal item to monitor the number of discovery checks in the queue.

Discovery checks are processed independently from the other checks. If any checks do not find a service (or fail), other checks will still be processed.

Note:

If a discovery rule is changed during execution, then the current discovery execution will be aborted.

Every check of a service and a host (IP) performed by the network discovery module generates a discovery event.

Event	Check of service result
<i>Service Discovered</i>	The service is 'up' after it was 'down' or when discovered for the first time.
<i>Service Up</i>	The service is 'up', after it was already 'up'.
<i>Service Lost</i>	The service is 'down' after it was 'up'.
<i>Service Down</i>	The service is 'down', after it was already 'down'.
<i>Host Discovered</i>	At least one service of a host is 'up' after all services of that host were 'down' or a service is discovered which belongs to a not registered host.
<i>Host Up</i>	At least one service of a host is 'up', after at least one service was already 'up'.
<i>Host Lost</i>	All services of a host are 'down' after at least one was 'up'.
<i>Host Down</i>	All services of a host are 'down', after they were already 'down'.

Actions

Discovery events can be the basis of relevant **actions**, such as:

- Sending notifications
- Adding/removing hosts
- Enabling/disabling hosts
- Adding hosts to a group
- Removing hosts from a group
- Adding tags to a host
- Removing tags from a host
- Linking a template to hosts/unlinking a template from hosts
- Executing remote scripts

These actions can be configured with respect to the device type, IP, status, uptime/downtime, etc. For full details on configuring actions for network-discovery based events, see action **operation** and **conditions** pages.

Since network discovery actions are event-based, they will be triggered both when a discovered host is online and when it is offline. It is highly recommended to add an action **condition** `Discovery status: up` to avoid such actions as `Add host` being triggered upon

Service Lost/Service Down events. Otherwise, if a discovered host is manually removed, it will still generate *Service Lost/Service Down* events and will be recreated during the next discovery cycle.

Note:

Linking templates to a discovered host will fail collectively if any of the linkable templates has a unique entity (e.g. item key) that is the same as a unique entity (e.g. item key) already existing on the host or on another of the linkable templates.

Host creation

A host is added if the *Add host* operation is selected. A host is also added, even if the *Add host* operation is missing, if you select operations resulting in actions on a host. Such operations are:

- enable host
- disable host
- add host to a host group
- link template to a host

Created hosts are added to the *Discovered hosts* group (by default, configurable in *Administration* → *General* → *Other*). If you wish hosts to be added to another group, add a *Remove from host groups* operation (specifying "Discovered hosts") and also add an *Add to host groups* operation (specifying another host group), because a host must belong to a host group.

The IP address of the discovered device is the criterion for finding a host in the system. If a host with that IP address and interface type already exists, that host will be the target for performing operations.

If the IP address of the discovered host is changed or the interface is deleted, a new host will be created upon the next discovery.

Host naming

When adding hosts, a host name is the result of reverse DNS lookup or IP address if reverse lookup fails. Lookup is performed from the Zabbix server or Zabbix proxy, depending on which is doing the discovery. If lookup fails on the proxy, it is not retried on the server. If the host with such a name already exists, the next host would get *_2* appended to the name, then *_3* and so on.

It is also possible to override DNS/IP lookup and instead use an item value for host name, for example:

- You may discover multiple servers with Zabbix agent running using a Zabbix agent item for discovery and assign proper names to them automatically, based on the string value returned by this item
- You may discover multiple SNMP network devices using an SNMP agent item for discovery and assign proper names to them automatically, based on the string value returned by this item

If the host name has been set using an item value, it is not updated during the following discovery checks. If it is not possible to set host name using an item value, default value (DNS name) is used.

If a host already exists with the discovered IP address, a new host is not created. However, if the discovery action contains operations (link template, add to host group, etc), they are performed on the existing host.

Host removal

Hosts discovered by a network discovery rule are removed automatically from *Monitoring* → *Discovery* if a discovered entity is not in the rule's IP range any more. Hosts are removed immediately.

Interface creation when adding hosts

When hosts are added as a result of network discovery, they get interfaces created according to these rules:

- the services detected - for example, if an SNMP check succeeded, an SNMP interface will be created
- if a host responded both to Zabbix agent and SNMP requests, both types of interfaces will be created
- if uniqueness criteria are Zabbix agent or SNMP-returned data, the first interface found for a host will be created as the default one. Other IP addresses will be added as additional interfaces. Action's conditions (such as Host IP) do not impact adding interfaces. *Note* that this will work if all interfaces are discovered by the same discovery rule. If a different discovery rule discovers a different interface of the same host, an additional host will be added.
- if a host responded to agent checks only, it will be created with an agent interface only. If it would start responding to SNMP later, additional SNMP interfaces would be added.
- if 3 separate hosts were initially created, having been discovered by the "IP" uniqueness criteria, and then the discovery rule is modified so that hosts A, B and C have identical uniqueness criteria result, B and C are created as additional interfaces for A, the first host. The individual hosts B and C remain. In *Monitoring* → *Discovery* the added interfaces will be displayed in the "Discovered device" column, in black font and indented, but the "Monitored host" column will only display A, the first created host. "Uptime/Downtime" is not measured for IPs that are considered to be additional interfaces.

Changing proxy setting

The hosts discovered by different proxies are always treated as different hosts. While this allows to perform discovery on matching IP ranges used by different subnets, changing proxy for an already monitored subnet is complicated because the proxy changes must be also applied to all discovered hosts.

For example the steps to replace proxy in a discovery rule:

1. disable discovery rule
2. sync proxy configuration
3. replace the proxy in the discovery rule
4. replace the proxy for all hosts discovered by this rule
5. enable discovery rule

1 Configuring a network discovery rule

Overview

To configure a network discovery rule used by Zabbix to discover hosts and services:

- Go to *Data collection* → *Discovery*
- Click on *Create discovery rule* (or on the rule name to edit an existing one)
- Edit the discovery rule attributes

Rule attributes

New discovery rule
? X

* Name

Discovery by Server Proxy

* IP range

* Update interval

Maximum concurrent checks per type One Unlimited Custom 999

* Checks

Type	Actions
HTTP	Edit Remove
HTTPS	Edit Remove
Zabbix agent "system.uname"	Edit Remove
SNMPv2 agent "1.3.6.1.2.1.1.1.0"	Edit Remove
Add	

Device uniqueness criteria

IP address

Zabbix agent "system.uname"

SNMPv2 agent "1.3.6.1.2.1.1.1.0"

Host name

DNS name

IP address

Zabbix agent "system.uname"

SNMPv2 agent "1.3.6.1.2.1.1.1.0"

Visible name

Host name

DNS name

IP address

Zabbix agent "system.uname"

SNMPv2 agent "1.3.6.1.2.1.1.1.0"

Enabled

Add
Cancel

All mandatory input fields are marked with a red asterisk.

Parameter	Description
<i>Name</i>	Unique name of the rule. For example, "Local network".
<i>Discovery by</i>	Discovery is performed by: Server - by Zabbix server Proxy - by Zabbix proxy (selected in the proxy name field)
<i>IP range</i>	The range of IP addresses for discovery. It may have the following formats: Single IP: 192.168.1.33 Range of IP addresses: 192.168.1-10.1-255. The range is limited by the total number of covered addresses (less than 64K). IP mask: 192.168.4.0/24 supported IP masks: /16 - /30 for IPv4 addresses /112 - /128 for IPv6 addresses List: 192.168.1.1-255, 192.168.2.1-100, 192.168.2.200, 192.168.4.0/24 This field supports spaces, tabulation and multiple lines.

Parameter	Description
<i>Update interval</i>	<p>This parameter defines how often Zabbix will execute the rule. The interval is measured after the execution of previous discovery instance ends so there is no overlap.</p> <p>Time suffixes are supported, e.g. 30s, 1m, 2h, 1d. User macros are supported.</p> <p><i>Note</i> that if a user macro is used and its value is changed (e.g. 1w → 1h), the next check will be executed according to the previous value (far in the future with the example values).</p>
<i>Maximum concurrent checks per type</i>	<p>Set the maximum number of discovery threads (workers) per service check for parallel processing of discovery checks:</p> <p>One - one thread Unlimited - unlimited number of threads (but no more than in the StartDiscoverers parameter) Custom - set a custom number of threads (0-999)</p> <p><i>Note</i> that all discovery rules with SNMPv3 asynchronous service checks are processed by one worker due to the peculiarities of libsnmp implementation, i.e. increasing the number of workers will not increase the discovery speed.</p>
<i>Checks</i>	<p>Zabbix will use this list of checks for discovery. Click on Add to configure a new check in a popup window.</p> <p>Supported checks: SSH, LDAP, SMTP, FTP, HTTP, HTTPS, POP, NNTP, IMAP, TCP, Telnet, Zabbix agent, SNMPv1 agent, SNMPv2 agent, SNMPv3 agent, ICMP ping.</p> <p>A protocol-based discovery uses the net.tcp.service[] functionality to test each host, except for SNMP which queries an SNMP OID. Zabbix agent is tested by querying an item in unencrypted mode. Please see agent items for more details.</p> <p>The 'Ports' parameter may be one of following: Single port: 22 Range of ports: 22-45 List: 22-45,55,60-70</p> <p>Since Zabbix 7.0. all service checks are performed asynchronously, except for LDAP checks. Since Zabbix 7.0 HTTP/HTTPS checking is done via libcurl. If Zabbix server/proxy is compiled without libcurl, then HTTP checks will work like in previous versions (i.e. as TCP checks), but HTTPS checks will not work.</p>
<i>Device uniqueness criteria</i>	<p>Uniqueness criteria may be:</p> <p>IP address - do not process multiple single-IP devices. If a device with the same IP already exists it will be considered already discovered and a new host will not be added.</p> <p><discovery check> - either Zabbix agent or SNMP agent check.</p> <p><i>Note</i> that uniqueness criteria used during discovery is not the same as host identification in the system when performing actions. Uniqueness criteria during discovery define whether two or more discovered devices are the same (or different), whereas only the IP address is the criterion for host identification in Zabbix (see Host creation).</p>
<i>Host name</i>	<p>Set the technical host name of a created host using:</p> <p>DNS name - DNS name (default) IP address - IP address <discovery check> - received string value of the discovery check (e.g. Zabbix agent, SNMP agent check)</p> <p>See also: Host naming.</p>
<i>Visible name</i>	<p>Set the visible host name of a created host using:</p> <p>Host name - technical host name (default) DNS name - DNS name IP address - IP address <discovery check> - received string value of the discovery check (e.g. Zabbix agent, SNMP agent check)</p> <p>See also: Host naming.</p>
<i>Enabled</i>	<p>With the check-box marked the rule is active and will be executed by Zabbix server. If unmarked, the rule is not active. It won't be executed.</p>

Exceeding file descriptor limit

In case of large number of concurrent checks, it is possible to exhaust the file descriptor limit for the [discovery manager](#).

The number of file descriptors required for detection equates to the number of discovery workers * 1000. By default, there are 5 [discovery workers](#), while the soft limit of the system is approximately 1024.

If this limit is approached, Zabbix will reduce the default number of concurrent checks per type for each worker and write a warning

to the log file. But, if the user has set a higher value for *Maximum concurrent checks per type* than the value calculated by Zabbix, Zabbix will use the user-defined value for one worker.

A real life scenario

In this example, we would like to set up network discovery for the local network having an IP range of 192.168.1.1-192.168.1.254.

In our scenario we want to:

- discover those hosts that have Zabbix agent running
- run discovery every 10 minutes
- add a host to monitoring if the host uptime is more than 1 hour
- remove hosts if the host downtime is more than 24 hours
- add Linux hosts to the "Linux servers" group
- add Windows hosts to the "Windows servers" group
- use the template *Linux* for Linux hosts
- use the template *Windows* for Windows hosts

Step 1

Defining a network discovery rule for our IP range.

New discovery rule ? X

* Name

Discovery by

* IP range

* Update interval

Maximum concurrent checks per type

* Checks

Type	Actions
Zabbix agent "system.uname"	Edit Remove
Add	

Device uniqueness criteria IP address Zabbix agent "system.uname"

Host name DNS name IP address Zabbix agent "system.uname"

Visible name Host name DNS name IP address Zabbix agent "system.uname"

Enabled

Zabbix will try to discover hosts in the IP range of 192.168.1.1-192.168.1.254 by connecting to Zabbix agents and getting the value from the **system.uname** key. The value received from the agent can be used to name the hosts and also to apply different actions for different operating systems. For example, link Windows servers to the template *Windows*, Linux servers to the template *Linux*.

The rule will be executed every 10 minutes.

When this rule is added, Zabbix will automatically start the discovery and generation of the discovery-based events for further processing.

Step 2

Defining a discovery **action** for adding the discovered Linux servers to the respective group/template.

The screenshot shows the 'Action' configuration page in Zabbix. The 'Operations' tab is selected. The configuration includes:

- Name:** Add discovered Linux servers
- Type of calculation:** And (with a dropdown arrow) A and B and C and D
- Conditions:** A table with 2 columns: Label and Name.
 - A: Received value contains *Linux*
 - B: Discovery status equals *Up*
 - C: Service type equals *Zabbix agent*
 - D: Uptime/Downtime is greater than or equals *3600*
- Add:** A blue link to add more conditions.

The action will be activated if:

- the "Zabbix agent" service is "up"
- the value of system.uname (the Zabbix agent key we used in rule definition) contains "Linux"
- Uptime is 1 hour (3600 seconds) or more

The screenshot shows the 'Action' configuration page in Zabbix, continuing from the previous one. The 'Operations' tab is selected. The configuration includes:

- Default subject:** Discovery: {DISCOVERY.DEVICE.STATUS}, {DISCOVERY.DEVICE.IPADDRESS}
- Default message:** Discovery rule: {DISCOVERY.RULE.NAME}
Device IP: {DISCOVERY.DEVICE.IPADDRESS}
Device DNS: {DISCOVERY.DEVICE.DNS}
Device status: {DISCOVERY.DEVICE.STATUS}
Device uptime: {DISCOVERY.DEVICE.UPTIME}
Device service name: {DISCOVERY.SERVICE.NAME}
- Operations:** A table with 2 columns: Details and Action.
 - Add to host groups:** Linux servers
 - Link to templates:** Linux
- Add:** A blue link to add more operations.

The action will execute the following operations:

- add the discovered host to the "Linux servers" group (and also add host if it wasn't added previously)
- link host to the *Linux* template. Zabbix will automatically start monitoring the host using items and triggers from the "Linux" template.

Step 3

Defining a discovery action for adding the discovered Windows servers to the respective group/template.

Action Operations

* Name

Type of calculation A and B and C and D

Conditions

Label	Name
A	Received value contains <i>Windows</i>
B	Discovery status equals <i>Up</i>
C	Service type equals <i>Zabbix agent</i>
D	Uptime/Downtime is greater than or equals <i>3600</i>

[Add](#)

Action Operations

Default subject

Default message

Operations

Details

Add to host groups: Windows servers

Link to templates: Windows

[Add](#)

Step 4

Defining a discovery action for removing lost servers.

Action Operations

* Name

Type of calculation A and B and C

Conditions

Label	Name
A	Uptime/Downtime is greater than or equals 86400
B	Discovery status equals Down
C	Service type equals Zabbix agent

[Add](#)

Action Operations

Default subject

Default message
 Device IP: {DISCOVERY.DEVICE.IPADDRESS}
 Device DNS: {DISCOVERY.DEVICE.DNS}
 Device status: {DISCOVERY.DEVICE.STATUS}
 Device uptime: {DISCOVERY.DEVICE.UPTIME}
 Device service name: {DISCOVERY.SERVICE.NAME}

Operations

Details	Action
Remove host	Edit Remove

[Add](#)

A server will be removed if "Zabbix agent" service is 'down' for more than 24 hours (86400 seconds).

2 Active agent autoregistration

Overview

It is possible to allow active Zabbix agent autoregistration, after which the server can start monitoring them. This way new hosts can be added for monitoring without configuring them manually on the server.

Autoregistration can happen when a previously unknown active agent asks for checks.

The feature might be very handy for automatic monitoring of new Cloud nodes. As soon as you have a new node in the Cloud Zabbix will automatically start the collection of performance and availability data of the host.

Active agent autoregistration also supports the monitoring of added hosts with passive checks. When the active agent asks for checks, providing it has the 'ListenIP' or 'ListenPort' configuration parameters defined in the configuration file, these are sent along to the server. (If multiple IP addresses are specified, the first one is sent to the server.)

Server, when adding the new autoregistered host, uses the received IP address and port to configure the agent. If no IP address value is received, the one used for the incoming connection is used. If no port value is received, 10050 is used.

It is possible to specify that the host should be autoregistered with a **DNS name** as the default agent interface.

Autoregistration is rerun:

- if host **metadata** information changes:
 - due to HostMetadata changed and agent restarted
 - due to value returned by HostMetadataItem changed
- for manually created hosts with metadata missing
- if a host is manually changed to be monitored by another Zabbix proxy
- if autoregistration for the same host comes from a new Zabbix proxy

The active agent autoregistration heartbeat for Zabbix server and Zabbix proxy is 120 seconds. So in case a discovered host is deleted, the autoregistration will be rerun in 120 seconds.

Configuration

Specify server

Make sure you have the Zabbix server identified in the agent **configuration file** - `zabbix_agentd.conf`

```
ServerActive=10.0.0.1
```

Unless you specifically define a *Hostname* in `zabbix_agentd.conf`, the system hostname of agent location will be used by server for naming the host. The system hostname in Linux can be obtained by running the 'hostname' command.

If *Hostname* is defined in Zabbix agent configuration as a comma-delimited list of hosts, hosts will be created for all listed hostnames.

Restart the agent after making any changes to the configuration file.

Action for active agent autoregistration

When server receives an autoregistration request from an agent it calls an **action**. An action of event source "Autoregistration" must be configured for agent autoregistration.

Note:

Setting up **network discovery** is not required to have active agents autoregister.

In the Zabbix frontend, go to *Alerts* → *Actions*, select *Autoregistration actions* and click on *Create action*:

- In the Action tab, give your action a name
- Optionally specify **conditions**. You can do a substring match or regular expression match in the conditions for host name/host metadata. If you are going to use the "Host metadata" condition, see the next section.
- In the Operations tab, add relevant operations, such as - 'Add host', 'Add to host group' (for example, *Discovered hosts*), 'Link templates', etc.

Note:

If the hosts that will be autoregistering are likely to be supported for active monitoring only (such as hosts that are firewalled from your Zabbix server) then you might want to create a specific template like *Template_Linux-active* to link to.

Created hosts are added to the *Discovered hosts* group (by default, configurable in *Administration* → *General* → *Other*). If you wish hosts to be added to another group, add a *Remove from host group* operation (specifying "Discovered hosts") and also add an *Add to host group* operation (specifying another host group), because a host must belong to a host group.

Secure autoregistration

A secure way of autoregistration is possible by configuring PSK-based authentication with encrypted connections.

The level of encryption is configured globally in *Administration* → *General* → *Autoregistration*. It is possible to select no encryption, TLS encryption with PSK authentication or both (so that some hosts may register without encryption while others through encryption).

Authentication by PSK is verified by Zabbix server before adding a host. If successful, the host is added and *Connections from/to host* are set to 'PSK' only with identity/pre-shared key the same as in the global autoregistration setting.

Attention:

To ensure security of autoregistration on installations using proxies, encryption between Zabbix server and proxy should be enabled.

Using DNS as default interface

HostInterface and HostInterfaceItem **configuration parameters** allow to specify a custom value for the host interface during autoregistration.

More specifically, they are useful if the host should be autoregistered with a DNS name as the default agent interface rather than its IP address. In that case the DNS name should be specified or returned as the value of either `HostInterface` or `HostInterfaceItem` parameters. Note that if the value of one of the two parameters changes, the autoregistered host interface is updated. So it is possible to update the default interface to another DNS name or update it to an IP address. For the changes to take effect though, the agent has to be restarted.

Note:

If `HostInterface` or `HostInterfaceItem` parameters are not configured, the `listen_dns` parameter is resolved from the IP address. If such resolving is configured incorrectly, it may break autoregistration because of invalid hostname.

Using host metadata

When agent is sending an autoregistration request to the server it sends its hostname. In some cases (for example, Amazon cloud nodes) a hostname is not enough for Zabbix server to differentiate discovered hosts. Host metadata can be optionally used to send other information from an agent to the server.

Host metadata is configured in the agent **configuration file** - `zabbix_agentd.conf`. There are 2 ways of specifying host metadata in the configuration file:

`HostMetadata`

`HostMetadataItem`

See the description of the options in the link above.

The `HostMetadataItem` parameter may return up to 65535 UTF-8 code points. A longer value will be truncated.

Note that on MySQL, the effective maximum length in characters will be less if the returned value contains multibyte characters. For example, a value containing 3-byte characters only will be limited to 21844 characters in total, while a value containing 4-byte characters only will be limited to 16383 symbols.

Attention:

An autoregistration attempt happens every time an active agent sends a request to refresh active checks to the server. The delay between requests is specified in the `RefreshActiveChecks` parameter of the agent. The first request is sent immediately after the agent is restarted.

Example 1

Using host metadata to distinguish between Linux and Windows hosts.

Say you would like the hosts to be autoregistered by the Zabbix server. You have active Zabbix agents (see "Configuration" section above) on your network. There are Windows hosts and Linux hosts on your network and you have "Linux by Zabbix agent" and "Windows by Zabbix agent" templates available in your Zabbix frontend. So at host registration, you would like the appropriate Linux/Windows template to be applied to the host being registered. By default, only the hostname is sent to the server at autoregistration, which might not be enough. In order to make sure the proper template is applied to the host you should use host metadata.

Frontend configuration

The first thing to do is to configure the frontend. Create 2 actions. The first action:

- Name: Linux host autoregistration
- Conditions: Host metadata contains *Linux*
- Operations: Link templates: Linux

Note:

You can skip an "Add host" operation in this case. Linking a template to a host requires adding the host first so the server will do that automatically.

The second action:

- Name: Windows host autoregistration
- Conditions: Host metadata contains *Windows*
- Operations: Link templates: Windows

Agent configuration

Now you need to configure the agents. Add the next line to the agent configuration files:

```
HostMetadataItem=system.uname
```

This way you make sure host metadata will contain "Linux" or "Windows" depending on the host an agent is running on. An example of host metadata in this case:

Linux: Linux server3 3.2.0-4-686-pae #1 SMP Debian 3.2.41-2 i686 GNU/Linux

Windows: Windows WIN-OPXGGSTYNHO 6.0.6001 Windows Server 2008 Service Pack 1 Intel IA-32

Do not forget to restart the agent after making any changes to the configuration file.

Example 2

Step 1

Using host metadata to allow some basic protection against unwanted hosts registering.

Frontend configuration

Create an action in the frontend, using some hard-to-guess secret code to disallow unwanted hosts:

- Name: Autoregistration action Linux
- Conditions:
 - Type of calculation: AND
 - Condition (A): Host metadata contains //Linux//
 - Condition (B): Host metadata contains //21df83bf21bf0be663090bb8d4128558ab9b95fba66a6dbf834f8b91ae5e08ae//
- Operations:
 - Send message to users: Admin via all media
 - Add to host groups: Linux servers
 - Link templates: Linux

Please note that this method alone does not provide strong protection because data is transmitted in plain text. Configuration cache reload is required for changes to have an immediate effect.

Agent configuration

Add the next line to the agent configuration file:

```
HostMetadata=Linux 21df83bf21bf0be663090bb8d4128558ab9b95fba66a6dbf834f8b91ae5e08ae
```

where "Linux" is a platform, and the rest of the string is the hard-to-guess secret text.

Do not forget to restart the agent after making any changes to the configuration file.

Step 2

It is possible to add additional monitoring for an already registered host.

Frontend configuration

Update the action in the frontend:

- Name: Autoregistration action Linux
- Conditions:
 - Type of calculation: AND
 - Condition (A): Host metadata contains Linux
 - Condition (B): Host metadata contains 21df83bf21bf0be663090bb8d4128558ab9b95fba66a6dbf834f8b91ae5e08ae
- Operations:
 - Send message to users: Admin via all media
 - Add to host groups: Linux servers
 - Link templates: Linux
 - Link templates: MySQL by Zabbix Agent

Agent configuration

Update the next line in the agent configuration file:

```
HostMetadata=MySQL on Linux 21df83bf21bf0be663090bb8d4128558ab9b95fba66a6dbf834f8b91ae5e08ae
```

Do not forget to restart the agent after making any changes to the configuration file.

3 Low-level discovery

Overview Low-level discovery provides a way to automatically create items, triggers, and graphs for different entities on a computer. For instance, Zabbix can automatically start monitoring file systems or network interfaces on your machine, without the need to create items for each file system or network interface manually. Additionally, it is possible to configure Zabbix to remove unneeded entities automatically based on the actual results of periodically performed discovery.

A user can define their own types of discovery, provided they follow a particular JSON protocol.

The general architecture of the discovery process is as follows.

First, a user creates a discovery rule in *Data collection* → *Templates*, in the *Discovery* column. A discovery rule consists of (1) an item that discovers the necessary entities (for instance, file systems or network interfaces) and (2) prototypes of items, triggers, and graphs that should be created based on the value of that item.

An item that discovers the necessary entities is like a regular item seen elsewhere: the server asks a Zabbix agent (or whatever the type of the item is set to) for a value of that item, the agent responds with a textual value. The difference is that the value the agent responds with should contain a list of discovered entities in a JSON format. While the details of this format are only important for implementers of custom discovery checks, it is necessary to know that the returned value contains a list of macro → value pairs. For instance, item "net.if.discovery" might return two pairs: "{#IFNAME}" → "lo" and "{#IFNAME}" → "eth0".

These macros are used in names, keys and other prototype fields where they are then substituted with the received values for creating real items, triggers, graphs or even hosts for each discovered entity. See the full list of [options](#) for using LLD macros.

When the server receives a value for a discovery item, it looks at the macro → value pairs and for each pair generates real items, triggers, and graphs, based on their prototypes. In the example with "net.if.discovery" above, the server would generate one set of items, triggers, and graphs for the loopback interface "lo", and another set for interface "eth0".

Note that since **Zabbix 4.2**, the format of the JSON returned by low-level discovery rules has been changed. It is no longer expected that the JSON will contain the "data" object. Low-level discovery will now accept a normal JSON containing an array, in order to support new features such as the item value preprocessing and custom paths to low-level discovery macro values in a JSON document.

Built-in discovery keys have been updated to return an array of LLD rows at the root of JSON document. Zabbix will automatically extract a macro and value if an array field uses the {#MACRO} syntax as a key. Any new native discovery checks will use the new syntax without the "data" elements. When processing a low-level discovery value first the root is located (array at \$. or \$.data).

While the "data" element has been removed from all native items related to discovery, for backward compatibility Zabbix will still accept the JSON notation with a "data" element, though its use is discouraged. If the JSON contains an object with only one "data" array element, then it will automatically extract the content of the element using JSONPath \$.data. Low-level discovery now accepts optional user-defined LLD macros with a custom path specified in JSONPath syntax.

Warning:

As a result of the changes above, newer agents no longer will be able to work with an older Zabbix server.

See also: [Discovered entities](#)

Configuring low-level discovery We will illustrate low-level discovery based on an example of file system discovery.

To configure the discovery, do the following:

- Go to: *Data collection* → *Templates* or *Hosts*
- Click on *Discovery* in the row of an appropriate template/host

≡ Templates

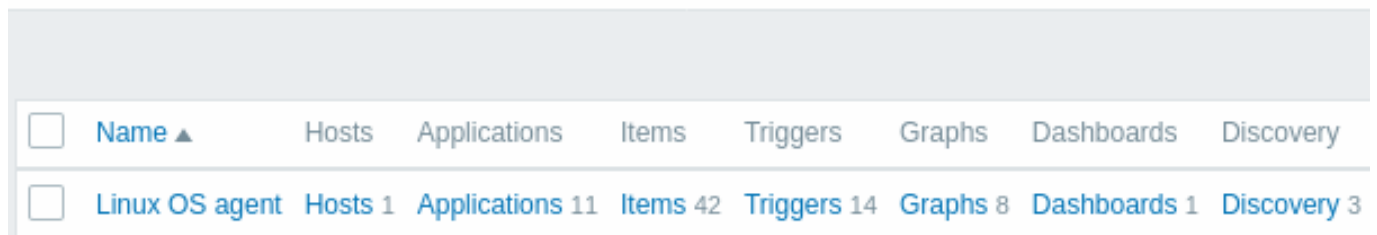

- Click on *Create discovery rule* in the upper right corner of the screen
- Fill in the discovery rule form with the required details

Discovery rule

The discovery rule form contains five tabs, representing, from left to right, the data flow during discovery:

- *Discovery rule* - specifies, most importantly, the built-in item or custom script to retrieve discovery data
- *Preprocessing* - applies some preprocessing to the discovered data
- *LLD macros* - allows to extract some macro values to use in discovered items, triggers, etc
- *Filters* - allows to filter the discovered values
- *Overrides* - allows to modify items, triggers, graphs or host prototypes when applying to specific discovered objects

The **Discovery rule** tab contains the item key to use for discovery (as well as some general discovery rule attributes):

All mandatory input fields are marked with a red asterisk.

Parameter	Description
<i>Name</i>	Name of discovery rule.
<i>Type</i>	The type of check to perform discovery. In this example we are using a <i>Zabbix agent</i> item type. The discovery rule can also be a dependent item , depending on a regular item. It cannot depend on another discovery rule. For a dependent item, select the respective type (<i>Dependent item</i>) and specify the master item in the 'Master item' field. The master item must exist.
<i>Key</i>	Enter the discovery item key (up to 2048 characters). For example, you may use the built-in "vfs.fs.discovery" item key to return a JSON with the list of file systems present on the computer, their types and mount options. Note that another option for filesystem discovery is using discovery results by the "vfs.fs.get" agent key (see example).

Parameter	Description
<i>Update interval</i>	<p>This field specifies how often Zabbix performs discovery. In the beginning, when you are just setting up file system discovery, you might wish to set it to a small interval, but once you know it works you can set it to 30 minutes or more, because file systems usually do not change very often.</p> <p>Time suffixes are supported, e.g. 30s, 1m, 2h, 1d.</p> <p>User macros are supported.</p> <p><i>Note:</i> The update interval can only be set to '0' if custom intervals exist with a non-zero value. If set to '0', and a custom interval (flexible or scheduled) exists with a non-zero value, the item will be polled during the custom interval duration.</p> <p>New discovery rules will be checked within 60 seconds of their creation, unless they have Scheduling or Flexible update interval and the <i>Update interval</i> is set to 0.</p> <p><i>Note</i> that for an existing discovery rule the discovery can be performed immediately by pushing the <i>Execute now</i> button.</p>
<i>Custom intervals</i>	<p>You can create custom rules for checking the item:</p> <p>Flexible - create an exception to the <i>Update interval</i> (interval with different frequency)</p> <p>Scheduling - create a custom polling schedule.</p> <p>For detailed information see Custom intervals.</p>
<i>Timeout</i>	<p>Set the discovery check timeout. Select the timeout option:</p> <p>Global - proxy/global timeout is used (displayed in the grayed out <i>Timeout</i> field);</p> <p>Override - custom timeout is used (set in the <i>Timeout</i> field; allowed range: 1 - 600s). Time suffixes, e.g. 30s, 1m, and user macros are supported.</p> <p>Clicking the <i>Timeouts</i> link allows you to configure proxy timeouts or global timeouts (if a proxy is not used). Note that the <i>Timeouts</i> link is visible only to users of <i>Super admin</i> type with permissions to <i>Administration</i> → General or <i>Administration</i> → Proxies frontend sections.</p>
<i>Delete lost resources</i>	<p>Specify how soon the discovered entity will be deleted once its discovery status becomes "Not discovered anymore":</p> <p><i>Never</i> - it will not be deleted;</p> <p><i>Immediately</i> - it will be deleted immediately;</p> <p><i>After</i> - it will be deleted after the specified time period. The value must be greater than <i>Disable lost resources</i> value.</p> <p>Time suffixes are supported, e.g. 2h, 1d.</p> <p>User macros are supported.</p> <p><i>Note:</i> Using "Immediately" is not recommended, since just wrongly editing the filter may end up in the entity being deleted with all the historical data.</p> <p>Note that manually disabled resources will not be deleted by low-level discovery.</p>
<i>Disable lost resources</i>	<p>Specify how soon the discovered entity will be disabled once its discovery status becomes "Not discovered anymore":</p> <p><i>Never</i> - it will not be disabled;</p> <p><i>Immediately</i> - it will be disabled immediately;</p> <p><i>After</i> - it will be disabled after the specified time period. The value should be greater than the discovery rule update interval.</p> <p>Note that automatically disabled resources will become enabled again, if re-discovered by low-level discovery. Manually disabled resources will not become enabled again if re-discovered. This field is not displayed if <i>Delete lost resources</i> is set to "Immediately".</p> <p>Time suffixes are supported, e.g. 2h, 1d.</p> <p>User macros are supported.</p>
<i>Description</i>	Enter a description.
<i>Enabled</i>	If checked, the rule will be processed.

Note:

Discovery rule history is not preserved.

Preprocessing

The **Preprocessing** tab allows to define transformation rules to apply to the result of discovery. One or several transformations are possible in this step. Transformations are executed in the order in which they are defined. All preprocessing is done by Zabbix server.

See also:

- [Preprocessing details](#)

- Preprocessing testing

Discovery rule **Preprocessing 2** LLD macros Filters Overrides

Preprocessing steps	Name	Parameters
1:	Regular expression	pattern
2:	JSONPath	\$.pool

[Add](#)

Type	Transformation	Description
Text	<i>Regular expression</i>	Match the received value to the <pattern> regular expression and replace value with the extracted <output>. The regular expression supports extraction of maximum 10 captured groups with the \N sequence. Parameters: pattern - regular expression output - output formatting template. An \N (where N=1..9) escape sequence is replaced with the Nth matched group. A \0 escape sequence is replaced with the matched text. If you mark the <i>Custom on fail</i> checkbox, it is possible to specify custom error-handling options: either to discard the value, set a specified value or set a specified error message.
	<i>Replace</i>	Find the search string and replace it with another (or nothing). All occurrences of the search string will be replaced. Parameters: search string - the string to find and replace, case-sensitive (required) replacement - the string to replace the search string with. The replacement string may also be empty effectively allowing to delete the search string when found. It is possible to use escape sequences to search for or replace line breaks, carriage return, tabs and spaces "\n \r \t \s"; backslash can be escaped as "\\" and escape sequences can be escaped as "\\n". Escaping of line breaks, carriage return, tabs is automatically done during low-level discovery.
Structured data	<i>JSONPath</i>	Extract value or fragment from JSON data using JSONPath functionality . If you mark the <i>Custom on fail</i> checkbox, it is possible to specify custom error-handling options: either to discard the value, set a specified value or set a specified error message.
	<i>XML XPath</i>	Extract value or fragment from XML data using XPath functionality. For this option to work, Zabbix server must be compiled with libxml support. Examples: number(/document/item/value) will extract 10 from <document><item><value>10</value></item></document> number(/document/item/@attribute) will extract 10 from <document><item attribute="10"></item></document> /document/item will extract <item><value>10</value></item> from <document><item><value>10</value></item></document> Note that namespaces are not supported. If you mark the <i>Custom on fail</i> checkbox, it is possible to specify custom error-handling options: either to discard the value, set a specified value or set a specified error message.
	<i>CSV to JSON</i>	Convert CSV file data into JSON format. For more information, see: CSV to JSON preprocessing .
	<i>XML to JSON</i>	Convert data in XML format to JSON. For more information, see: Serialization rules . If you mark the <i>Custom on fail</i> checkbox, it is possible to specify custom error-handling options: either to discard the value, set a specified value or set a specified error message.
SNMP		

Type

<i>SNMP walk value</i>	<p>Extract value by the specified OID/MIB name and apply formatting options:</p> <p>Unchanged - return Hex-STRING as unescaped hex string;</p> <p>UTF-8 from Hex-STRING - convert Hex-STRING to UTF-8 string;</p> <p>MAC from Hex-STRING - convert Hex-STRING to MAC address string (which will have ' ' replaced by ':');</p> <p>Integer from BITS - convert the first 8 bytes of a bit string expressed as a sequence of hex characters (e.g. "1A 2B 3C 4D") into a 64-bit unsigned integer. In bit strings longer than 8 bytes, consequent bytes will be ignored.</p> <p>If you mark the <i>Custom on fail</i> checkbox, it is possible to specify custom error-handling options: either to discard the value, set a specified value or set a specified error message.</p>
<i>SNMP walk to JSON</i>	<p>Convert SNMP values to JSON. Specify a field name in the JSON and the corresponding SNMP OID path. Field values will be populated by values in the specified SNMP OID path.</p> <p>You may use this preprocessing step for SNMP OID discovery.</p> <p>Similar value formatting options as in the <i>SNMP walk value</i> step are available.</p> <p>If you mark the <i>Custom on fail</i> checkbox, it is possible to specify custom error-handling options: either to discard the value, set a specified value or set a specified error message.</p>
<i>SNMP get value</i>	<p>Apply formatting options to the SNMP get value:</p> <p>UTF-8 from Hex-STRING - convert Hex-STRING to UTF-8 string;</p> <p>MAC from Hex-STRING - convert Hex-STRING to MAC address string (which will have ' ' replaced by ':');</p> <p>Integer from BITS - convert the first 8 bytes of a bit string expressed as a sequence of hex characters (e.g. "1A 2B 3C 4D") into a 64-bit unsigned integer. In bit strings longer than 8 bytes, consequent bytes will be ignored.</p> <p>If you mark the <i>Custom on fail</i> checkbox, it is possible to specify custom error-handling options: either to discard the value, set a specified value or set a specified error message.</p>
Custom scripts	
<i>JavaScript</i>	<p>Enter JavaScript code in the modal editor that opens when clicking in the parameter field or on the pencil icon next to it.</p> <p>Note that available JavaScript length depends on the database used.</p> <p>For more information, see: Javascript preprocessing</p>
Validation	
<i>Does not match regular expression</i>	<p>Specify a regular expression that a value must not match.</p> <p>E.g. <code>Error: (. *?)\.</code></p> <p>If you mark the <i>Custom on fail</i> checkbox, it is possible to specify custom error-handling options: either to discard the value, set a specified value or set a specified error message.</p>
<i>Check for error in JSON</i>	<p>Check for an application-level error message located at JSONPath. Stop processing if succeeded and message is not empty; otherwise continue processing with the value that was before this preprocessing step. Note that these external service errors are reported to user as is, without adding preprocessing step information.</p> <p>E.g. <code>\$.errors</code>. If a JSON like <code>{"errors": "e1"}</code> is received, the next preprocessing step will not be executed.</p> <p>If you mark the <i>Custom on fail</i> checkbox, it is possible to specify custom error-handling options: either to discard the value, set a specified value or set a specified error message.</p>
<i>Check for error in XML</i>	<p>Check for an application-level error message located at Xpath. Stop processing if succeeded and message is not empty; otherwise continue processing with the value that was before this preprocessing step. Note that these external service errors are reported to user as is, without adding preprocessing step information.</p> <p>No error will be reported in case of failing to parse invalid XML.</p> <p>If you mark the <i>Custom on fail</i> checkbox, it is possible to specify custom error-handling options: either to discard the value, set a specified value or set a specified error message.</p>
<i>Matches regular expression</i>	<p>Specify a regular expression that a value must match.</p> <p>If you mark the <i>Custom on fail</i> checkbox, it is possible to specify custom error-handling options: either to discard the value, set a specified value or set a specified error message.</p>

Throttling

Type	
<i>Discard unchanged with heartbeat</i>	Discard a value if it has not changed within the defined time period (in seconds). Positive integer values are supported to specify the seconds (minimum - 1 second). Time suffixes can be used in this field (e.g. 30s, 1m, 2h, 1d). User macros and low-level discovery macros can be used in this field. Only one throttling option can be specified for a discovery item. E.g. 1m. If identical text is passed into this rule twice within 60 seconds, it will be discarded. <i>Note:</i> Changing item prototypes does not reset throttling. Throttling is reset only when preprocessing steps are changed.
Prometheus	
<i>Prometheus to JSON</i>	Convert required Prometheus metrics to JSON. See Prometheus checks for more details.

Note that if the discovery rule has been applied to the host via template then the content of this tab is read-only.

Custom macros

The **LLD macros** tab allows to specify custom low-level discovery macros.

Custom macros are useful in cases when the returned JSON does not have the required macros already defined. So, for example:

- The native `vfs.fs.discovery` key for filesystem discovery returns a JSON with some pre-defined LLD macros such as `{#FSNAME}`, `{#FSTYPE}`. These macros can be used in item, trigger prototypes (see subsequent sections of the page) directly; defining custom macros is not needed;
- The `vfs.fs.get` agent item also returns a JSON with [filesystem data](#), but without any pre-defined LLD macros. In this case you may define the macros yourself, and map them to the values in the JSON using JSONPath:

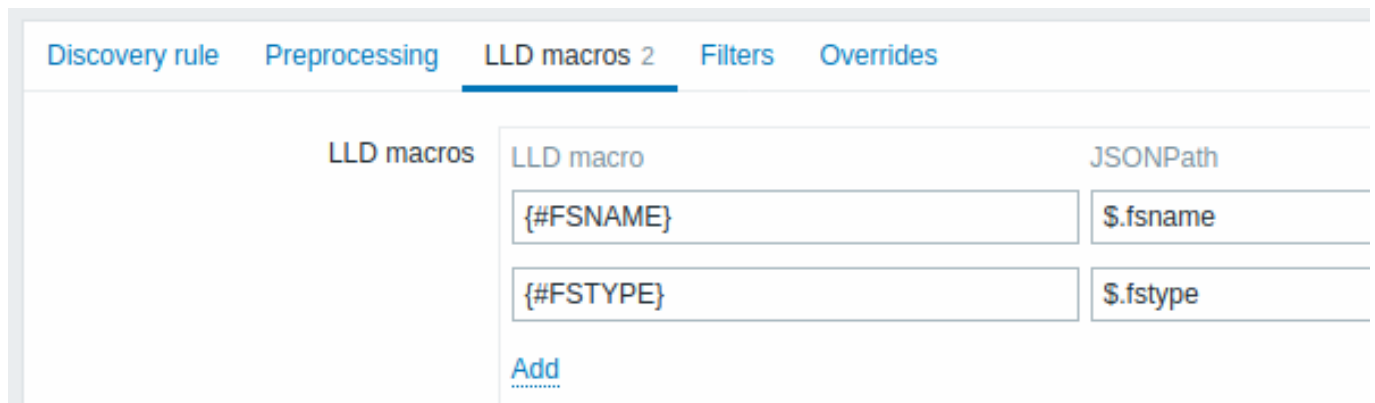

The extracted values can be used in discovered items, triggers, etc. Note that values will be extracted from the result of discovery and any preprocessing steps so far.

Parameter	Description
<i>LLD macro</i>	Name of the low-level discovery macro, using the following syntax: <code>{#MACRO}</code> .
<i>JSONPath</i>	Path that is used to extract LLD macro value from an LLD row, using JSONPath syntax. The values extracted from the returned JSON are used to replace the LLD macros in item, trigger, etc. prototype fields. JSONPath can be specified using the dot notation or the bracket notation. Bracket notation should be used in case of any special characters and Unicode, like <code>['unicode + special chars #1']['unicode + special chars #2']</code> . For example, <code>\$.foo</code> will extract "bar" and "baz" from this JSON: <code>[{"foo": "bar"}, {"foo": "baz"}]</code> Note that <code>\$.foo</code> will extract "bar" and "baz" also from this JSON: <code>{"data": [{"foo": "bar"}, {"foo": "baz"}]}</code> because a single "data" object is processed automatically (for backwards compatibility with the low-level discovery implementation in Zabbix versions before 4.2).

Filter

A filter can be used to generate real items, triggers, and graphs only for entities that match the criteria. The **Filters** tab contains discovery rule filter definitions allowing to filter discovery values:

Type of calculation (A and B) and (C and D)

Filters	Label	Macro		Regular expression
A	<input type="text" value="{#FSNAME}"/>	<input type="text" value="matches"/>	<input type="text" value=""/>	<input type="text" value="{\\$VFS.FS.FSNAME.MATCH"/>
B	<input type="text" value="{#FSNAME}"/>	<input type="text" value="does not match"/>	<input type="text" value=""/>	<input type="text" value="{\\$VFS.FS.FSNAME.NOT_M"/>
C	<input type="text" value="{#FSTYPE}"/>	<input type="text" value="matches"/>	<input type="text" value=""/>	<input type="text" value="{\\$VFS.FS.FSTYPE.MATCH"/>
D	<input type="text" value="{#FSTYPE}"/>	<input type="text" value="does not match"/>	<input type="text" value=""/>	<input type="text" value="{\\$VFS.FS.FSTYPE.NOT_M"/>

[Add](#)

Parameter	Description
Type of calculation	<p>The following options for calculating filters are available:</p> <ul style="list-style-type: none"> And - all filters must be passed; Or - enough if one filter is passed; And/Or - uses <i>And</i> with different macro names and <i>Or</i> with the same macro name; Custom expression - offers the possibility to define a custom calculation of filters. The formula must include all filters in the list. Limited to 255 symbols.
Filters	<p>The following filter condition operators are available: <i>matches</i>, <i>does not match</i>, <i>exists</i>, <i>does not exist</i>.</p> <p><i>Matches</i> and <i>does not match</i> operators expect a Perl Compatible Regular Expression (PCRE). For instance, if you are only interested in C:, D:, and E: file systems, you could put <code>{#FSNAME}</code> into "Macro" and <code>"^C ^D ^E"</code> regular expression into "Regular expression" text fields. Filtering is also possible by file system types using <code>{#FSTYPE}</code> macro (e.g. <code>"^ext ^reiserfs"</code>) and by drive types (supported only by Windows agent) using <code>{#FSDRIVETYPE}</code> macro (e.g., "fixed"). You can enter a regular expression or reference a global regular expression in "Regular expression" field.</p> <p>In order to test a regular expression you can use "grep -E", for example: <code>for f in ext2 nfs reiserfs smbfs; do echo \$f grep -E '^ext ^reiserfs' echo "SKIP: \$f"; done</code></p> <p><i>Exists</i> and <i>does not exist</i> operators allow to filter entities based on the presence or absence of the specified LLD macro in the response.</p> <p>Note that if a macro from the filter is missing in the response, the found entity will be ignored, unless a "does not exist" condition is specified for this macro.</p> <p>A warning will be displayed, if the absence of a macro affects the expression result. For example, if <code>{#B}</code> is missing in:</p> <pre>{#A} matches 1 and {#B} matches 2 - will give a warning {#A} matches 1 or {#B} matches 2 - no warning</pre>

Warning:

A mistake or a typo in the regular expression used in the LLD rule (for example, an incorrect "File systems for discovery" regular expression) may cause deletion of thousands of configuration elements, historical values, and events for many hosts.

Attention:

Zabbix database in MySQL must be created as case-sensitive if file system names that differ only by case are to be discovered correctly.

Override

The **Override** tab allows setting rules to modify the list of item, trigger, graph and host prototypes or their attributes for discovered objects that meet given criteria.

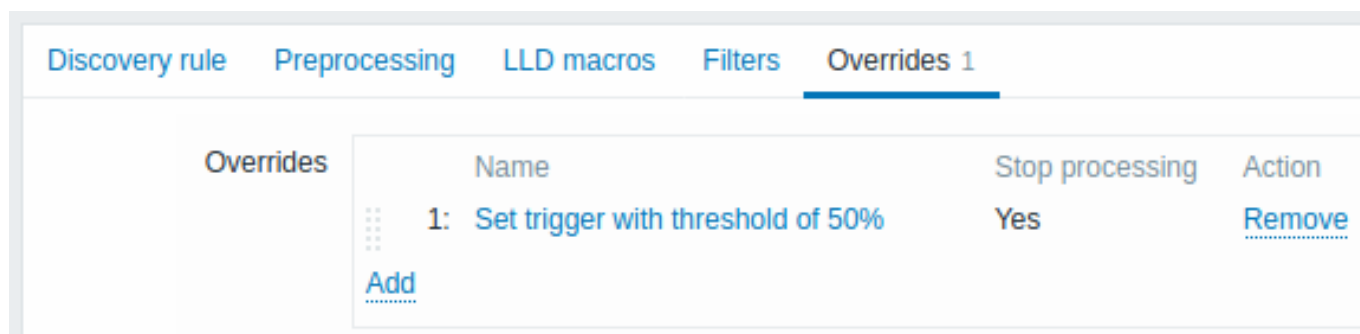

Overrides (if any) are displayed in a reorderable drag-and-drop list and executed in the order in which they are defined. To configure details of a new override, click on [Add](#) in the *Overrides* block. To edit an existing override, click on the override name. A popup window will open allowing to edit the override rule details.

Override

*** Name**

If filter matches

Filters

	Label Macro		Regular expression
A	<input type="text" value="{#FSNAME}"/>	matches <input type="button" value="v"/>	<input type="text" value="^Vtmp\$"/>

[Add](#)

Operations

Condition
Trigger prototype does not equal *Disk space is low (used > 50%)*

[Add](#)

All mandatory parameters are marked with red asterisks.

Parameter	Description
<i>Name</i>	A unique (per LLD rule) override name.
<i>If filter matches</i>	Defines whether next overrides should be processed when filter conditions are met: Continue overrides - subsequent overrides will be processed. Stop processing - operations from preceding (if any) and this override will be executed, subsequent overrides will be ignored for matched LLD rows.
<i>Filters</i>	Determines to which discovered entities the override should be applied. Override filters are processed after discovery rule filters and have the same functionality.
<i>Operations</i>	Override operations are displayed with these details: Condition - an object type (item prototype/trigger prototype/graph prototype/host prototype) and a condition to be met (equals/does not equal/contains/does not contain/matches/does not match) Actions - links for editing and removing an operation are displayed.

Configuring an operation

To configure details of a new operation, click on [Add](#) in the Operations block. To edit an existing operation, click on [Edit](#) next to the operation. A popup window where you can edit the operation details will open.

New operation

Object

Condition

Create enabled Original

Discover

Severity Original

Tags Original

[Add](#)

Parameter	Description
<i>Object</i>	Four types of objects are available: Item prototype Trigger prototype Graph prototype Host prototype
<i>Condition</i>	Allows filtering entities to which the operation should be applied.
Operator	Supported operators: equals - apply to this prototype does not equal - apply to all prototypes, except this contains - apply, if prototype name contains this string does not contain - apply, if prototype name does not contain this string matches - apply, if prototype name matches regular expression does not match - apply, if prototype name does not match regular expression
Pattern	A regular expression or a string to search for.
Object: <i>Item</i> <i>pro-</i> <i>to-</i> <i>type</i>	
<i>Create enabled</i>	When the checkbox is marked, the buttons will appear, allowing to override original item prototype settings: <i>Yes</i> - the item will be added in an enabled state. <i>No</i> - the item will be added to a discovered entity but in a disabled state.
<i>Discover</i>	When the checkbox is marked, the buttons will appear, allowing to override original item prototype settings: <i>Yes</i> - the item will be added. <i>No</i> - the item will not be added.
<i>Update interval</i>	When the checkbox is marked, two options will appear, allowing to set different interval for the item: <i>Delay</i> - Item update interval. User macros and time suffixes (e.g. 30s, 1m, 2h, 1d) are supported. Should be set to 0 if <i>Custom interval</i> is used. <i>Custom interval</i> - click Add to specify flexible/scheduling intervals. For detailed information see Custom intervals .

Parameter	Description
<i>History</i>	When the checkbox is marked, the buttons will appear, allowing different history storage period to be set for the item: <i>Do not store</i> - if selected, the history will not be stored. <i>Store up to</i> - if selected, an input field for specifying storage period will appear to the right. User macros and LLD macros are supported.
<i>Trends</i>	When the checkbox is marked, the buttons will appear, allowing different trend storage period to be set for the item: <i>Do not store</i> - if selected, the trends will not be stored. <i>Store up to</i> - if selected, an input field for specifying storage period will appear to the right. User macros and LLD macros are supported.
<i>Tags</i>	When the checkbox is marked, a new block will appear, allowing to specify tag-value pairs. These tags will be appended to the tags specified in the item prototype, even if the tag names match.
Object: <i>Trig- ger pro- to- type</i>	
<i>Create enabled</i>	When the checkbox is marked, the buttons will appear, allowing to override original trigger prototype settings: <i>Yes</i> - the trigger will be added in an enabled state. <i>No</i> - the trigger will be added to a discovered entity, but in a disabled state.
<i>Discover</i>	When the checkbox is marked, the buttons will appear, allowing to override original trigger prototype settings: <i>Yes</i> - the trigger will be added. <i>No</i> - the trigger will not be added.
<i>Severity</i>	When the checkbox is marked, trigger severity buttons will appear, allowing to modify trigger severity.
<i>Tags</i>	When the checkbox is marked, a new block will appear, allowing to specify tag-value pairs. These tags will be appended to the tags specified in the trigger prototype, even if the tag names match.
Object: <i>Graph pro- to- type</i>	
<i>Discover</i>	When the checkbox is marked, the buttons will appear, allowing to override original graph prototype settings: <i>Yes</i> - the graph will be added. <i>No</i> - the graph will not be added.
Object: <i>Host pro- to- type</i>	
<i>Create enabled</i>	When the checkbox is marked, the buttons will appear, allowing to override original host prototype settings: <i>Yes</i> - the host will be created in an enabled state. <i>No</i> - the host will be created in a disabled state.
<i>Discover</i>	When the checkbox is marked, the buttons will appear, allowing to override original host prototype settings: <i>Yes</i> - the host will be discovered. <i>No</i> - the host will not be discovered.
<i>Link templates</i>	When the checkbox is marked, an input field for specifying templates will appear. Start typing the template name or click on <i>Select</i> next to the field and select templates from the list in a popup window. All templates linked to a host prototype will be replaced by templates from this override.

Parameter	Description
<i>Tags</i>	When the checkbox is marked, a new block will appear, allowing to specify tag-value pairs. These tags will be appended to the tags specified in the host prototype, even if the tag names match.
<i>Host inventory</i>	When the checkbox is marked, the buttons will appear, allowing to select different inventory <i>mode</i> for the host prototype: <i>Disabled</i> - do not populate host inventory <i>Manual</i> - provide details manually <i>Automated</i> - auto-fill host inventory data based on collected metrics.

Form buttons

Buttons at the bottom of the form allow to perform several operations.

Add	Add a discovery rule. This button is only available for new discovery rules.
Update	Update the properties of a discovery rule. This button is only available for existing discovery rules.
Clone	Create another discovery rule based on the properties of the current discovery rule.
Check now	Perform discovery based on the discovery rule immediately. The discovery rule must already exist. See more details . <i>Note</i> that when performing discovery immediately, configuration cache is not updated, thus the result will not reflect very recent changes to discovery rule configuration.
Delete	Delete the discovery rule.
Cancel	Cancel the editing of discovery rule properties.

Discovered entities The screenshots below illustrate how discovered items, triggers, and graphs look like in the host's configuration. Discovered entities are prefixed with an orange link to a discovery rule they come from.

<input type="checkbox"/>	Wizard	Name	Triggers	Key
<input type="checkbox"/>	...	Mounted filesystem discovery: Free disk space on / (percentage)	Triggers 1	vfs.fs.size[/,pfr
<input type="checkbox"/>	...	Mounted filesystem discovery: Used disk space on /		vfs.fs.size[/,use
<input type="checkbox"/>	...	Mounted filesystem discovery: Free disk space on /		vfs.fs.size[/,free
<input type="checkbox"/>	...	Mounted filesystem discovery: Free inodes on / (percentage)	Triggers 1	vfs.fs.inode[/,p'

Note that discovered entities will not be created in case there are already existing entities with the same uniqueness criteria, for example, an item with the same key or graph with the same name. An error message is displayed in this case in the frontend that the low-level discovery rule could not create certain entities. The discovery rule itself, however, will not turn unsupported because some entity could not be created and had to be skipped. The discovery rule will go on creating/updating other entities.

If a discovered entity (host, file system, interface, etc) stops being discovered (or does not pass the filter anymore) the entities that were created based on it may be automatically disabled and eventually deleted.

Lost resources may be automatically disabled based on the value of the *Disable lost resources* parameter. This affects lost hosts, items and triggers.

Lost resources may be automatically deleted based on the value of the *Delete lost resources* parameter. This affects lost hosts, host groups, items, triggers, and graphs.

When discovered entities become 'Not discovered anymore', a lifetime indicator is displayed in the entity list. Move your mouse pointer over it and a message will be displayed indicating its status details.

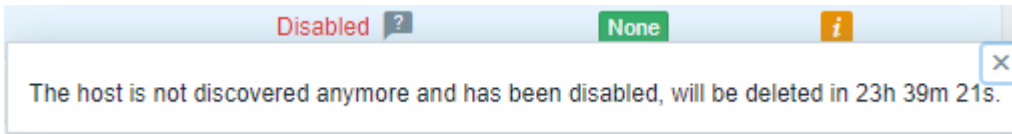

If entities were marked for deletion, but were not deleted at the expected time (disabled discovery rule or item host), they will be deleted the next time the discovery rule is processed.

Entities containing other entities, which are marked for deletion, will not update if changed on the discovery rule level. For example, LLD-based triggers will not update if they contain items that are marked for deletion.

Triggers

Group

All hosts / Remote proxy: New host Enabled ZBX SNMP JMX IPMI Applications 11 Items 41 T

<input type="checkbox"/>	Severity	Name ▲
<input type="checkbox"/>	Warning	<u>Mounted filesystem discovery: Free disk space is less than 20% on volume /</u>
<input type="checkbox"/>	Warning	<u>Mounted filesystem discovery: Free inodes is less than 20% on volume /</u>

Graphs

Group

All hosts / Remote proxy: New host Enabled ZBX SNMP JMX IPMI Applications 11 Items 41 T

<input type="checkbox"/>	Name ▲
<input type="checkbox"/>	<u>Template OS Linux: CPU jumps</u>
<input type="checkbox"/>	<u>Template OS Linux: CPU load</u>
<input type="checkbox"/>	<u>Template OS Linux: CPU utilization</u>
<input type="checkbox"/>	<u>Mounted filesystem discovery: Disk space usage /</u>

Other types of discovery More detail and how-tos on other types of out-of-the-box discovery is available in the following sections:

- discovery of **network interfaces**;
- discovery of **CPUs and CPU cores**;
- discovery of **SNMP OIDs**;
- discovery of **JMX objects**;
- discovery using **ODBC SQL queries**;
- discovery of **Windows services**;
- discovery of **host interfaces** in Zabbix.

For more detail on the JSON format for discovery items and an example of how to implement your own file system discoverer as a Perl script, see [creating custom LLD rules](#).

1 Item prototypes

Once a rule is created, go to the items for that rule and press "Create item prototype" to create an item prototype.

Note how the {#FSNAME} macro is used where a file system name is required. The use of a low-level discovery macro is mandatory in the item key to make sure that the discovery is processed correctly. When the discovery rule is processed, this macro will be substituted with the discovered file system.

Low-level discovery **macros** and user **macros** are supported in item prototype configuration and item value preprocessing **parameters**. Note that when used in update intervals, a single macro has to fill the whole field. Multiple macros in one field or macros mixed with text are not supported.

Note:
Context-specific escaping of low-level discovery macros is performed for safe use in regular expression and XPath preprocessing parameters.

Attributes that are specific for item prototypes:

Parameter	Description
<i>Create enabled</i>	If checked the item will be added in an enabled state. If unchecked, the item will be added to a discovered entity, but in a disabled state.
<i>Discover</i>	If checked (default) the item will be added to a discovered entity. If unchecked, the item will not be added to a discovered entity, unless this setting is overridden in the discovery rule.

We can create several item prototypes for each file system metric we are interested in:

☰ Item prototypes

All templates / Template Module Windows filesystem... Discovery list / Mounted filesystem discovery

Item prototypes 3 Trigger prototypes 2 Graph prototypes 1 Host prototypes

<input type="checkbox"/>	Name ▲	Key	Interval
<input type="checkbox"/>	... {#FSNAME}: Space utilization	vfs.fs.size[{#FSNAME},pused]	1m
<input type="checkbox"/>	... {#FSNAME}: Total space	vfs.fs.size[{#FSNAME},total]	1m
<input type="checkbox"/>	... {#FSNAME}: Used space	vfs.fs.size[{#FSNAME},used]	1m

0 selected

Click on the three-dot icon to open the menu for the specific item prototype with these options:

- *Create trigger prototype* - create a trigger prototype based on this item prototype
- *Trigger prototypes* - click to see a list with links to already-configured trigger prototypes of this item prototype
- *Create dependent item* - create a dependent item for this item prototype

Mass update option is available if you want to update properties of several item prototypes at once.

2 Trigger prototypes

We create trigger prototypes in a similar way as item prototypes:

New trigger prototype
?
×

Trigger prototype
Tags
Dependencies

* Name

Event name

Operational data

Severity Not classified Information Warning Average High Disaster

* Expression Add

Expression constructor

OK event generation Expression Recovery expression None

PROBLEM event generation mode Single Multiple

OK event closes All problems All problems if tag values match

Allow manual close

Menu entry name ?

Menu entry URL

Description

Create enabled

Discover

Add
Cancel

Attributes that are specific for trigger prototypes:

Parameter	Description
<i>Create enabled</i>	If checked the trigger will be added in an enabled state.
<i>Discover</i>	If unchecked, the trigger will be added to a discovered entity, but in a disabled state. If checked (default) the trigger will be added to a discovered entity. If unchecked, the trigger will not be added to a discovered entity, unless this setting is overridden in the discovery rule.

When real triggers are created from the prototypes, there may be a need to be flexible as to what constant ('20' in our example) is used for comparison in the expression. See how [user macros with context](#) can be useful to accomplish such flexibility.

You can define [dependencies](#) between trigger prototypes. To do that, go to the *Dependencies* tab. A trigger prototype may depend on another trigger prototype from the same low-level discovery (LLD) rule or on a regular trigger. A trigger prototype may not depend on a trigger prototype from a different LLD rule or on a trigger created from trigger prototype. Host trigger prototype cannot depend on a trigger from a template.

Trigger prototypes

All templates / Linux by Zabbix agent
Discovery list / Mounted filesystem discovery
Item prototypes 2
Trigger prototypes 2
Graph prototypes
Host prototypes

<input type="checkbox"/> Severity	Name ▲	Operational data	Expression
Warning	Free disk space is less than 20% on volume {#FSNAME}	Space used: {ITEM.LASTVALUE1}	last(/Linux by Zabbix agent/vfs.fs.size[{#FSNAME},pused])>80
Warning	Free inodes is less than 20% on volume {#FSNAME}	Free inodes: {ITEM.LASTVALUE1}	min(/Linux by Zabbix agent/vfs.fs.inode[{#FSNAME},pfree],5m)<20

3 Graph prototypes

We can create graph prototypes, too:

Graph prototype
Preview

* Name

* Width

* Height

Graph type

Show legend

3D view

* Items

	Name	Type
⋮	1: Template Module Linux filesystems by Zabbix agent: {#FSNAME}: Total space	Graph
⋮	2: Template Module Linux filesystems by Zabbix agent: {#FSNAME}: Used space	Simple

[Add](#) [Add prototype](#)

Discover

Attributes that are specific for graph prototypes:

Parameter	Description
<i>Discover</i>	If checked (default) the graph will be added to a discovered entity. If unchecked, the graph will not be added to a discovered entity, unless this setting is overridden in the discovery rule.

Graph prototypes

All templates / Template OS Linux Discovery list / Mounted filesystem discovery Item prototypes 5

	NAME ▲	WIDTH
<input type="checkbox"/>	Disk space usage {#FSNAME}	600

Finally, we have created a discovery rule that looks as shown below. It has five item prototypes, two trigger prototypes, and one graph prototype.

Discovery rules

All templates / Template Module Linux filesystems... Items Triggers Graphs Dashboards **Discovery**

<input type="checkbox"/>	Template	Name ▲	Items
<input type="checkbox"/>	Template Module Linux filesystems by Zabbix agent	Mounted filesystem discovery	Item prototypes 4

4 Host prototypes

Host prototypes are blueprints for creating hosts through **low-level discovery** rules. Before being discovered as hosts, these prototypes cannot have items and triggers, except those linked from templates.

Configuration

Host prototypes are configured under **low-level discovery rules**.

To create a host prototype:

1. Go to **Data collection → Hosts**.
2. Click **Discovery** for the required host to navigate to the list of low-level discovery rules configured for that host.
3. Click **Host prototypes** for the required discovery rule.
4. Click the **Create host prototype** button in the upper right corner.

The screenshot shows the configuration form for a host prototype. It includes fields for Host name (with macro {#VM.UUID}), Visible name (with macro {#VM.NAME}), Templates (searchable), Host groups (with 'Discovered hosts' selected), and Group prototypes (with macro {\$MACRO}). The Interfaces section has 'Inherit' and 'Custom' tabs, with a table for defining interfaces with columns for Type, IP address, DNS name, Connect to, Port, and Default. The 'Monitored by proxy' is set to '(no proxy)', and 'Create enabled' and 'Discover' are checked. 'Add' and 'Cancel' buttons are at the bottom.

Host prototypes have the same parameters as regular **hosts**; however, the following parameters support different or additional configuration:

Parameter	Description
<i>Host name</i>	This parameter must contain at least one low-level discovery macro to ensure unique host names for created hosts.
<i>Visible name</i>	Low-level discovery macros are supported.

Parameter	Description
<i>Group prototypes</i>	Allows specifying host group prototypes by using low-level discovery macros . Based on the specified group prototypes, host groups will be discovered, created and linked to the created hosts; discovered groups that have already been created by other low-level discovery rules will also be linked to the created hosts. However, discovered host groups that match manually created host groups will not be linked to the created hosts.
<i>Interfaces</i>	Set whether discovered hosts inherit the IP from the host that the discovery rule belongs to (default), or get custom interfaces . Low-level discovery macros and user macros are supported.
<i>Create enabled</i>	Set the status of discovered hosts; if unchecked, hosts will be created as disabled.
<i>Discover</i>	Set whether hosts will be created from the host prototype; if unchecked, hosts will not be created from the host prototype (unless this setting is overridden in the low-level discovery rule).

Note:

Low-level discovery macros are also supported for tag values and host prototype user macro values.
 Value maps are not supported for host prototypes.

For an example of how to configure a host prototype, see *Virtual machine monitoring*.

Host interfaces

To add custom interfaces, switch the *Interface* selector from "Inherit" to "Custom". Click [Add](#) and select the interface type - Zabbix agent, SNMP, JMX, IPMI.

Note:

If *Custom* is selected, but no interfaces have been set, the hosts will be created without interfaces.
 If *Inherit* is selected and the host prototype belongs to a template, all discovered hosts will inherit the host interface from the host to which the template is linked.

If multiple custom interfaces are specified, the primary interface can be set in the *Default* column.

For an example of how to configure a custom host interface, see *VMware monitoring setup example*.

Warning:

A host will only be created if a host interface contains correct data.

Discovered hosts

In the host list, discovered hosts are prefixed with the name of the discovery rule that created them.

Discovered hosts inherit most parameters from host prototypes as *read-only*. Only the following discovered host parameters can be configured:

- *Templates* - link additional templates or unlink manually added ones. Templates inherited from a host prototype cannot be unlinked.
- *Status* - manually enable/disable a host.
- *Tags* - manually add tags alongside tags inherited from the host prototype. Manual or inherited tags cannot have duplicates (tags with the same name and value). If an inherited tag has the same name and value as a manual tag, it will replace the manual tag during discovery.
- *Macros* - manually add host macros alongside macros inherited from the host prototype; change macro values and **types** on the host level.
- *Description*.

Discovered hosts can be deleted manually. Note, however, that they will be discovered again if discovery is enabled for them.

Hosts that are no longer discovered may be:

- automatically disabled (based on the *Disable lost resources* value of the discovery rule)
- automatically deleted (based on the *Delete lost resources* value of the discovery rule).

Note:

Zabbix does not support nested host prototypes, that is, host prototypes on hosts discovered by low-level discovery rules.

5 Notes on low-level discovery

Using LLD macros in user macro contexts

LLD macros may be used inside user macro context, for example, [in trigger prototypes](#).

Multiple LLD rules for the same item

It is possible to define several low-level discovery rules with the same discovery item.

To do that you need to define the Alias agent [parameter](#), allowing to use altered discovery item keys in different discovery rules, for example `vfs.fs.discovery[foo]`, `vfs.fs.discovery[bar]`, etc.

Data limits for return values

There is no limit for low-level discovery rule JSON data if it is received directly by Zabbix server. This is because the return values are processed without being stored in a database.

There is also no limit for custom low-level discovery rules. However, if custom low-level discovery rule data is retrieved using a user parameter, the user parameter [return value limit](#) applies.

If data has to go through Zabbix proxy, it has to store this data in the database. In such a case, [database limits](#) apply.

6 Discovery rules

Please use the sidebar to see discovery rule configuration examples for various cases.

1 Discovery of mounted filesystems

Overview

It is possible to discover mounted filesystems and their properties:

- mountpoint name
- filesystem type
- filesystem size
- inode statistics
- mount options

To do that, you may use a combination of:

- the `vfs.fs.get` agent item as the master item
- dependent low-level discovery rule and item prototypes

Configuration

Master item

Create a Zabbix agent item using the following key:

```
vfs.fs.get
```

Item	Tags	Preprocessing
* Name	vfs.fs.get item	
Type	Zabbix agent	
* Key	vfs.fs.get	
* Host interface	127.0.0.1 : 10050	
Type of information	Text	

Set the type of information to "Text" for possibly big JSON data.

The data returned by this item will contain something like the following for a mounted filesystem:

```
[
  {
    "fsname": "/",
    "fstype": "ext4",
    "bytes": {
      "total": 249405239296,
      "free": 24069537792,
      "used": 212595294208,
      "pfree": 10.170306,
      "pused": 89.829694
    },
    "inodes": {
      "total": 15532032,
      "free": 12656665,
      "used": 2875367,
      "pfree": 81.487503,
      "pused": 18.512497
    },
    "options": "rw,noatime,errors=remount-ro"
  }
]
```

Dependent LLD rule

Create a low-level discovery rule as "Dependent item" type:

Discovery rule Preprocessing LLD macros Filters Overrides

* Name

Type

* Key

* Master item

* Keep lost resources period

As master item select the `vfs.fs.get` item we created.

In the "LLD macros" tab define custom macros with the corresponding JSONPath:

Discovery rule Preprocessing LLD macros 3 Filters Overrides

LLD macros

LLD macro	JSONPath
<input data-bbox="549 994 1115 1043" type="text" value="{#FSNAME}"/>	<input data-bbox="1131 994 1476 1043" type="text" value="\$fsname"/>
<input data-bbox="549 1070 1115 1120" type="text" value="{#FSTYPE}"/>	<input data-bbox="1131 1070 1476 1120" type="text" value="\$fstype"/>
<input data-bbox="549 1146 1115 1196" type="text" value="{#FSOPTIONS}"/>	<input data-bbox="1131 1146 1476 1196" type="text" value="\$options"/>

[Add](#)

In the "Filters" tab you may add a regular expression that filters only **read-write** filesystems:

Discovery rule Preprocessing LLD macros 3 Filters 1 Overrides

Filters

Label	Macro	Operator	Regular expression
E	<input data-bbox="450 1541 914 1590" type="text" value="{#FSOPTIONS}"/>	<input data-bbox="930 1541 1209 1590" type="text" value="matches"/>	<input data-bbox="1225 1541 1476 1590" type="text" value="(.*)?rw(.*)?"/>

[Add](#)

Dependent item prototype

Create an item prototype with "Dependent item" type in this LLD rule. As master item for this prototype select the `vfs.fs.get` item we created.

Item prototype Tags Preprocessing

* Name

Type

* Key

* Master item

Type of information

Note the use of custom macros in the item prototype name and key:

- Name: Free disk space on {#FSNAME}, type: {#FSTYPE}
- Key: Free[{#FSNAME}]

As type of information, use:

- *Numeric (unsigned)* for metrics like 'free', 'total', 'used'
- *Numeric (float)* for metrics like 'pfree', 'pused' (percentage)

In the item prototype "Preprocessing" tab select JSONPath and use the following JSONPath expression as parameter:

```
$.[?(@.fsname=='{#FSNAME}')].bytes.free.first()
```

Item prototype Tags Preprocessing 1

Preprocessing steps	Name	Parameters
1:	JSONPath	<input type="text" value="\$.[?(@.fsname=='{#FSNAME}')].bytes.free.first()"/>

[Add](#)

When discovery starts, one item per each mountpoint will be created. This item will return the number of free bytes for the given mountpoint.

2 Discovery of network interfaces

In a similar way as **file systems** are discovered, it is possible to also discover network interfaces.

Item key

The item key to use in the **discovery rule** is

```
net.if.discovery
```

Supported macros

You may use the {#IFNAME} macro in the discovery rule **filter** and prototypes of items, triggers and graphs.

Examples of item prototypes that you might wish to create based on "net.if.discovery":

- "net.if.in[{#IFNAME},bytes]"
- "net.if.out[{#IFNAME},bytes]"

Note that on Windows {#IFGUID} is also returned.

3 Discovery of CPUs and CPU cores

In a similar way as [file systems](#) are discovered, it is possible to also discover CPUs and CPU cores.

Item key

The item key to use in the [discovery rule](#) is

```
system.cpu.discovery
```

Supported macros

This discovery key returns two macros - `{#CPU.NUMBER}` and `{#CPU.STATUS}` identifying the CPU order number and status respectively. It enumerates processors from 0 to N - 1, where N is total processor count.

```
[
  {
    "{#CPU.NUMBER}": 0,
    "{#CPU.STATUS}": "online"
  },
  {
    "{#CPU.NUMBER}": 1,
    "{#CPU.STATUS}": "offline"
  },
  {
    "{#CPU.NUMBER}": 2,
    "{#CPU.STATUS}": "unknown" /* "unknown" is at Windows only */
  },
  {
    "{#CPU.NUMBER}": 3,
    "{#CPU.STATUS}": "online"
  }
]
```

Note that a clear distinction cannot be made between actual, physical processors, cores and hyperthreads. `{#CPU.STATUS}` on Linux, UNIX and BSD systems returns the status of the processor, which can be either "online" or "offline". On Windows systems, this same macro may represent a third value - "unknown" - which indicates that a processor has been detected, but no information has been collected for it yet.

CPU discovery relies on the agent's collector process to remain consistent with the data provided by the collector and save resources on obtaining the data. This has the effect of this item key not working with the test (-t) command line flag of the agent binary, which will return a NOT_SUPPORTED status and an accompanying message indicating that the collector process has not been started.

Item prototypes that can be created based on CPU discovery include, for example:

- `system.cpu.util[{#CPU.NUMBER},<type>,<mode>]`
- `system.hw.cpu[{#CPU.NUMBER},<info>]`

For detailed item key description, see [Zabbix agent item keys](#).

Notes on discovered performance counter items on NUMA systems

Some [Windows performance counters](#) might be not available for some of the logical processors at NUMA systems.

For example, items discovered with an item prototype with the key below might work only for the first NUMA node. Items for the other NUMA nodes might be in unsupported state.

```
perf_counter[\Processor({#CPU.NUMBER})\% Processor Time,60]
```

Also, a discovery rule with key "system.cpu.discovery" does not provide any low-level discovery macro values to substitute into such performance counters as:

```
perf_counter["\Processor Information(<NUMA node index>,<CPU index in NUMA node>)\% Processor Time",60]
```

While `system.cpu.util` items rely on different performance counters to monitor CPU utilization percentage depending on the processor group count and processor count. Also, there is a rare bug related to [processor groups on Windows](#).

4 Discovery of SNMP OIDs

Overview

In this section we will perform an SNMP *discovery* on a switch.

This discovery method of SNMP OIDs has been supported since Zabbix server/proxy 6.4.

Item key

Create an SNMP item, using the following item key in the *SNMP OID* field:

walk[1.3.6.1.2.1.2.2.1.2,1.3.6.1.2.1.2.2.1.3]

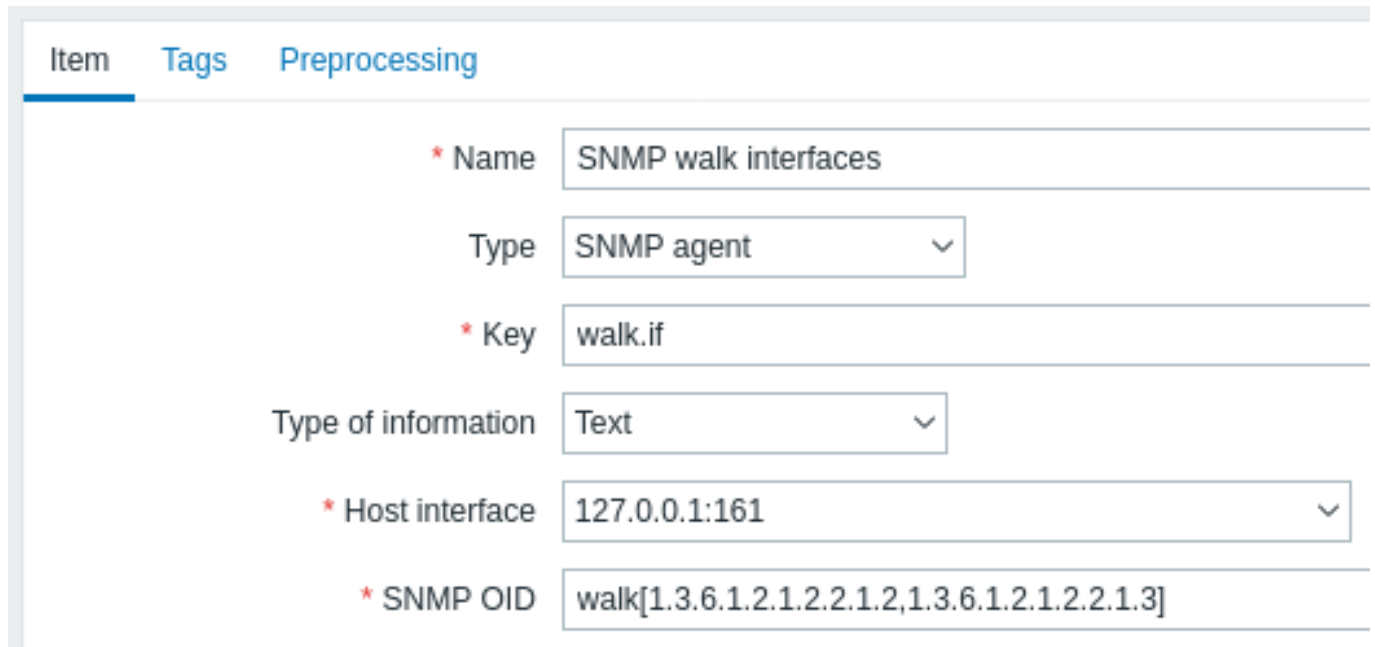

The screenshot shows the 'Item' configuration form in Zabbix. The 'Name' field is 'SNMP walk interfaces'. The 'Type' dropdown is set to 'SNMP agent'. The 'Key' field is 'walk.if'. The 'Type of information' dropdown is set to 'Text'. The 'Host interface' dropdown is set to '127.0.0.1:161'. The 'SNMP OID' field contains the value 'walk[1.3.6.1.2.1.2.2.1.2,1.3.6.1.2.1.2.2.1.3]'. The 'Item' tab is selected at the top.

This item will perform an snmpwalk for the OIDs specified in the parameters (1.3.6.1.2.1.2.2.1.2, 1.3.6.1.2.1.2.2.1.3), returning a concatenated list of values, e.g.:

```
.1.3.6.1.2.1.2.2.1.2.1 = STRING: "lo"  
.1.3.6.1.2.1.2.2.1.2.2 = STRING: "ens33"  
.1.3.6.1.2.1.2.2.1.2.3 = STRING: "ens37"  
.1.3.6.1.2.1.2.2.1.3.1 = INTEGER: 24  
.1.3.6.1.2.1.2.2.1.3.2 = INTEGER: 6  
.1.3.6.1.2.1.2.2.1.3.3 = INTEGER: 6
```

Dependent discovery rule

Go to the discovery rules of your template/host. Click on *Create discovery rule* in the upper right corner of the screen.

Fill in the required details in the **Discovery rule** tab:

- Select *Dependent item* as item type
- Select the previously created SNMP walk item as the master item
- Fill the name and key with meaningful values

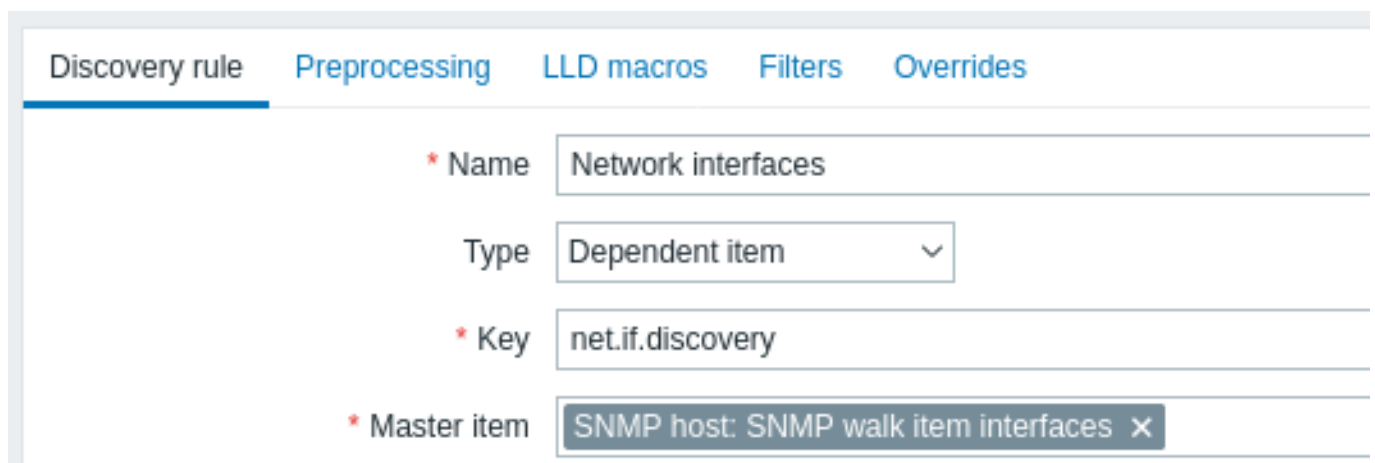

The screenshot shows the 'Discovery rule' configuration form in Zabbix. The 'Name' field is 'Network interfaces'. The 'Type' dropdown is set to 'Dependent item'. The 'Key' field is 'net.if.discovery'. The 'Master item' field is set to 'SNMP host: SNMP walk item interfaces' with a close button (X) on the right. The 'Discovery rule' tab is selected at the top.

In the **Preprocessing** tab, select the *SNMP walk to JSON* preprocessing step.

Discovery rule Preprocessing 1 LLD macros Filters Overrides

Preprocessing steps	Name	Parameters			
1:	SNMP walk to JSON	Field name	OID prefix	Format	Action
		{#F.DESCR}	1.3.6.1.2.1.2.2.1.2	Unchanged	Remove
		{#F.TYPE}	1.3.6.1.2.1.2.2.1.3	Unchanged	Remove
		Add			

In the field name specify a valid LLD macro name. Select the corresponding OID path to discover values from.

This rule will discover entities and set:

- {#IFDESCR} macros to lo, ens33, and ens37;
- {#IFTYPE} macros set to 24, 6, and 6.

A built-in macro {#SNMPINDEX} containing the index of the discovered OIDs is applied to discovered entities. The discovered entities are grouped by {#SNMPINDEX} macro value: **1**, **2** and **3**:

```
[
  {
    "{#SNMPINDEX}": "1",
    "{#IFDESCR}": "lo",
    "{#IFTYPE}": "24"
  },
  {
    "{#SNMPINDEX}": "2",
    "{#IFDESCR}": "ens33",
    "{#IFTYPE}": "6"
  },
  {
    "{#SNMPINDEX}": "3",
    "{#IFDESCR}": "ens37",
    "{#IFTYPE}": "6"
  }
]
```

If an entity does not have the specified OID, then the corresponding macro will be omitted for this entity.

Item, trigger, graph prototypes

Item prototypes must be created as **dependent** item prototypes, using macros from the discovery rule.

Dependent items will obtain their values from the walk[] master item. Thus it will not be necessary for each discovered item to query the SNMP device independently.

Trigger and graph prototypes may also be created also by using macros from the discovery rule.

Discovered entities

When server runs, it will create real dependent items, triggers and graphs based on the values the SNMP discovery rule returns.

5 Discovery of SNMP OIDs (legacy)

Overview

In this section we will perform an SNMP **discovery** on a switch.

Item key

Unlike with file system and network interface discovery, the item does not necessarily has to have an "snmp.discovery" key - item type of SNMP agent is sufficient.

To configure the discovery rule, do the following:

- Go to: *Data collection* → *Templates*
- Click on *Discovery* in the row of an appropriate template

≡ Templates

- Name ▾ Hosts Items Triggers Graphs Dashboards Discovery
- Interfaces SNMP Hosts Items Triggers Graphs Dashboards 1 Discovery 1

- Click on *Create discovery rule* in the upper right corner of the screen
- Fill in the discovery rule form with the required details as in the screenshot below

Discovery rule Preprocessing LLD macros Filters 12 Overrides

* Name

Type

* Key

* SNMP OID

* Update interval

All mandatory input fields are marked with a red asterisk.

The OIDs to discover are defined in SNMP OID field in the following format: `discovery[#{#MACRO1}, oid1, #{#MACRO2}, oid2, ...]`

where `#{#MACRO1}`, `#{#MACRO2}` ... are valid lld macro names and `oid1`, `oid2...` are OIDs capable of generating meaningful values for these macros. A built-in macro `#{#SNMPINDEX}` containing index of the discovered OID is applied to discovered entities. The discovered entities are grouped by `#{#SNMPINDEX}` macro value.

To understand what we mean, let us perform few snmpwalks on our switch:

```
$ snmpwalk -v 2c -c public 192.168.1.1 IF-MIB::ifDescr
IF-MIB::ifDescr.1 = STRING: WAN
IF-MIB::ifDescr.2 = STRING: LAN1
IF-MIB::ifDescr.3 = STRING: LAN2
```

```
$ snmpwalk -v 2c -c public 192.168.1.1 IF-MIB::ifPhysAddress
IF-MIB::ifPhysAddress.1 = STRING: 8:0:27:90:7a:75
IF-MIB::ifPhysAddress.2 = STRING: 8:0:27:90:7a:76
IF-MIB::ifPhysAddress.3 = STRING: 8:0:27:2b:af:9e
```

And set SNMP OID to: `discovery[#{#IFDESCR}, ifDescr, #{#IFPHYSADDRESS}, ifPhysAddress]`

Now this rule will discover entities with `#{#IFDESCR}` macros set to **WAN**, **LAN1** and **LAN2**, `#{#IFPHYSADDRESS}` macros set to **8:0:27:90:7a:75**, **8:0:27:90:7a:76**, and **8:0:27:2b:af:9e**, `#{#SNMPINDEX}` macros set to the discovered OIDs indexes **1**, **2** and **3**:

```
[
  {
    "#{#SNMPINDEX}": "1",
    "#{#IFDESCR}": "WAN",
    "#{#IFPHYSADDRESS}": "8:0:27:90:7a:75"
  },
  {
    "#{#SNMPINDEX}": "2",
    "#{#IFDESCR}": "LAN1",
    "#{#IFPHYSADDRESS}": "8:0:27:90:7a:76"
  },
  {
    "#{#SNMPINDEX}": "3",
```

```

    "{#IFDESCR}": "LAN2",
    "{#IFPHYSADDRESS}": "8:0:27:2b:af:9e"
  }
]

```

If an entity does not have the specified OID, then the corresponding macro will be omitted for this entity. For example if we have the following data:

```

ifDescr.1 "Interface #1"
ifDescr.2 "Interface #2"
ifDescr.4 "Interface #4"

ifAlias.1 "eth0"
ifAlias.2 "eth1"
ifAlias.3 "eth2"
ifAlias.5 "eth4"

```

Then in this case SNMP discovery `discovery[#{IFDESCR}, ifDescr, {#IFALIAS}, ifAlias]` will return the following structure:

```

[
  {
    "{#SNMPINDEX}": 1,
    "{#IFDESCR}": "Interface #1",
    "{#IFALIAS}": "eth0"
  },
  {
    "{#SNMPINDEX}": 2,
    "{#IFDESCR}": "Interface #2",
    "{#IFALIAS}": "eth1"
  },
  {
    "{#SNMPINDEX}": 3,
    "{#IFALIAS}": "eth2"
  },
  {
    "{#SNMPINDEX}": 4,
    "{#IFDESCR}": "Interface #4"
  },
  {
    "{#SNMPINDEX}": 5,
    "{#IFALIAS}": "eth4"
  }
]

```

Item prototypes

The following screenshot illustrates how we can use these macros in item prototypes:

Item prototype Tags Preprocessing 2

* Name

Type

* Key

Type of information

* SNMP OID

Units

* Update interval

You can create as many item prototypes as needed:

☰ Item prototypes

All templates / Linux SNMP								Discovery list / Network interfaces discovery			Item prototypes 9		Trigger prototypes 4		Graph prototypes 1		Host prototypes		
<input type="checkbox"/>	Name ▲	Key	Interval	History	Trends	Type	Create enabled												
<input type="checkbox"/>	... Interface {#IFNAME}({#IFALIAS}): Bits received	net.if.in[ifHCInOctets.{#SNMPINDEX}]]	3m	7d	365d	SNMP agent	Yes												
<input type="checkbox"/>	... Interface {#IFNAME}({#IFALIAS}): Bits sent	net.if.out[ifHCOutOctets.{#SNMPINDEX}]]	3m	7d	365d	SNMP agent	Yes												
<input type="checkbox"/>	... Interface {#IFNAME}({#IFALIAS}): Inbound packets discarded	net.if.in.discards[ifInDiscards.{#SNMPINDEX}]]	3m	7d	365d	SNMP agent	Yes												
<input type="checkbox"/>	... Interface {#IFNAME}({#IFALIAS}): Inbound packets with errors	net.if.in.errors[ifInErrors.{#SNMPINDEX}]]	3m	7d	365d	SNMP agent	Yes												
<input type="checkbox"/>	... Interface {#IFNAME}({#IFALIAS}): Interface type	net.if.type[ifType.{#SNMPINDEX}]]	1h	7d	0d	SNMP agent	Yes												
<input type="checkbox"/>	... Interface {#IFNAME}({#IFALIAS}): Operational status	net.if.status[ifOperStatus.{#SNMPINDEX}]]	1m	7d	0	SNMP agent	Yes												
<input type="checkbox"/>	... Interface {#IFNAME}({#IFALIAS}): Outbound packets discarded	net.if.out.discards[ifOutDiscards.{#SNMPINDEX}]]	3m	7d	365d	SNMP agent	Yes												
<input type="checkbox"/>	... Interface {#IFNAME}({#IFALIAS}): Outbound packets with errors	net.if.out.errors[ifOutErrors.{#SNMPINDEX}]]	3m	7d	365d	SNMP agent	Yes												
<input type="checkbox"/>	... Interface {#IFNAME}({#IFALIAS}): Speed	net.if.speed[ifHighSpeed.{#SNMPINDEX}]]	5m	7d	0d	SNMP agent	Yes												

Trigger prototypes

The following screenshot illustrates how we can use these macros in trigger prototypes:

Trigger prototype [Tags](#) [Dependencies](#)

*** Name** Interface {#IFNAME}{#IFALIAS}: Link down

Event name Interface {#IFNAME}{#IFALIAS}: Link down

Operational data Current state: {ITEM.LASTVALUE1}

Severity Not classified Information Warning Average High Disaster

*** Problem expression** `{${IFCONTROL:"{#IFNAME}"}=1 and last(/SNMP host/net.if.status[ifOperStatus.{#SNMPINDEX}])=2 and (last(/SNMP host/net.if.status[ifOperStatus.{#SNMPINDEX}], #1)<>last(/SNMP host/net.if.status[ifOperStatus.{#SNMPINDEX}], #2))`

[Expression constructor](#)

OK event generation Expression Recovery expression None

*** Recovery expression** `last(/SNMP host/net.if.status[ifOperStatus.{#SNMPINDEX}])<>2 or {${IFCONTROL:"{#IFNAME}"}=0`

Trigger prototypes

All templates / [Linux SNMP](#) [Discovery list](#) / [Network interfaces discovery](#) [Item prototypes 9](#) [Trigger prototypes 4](#) [Graph prototypes 1](#) [Host prototypes](#)

<input type="checkbox"/>	Severity	Name ▲	Operational data	Expression	Create enabled
<input type="checkbox"/>	Information	Interface {#IFNAME} ({#IFALIAS}): Ethernet has changed to lower speed than it was before Depends on: Linux SNMP: Interface {#IFNAME}({#IFALIAS}): Link down	Current reported speed: {ITEM.LASTVALUE1}	Problem: change (/Linux SNMP/net.if.speed[ifHighSpeed.{#SNMPINDEX}])<0 and last (/Linux SNMP/net.if.speed[ifHighSpeed.{#SNMPINDEX}])>0 and (last (/Linux SNMP/net.if.type[ifType.{#SNMPINDEX}])=6 or last (/Linux SNMP/net.if.type[ifType.{#SNMPINDEX}])=7 or last (/Linux SNMP/net.if.type[ifType.{#SNMPINDEX}])=11 or last (/Linux SNMP/net.if.type[ifType.{#SNMPINDEX}])=62 or last (/Linux SNMP/net.if.type[ifType.{#SNMPINDEX}])=69 or last (/Linux SNMP/net.if.type[ifType.{#SNMPINDEX}])=117) and (last (/Linux SNMP/net.if.status[ifOperStatus.{#SNMPINDEX}])<>2) Recovery: (change (/Linux SNMP/net.if.speed[ifHighSpeed.{#SNMPINDEX}])>0 and last (/Linux SNMP/net.if.speed[ifHighSpeed.{#SNMPINDEX}].#2)>0) or (last (/Linux SNMP/net.if.status[ifOperStatus.{#SNMPINDEX}])=2)	Yes
<input type="checkbox"/>	Warning	Interface {#IFNAME} ({#IFALIAS}): High bandwidth usage Depends on: Linux SNMP: Interface {#IFNAME}({#IFALIAS}): Link down	In: {ITEM.LASTVALUE1}, out: {ITEM.LASTVALUE3}, speed: {ITEM.LASTVALUE2}	Problem: (avg (/Linux SNMP/net.if.in[ifHCInOctets.{#SNMPINDEX}].15m)>{\${IFUTIL.MAX:"{#IFNAME}"}*100}* last (/Linux SNMP/net.if.speed[ifHighSpeed.{#SNMPINDEX}]) or avg (/Linux SNMP/net.if.out[ifHCOutOctets.{#SNMPINDEX}].15m)>{\${IFUTIL.MAX:"{#IFNAME}"}*100}* last (/Linux SNMP/net.if.speed[ifHighSpeed.{#SNMPINDEX}])) and last (/Linux SNMP/net.if.speed[ifHighSpeed.{#SNMPINDEX}])>0 Recovery: avg (/Linux SNMP/net.if.in[ifHCInOctets.{#SNMPINDEX}].15m)<{\${IFUTIL.MAX:"{#IFNAME}"}*3/100}* last (/Linux SNMP/net.if.speed[ifHighSpeed.{#SNMPINDEX}]) and avg (/Linux SNMP/net.if.out[ifHCOutOctets.{#SNMPINDEX}].15m)<{\${IFUTIL.MAX:"{#IFNAME}"}*3/100}* last (/Linux SNMP/net.if.speed[ifHighSpeed.{#SNMPINDEX}]))	Yes
<input type="checkbox"/>	Warning	Interface {#IFNAME} ({#IFALIAS}): High error rate Depends on: Linux SNMP: Interface {#IFNAME}({#IFALIAS}): Link down	errors in: {ITEM.LASTVALUE1}, errors out: {ITEM.LASTVALUE2}	Problem: min (/Linux SNMP/net.if.in.errors[ifInErrors.{#SNMPINDEX}].5m)>{\${IFERRORS.WARN:"{#IFNAME}"} or min (/Linux SNMP/net.if.out.errors[ifOutErrors.{#SNMPINDEX}].5m)>{\${IFERRORS.WARN:"{#IFNAME}"} Recovery: max (/Linux SNMP/net.if.in.errors[ifInErrors.{#SNMPINDEX}].5m)<{\${IFERRORS.WARN:"{#IFNAME}"}*0.8 and max (/Linux SNMP/net.if.out.errors[ifOutErrors.{#SNMPINDEX}].5m)<{\${IFERRORS.WARN:"{#IFNAME}"}*0.8	Yes
<input type="checkbox"/>	Average	Interface {#IFNAME} ({#IFALIAS}): Link down	Current state: {ITEM.LASTVALUE1}	Problem: {\${IFCONTROL:"{#IFNAME}"}=1 and last (/Linux SNMP/net.if.status[ifOperStatus.{#SNMPINDEX}])=2 and (last (/Linux SNMP/net.if.status[ifOperStatus.{#SNMPINDEX}].#1)<> last (/Linux SNMP/net.if.status[ifOperStatus.{#SNMPINDEX}].#2))	Yes

Graph prototypes

The following screenshot illustrates how we can use these macros in graph prototypes:

Graph prototype [Preview](#)

* Name

* Width

* Height

Graph type

Show legend

Show working time

Show triggers

Percentile line (left)

Percentile line (right)

Y axis MIN value

Y axis MAX value

* Items

	Name	Function	Draw style	Y axis side	Color
1:	SNMP host: Interface {#IFNAME}{#IFALIAS}: Bits received	avg	Gradient line	Left	
2:	SNMP host: Interface {#IFNAME}{#IFALIAS}: Bits sent	avg	Bold line	Left	
3:	SNMP host: Interface {#IFNAME}{#IFALIAS}: Outbound packets with errors	avg	Line	Right	
4:	SNMP host: Interface {#IFNAME}{#IFALIAS}: Inbound packets with errors	avg	Line	Right	
5:	SNMP host: Interface {#IFNAME}{#IFALIAS}: Outbound packets discarded	avg	Line	Right	
6:	SNMP host: Interface {#IFNAME}{#IFALIAS}: Inbound packets discarded	avg	Line	Right	

[Add](#) [Add prototype](#)

≡ Graph prototypes

All templates / Linux SNMP Discovery list / Network interfaces discovery Item prototypes 9 Trigger prototypes 4 **Graph prototypes 1** Host prototypes

<input type="checkbox"/>	Name ▲	Width	Height
<input type="checkbox"/>	Interface {#IFNAME}{#IFALIAS}: Network traffic	900	200

A summary of our discovery rule:

All templates / Linux SNMP Items 26 Triggers 10 Graphs 5 Dashboards 2 **Discovery rules 5** Web scenarios

<input type="checkbox"/>	Template	Name ▲	Items	Triggers	Graphs
<input type="checkbox"/>	Linux SNMP	Network interfaces discovery	Item prototypes 9	Trigger prototypes 4	Graph prototypes 1

Discovered entities

When server runs, it will create real items, triggers and graphs based on the values the SNMP discovery rule returns. In the host configuration they are prefixed with an orange link to a discovery rule they come from.

Items

All hosts / SNMP host Enabled SNMP Items 81 Triggers 23 Graphs 14 Discovery rules 6 Web scenarios									
<input type="checkbox"/>	Name ▲	Triggers	Key	Interval	History	Trends	Type	Status	
<input type="checkbox"/>	... Network interfaces discovery: Interface enp4s0(): Bits received	Triggers 1	net.if.in[ifHCInOctets.2]	3m	7d	365d	SNMP agent	Enabled	
<input type="checkbox"/>	... Network interfaces discovery: Interface enp4s0(): Bits sent	Triggers 1	net.if.out[ifHCOutOctets.2]	3m	7d	365d	SNMP agent	Enabled	
<input type="checkbox"/>	... Network interfaces discovery: Interface enp4s0(): Inbound packets discarded		net.if.in.discards[ifInDiscards.2]	3m	7d	365d	SNMP agent	Enabled	
<input type="checkbox"/>	... Network interfaces discovery: Interface enp4s0(): Inbound packets with errors	Triggers 1	net.if.in.errors[ifInErrors.2]	3m	7d	365d	SNMP agent	Enabled	
<input type="checkbox"/>	... Network interfaces discovery: Interface enp4s0(): Interface type	Triggers 1	net.if.type[ifType.2]	1h	7d	0d	SNMP agent	Enabled	
<input type="checkbox"/>	... Network interfaces discovery: Interface enp4s0(): Operational status	Triggers 2	net.if.status[ifOperStatus.2]	1m	7d	0	SNMP agent	Enabled	
<input type="checkbox"/>	... Network interfaces discovery: Interface enp4s0(): Outbound packets discarded		net.if.out.discards[ifOutDiscards.2]	3m	7d	365d	SNMP agent	Enabled	
<input type="checkbox"/>	... Network interfaces discovery: Interface enp4s0(): Outbound packets with errors	Triggers 1	net.if.out.errors[ifOutErrors.2]	3m	7d	365d	SNMP agent	Enabled	
<input type="checkbox"/>	... Network interfaces discovery: Interface enp4s0(): Speed	Triggers 2	net.if.speed[ifHighSpeed.2]	5m	7d	0d	SNMP agent	Enabled	

Triggers

All hosts / SNMP host Enabled SNMP Items 81 Triggers 23 Graphs 14 Discovery rules 6 Web scenarios					
<input type="checkbox"/>	Severity	Value	Name ▲	Operational data	Expression
<input type="checkbox"/>	Information	OK	Network interfaces discovery: Interface enp4s0(): Ethernet has changed to lower speed than it was before Depends on: SNMP host: Interface enp4s0(): Link down	Current reported speed: {ITEM.LASTVALUE1}	Problem: <code>change(/SNMP host/net.if.speed[ifHighSpeed.2])<0 and last(/SNMP host/net.if.speed[ifHighSpeed.2])>0 and (last(/SNMP host/net.if.type[ifType.2])=6 or last(/SNMP host/net.if.type[ifType.2])=7 or last(/SNMP host/net.if.type[ifType.2])=11 or last(/SNMP host/net.if.type[ifType.2])=62 or last(/SNMP host/net.if.type[ifType.2])=69 or last(/SNMP host/net.if.type[ifType.2])=117) and (last(/SNMP host/net.if.status[ifOperStatus.2])<2)</code> Recovery: <code>(change(/SNMP host/net.if.speed[ifHighSpeed.2])>0 and last(/SNMP host/net.if.speed[ifHighSpeed.2],#2)>0) or (last(/SNMP host/net.if.status[ifOperStatus.2])=2)</code>
<input type="checkbox"/>	Warning	OK	Network interfaces discovery: Interface enp4s0(): High bandwidth usage Depends on: SNMP host: Interface enp4s0(): Link down	In: {ITEM.LASTVALUE1}, out: {ITEM.LASTVALUE3}, speed: {ITEM.LASTVALUE2}	Problem: <code>(avg(/SNMP host/net.if.in[ifHCInOctets.2],15m)>{(\$IF.UTIL.MAX:"enp4s0")/100}*last(/SNMP host/net.if.speed[ifHighSpeed.2]) or avg(/SNMP host/net.if.out[ifHCOutOctets.2],15m)>{(\$IF.UTIL.MAX:"enp4s0")/100}*last(/SNMP host/net.if.speed[ifHighSpeed.2])) and last(/SNMP host/net.if.speed[ifHighSpeed.2])>0</code> Recovery: <code>avg(/SNMP host/net.if.in[ifHCInOctets.2],15m)<{(\$IF.UTIL.MAX:"enp4s0")*3/100}*last(/SNMP host/net.if.speed[ifHighSpeed.2]) and avg(/SNMP host/net.if.out[ifHCOutOctets.2],15m)<{(\$IF.UTIL.MAX:"enp4s0")*3/100}*last(/SNMP host/net.if.speed[ifHighSpeed.2])</code>
<input type="checkbox"/>	Warning	OK	Network interfaces discovery: Interface enp4s0(): High error rate Depends on: SNMP host: Interface enp4s0(): Link down	errors in: {ITEM.LASTVALUE1}, errors out: {ITEM.LASTVALUE2}	Problem: <code>min(/SNMP host/net.if.in.errors[ifInErrors.2],5m)>{(\$IF.ERRORS.WARN:"enp4s0") or min(/SNMP host/net.if.out.errors[ifOutErrors.2],5m)>{(\$IF.ERRORS.WARN:"enp4s0")}</code> Recovery: <code>max(/SNMP host/net.if.in.errors[ifInErrors.2],5m)<{(\$IF.ERRORS.WARN:"enp4s0")*0.8 and max(/SNMP host/net.if.out.errors[ifOutErrors.2],5m)<{(\$IF.ERRORS.WARN:"enp4s0")*0.8}</code>
<input type="checkbox"/>	Average	OK	Network interfaces discovery: Interface enp4s0(): Link down	Current state: {ITEM.LASTVALUE1}	Problem: <code>{\$IFCONTROL:"enp4s0"}=1 and last(/SNMP host/net.if.status[ifOperStatus.2])=2 and (last(/SNMP host/net.if.status[ifOperStatus.2],#1)<>last(/SNMP host/net.if.status[ifOperStatus.2],#2))</code> Recovery: <code>last(/SNMP host/net.if.status[ifOperStatus.2])<2 or {\$IFCONTROL:"enp4s0"}=0</code>

Graphs

All hosts / SNMP host Enabled SNMP Items 81 Triggers 23 Graphs 14 Discovery rules 6 Web scenarios									
<input type="checkbox"/>	Name ▲								
<input type="checkbox"/>	Mounted filesystem discovery: /: Disk space usage								
<input type="checkbox"/>	Linux SNMP: CPU jumps								
<input type="checkbox"/>	CPU discovery: CPU usage								
<input type="checkbox"/>	CPU discovery: CPU utilization								
<input type="checkbox"/>	Network interfaces discovery: Interface enp4s0(): Network traffic								

6 Discovery of JMX objects

Overview

It is possible to **discover** all JMX MBeans or MBean attributes or to specify a pattern for the discovery of these objects.

It is mandatory to understand the difference between an MBean and MBean attributes for discovery rule configuration. An MBean is an object which can represent a device, an application, or any resource that needs to be managed.

For example, there is an MBean which represents a web server. Its attributes are connection count, thread count, request timeout, http file cache, memory usage, etc. Expressing this thought in human comprehensive language we can define a coffee machine as an MBean which has the following attributes to be monitored: water amount per cup, average consumption of water for a certain period of time, number of coffee beans required per cup, coffee beans and water refill time, etc.

Item key

In **discovery rule** configuration, select **JMX agent** in the *Type* field.

Two item keys are supported for JMX object discovery - `jmx.discovery[]` and `jmx.get[]`:

Item key	Return value	Parameters	Comment
jmx.discovery [<discovery mode>,<object name>,<unique short de-scrip-tion>]	This item returns a JSON array with LLD macros describing MBean objects or their attributes.	discovery mode - one of the following: <i>attributes</i> (retrieve JMX MBean attributes, default) or <i>beans</i> (retrieve JMX MBeans) object name - object name pattern (see documentation) identifying the MBean names to be retrieved (empty by default, retrieving all registered beans) unique short description - a unique description that allows multiple JMX items with the same discovery mode and object name on the host (optional)	Examples: → <code>jmx.discovery</code> - retrieve all JMX MBean attributes → <code>jmx.discovery[beans]</code> - retrieve all JMX MBeans → <code>jmx.discovery[attributes,"*:type=GarbageCollector,name=*</code> - retrieve all garbage collector attributes → <code>jmx.discovery[beans,"*:type=GarbageCollector,name=*</code> - retrieve all garbage collectors There are some limitations to what MBean properties this item can return based on limited characters that are supported in macro name generation (supported characters can be described by the following regular expression: <code>A-Z0-9_\. </code>). So, for example, to discover MBean properties with a hyphenated word or non-ASCII characters, you need to use <code>jmx.get []</code> .
jmx.get [<discovery mode>,<object name>,<unique short de-scrip-tion>]			

**Item
key**

This item returns a JSON array with MBean objects or their attributes.

Compared to `jmx.discovery[]` it does not define LLD macros.

discovery mode - one of the following: *attributes* (retrieve JMX MBean attributes, default) or *beans* (retrieve JMX MBeans)

object name - object name pattern (see [documentation](#)) identifying the MBean names to be retrieved (empty by default, retrieving all registered beans)

unique short description - a unique description that allows multiple JMX items with the same discovery mode and object name on the host (optional)

When using this item, it is needed to define custom low-level discovery macros, pointing to values extracted from the returned JSON using `JSONPath`.

Attention:

If no parameters are passed, all MBean attributes from JMX are requested. Not specifying parameters for JMX discovery or trying to receive all attributes for a wide range like `*:type=*,name=*` may lead to potential performance problems.

Using `jmx.discovery`

This item returns a JSON object with low-level discovery macros describing MBean objects or attributes. For example, in the discovery of MBean attributes (reformatted for clarity):

```
[
  {
    "{#JMXVALUE}": "0",
    "{#JMXTYPE}": "java.lang.Long",
    "{#JMXOBJ}": "java.lang:type=GarbageCollector,name=PS Scavenge",
    "{#JMXDESC}": "java.lang:type=GarbageCollector,name=PS Scavenge,CollectionCount",
    "{#JMXATTR}": "CollectionCount"
  },
  {
    "{#JMXVALUE}": "0",
    "{#JMXTYPE}": "java.lang.Long",
    "{#JMXOBJ}": "java.lang:type=GarbageCollector,name=PS Scavenge",
    "{#JMXDESC}": "java.lang:type=GarbageCollector,name=PS Scavenge,CollectionTime",
    "{#JMXATTR}": "CollectionTime"
  },
  {
    "{#JMXVALUE}": "true",
    "{#JMXTYPE}": "java.lang.Boolean",
    "{#JMXOBJ}": "java.lang:type=GarbageCollector,name=PS Scavenge",
    "{#JMXDESC}": "java.lang:type=GarbageCollector,name=PS Scavenge,Valid",
    "{#JMXATTR}": "Valid"
  },
  {
    "{#JMXVALUE}": "PS Scavenge",
    "{#JMXTYPE}": "java.lang.String",
    "{#JMXOBJ}": "java.lang:type=GarbageCollector,name=PS Scavenge",
    "{#JMXDESC}": "java.lang:type=GarbageCollector,name=PS Scavenge,Name",
    "{#JMXATTR}": "Name"
  },
  {
    "{#JMXVALUE}": "java.lang:type=GarbageCollector,name=PS Scavenge",
    "{#JMXTYPE}": "javax.management.ObjectName",
    "{#JMXOBJ}": "java.lang:type=GarbageCollector,name=PS Scavenge",
    "{#JMXDESC}": "java.lang:type=GarbageCollector,name=PS Scavenge,ObjectName",
    "{#JMXATTR}": "ObjectName"
  }
]
```

```
]
```

In the discovery of MBeans (reformatted for clarity):

```
[
  {
    "#{JMXDOMAIN}": "java.lang",
    "#{JMXTYPE}": "GarbageCollector",
    "#{JMXOBJ}": "java.lang:type=GarbageCollector,name=PS Scavenge",
    "#{JMXNAME}": "PS Scavenge"
  }
]
```

Supported macros

The following macros are supported for use in the discovery rule **filter** and prototypes of items, triggers and graphs:

Macro	Description
Discovery of MBean attributes	
{#JMXVALUE}	Attribute value.
{#JMXTYPE}	Attribute type.
{#JMXOBJ}	Object name.
{#JMXDESC}	Object name including attribute name.
{#JMXATTR}	Attribute name.
Discovery of MBeans	
{#JMXDOMAIN}	MBean domain. (<i>Zabbix reserved name</i>)
{#JMXOBJ}	Object name. (<i>Zabbix reserved name</i>)
{#JMX<key property>}	MBean properties (like {#JMXTYPE}, {#JMXNAME}) (see Limitations below).

Limitations

There are some limitations associated with the algorithm of creating LLD macro names from MBean property names:

- attribute names are changed to uppercase
- attribute names are ignored (no LLD macros are generated) if they consist of unsupported characters for LLD macro names. Supported characters can be described by the following regular expression: A-Z0-9_\. .
- if an attribute is called "obj" or "domain" they will be ignored because of the overlap with the values of the reserved Zabbix properties {#JMXOBJ} and {#JMXDOMAIN}

Please consider this jmx.discovery (with "beans" mode) example. MBean has the following properties defined (some of which will be ignored; see below):

```
name=test
  =Type
attributes []=1,2,3
Name=NameOfTheTest
domAin=some
```

As a result of JMX discovery, the following LLD macros will be generated:

- {#JMXDOMAIN} - Zabbix internal, describing the domain of MBean
- {#JMXOBJ} - Zabbix internal, describing MBean object
- {#JMXNAME} - created from "name" property

Ignored properties are:

- тип : its name contains unsupported characters (non-ASCII)
- attributes[] : its name contains unsupported characters (square brackets are not supported)
- Name : it's already defined (name=test)
- domAin : it's a Zabbix reserved name

Examples

Let's review two more practical examples of an LLD rule creation with the use of MBean. To understand the difference between an LLD rule collecting MBeans and an LLD rule collecting MBean attributes better please take a look at following table:

MBean1	MBean2	MBean3
MBean1Attribute1	MBean2Attribute1	MBean3Attribute1

MBean1Attribute2	MBean2Attribute2	MBean3Attribute2
MBean1Attribute3	MBean2Attribute3	MBean3Attribute3

Example 1: Discovering MBeans

This rule will return 3 objects: the top row of the column: MBean1, MBean2, MBean3.

For more information about objects please refer to [supported macros](#) table, *Discovery of MBeans* section.

Discovery rule configuration collecting MBeans (without the attributes) looks like the following:

The screenshot shows the configuration for a discovery rule named 'JMX garbage collectors'. The configuration includes:

- Name:** JMX garbage collectors
- Type:** JMX agent
- Key:** `jmx.discovery[beans,"*:type=GarbageCollector,name=*"]`
- Host interface:** 127.0.0.1 : 12345

The key used here:

```
jmx.discovery[beans,"*:type=GarbageCollector,name=*"]
```

All the garbage collectors without attributes will be discovered. As Garbage collectors have the same attribute set, we can use desired attributes in item prototypes the following way:

Item prototypes

The screenshot shows the 'Item prototypes' configuration for the 'JMX garbage collectors' rule. It displays a table with the following columns: Name and Key.

Name	Key
<input type="checkbox"/> GC {#JMXNAME} CollectionCount	<code>jmx[{#JMXOBJ},CollectionCount]</code>
<input type="checkbox"/> GC {#JMXNAME} CollectionTime	<code>jmx[{#JMXOBJ},CollectionTime]</code>
<input type="checkbox"/> GC {#JMXNAME} Valid	<code>jmx[{#JMXOBJ},Valid]</code>

The keys used here:

```
jmx[{#JMXOBJ},CollectionCount]
jmx[{#JMXOBJ},CollectionTime]
jmx[{#JMXOBJ},Valid]
```

LLD discovery rule will result in something close to this (items are discovered for two Garbage collectors):

<input type="checkbox"/>	Name ▲	Triggers	Key
<input type="checkbox"/>	... JMX garbage collectors: GC PS MarkSweep CollectionCount		jmx["java.lang:type=GarbageCollector,name=PS MarkSweep",CollectionCount]
<input type="checkbox"/>	... JMX garbage collectors: GC PS MarkSweep CollectionTime		jmx["java.lang:type=GarbageCollector,name=PS MarkSweep",CollectionTime]
<input type="checkbox"/>	... JMX garbage collectors: GC PS MarkSweep Valid		jmx["java.lang:type=GarbageCollector,name=PS MarkSweep",Valid]
<input type="checkbox"/>	... JMX garbage collectors: GC PS Scavenge CollectionCount		jmx["java.lang:type=GarbageCollector,name=PS Scavenge",CollectionCount]
<input type="checkbox"/>	... JMX garbage collectors: GC PS Scavenge CollectionTime		jmx["java.lang:type=GarbageCollector,name=PS Scavenge",CollectionTime]
<input type="checkbox"/>	... JMX garbage collectors: GC PS Scavenge Valid		jmx["java.lang:type=GarbageCollector,name=PS Scavenge",Valid]

Example 2: Discovering MBean attributes

This rule will return 9 objects with the following fields: MBean1Attribute1, MBean2Attribute1, MBean3Attribute1, MBean1Attribute2, MBean2Attribute2, MBean3Attribute2, MBean1Attribute3, MBean2Attribute3, MBean3Attribute3.

For more information about objects please refer to [supported macros](#) table, *Discovery of MBean attributes* section.

Discovery rule configuration collecting MBean attributes looks like the following:

Discovery rule | Preprocessing | LLD macros | Filters | Overrides

* Name:

Type:

* Key:

* Host interface:

The key used here:

```
jmx.discovery[attributes,"*:type=GarbageCollector,name=*"]
```

All the garbage collectors with a single item attribute will be discovered.

Item prototypes

All hosts / JMX Enabled JMX Discovery list / JMX garbage collectors | **Item prototypes** | Trigger p

<input type="checkbox"/>	Name ▲	Key
<input type="checkbox"/>	{#JMXOBJ} {#JMXATTR}	jmx[{#JMXOBJ},{#JMXATTR}]

In this particular case an item will be created from prototype for every MBean attribute. The main drawback of this configuration is that trigger creation from trigger prototypes is impossible as there is only one item prototype for all attributes. So this setup can be used for data collection, but is not recommended for automatic monitoring.

Using `jmx.get`

`jmx.get []` is similar to the `jmx.discovery []` item, but it does not turn Java object properties into low-level discovery macro names and therefore can return values without **limitations** that are associated with LLD macro name generation such as hyphens or non-ASCII characters.

When using `jmx.get []` for discovery, low-level discovery macros can be defined separately in the custom **LLD macro** tab of the discovery rule configuration, using JSONPath to point to the required values.

Discovering MBeans

Discovery item: `jmx.get[beans,"com.example:type=*,*"]`

Response:

```
[
  {
    "object": "com.example:type=Hello,data-src=data-base, = ",
    "domain": "com.example",
    "properties": {
      "data-src": "data-base",
      " ": " ",
      "type": "Hello"
    }
  },
  {
    "object": "com.example:type=Atomic",
    "domain": "com.example",
    "properties": {
      "type": "Atomic"
    }
  }
]
```

Discovering MBean attributes

Discovery item: `jmx.get[attributes,"com.example:type=*,*"]`

Response:

```
[
  {
    "object": "com.example:type=*",
    "domain": "com.example",
    "properties": {
      "type": "Simple"
    }
  },
  {
    "object": "com.zabbix:type=yes,domain=zabbix.com,data-source=/dev/rand, = ,obj=true",
    "domain": "com.zabbix",
    "properties": {
      "type": "Hello",
      "domain": "com.example",
      "data-source": "/dev/rand",
      " ": " ",
      "obj": true
    }
  }
]
```

7 Discovery of IPMI sensors

Overview

It is possible to automatically discover IPMI sensors.

To do that, you may use a combination of:

- the `ipmi.get` IPMI item as the master item
- dependent low-level discovery rule and item prototypes

Configuration

Master item

Create an IPMI item using the following key:

`ipmi.get`

Item Tags Preprocessing

* Name

Type

* Key

* Host interface

IPMI sensor

Type of information

Set the type of information to "Text" for possibly big JSON data.

Dependent LLD rule

Create a low-level discovery rule as "Dependent item" type:

Discovery rule Preprocessing LLD macros Filters Overrides

* Name

Type

* Key

* Master item

As master item select the `ipmi.get` item we created.

In the "LLD macros" tab define a custom macro with the corresponding JSONPath:

Discovery rule Preprocessing LLD macros 1 Filters Overrides

LLD macros	LLD macro	JSONPath
	<input data-bbox="517 1771 1182 1832" type="text" value="{#SENSOR_ID}"/>	<input data-bbox="1198 1771 1453 1832" type="text" value="\$..id"/>
	Add	

Dependent item prototype

Create an item prototype with "Dependent item" type in this LLD rule. As master item for this prototype select the `ipmi.get` item we created.

Item prototype Tags Preprocessing

* Name

Type

* Key

* Master item

Type of information

Note the use of the {#SENSOR_ID} macro in the item prototype name and key:

- Name: IPMI value for sensor {#SENSOR_ID}
- Key: ipmi_sensor[{#SENSOR_ID}]

As type of information, *Numeric (unsigned)*.

In the item prototype "Preprocessing" tab select JSONPath and use the following JSONPath expression as parameter:

```
$. [?(@.id=='{#SENSOR_ID}')].value.first()
```

Item prototype Tags Preprocessing 1

Preprocessing steps	Name	Parameters
1:	<input type="text" value="JSONPath"/>	<input type="text" value="\$.[?(@.id=='{#SENSOR_ID}')].value.first()"/>

[Add](#)

When discovery starts, one item per each IPMI sensor will be created. This item will return the integer value of the given sensor.

8 Discovery of systemd services

Overview

It is possible to **discover** systemd units (services, by default) with Zabbix.

Item key

The item to use in the **discovery rule** is the

`systemd.unit.discovery`

Attention:

This item key is only supported in Zabbix agent 2.

This item returns a JSON with information about systemd units, for example:

```
[{
  "{#UNIT.NAME}": "mysqld.service",
  "{#UNIT.DESCRPTION}": "MySQL Server",
  "{#UNIT.LOADSTATE}": "loaded",
  "{#UNIT.ACTIVESTATE}": "active",
  "{#UNIT.SUBSTATE}": "running",
  "{#UNIT.FOLLOWED}": "",
  "{#UNIT.PATH}": "/org/freedesktop/systemd1/unit/mysqld_2eservice",
```

```

    "{#UNIT.JOBID}": 0,
    "{#UNIT.JOBTYPE}": "",
    "{#UNIT.JOBPATH}": "/",
    "{#UNIT.UNITFILESTATE}": "enabled"
    "{#UNIT.SERVICETYPE}": "simple"
}, {
    "{#UNIT.NAME}": "systemd-journald.socket",
    "{#UNIT.DESCRPTION}": "Journal Socket",
    "{#UNIT.LOADSTATE}": "loaded",
    "{#UNIT.ACTIVESTATE}": "active",
    "{#UNIT.SUBSTATE}": "running",
    "{#UNIT.FOLLOWED}": "",
    "{#UNIT.PATH}": "/org/freedesktop/systemd1/unit/systemd_2djournald_2esocket",
    "{#UNIT.JOBID}": 0,
    "{#UNIT.JOBTYPE}": "",
    "{#UNIT.JOBPATH}": "/",
    "{#UNIT.UNITFILESTATE}": "enabled"
}]

```

Discovery of disabled systemd units

It is also possible to discover **disabled** systemd units. In this case three macros are returned in the resulting JSON:

- {#UNIT.PATH}
- {#UNIT.ACTIVESTATE}
- {#UNIT.UNITFILESTATE}.

Attention:

To have items and triggers created from prototypes for disabled systemd units, make sure to adjust (or remove) prohibiting LLD filters for {#UNIT.ACTIVESTATE} and {#UNIT.UNITFILESTATE}.

Supported macros

The following macros are supported for use in the discovery rule **filter** and prototypes of items, triggers and graphs:

Macro	Description
{#UNIT.NAME}	Primary unit name.
{#UNIT.DESCRPTION}	Human readable description.
{#UNIT.LOADSTATE}	Load state (i.e. whether the unit file has been loaded successfully)
{#UNIT.ACTIVESTATE}	Active state (i.e. whether the unit is currently started or not)
{#UNIT.SUBSTATE}	Sub state (a more fine-grained version of the active state that is specific to the unit type, which the active state is not)
{#UNIT.FOLLOWED}	Unit that is being followed in its state by this unit, if there is any; otherwise an empty string.
{#UNIT.PATH}	Unit object path.
{#UNIT.JOBID}	Numeric job ID if there is a job queued for the job unit; 0 otherwise.
{#UNIT.JOBTYPE}	Job type.
{#UNIT.JOBPATH}	Job object path.
{#UNIT.UNITFILESTATE}	The install state of the unit file.
{#UNIT.SERVICETYPE}	Type of the service unit (e.g., simple, forking, oneshot, idle, etc.). This macro is returned only if the unit is a service.

Item prototypes

Item prototypes that can be created based on systemd service discovery include, for example:

- Item name: {#UNIT.DESCRPTION} active state info; item key: systemd.unit.info["{#UNIT.NAME}"]
- Item name: {#UNIT.DESCRPTION} load state info; item key: systemd.unit.info["{#UNIT.NAME}",LoadState]

9 Discovery of Windows services

Overview

In a similar way as **file systems** are discovered, it is possible to also discover Windows services.

Item key

The item to use in the **discovery rule** is

```
service.discovery
```

Supported macros

The following macros are supported for use in the discovery rule **filter** and prototypes of items, triggers and graphs:

Macro	Description
{#SERVICE.NAME}	Service name.
{#SERVICE.DISPLAYNAME}	Displayed service name.
{#SERVICE.DESCRPTION}	Service description.
{#SERVICE.STATE}	Numerical value of the service state. See the service.info item for details.
{#SERVICE.STATENAME}	Name of the service state. See the service.info item for details.
{#SERVICE.PATH}	Service path.
{#SERVICE.USER}	Service user.
{#SERVICE.STARTUP}	Numerical value of the service startup type. See the service.info item for details.
{#SERVICE.STARTUPNAME}	Name of the service startup type. See the service.info item for details.
{#SERVICE.STARTUPTRIGGER}	Numerical value to indicate if the service startup type has: 0 - no startup triggers 1 - has startup triggers It is useful to discover such service startup types as <i>Automatic (trigger start)</i> , <i>Automatic delayed (trigger start)</i> and <i>Manual (trigger start)</i> .

Based on Windows service discovery you may create an **item** prototype like

```
service.info[{#SERVICE.NAME}, <param>]
```

where **param** accepts the following values: *state*, *displayname*, *path*, *user*, *startup* or *description*.

For example, to acquire the display name of a service you may use a "service.info[{#SERVICE.NAME},displayname]" item. If **param** value is not specified ("service.info[{#SERVICE.NAME}]"), the default *state* parameter is used.

10 Discovery of Windows performance counter instances

Overview

It is possible to discover object instances of Windows performance counters. This is useful for multi-instance performance counters.

Item key

To configure the **discovery rule**, use the following item:

- `perf_instance.discovery[object]`

Note that the object name may be localized. For example:

```
perf_instance.discovery[Processor] # The object name is in English.  
perf_instance.discovery[Processador] # The object name is in Portuguese.
```

Alternatively, to ensure that the object name is provided in English, independent of OS localization, use the following item:

- `perf_instance_en.discovery[object]`

For example:

```
perf_instance_en.discovery[Processor]  
perf_instance_en.discovery[Memory]
```

Supported macros

The discovery process will return all instances of the specified object in the {#INSTANCE} macro:

```
[
  {"{#INSTANCE}": "0"},
  {"{#INSTANCE}": "1"},
  {"{#INSTANCE}": "_Total"}
]
```

This macro may be used in the prototypes of `perf_counter[]` and `perf_counter_en[]` items.

For example, if the item key used in the discovery rule is `perf_instance.discovery[Processor]`, you may create the following item prototype:

```
perf_counter["\Processor({#INSTANCE})\% Processor Time"]
```

Note:

- If the specified object is not found or does not support variable instances, the discovery item will become NOTSUPPORTED.
- If the specified object supports variable instances but currently does not have any instances, an empty JSON array will be returned.
- Duplicate instances will be skipped.

11 Discovery using WMI queries

Overview

WMI is a powerful interface in Windows that can be used for retrieving various information about Windows components, services, state and software installed.

It can be used for physical disk discovery and their performance data collection, network interface discovery, Hyper-V guest discovery, monitoring Windows services and many other things in Windows OS.

This type of low-level **discovery** is done using WQL queries whose results get automatically transformed into a JSON object suitable for low-level discovery.

Item key

The item to use in the **discovery rule** is

```
wmi.getall[<namespace>,<query>]
```

This **item** transforms the query result into a JSON array. For example:

```
select * from Win32_DiskDrive where Name like '%PHYSICALDRIVE%'
```

may return something like this:

```
[
  {
    "DeviceID" : "\\.\PHYSICALDRIVE0",
    "BytesPerSector" : 512,
    "Capabilities" : [
      3,
      4
    ],
    "CapabilityDescriptions" : [
      "Random Access",
      "Supports Writing"
    ],
    "Caption" : "VBOX HARDDISK ATA Device",
    "ConfigManagerErrorCode" : "0",
    "ConfigManagerUserConfig" : "false",
    "CreationClassName" : "Win32_DiskDrive",
    "Description" : "Disk drive",
    "FirmwareRevision" : "1.0",
    "Index" : 0,
    "InterfaceType" : "IDE"
  },
  {
    "DeviceID" : "\\.\PHYSICALDRIVE1",
    "BytesPerSector" : 512,
```

```

    "Capabilities" : [
      3,
      4
    ],
    "CapabilityDescriptions" : [
      "Random Access",
      "Supports Writing"
    ],
    "Caption" : "VBOX HARDDISK ATA Device",
    "ConfigManagerErrorCode" : "0",
    "ConfigManagerUserConfig" : "false",
    "CreationClassName" : "Win32_DiskDrive",
    "Description" : "Disk drive",
    "FirmwareRevision" : "1.0",
    "Index" : 1,
    "InterfaceType" : "IDE"
  }
]

```

Low-level discovery macros

Even though no low-level discovery macros are created in the returned JSON, these macros can be defined by the user as an additional step, using the [custom LLD macro](#) functionality with JSONPath pointing to the discovered values in the returned JSON.

The macros then can be used to create item, trigger, etc prototypes.

12 Discovery using ODBC SQL queries

Overview

This type of low-level [discovery](#) is done using SQL queries, whose results get automatically transformed into a JSON object suitable for low-level discovery.

Item key

SQL queries are performed using a "Database monitor" item type. Therefore, most of the instructions on [ODBC monitoring](#) page apply in order to get a working "Database monitor" discovery rule.

Two item keys may be used in "Database monitor" discovery rules:

- **db.odbc.discovery**[<unique short description>,<dsn>,<connection string>] - this item transforms the SQL query result into a JSON array, turning the column names from the query result into low-level discovery macro names paired with the discovered field values. These macros can be used in creating item, trigger, etc prototypes. See also: [Using db.odbc.discovery](#).
- **db.odbc.get**[<unique short description>,<dsn>,<connection string>] - this item transforms the SQL query result into a JSON array, keeping the original column names from the query result as a field name in JSON paired with the discovered values. Compared to `db.odbc.discovery[]`, this item does not create low-level discovery macros in the returned JSON, therefore there is no need to check if the column names can be valid macro names. The low-level discovery macros can be defined as an additional step as required, using the [custom LLD macro](#) functionality with JSONPath pointing to the discovered values in the returned JSON. See also: [Using db.odbc.get](#).

Using db.odbc.discovery

As a practical example to illustrate how the SQL query is transformed into JSON, let us consider low-level discovery of Zabbix proxies by performing an ODBC query on Zabbix database. This is useful for automatic creation of "zabbix[proxy,<name>,lastaccess]" [internal items](#) to monitor which proxies are alive.

Let us start with discovery rule configuration:

Discovery rule Preprocessing LLD macros Filters Overrides

* Name

Type

* Key

User name

Password

* SQL query

* Update interval

All mandatory input fields are marked with a red asterisk.

Here, the following direct query on Zabbix database is used to select all Zabbix proxies, together with the number of hosts they are monitoring. The number of hosts can be used, for instance, to filter out empty proxies:

```
mysql> SELECT h1.host, COUNT(h2.host) AS count FROM hosts h1 LEFT JOIN hosts h2 ON h1.hostid = h2.proxy_hostid
+-----+-----+
| host   | count |
+-----+-----+
| Japan 1 |    5 |
| Japan 2 |   12 |
| Latvia |    3 |
+-----+-----+
3 rows in set (0.01 sec)
```

By the internal workings of "db.odbc.discovery[,{\$DSN}]" item, the result of this query gets automatically transformed into the following JSON:

```
[
  {
    "#HOST": "Japan 1",
    "#COUNT": "5"
  },
  {
    "#HOST": "Japan 2",
    "#COUNT": "12"
  },
  {
    "#HOST": "Latvia",
    "#COUNT": "3"
  }
]
```

It can be seen that column names become macro names and selected rows become the values of these macros.

Note:

If it is not obvious how a column name would be transformed into a macro name, it is suggested to use column aliases like "COUNT(h2.host) AS count" in the example above.

In case a column name cannot be converted into a valid macro name, the discovery rule becomes not supported, with the error message detailing the offending column number. If additional help is desired, the obtained column names are provided under DebugLevel=4 in Zabbix server log file:

```

$ grep db.odbc.discovery /tmp/zabbix_server.log
...
23876:20150114:153410.856 In db_odbc_discovery() query:'SELECT h1.host, COUNT(h2.host) FROM hosts h1 I
23876:20150114:153410.860 db_odbc_discovery() column[1]:'host'
23876:20150114:153410.860 db_odbc_discovery() column[2]:'COUNT(h2.host) '
23876:20150114:153410.860 End of db_odbc_discovery():NOTSUPPORTED
23876:20150114:153410.860 Item [Zabbix server:db.odbc.discovery[proxies,{$DSN}]] error: Cannot convert

```

Now that we understand how a SQL query is transformed into a JSON object, we can use {#HOST} macro in item prototypes:

Item prototype	Tags	Preprocessing
* Name	Last access time of proxy {#HOST}	
Type	Zabbix internal	
* Key	zabbix[proxy,{#HOST},lastaccess]	
Type of information	Numeric (unsigned)	
Units	unixtime	
* Update interval	60s	

Once discovery is performed, an item will be created for each proxy:

<input type="checkbox"/>	Name	Triggers	Key ▲
<input type="checkbox"/>	... Proxy discovery: Last access time of proxy Japan1		zabbix[proxy,Japan1,lastacce
<input type="checkbox"/>	... Proxy discovery: Last access time of proxy Japan2		zabbix[proxy,Japan2,lastacce
<input type="checkbox"/>	... Proxy discovery: Last access time of proxy Latvia		zabbix[proxy,Latvia,lastaccess

Using db.odbc.get

Using db.odbc.get [, {\$DSN}] and the following SQL example:

```

mysql> SELECT h1.host, COUNT(h2.host) AS count FROM hosts h1 LEFT JOIN hosts h2 ON h1.hostid = h2.proxy_ho
+-----+-----+
| host   | count |
+-----+-----+
| Japan 1 |     5 |
| Japan 2 |    12 |
| Latvia |     3 |
+-----+-----+
3 rows in set (0.01 sec)

```

this JSON will be returned:

```

[
  {

```

```

    "host": "Japan 1",
    "count": "5"
  },
  {
    "host": "Japan 2",
    "count": "12"
  },
  {
    "host": "Latvia",
    "count": "3"
  }
]

```

As you can see, there are no low-level discovery macros there. However, custom low-level discovery macros can be created in the **LLD macros** tab of a discovery rule using JSONPath, for example:

```
{#HOST} → $.host
```

Now this {#HOST} macro may be used in item prototypes:

Item prototype	Tags	Preprocessing
* Name	Last access time of proxy {#HOST}	
Type	Zabbix internal	
* Key	zabbix[proxy,{#HOST},lastaccess]	
Type of information	Numeric (unsigned)	
Units	unixtime	
* Update interval	60s	

13 Discovery using Prometheus data

Overview

Data provided in Prometheus line format can be used for low-level discovery.

See **Prometheus checks** for details how Prometheus data querying is implemented in Zabbix.

Configuration

The low-level discovery rule should be created as a **dependent item** to the HTTP master item that collects Prometheus data.

Prometheus to JSON

In the discovery rule, go to the Preprocessing tab and select the *Prometheus to JSON* preprocessing option. Data in JSON format are needed for discovery and the *Prometheus to JSON* preprocessing option will return exactly that, with the following attributes:

- metric name
- metric value
- help (if present)
- type (if present)
- labels (if present)
- raw line

For example, querying `wmi_logical_disk_free_bytes`:

Discovery rule Preprocessing 1 LLD macros Filters Overrides

Preprocessing steps	Name	Parameters
1:	Prometheus to JSON	wmi_logical_disk_free_bytes{volume=~".*"} Add

from these Prometheus lines:

```
# HELP wmi_logical_disk_free_bytes Free space in bytes (LogicalDisk.PercentFreeSpace)
# TYPE wmi_logical_disk_free_bytes gauge
wmi_logical_disk_free_bytes{volume="C:"} 3.5180249088e+11
wmi_logical_disk_free_bytes{volume="D:"} 2.627731456e+09
wmi_logical_disk_free_bytes{volume="HarddiskVolume4"} 4.59276288e+08
```

will return:

```
[
  {
    "name": "wmi_logical_disk_free_bytes",
    "help": "Free space in bytes (LogicalDisk.PercentFreeSpace)",
    "type": "gauge",
    "labels": {
      "volume": "C:"
    },
    "value": "3.5180249088e+11",
    "line_raw": "wmi_logical_disk_free_bytes{volume=\"C:\"} 3.5180249088e+11"
  },
  {
    "name": "wmi_logical_disk_free_bytes",
    "help": "Free space in bytes (LogicalDisk.PercentFreeSpace)",
    "type": "gauge",
    "labels": {
      "volume": "D:"
    },
    "value": "2.627731456e+09",
    "line_raw": "wmi_logical_disk_free_bytes{volume=\"D:\"} 2.627731456e+09"
  },
  {
    "name": "wmi_logical_disk_free_bytes",
    "help": "Free space in bytes (LogicalDisk.PercentFreeSpace)",
    "type": "gauge",
    "labels": {
      "volume": "HarddiskVolume4"
    },
    "value": "4.59276288e+08",
    "line_raw": "wmi_logical_disk_free_bytes{volume=\"HarddiskVolume4\"} 4.59276288e+08"
  }
]
```

Mapping LLD macros

Next you have to go to the LLD macros tab and make the following mappings:

```
{#VOLUME}=${.labels['volume']}
{#METRIC}=${['name']}
{#HELP}=${['help']}
```

Item prototype

You may want to create an item prototype like this:

Item prototype Tags Preprocessing

* Name

Type

* Key

Type of information

* Master item

Units

* History

* Trends

Value mapping

Description

Create enabled

Discover

with preprocessing options:

Item prototype Tags Preprocessing 1

Preprocessing steps	Name	Parameters
1:	Prometheus pattern	{#METRIC}{volume="{#VOLUME}"}

[Add](#)

14 Discovery of block devices

In a similar way as **file systems** are discovered, it is possible to also discover block devices and their type.

Item key

The item key to use in the **discovery rule** is

`vfs.dev.discovery`

This item is supported on Linux platforms only.

You may create discovery rules using this discovery item and:

- filter: **{#DEVNAME}** matches `sd[\D]$` - to discover devices named "sd0", "sd1", "sd2", ...
- filter: **{#DEVTYPE}** matches `disk` AND **{#DEVNAME}** does not match `^loop.*` - to discover disk type devices whose name does not start with "loop"

Supported macros

This discovery key returns two macros - `{#DEVNAME}` and `{#DEVTYPE}` identifying the block device name and type respectively, e.g.:

```
[
  {
    "{#DEVNAME}": "loop1",
    "{#DEVTYPE}": "disk"
  },
  {
    "{#DEVNAME}": "dm-0",
```



```

    "{#DEVTYPE}": "disk"
  },
  {
    "{#DEVNAME}": "sda",
    "{#DEVTYPE}": "disk"
  },
  {
    "{#DEVNAME}": "sda1",
    "{#DEVTYPE}": "partition"
  }
]

```

Block device discovery allows to use `vfs.dev.read[]` and `vfs.dev.write[]` items to create item prototypes using the `{#DEVNAME}` macro, for example:

- `"vfs.dev.read[{#DEVNAME},sps]"`
- `"vfs.dev.write[{#DEVNAME},sps]"`

`{#DEVTYPE}` is intended for device filtering.

15 Discovery of host interfaces in Zabbix

Overview

It is possible to **discover** all interfaces configured in Zabbix frontend for a host.

Item key

The item to use in the **discovery rule** is the

`zabbix[host,discovery,interfaces]`

internal item.

This item returns a JSON with the description of interfaces, including:

- IP address/DNS hostname (depending on the “Connect to” host setting)
- Port number
- Interface type (Zabbix agent, SNMP, JMX, IPMI)
- If it is the default interface or not
- If the bulk request feature is enabled - for SNMP interfaces only.

For example:

```
[{"{#IF.CONN}": "192.168.3.1", "{#IF.IP}": "192.168.3.1", "{#IF.DNS}": "", "{#IF.PORT}": "10050", "{#IF.TYPE}": "AG
```

With multiple interfaces their records in JSON are ordered by:

- Interface type,
- Default - the default interface is put before non-default interfaces,
- Interface ID (in ascending order).

Supported macros

The following macros are supported for use in the discovery rule **filter** and prototypes of items, triggers and graphs:

Macro	Description
<code>{#IF.CONN}</code>	Interface IP address or DNS host name.
<code>{#IF.IP}</code>	Interface IP address.
<code>{#IF.DNS}</code>	Interface DNS host name.
<code>{#IF.PORT}</code>	Interface port number.
<code>{#IF.TYPE}</code>	Interface type (“AGENT”, “SNMP”, “JMX”, or “IPMI”).
<code>{#IF.DEFAULT}</code>	Default status for the interface: 0 - not default interface 1 - default interface
<code>{#IF.SNMP.BULK}</code>	SNMP bulk processing status for the interface: 0 - disabled 1 - enabled This macro is returned only if interface type is “SNMP”.

7 Custom LLD rules

Overview

It is also possible to create a completely custom LLD rule, discovering any type of entities - for example, databases on a database server.

To do so, a custom item should be created that returns JSON, specifying found objects and optionally - some properties of them. The amount of macros per entity is not limited - while the built-in discovery rules return either one or two macros (for example, two for filesystem discovery), it is possible to return more.

Example

The required JSON format is best illustrated with an example. Suppose we are running an old Zabbix 1.8 agent (one that does not support "vfs.fs.discovery"), but we still need to discover file systems. Here is a simple Perl script for Linux that discovers mounted file systems and outputs JSON, which includes both file system name and type. One way to use it would be as a UserParameter with key "vfs.fs.discovery_perl":

```
####!/usr/bin/perl

$first = 1;

print "[\n";

for (`cat /proc/mounts`)
{
    ($fsname, $fstype) = m/\S+ (\S+) (\S+)/;

    print "\t,\n" if not $first;
    $first = 0;

    print "\t{\n";
    print "\t\t\t\"#{FSNAME}\" : \"$fsname\", \n";
    print "\t\t\t\"#{FSTYPE}\" : \"$fstype\" \n";
    print "\t}\n";
}

print "]\n";
```

Attention:

Allowed symbols for LLD macro names are **0-9** , **A-Z** , **_** , **.** Lowercase letters are not supported in the names.

An example of its output (reformatted for clarity) is shown below. JSON for custom discovery checks has to follow the same format.

```
[
  { "#{FSNAME}": "/",           "#{FSTYPE}": "rootfs" },
  { "#{FSNAME}": "/sys",       "#{FSTYPE}": "sysfs" },
  { "#{FSNAME}": "/proc",     "#{FSTYPE}": "proc" },
  { "#{FSNAME}": "/dev",      "#{FSTYPE}": "devtmpfs" },
  { "#{FSNAME}": "/dev/pts",   "#{FSTYPE}": "devpts" },
  { "#{FSNAME}": "/lib/init/rw", "#{FSTYPE}": "tmpfs" },
  { "#{FSNAME}": "/dev/shm",  "#{FSTYPE}": "tmpfs" },
  { "#{FSNAME}": "/home",     "#{FSTYPE}": "ext3" },
  { "#{FSNAME}": "/tmp",      "#{FSTYPE}": "ext3" },
  { "#{FSNAME}": "/usr",      "#{FSTYPE}": "ext3" },
  { "#{FSNAME}": "/var",      "#{FSTYPE}": "ext3" },
  { "#{FSNAME}": "/sys/fs/fuse/connections", "#{FSTYPE}": "fusectl" }
]
```

In the previous example it is required that the keys match the LLD macro names used in prototypes, the alternative is to extract LLD macro values using JSONPath `{#FSNAME} → $.fsname` and `{#FSTYPE} → $.fstype`, thus making such script possible:

```
####!/usr/bin/perl

$first = 1;
```

```

print "[\n";

for (`cat /proc/mounts`)
{
    ($fsname, $fstype) = m/\S+ (\S+) (\S+)/;

    print "\t,\n" if not $first;
    $first = 0;

    print "\t{\n";
    print "\t\t\"fsname\": \"$fsname\", \n";
    print "\t\t\"fstype\": \"$fstype\" \n";
    print "\t}\n";
}

print "]\n";

```

An example of its output (reformatted for clarity) is shown below. JSON for custom discovery checks has to follow the same format.

```

[
  { "fsname": "/", "fstype": "rootfs" },
  { "fsname": "/sys", "fstype": "sysfs" },
  { "fsname": "/proc", "fstype": "proc" },
  { "fsname": "/dev", "fstype": "devtmpfs" },
  { "fsname": "/dev/pts", "fstype": "devpts" },
  { "fsname": "/lib/init/rw", "fstype": "tmpfs" },
  { "fsname": "/dev/shm", "fstype": "tmpfs" },
  { "fsname": "/home", "fstype": "ext3" },
  { "fsname": "/tmp", "fstype": "ext3" },
  { "fsname": "/usr", "fstype": "ext3" },
  { "fsname": "/var", "fstype": "ext3" },
  { "fsname": "/sys/fs/fuse/connections", "fstype": "fusectl" }
]

```

Then, in the discovery rule's "Filter" field, we could specify "{#FSTYPE}" as a macro and "rootfs|ext3" as a regular expression.

Note:

You don't have to use macro names FSNAME/FSTYPE with custom LLD rules, you are free to use whatever names you like. In case JSONPath is used then LLD row will be an array element that can be an object, but it can be also another array or a value.

Note that, if using a user parameter, the return value is limited to 16MB. For more details, see [data limits for LLD return values](#).

16 Distributed monitoring

Overview Zabbix provides an effective and reliable way of monitoring a distributed IT infrastructure using Zabbix [proxies](#).

Proxies can be used to collect data locally on behalf of a centralized Zabbix server and then report the data to the server.

Proxy features

When making a choice of using/not using a proxy, several considerations must be taken into account.

	Proxy
<i>Lightweight</i>	Yes
<i>GUI</i>	No
<i>Works independently</i>	Yes
<i>Easy maintenance</i>	Yes
<i>Automatic DB creation</i>	Yes ¹
<i>Local administration</i>	No
<i>Ready for embedded hardware</i>	Yes

	Proxy
One way TCP connections	Yes
Centralized configuration	Yes
Generates notifications	No

¹ Automatic DB creation feature works only with SQLite. Other supported databases require **manual setup**.

1 Proxies

Overview A Zabbix proxy can collect performance and availability data on behalf of the Zabbix server. This way, a proxy can take on itself some of the load of collecting data and offload the Zabbix server.

Also, using a proxy is the easiest way of implementing centralized and distributed monitoring, when all agents and proxies report to one Zabbix server and all data is collected centrally.

A Zabbix proxy can be used to:

- Monitor remote locations
- Monitor locations having unreliable communications
- Offload the Zabbix server when monitoring thousands of devices
- Simplify the maintenance of distributed monitoring

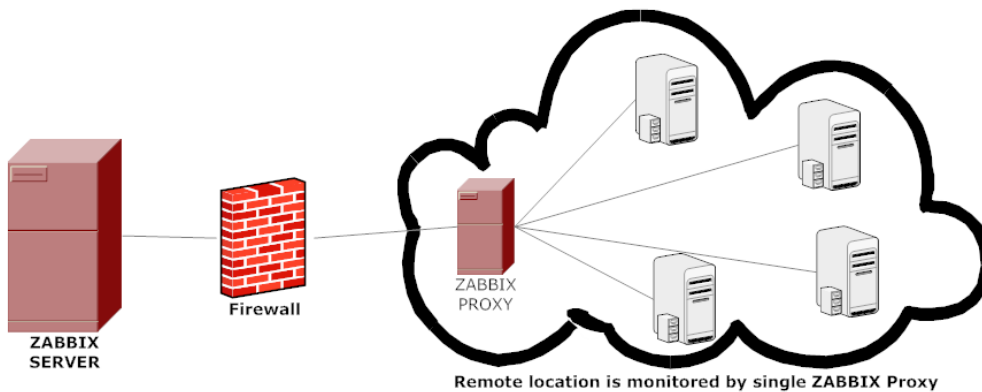

The proxy requires only one TCP connection to the Zabbix server. This way it is easier to get around a firewall as you only need to configure one firewall rule.

Attention:

Zabbix proxy must use a separate database. Pointing it to the Zabbix server database will break the configuration.

All data collected by the proxy is stored locally before transmitting it over to the server. This way no data is lost due to any temporary communication problems with the server. The *ProxyLocalBuffer* and *ProxyOfflineBuffer* parameters in the **proxy configuration file** control for how long the data are kept locally.

Attention:

It may happen that a proxy, which receives the latest configuration changes directly from Zabbix server database, has a more up-to-date configuration than Zabbix server whose configuration may not be updated as fast due to the value of **CacheUpdateFrequency**. As a result, proxy may start gathering data and send them to Zabbix server that ignores these data.

Zabbix proxy is a data collector. It does not calculate triggers, process events or send alerts. For an overview of what proxy functionality is, review the following table:

Function	Supported by proxy
Items	
<i>Zabbix agent checks</i>	Yes
<i>Zabbix agent checks (active)</i>	Yes ¹
<i>Simple checks</i>	Yes

Function	Supported by proxy
<i>Trapper items</i>	Yes
<i>SNMP checks</i>	Yes
<i>SNMP traps</i>	Yes
<i>IPMI checks</i>	Yes
<i>JMX checks</i>	Yes
<i>Log file monitoring</i>	Yes
<i>Internal checks</i>	Yes
<i>SSH checks</i>	Yes
<i>Telnet checks</i>	Yes
<i>External checks</i>	Yes
<i>Dependent items</i>	Yes
<i>Script items</i>	Yes
<i>Browser items</i>	Yes
Built-in web monitoring	Yes
Item value preprocessing	Yes
Network discovery	Yes
Active agent autoregistration	Yes
Low-level discovery	Yes
Remote commands	Yes
Calculating triggers	<i>No</i>
Processing events	<i>No</i>
Event correlation	<i>No</i>
Sending alerts	<i>No</i>

Note:

[1] To make sure that an agent asks the proxy (and not the server) for active checks, the proxy must be listed in the **ServerActive** parameter in the agent configuration file.

Protection from overloading

If Zabbix server was down for some time, and proxies have collected a lot of data, and then the server starts, it may get overloaded (history cache usage stays at 95-100% for some time). This overload could result in a performance hit, where checks are processed slower than they should. Protection from this scenario was implemented to avoid problems that arise due to overloading history cache.

When Zabbix server history cache is full the history cache write access is being throttled, stalling server data gathering processes. The most common history cache overload case is after server downtime when proxies are uploading gathered data. To avoid this proxy throttling was added (currently it cannot be disabled).

Zabbix server will stop accepting data from proxies when history cache usage reaches 80%. Instead those proxies will be put on a throttling list. This will continue until the cache usage falls down to 60%. Now server will start accepting data from proxies one by one, defined by the throttling list. This means the first proxy that attempted to upload data during the throttling period will be served first and until it's done the server will not accept data from other proxies.

This throttling mode will continue until either cache usage hits 80% again or falls down to 20% or the throttling list is empty. In the first case the server will stop accepting proxy data again. In the other two cases the server will start working normally, accepting data from all proxies.

The above information can be illustrated in the following table:

History write cache usage	Zabbix server mode	Zabbix server action
Reaches 80%	Wait	Stops accepting proxy data, but maintains a <i>throttling list</i> (prioritized list of proxies to be contacted later).
Drops to 60%	Throttled	Starts processing the throttling list, but still not accepting proxy data.
Drops to 20%	Normal	Drops the throttling list and starts accepting proxy data normally.

You may use the `zabbix[wcache,history,pused]` internal item to correlate this behavior of Zabbix server with a metric.

Configuration Once you have **installed** and **configured** a proxy, it is time to configure it in the Zabbix frontend.

Adding proxies

To configure a proxy in Zabbix frontend:

- Go to: *Administration* → *Proxies*
- Click on *Create proxy*

New proxy
? X

Proxy
Encryption
Timeouts

* Proxy name

Proxy group Riga X Select

* Address for active agents

Address	Port
192.0.2.0	10051

Proxy mode Active Passive

Proxy address

Description

Add
Cancel

Parameter	Description
<i>Proxy name</i>	Enter the proxy name. It must be the same name as in the <i>Hostname</i> parameter in the proxy configuration file.
<i>Proxy group</i>	Select the proxy group for proxy load balancing/high availability . Only one group can be selected.
<i>Address for active agents</i>	Enter address the monitored active agents or senders must connect to. Supported only for Zabbix 7.0 agents or later.
<i>Address</i>	IP address/DNS name to connect to.
<i>Port</i>	TCP port number (10051 by default) to connect to. User macros are supported.
<i>Proxy mode</i>	Select the proxy mode. Active - the proxy will connect to the Zabbix server and request configuration data Passive - Zabbix server connects to the proxy <i>Note</i> that without encrypted communications (sensitive) proxy configuration data may become available to parties having access to the Zabbix server trapper port when using an active proxy. This is possible because anyone may pretend to be an active proxy and request configuration data if authentication does not take place or proxy addresses are not limited in the <i>Proxy address</i> field.
<i>Proxy address</i>	If specified then active proxy requests are only accepted from this list of comma-delimited IP addresses, optionally in CIDR notation, or DNS names of active Zabbix proxy. This field is only available if an active proxy is selected in the <i>Proxy mode</i> field. Macros are not supported.
<i>Interface</i>	Enter interface details for a passive proxy. This field is only available if a passive proxy is selected in the <i>Proxy mode</i> field.
<i>Address</i>	IP address/DNS name of the passive proxy.
<i>Port</i>	TCP port number of the passive proxy (10051 by default). User macros are supported.
<i>Description</i>	Enter the proxy description.

The **Encryption** tab allows you to require encrypted connections with the proxy.

Parameter	Description
<i>Connections to proxy</i>	How the server connects to the passive proxy: no encryption (default), using PSK (pre-shared key) or certificate.
<i>Connections from proxy</i>	Select what type of connections are allowed from the active proxy. Several connection types can be selected at the same time (useful for testing and switching to other connection type). Default is "No encryption".
<i>Issuer</i>	Allowed issuer of certificate. Certificate is first validated with CA (certificate authority). If it is valid, signed by the CA, then the <i>Issuer</i> field can be used to further restrict allowed CA. This field is optional, intended to use if your Zabbix installation uses certificates from multiple CAs.
<i>Subject</i>	Allowed subject of certificate. Certificate is first validated with CA. If it is valid, signed by the CA, then the <i>Subject</i> field can be used to allow only one value of <i>Subject</i> string. If this field is empty then any valid certificate signed by the configured CA is accepted.
<i>PSK identity</i>	Pre-shared key identity string. Do not put sensitive information in the PSK identity, it is transmitted unencrypted over the network to inform a receiver which PSK to use.
<i>PSK</i>	Pre-shared key (hex-string). Maximum length: 512 hex-digits (256-byte PSK) if Zabbix uses GnuTLS or OpenSSL library, 64 hex-digits (32-byte PSK) if Zabbix uses mbed TLS (PolarSSL) library. Example: 1f87b595725ac58dd977beef14b97461a7c1045b9a1c963065002c5473194952

The **Timeouts** tab allows you to override **global** timeouts for item types that support it.

New proxy
? X

Proxy
Encryption
Timeouts ●

Timeouts for item types

Global
Override
Global timeouts

* Zabbix agent	3s
* Simple check	3s
* SNMP agent	3s
* External check	3s
* Database monitor	3s
* HTTP agent	3s
* SSH agent	3s
* TELNET agent	3s
* Script	3s
* Browser	60s

Add
Cancel

Parameter	Description
<i>Timeouts for item types</i>	<p>Select the timeout option:</p> <p>Global - global timeout is used (displayed in the grayed out <i>Timeout</i> field for each item type);</p> <p>Override - custom timeout is used (set in the <i>Timeout</i> field for each item type). Allowed range: 1 - 600s (default: inherited from global timeouts). Time suffixes, e.g. 30s, 1m, and user macros are supported.</p> <p>Clicking the <i>Global timeouts</i> link allows you to configure global timeouts. Note that the <i>Global timeouts</i> link is visible only to users of <i>Super admin</i> type with permissions to the <i>Administration</i> → <i>General</i> frontend section.</p> <p>Supported item types:</p> <ul style="list-style-type: none"> - Zabbix agent (both passive and active checks) - Simple check (except <i>icmping*</i>, <i>vmware.*</i> items) - SNMP agent (only for SNMP walk [OID] and get [OID] items) - External check - Database monitor - HTTP agent - SSH agent - TELNET agent - Script - Browser <p>Note that the timeouts set under Override will prevail over the global ones but will be overridden by individual item timeouts if those are set under item configuration.</p>

Note:

If proxy major version does not match server major version,  icon will be displayed next to *Timeouts for item types*, with the hover message "Timeouts disabled because the proxy and server versions do not match". In such cases, the proxy will use the **Timeout** parameter from the proxy configuration file.

The editing form of an existing proxy has the following additional buttons:

- *Refresh configuration* - refresh configuration of the proxy
- *Clone* - create a new proxy based on the properties of the existing proxy
- *Delete* - delete the proxy

Host configuration

You can specify that an individual host should be monitored by a proxy or proxy group in the **host configuration** form, using the *Monitored by* field.

Monitored by

Host **mass update** is another way of specifying that hosts should be monitored by a proxy or proxy group.

1 Synchronization of monitoring configuration

Overview

This page provides details on the monitoring configuration update for the proxy, i.e. how changes made to the monitoring configuration on the server are synchronized to the proxy.

Incremental update

The proxy configuration update is incremental. During a configuration sync only the modified entities are updated (thus, if no entities have been modified, nothing will be sent). This approach allows to save resources and set a smaller interval (almost instant) for the proxy configuration update.

Proxy configuration changes are tracked using revision numbers. Only entities with revisions larger than the proxy configuration revision are included in configuration data sent to the proxy.

The entities for a configuration sync are as follows:

Entity	Details
<i>autoregistration tls data</i>	All autoregistration TLS data.
<i>expressions</i>	All expressions (regular expressions, expression tables).
<i>global configuration</i>	Global configuration defined in the 'config' table
<i>host</i>	All properties, interfaces, inventory, items, item preprocessing, item parameters, web scenarios of a host.
<i>host macros</i>	All macros defined on a host and all template IDs linked to it.
<i>proxy discovery rule</i>	Discovery rules and checks assigned to a proxy.

That means:

- If an item is changed on a **host**, all configuration of that host will be synced.
- If a **regular expression** is changed, all regular expressions will be synced.

An exception are the host macros which are sent also if anything on the host has been changed.

The `-R config_cache_reload` command on the proxy will also initiate an incremental update.

Note that a full configuration sync will take place on a proxy start/restart, HA failover, if the session token has changed, or if the configuration update failed on the proxy, for example, if the connection was broken while receiving configuration data.

Configuration parameters

The **ProxyConfigFrequency** parameter determines how often the proxy configuration is synced with the server (10 seconds by default).

Note that ProxyConfigFrequency is:

- server parameter for passive proxies
- proxy parameter for active proxies

On active proxies ProxyConfigFrequency is a new parameter since Zabbix 6.4 and must be used instead of the now-deprecated ConfigFrequency.

Attention:

If both ProxyConfigFrequency and ConfigFrequency are used, the proxy will log an error and terminate.

2 Proxy load balancing and high availability

Overview

Proxy load balancing allows monitoring hosts by a proxy group with automated distribution of hosts between proxies and high proxy availability.

If one proxy from the proxy group goes offline, its hosts will be immediately distributed among other proxies having the least assigned hosts in the group. Or, if a proxy has too many/too few hosts compared to the group average, group re-balancing by distributing hosts evenly will be triggered.

Host redistribution happens only in online proxy groups. A proxy group is "online" if the configured minimum number of its proxies are online (not offline or unknown).

Note:

The minimum number of online proxies should be less than the proxy total in the group. In a group of 10 proxies, setting the minimum online proxy count to 10 creates a situation where the whole group will go offline if only one proxy fails. It is better to have 6 online proxies required. This will support 4 unhealthy proxies.

The proxy state is:

- **online** - if there was communication with it for the **failover delay** period (passive proxy responded to server requests and active proxy sent a request to server);
- **offline** - if there was no communication with it for the failover delay period;
- **unknown** - after proxy creation or server start.

You can monitor the proxy group state with the `zabbix[proxy group,<name>,state]` and `zabbix[proxy group,discovery]` internal items.

Proxy load balancing and high availability is managed by the `proxy group manager` process. The proxy group manager always knows which other proxies are healthy or unhealthy.

Version compatibility

- Only Zabbix agents 7.0 and later are supported for working with proxy groups in active mode;
- Zabbix pre-7.0 version proxies and the hosts monitored by these proxies are excluded from re-balancing operations until they are upgraded.

Host reassignment

Zabbix server checks the balance between host assignments to the proxies. The group is considered "out of balance" if there is:

- **host excess** - a proxy has many more hosts than the group average;
- **host deficit** - a proxy has far fewer hosts than the group average.

The group is considered "out of balance" if the number of hosts assigned to the proxy is above/below the group average by at least **10** and a factor of **2**. In this case the group is marked by the server for host reassignment after the grace period (10 x failover delay), if the balance is not restored.

The following table illustrates with example numbers when host reassignment is (or is not) triggered:

Number of hosts on proxy	Group average	Host reassignment
100	50	Yes
60	50	No
40	50	No
25	50	Yes
15	5	Yes
10	5	No

The proxy group manager will re-distribute hosts in proxy groups in the following way:

- calculate the average number of proxies per host;
- for proxies with host excess - move excess hosts to unassigned hosts;
- for proxies with host deficit - calculate the number of hosts needed to balance proxies;
- remove the missing number of hosts from proxies with most hosts;
- distribute unassigned hosts between proxies with least hosts.

Using Zabbix sender with proxy groups

Use the `-g` option when sending values from different hosts in the input file to a proxy in proxy group to avoid some of the values being sent to the wrong proxy.

Configuring proxy load balancing

To configure proxy load balancing for monitoring hosts:

1. Create a proxy group (see "Configuring a proxy group" below).

For passive checks, all proxies of the group must be listed in the `Server` parameter of agents.

Adding all proxies of the group to the `ServerActive` agent parameter (separated by a **semicolon**) of monitored hosts is beneficial, but not mandatory. An active agent can have a single proxy in the `ServerActive` field and proxy load balancing will work. When the agent service starts, the agent will receive a full list of all IP addresses of all Zabbix proxies, load and keep into memory. Active checks (and Zabbix sender data requests) will be redirected to the correct online proxy for the host, based on the current proxy-host assignment.

Warning:

Having only a single proxy in `ServerActive` field may lead to lost monitoring data if the agent is started/rebooted while that particular proxy is offline.

2. Make sure the proxy group is online.
3. Configure that hosts are monitored by proxy group (not individual proxies). You may use host `mass update` to move hosts from proxy to the proxy group.

Attention:

Hosts monitored by a single proxy (even if it belongs to a proxy group) are not involved in load balancing/high availability. Additionally, having fewer than 10 hosts assigned to a proxy group may lead to uneven host distribution among proxies in the group.

- Wait a few seconds for configuration update and for host distribution among proxies in the proxy group. Observe the change by refreshing the host list in *Monitoring -> Hosts*.

When a host is created based on auto registration/network discovery data from a proxy belonging to proxy group - then this host is set to be monitored by this proxy group.

Limitations

- SNMP traps are not supported by proxies in proxy group.
- Checks depending on external configuration must have the same configuration on all proxies in proxy group. That includes:
 - external checks - scripts;
 - database checks - ODBC configuration.
- When using the "Database monitoring" item, the DB object/server must have extended permissions.
- When monitored in proxy group the VMware hosts will be randomly spread between proxies in the group and will cause each proxy to cache all VMware data causing additional load to vCenter.

Possible firewall issues

Agents must always be allowed to reach all proxies at the firewall level. Consider the following scenarios:

- In Zabbix agent active checks, on agent startup, the first proxy responds and redirects to another proxy. The other proxy is not reachable because of a firewall problem and the communication stops in a state of waiting for the other proxy to respond. The root cause of this situation is that the first proxy knew that the other proxy was healthy for sure. This is not a problem if the first proxy fails; then it will try different addresses configured in the "ServerActive" parameter.
- The HA setup has been stable for multiple months. Host rebalancing never happens; it is not needed. The agent does not need to validate the "backup" channel to any other proxies. In a failover scenario, it might fail because a firewall was modified half a year ago.

Configuring a proxy group

To configure a proxy group in Zabbix frontend:

- Go to: *Administration -> Proxy groups*
- Click on *Create proxy group*

Parameter	Description
<i>Name</i>	Enter the proxy group name.
<i>Failover period</i>	Enter the period in seconds before failover is executed (1m by default; allowed range 10s-15m). Time suffixes are supported (e.g., 30s, 1m). User macros are supported.
<i>Minimum number of proxies</i>	Enter the minimum number of online proxies required for the group to be online (1 by default; allowed range 1-1000). User macros are supported.
<i>Description</i>	Enter the proxy group description.

Parameter	Description
<i>Proxies</i>	List of proxies in the group. Up to five proxies can be displayed (as links or in plain text, depending on permissions to the proxy). This list is displayed when editing an existing proxy group, if there is at least one proxy in the group.

17 Encryption

Overview Zabbix supports encrypted communications between Zabbix components using Transport Layer Security (TLS) protocol v.1.2 and 1.3 (depending on the crypto library). Certificate-based and pre-shared key-based encryption is supported.

Encryption can be configured for connections:

- Between Zabbix server, Zabbix proxy, Zabbix agent, Zabbix web service, `zabbix_sender` and `zabbix_get` utilities
- To Zabbix database [from Zabbix frontend and server/proxy](#)

Encryption is optional and configurable for individual components:

- Some proxies and agents can be configured to use certificate-based encryption with the server, while others can use pre-shared key-based encryption, and yet others continue with unencrypted communications (as before)
- Server (proxy) can use different encryption configurations for different hosts

Zabbix daemon programs use one listening port for encrypted and unencrypted incoming connections. Adding an encryption does not require opening new ports on firewalls.

Limitations

- Private keys are stored in plain text in files readable by Zabbix components during startup
- Pre-shared keys are entered in Zabbix frontend and stored in Zabbix database in plain text
- Built-in encryption does not protect communications:
 - Between the web server running Zabbix frontend and user web browser
 - Between Zabbix frontend and Zabbix server
- Currently each encrypted connection opens with a full TLS handshake, no session caching and tickets are implemented
- Adding encryption increases the time for item checks and actions, depending on network latency:
 - For example, if packet delay is 100ms then opening a TCP connection and sending unencrypted request takes around 200ms. With encryption about 1000 ms are added for establishing the TLS connection;
 - Timeouts may need to be increased, otherwise some items and actions running remote scripts on agents may work with unencrypted connections, but fail with timeout with encrypted.
- Encryption is not supported by [network discovery](#). Zabbix agent checks performed by network discovery will be unencrypted and if Zabbix agent is configured to reject unencrypted connections such checks will not succeed.

Compiling Zabbix with encryption support To support encryption Zabbix must be compiled and linked with one of the supported crypto libraries:

- GnuTLS - from version 3.1.18
- OpenSSL - versions 1.0.1, 1.0.2, 1.1.0, 1.1.1, 3.0.x
- LibreSSL - tested with versions 2.7.4, 2.8.2:
 - LibreSSL 2.6.x is not supported
 - LibreSSL is supported as a compatible replacement of OpenSSL; the new `tls_*`() LibreSSL-specific API functions are not used. Zabbix components compiled with LibreSSL will not be able to use PSK, only certificates can be used.

Note:

You can find out more about setting up SSL for Zabbix frontend by referring to these [best practices](#).

The library is selected by specifying the respective option to "configure" script:

- `--with-gnutls [=DIR]`
- `--with-openssl [=DIR]` (also used for LibreSSL)

For example, to configure the sources for server and agent with *OpenSSL* you may use something like:

```
./configure --enable-server --enable-agent --with-mysql --enable-ipv6 --with-net-snmp --with-libcurl --wit
```

Different Zabbix components may be compiled with different crypto libraries (e.g. a server with *OpenSSL*, an agent with *GnuTLS*).

Attention:
 If you plan to use pre-shared keys (PSK), consider using *GnuTLS* or *OpenSSL 1.1.0* (or newer) libraries in Zabbix components using PSKs. *GnuTLS* and *OpenSSL 1.1.0* libraries support PSK ciphersuites with [Perfect Forward Secrecy](#). Older versions of the *OpenSSL* library (1.0.1, 1.0.2c) also support PSKs, but available PSK ciphersuites do not provide Perfect Forward Secrecy.

Connection encryption management Connections in Zabbix can use:

- no encryption (default)
- **RSA certificate-based encryption**
- **PSK-based encryption**

There are two important parameters used to specify encryption between Zabbix components:

- **TLSCConnect** - specifies what encryption to use for outgoing connections (unencrypted, PSK or certificate)
- **TLSAccept** - specifies what types of connections are allowed for incoming connections (unencrypted, PSK or certificate). One or more values can be specified.

TLSCConnect is used in the configuration files for Zabbix proxy (in active mode, specifies only connections to server) and Zabbix agent (for active checks). In Zabbix frontend the **TLSCConnect** equivalent is the *Connections to host* field in *Data collection* → *Hosts* → <some host> → *Encryption* tab and the *Connections to proxy* field in *Administration* → *Proxies* → <some proxy> → *Encryption* tab. If the configured encryption type for connection fails, no other encryption types will be tried.

TLSAccept is used in the configuration files for Zabbix proxy (in passive mode, specifies only connections from server) and Zabbix agent (for passive checks). In Zabbix frontend the **TLSAccept** equivalent is the *Connections from host* field in *Data collection* → *Hosts* → <some host> → *Encryption* tab and the *Connections from proxy* field in *Administration* → *Proxies* → <some proxy> → *Encryption* tab.

Normally you configure only one type of encryption for incoming connections. But you may want to switch the encryption type, e.g. from unencrypted to certificate-based with minimum downtime and rollback possibility. To achieve this:

- Set **TLSAccept=unencrypted, cert** in the agent configuration file and restart Zabbix agent
- Test connection with `zabbix_get` to the agent using certificate. If it works, you can reconfigure encryption for that agent in Zabbix frontend in the *Data collection* → *Hosts* → <some host> → *Encryption* tab by setting *Connections to host* to "Certificate".
- When server configuration cache gets updated (and proxy configuration is updated if the host is monitored by proxy) then connections to that agent will be encrypted
- If everything works as expected you can set **TLSAccept=cert** in the agent configuration file and restart Zabbix agent. Now the agent will be accepting only encrypted certificate-based connections. Unencrypted and PSK-based connections will be rejected.

In a similar way it works on server and proxy. If in Zabbix frontend in host configuration *Connections from host* is set to "Certificate" then only certificate-based encrypted connections will be accepted from the agent (active checks) and `zabbix_sender` (trapper items).

Most likely you will configure incoming and outgoing connections to use the same encryption type or no encryption at all. But technically it is possible to configure it asymmetrically, e.g. certificate-based encryption for incoming and PSK-based for outgoing connections.

Encryption configuration for each host is displayed in the Zabbix frontend, in *Data collection* → *Hosts* in the *Agent encryption* column. For example:

Example	Connections to host	Allowed connections from host	Rejected connections from host
	Unencrypted	Unencrypted	Encrypted, certificate and PSK-based encrypted
	Encrypted, certificate-based	Encrypted, certificate-based	Unencrypted and PSK-based encrypted
	Encrypted, PSK-based	Encrypted, PSK-based	Unencrypted and certificate-based encrypted
	Encrypted, PSK-based	Unencrypted and PSK-based encrypted	Certificate-based encrypted
	Encrypted, certificate-based	Unencrypted, PSK or certificate-based encrypted	-

Attention:

Connections are unencrypted by default. Encryption must be configured for each host and proxy individually.

zabbix_get and zabbix_sender with encryption See [zabbix_get](#) and [zabbix_sender](#) manpages for using them with encryption.

Ciphersuites Ciphersuites by default are configured internally during Zabbix startup.

Also user-configured ciphersuites are supported for GnuTLS and OpenSSL. Users may **configure** ciphersuites according to their security policies. Using this feature is optional (built-in default ciphersuites still work).

For crypto libraries compiled with default settings Zabbix built-in rules typically result in the following ciphersuites (in order from higher to lower priority):

Library	Certificate ciphersuites	PSK ciphersuites
<i>GnuTLS 3.1.18</i>	TLS_ECDHE_RSA_AES_128_GCM_SHA256	TLS_ECDHE_PSK_AES_128_CBC_SHA256
	TLS_ECDHE_RSA_AES_128_CBC_SHA256	TLS_ECDHE_PSK_AES_128_CBC_SHA1
	TLS_ECDHE_RSA_AES_128_CBC_SHA1	TLS_PSK_AES_128_GCM_SHA256
	TLS_RSA_AES_128_GCM_SHA256	TLS_PSK_AES_128_CBC_SHA256
	TLS_RSA_AES_128_CBC_SHA256	TLS_PSK_AES_128_CBC_SHA1
	TLS_RSA_AES_128_CBC_SHA1	
<i>OpenSSL 1.0.2c</i>	ECDHE-RSA-AES128-GCM-SHA256	PSK-AES128-CBC-SHA
	ECDHE-RSA-AES128-SHA256	
	ECDHE-RSA-AES128-SHA	
	AES128-GCM-SHA256	
	AES128-SHA256	
<i>OpenSSL 1.1.0</i>	AES128-SHA	
	ECDHE-RSA-AES128-GCM-SHA256	ECDHE-PSK-AES128-CBC-SHA256
	ECDHE-RSA-AES128-SHA256	ECDHE-PSK-AES128-CBC-SHA
	ECDHE-RSA-AES128-SHA	PSK-AES128-GCM-SHA256
	AES128-GCM-SHA256	PSK-AES128-CCM8
	AES128-CCM8	PSK-AES128-CCM
	AES128-CCM	PSK-AES128-CBC-SHA256
AES128-SHA256	PSK-AES128-CBC-SHA	
<i>OpenSSL 1.1.1d</i>	AES128-SHA	
	TLS_AES_256_GCM_SHA384	TLS_CHACHA20_POLY1305_SHA256
	TLS_CHACHA20_POLY1305_SHA256	TLS_AES_128_GCM_SHA256
	TLS_AES_128_GCM_SHA256	ECDHE-PSK-AES128-CBC-SHA256
	ECDHE-RSA-AES128-GCM-SHA256	ECDHE-PSK-AES128-CBC-SHA
	ECDHE-RSA-AES128-SHA256	PSK-AES128-GCM-SHA256
	ECDHE-RSA-AES128-SHA	PSK-AES128-CCM8
	AES128-GCM-SHA256	PSK-AES128-CCM
	AES128-CCM8	PSK-AES128-CBC-SHA256
	AES128-CCM	PSK-AES128-CBC-SHA
AES128-SHA256		
AES128-SHA		

User-configured ciphersuites The built-in ciphersuite selection criteria can be overridden with user-configured ciphersuites.

Attention:

User-configured ciphersuites is a feature intended for advanced users who understand TLS ciphersuites, their security and consequences of mistakes, and who are comfortable with TLS troubleshooting.

The built-in ciphersuite selection criteria can be overridden using the following parameters:

Override scope	Parameter	Value	Description
Ciphersuite selection for certificates	TLSCipherCert13	Valid OpenSSL 1.1.1 cipher strings for TLS 1.3 protocol (their values are passed to the OpenSSL function <code>SSL_CTX_set_ciphersuites()</code>).	Certificate-based ciphersuite selection criteria for TLS 1.3 Only OpenSSL 1.1.1 or newer.
	TLSCipherCert	Valid OpenSSL cipher strings for TLS 1.2 or valid GnuTLS priority strings . Their values are passed to the <code>SSL_CTX_set_cipher_list()</code> or <code>gnutls_priority_init()</code> functions, respectively.	Certificate-based ciphersuite selection criteria for TLS 1.2/1.3 (GnuTLS), TLS 1.2 (OpenSSL)
Ciphersuite selection for PSK	TLSCipherPSK13	Valid OpenSSL 1.1.1 cipher strings for TLS 1.3 protocol (their values are passed to the OpenSSL function <code>SSL_CTX_set_ciphersuites()</code>).	PSK-based ciphersuite selection criteria for TLS 1.3 Only OpenSSL 1.1.1 or newer.
	TLSCipherPSK	Valid OpenSSL cipher strings for TLS 1.2 or valid GnuTLS priority strings . Their values are passed to the <code>SSL_CTX_set_cipher_list()</code> or <code>gnutls_priority_init()</code> functions, respectively.	PSK-based ciphersuite selection criteria for TLS 1.2/1.3 (GnuTLS), TLS 1.2 (OpenSSL)
Combined ciphersuite list for certificate and PSK	TLSCipherAll13	Valid OpenSSL 1.1.1 cipher strings for TLS 1.3 protocol (their values are passed to the OpenSSL function <code>SSL_CTX_set_ciphersuites()</code>).	Ciphersuite selection criteria for TLS 1.3 Only OpenSSL 1.1.1 or newer.
	TLSCipherAll	Valid OpenSSL cipher strings for TLS 1.2 or valid GnuTLS priority strings . Their values are passed to the <code>SSL_CTX_set_cipher_list()</code> or <code>gnutls_priority_init()</code> functions, respectively.	Ciphersuite selection criteria for TLS 1.2/1.3 (GnuTLS), TLS 1.2 (OpenSSL)

To override the ciphersuite selection in `zabbix_get` and `zabbix_sender` utilities - use the command-line parameters:

- `--tls-cipher13`
- `--tls-cipher`

The new parameters are optional. If a parameter is not specified, the internal default value is used. If a parameter is defined it cannot be empty.

If the setting of a `TLSCipher*` value in the crypto library fails then the server, proxy or agent will not start and an error is logged.

It is important to understand when each parameter is applicable.

Outgoing connections

The simplest case is outgoing connections:

- For outgoing connections with certificate - use `TLSCipherCert13` or `TLSCipherCert`
- For outgoing connections with PSK - use `TLSCipherPSK13` or `TLSCipherPSK`
- In case of `zabbix_get` and `zabbix_sender` utilities the command-line parameters `--tls-cipher13` or `--tls-cipher` can be used (encryption is unambiguously specified with a `--tls-connect` parameter)

Incoming connections

It is a bit more complicated with incoming connections because rules are specific for components and configuration.

For Zabbix **agent**:

Agent connection setup	Cipher configuration
<code>TLSCConnect=cert</code>	<code>TLSCipherCert, TLSCipherCert13</code>
<code>TLSCConnect=psk</code>	<code>TLSCipherPSK, TLSCipherPSK13</code>
<code>TLSAccept=cert</code>	<code>TLSCipherCert, TLSCipherCert13</code>
<code>TLSAccept=psk</code>	<code>TLSCipherPSK, TLSCipherPSK13</code>

Agent connection setup	Cipher configuration
TLSAccept=cert,psk	TLSCipherAll, TLSCipherAll13

For Zabbix **server** and **proxy**:

Connection setup	Cipher configuration
Outgoing connections using PSK	TLSCipherPSK, TLSCipherPSK13
Incoming connections using certificates	TLSCipherAll, TLSCipherAll13
Incoming connections using PSK if server has no certificate	TLSCipherPSK, TLSCipherPSK13
Incoming connections using PSK if server has certificate	TLSCipherAll, TLSCipherAll13

Some pattern can be seen in the two tables above:

- TLSCipherAll and TLSCipherAll13 can be specified only if a combined list of certificate- **and** PSK-based ciphersuites is used. There are two cases when it takes place: server (proxy) with a configured certificate (PSK ciphersuites are always configured on server, proxy if crypto library supports PSK), agent configured to accept both certificate- and PSK-based incoming connections
- in other cases TLSCipherCert* and/or TLSCipherPSK* are sufficient

The following tables show the TLSCipher* built-in default values. They could be a good starting point for your own custom values.

Parameter	GnuTLS 3.6.12
TLSCipherCert	NONE:+VERS-TLS1.2:+ECDHE-RSA:+RSA:+AES-128-GCM:+AES-128-CBC:+AEAD:+SHA256:+SHA1:+CURVE-ALL:+COMP-NULL:+SIGN-ALL:+CTYPE-X.509
TLSCipherPSK	NONE:+VERS-TLS1.2:+ECDHE-PSK:+PSK:+AES-128-GCM:+AES-128-CBC:+AEAD:+SHA256:+SHA1:+CURVE-ALL:+COMP-NULL:+SIGN-ALL
TLSCipherAll	NONE:+VERS-TLS1.2:+ECDHE-RSA:+RSA:+ECDHE-PSK:+PSK:+AES-128-GCM:+AES-128-CBC:+AEAD:+SHA256:+SHA1:+CURVE-ALL:+COMP-NULL:+SIGN-ALL:+CTYPE-X.509

Parameter	OpenSSL 1.1.1d ¹
TLSCipherCert13	
TLSCipherCert	EECDH+aRSA+AES128:RSA+aRSA+AES128
TLSCipherPSK13	TLS_CHACHA20_POLY1305_SHA256:TLS_AES_128_GCM_SHA256
TLSCipherPSK	kECDHEPSK+AES128:kPSK+AES128
TLSCipherAll13	
TLSCipherAll	EECDH+aRSA+AES128:RSA+aRSA+AES128:kECDHEPSK+AES128:kPSK+AES128

¹ Default values are different for older OpenSSL versions (1.0.1, 1.0.2, 1.1.0), for LibreSSL and if OpenSSL is compiled without PSK support.

Examples of user-configured ciphersuites

See below the following examples of user-configured ciphersuites:

- [Testing cipher strings and allowing only PFS ciphersuites](#)
- [Switching from AES128 to AES256](#)

Testing cipher strings and allowing only PFS ciphersuites

To see which ciphersuites have been selected you need to set 'DebugLevel=4' in the configuration file, or use the -vv option for zabbix_sender.

Some experimenting with TLSCipher* parameters might be necessary before you get the desired ciphersuites. It is inconvenient to restart Zabbix server, proxy or agent multiple times just to tweak TLSCipher* parameters. More convenient options are using zabbix_sender or the openssl command. Let's show both.

1. Using zabbix_sender.

Let's make a test configuration file, for example /home/zabbix/test.conf, with the syntax of a zabbix_agentd.conf file:

```
Hostname=nonexisting
ServerActive=nonexisting
```

```
TLSCipherCert=cert
TLSCAFile=/home/zabbix/ca.crt
TLSCertFile=/home/zabbix/agent.crt
TLSCipherKeyFile=/home/zabbix/agent.key
TLSPSKIdentity=nonexisting
TLSPSKFile=/home/zabbix/agent.psk
```

You need valid CA and agent certificates and PSK for this example. Adjust certificate and PSK file paths and names for your environment.

If you are not using certificates, but only PSK, you can make a simpler test file:

```
Hostname=nonexisting
ServerActive=nonexisting
```

```
TLSCipherConnect=psk
TLSPSKIdentity=nonexisting
TLSPSKFile=/home/zabbix/agentd.psk
```

The selected ciphersuites can be seen by running `zabbix_sender` (example compiled with OpenSSL 1.1.d):

```
$ zabbix_sender -vv -c /home/zabbix/test.conf -k nonexisting_item -o 1 2>&1 | grep ciphersuites
zabbix_sender [41271]: DEBUG: zbx_tls_init_child() certificate ciphersuites: TLS_AES_256_GCM_SHA384 TLS_
zabbix_sender [41271]: DEBUG: zbx_tls_init_child() PSK ciphersuites: TLS_CHACHA20_POLY1305_SHA256 TLS_
zabbix_sender [41271]: DEBUG: zbx_tls_init_child() certificate and PSK ciphersuites: TLS_AES_256_GCM_SHA
```

Here you see the ciphersuites selected by default. These default values are chosen to ensure interoperability with Zabbix agents running on systems with older OpenSSL versions (from 1.0.1).

With newer systems you can choose to tighten security by allowing only a few ciphersuites, e.g. only ciphersuites with PFS (Perfect Forward Secrecy). Let's try to allow only ciphersuites with PFS using `TLSCipher*` parameters.

Attention:

The result will not be interoperable with systems using OpenSSL 1.0.1 and 1.0.2, if PSK is used. Certificate-based encryption should work.

Add two lines to the `test.conf` configuration file:

```
TLSCipherCert=EECDH+aRSA+AES128
TLSCipherPSK=kECDHEPSK+AES128
```

and test again:

```
$ zabbix_sender -vv -c /home/zabbix/test.conf -k nonexisting_item -o 1 2>&1 | grep ciphersuites
zabbix_sender [42892]: DEBUG: zbx_tls_init_child() certificate ciphersuites: TLS_AES_256_GCM_SHA384 TLS_
zabbix_sender [42892]: DEBUG: zbx_tls_init_child() PSK ciphersuites: TLS_CHACHA20_POLY1305_SHA256 TLS_
zabbix_sender [42892]: DEBUG: zbx_tls_init_child() certificate and PSK ciphersuites: TLS_AES_256_GCM_SHA
```

The "certificate ciphersuites" and "PSK ciphersuites" lists have changed - they are shorter than before, only containing TLS 1.3 ciphersuites and TLS 1.2 ECDHE-* ciphersuites as expected.

2. `TLSCipherAll` and `TLSCipherAll13` cannot be tested with `zabbix_sender`; they do not affect "certificate and PSK ciphersuites" value shown in the example above. To tweak `TLSCipherAll` and `TLSCipherAll13` you need to experiment with the agent, proxy or server.

So, to allow only PFS ciphersuites you may need to add up to three parameters

```
TLSCipherCert=EECDH+aRSA+AES128
TLSCipherPSK=kECDHEPSK+AES128
TLSCipherAll=EECDH+aRSA+AES128:kECDHEPSK+AES128
```

to `zabbix_agentd.conf`, `zabbix_proxy.conf` and `zabbix_server.conf` if each of them has a configured certificate and agent has also PSK.

If your Zabbix environment uses only PSK-based encryption and no certificates, then only one:

```
TLSCipherPSK=kECDHEPSK+AES128
```

Now that you understand how it works you can test the ciphersuite selection even outside of Zabbix, with the `openssl` command. Let's test all three `TLSCipher*` parameter values:

```
$ openssl ciphers ECDH+aRSA+AES128 | sed 's:// /g'
TLS_AES_256_GCM_SHA384 TLS_CHACHA20_POLY1305_SHA256 TLS_AES_128_GCM_SHA256 ECDHE-RSA-AES128-GCM-SHA256 E
$ openssl ciphers kECDHEPSK+AES128 | sed 's:// /g'
TLS_AES_256_GCM_SHA384 TLS_CHACHA20_POLY1305_SHA256 TLS_AES_128_GCM_SHA256 ECDHE-PSK-AES128-CBC-SHA256 E
$ openssl ciphers ECDH+aRSA+AES128:kECDHEPSK+AES128 | sed 's:// /g'
TLS_AES_256_GCM_SHA384 TLS_CHACHA20_POLY1305_SHA256 TLS_AES_128_GCM_SHA256 ECDHE-RSA-AES128-GCM-SHA256 E
```

You may prefer `openssl ciphers` with option `-V` for a more verbose output:

```
$ openssl ciphers -V ECDH+aRSA+AES128:kECDHEPSK+AES128
0x13,0x02 - TLS_AES_256_GCM_SHA384 TLSv1.3 Kx=any Au=any Enc=AESECM(256) Mac=AEAD
0x13,0x03 - TLS_CHACHA20_POLY1305_SHA256 TLSv1.3 Kx=any Au=any Enc=CHACHA20/POLY1305(256) Mac=AEAD
0x13,0x01 - TLS_AES_128_GCM_SHA256 TLSv1.3 Kx=any Au=any Enc=AESECM(128) Mac=AEAD
0xC0,0x2F - ECDHE-RSA-AES128-GCM-SHA256 TLSv1.2 Kx=ECDH Au=RSA Enc=AESECM(128) Mac=AEAD
0xC0,0x27 - ECDHE-RSA-AES128-SHA256 TLSv1.2 Kx=ECDH Au=RSA Enc=AES(128) Mac=SHA256
0xC0,0x13 - ECDHE-RSA-AES128-SHA TLSv1 Kx=ECDH Au=RSA Enc=AES(128) Mac=SHA1
0xC0,0x37 - ECDHE-PSK-AES128-CBC-SHA256 TLSv1 Kx=ECDHEPSK Au=PSK Enc=AES(128) Mac=SHA256
0xC0,0x35 - ECDHE-PSK-AES128-CBC-SHA TLSv1 Kx=ECDHEPSK Au=PSK Enc=AES(128) Mac=SHA1
```

Similarly, you can test the priority strings for GnuTLS:

```
$ gnutls-cli -l --priority=NONE:+VERS-TLS1.2:+ECDHE-RSA:+AES-128-GCM:+AES-128-CBC:+AEAD:+SHA256:+CURVE-ALL:+COMP-ALL
Cipher suites for NONE:+VERS-TLS1.2:+ECDHE-RSA:+AES-128-GCM:+AES-128-CBC:+AEAD:+SHA256:+CURVE-ALL:+COMP-ALL
TLS_ECDHE_RSA_AES_128_GCM_SHA256 0xc0, 0x2f TLS1.2
TLS_ECDHE_RSA_AES_128_CBC_SHA256 0xc0, 0x27 TLS1.2
```

```
Protocols: VERS-TLS1.2
Ciphers: AES-128-GCM, AES-128-CBC
MACs: AEAD, SHA256
Key Exchange Algorithms: ECDHE-RSA
Groups: GROUP-SECP256R1, GROUP-SECP384R1, GROUP-SECP521R1, GROUP-X25519, GROUP-X448, GROUP-FFDHE2048, GROUP-FFDHE3072
PK-signatures: SIGN-RSA-SHA256, SIGN-RSA-PSS-SHA256, SIGN-RSA-PSS-RSAE-SHA256, SIGN-ECDSA-SHA256, SIGN-ECDSA-SHA384, SIGN-ECDSA-SHA512
```

Switching from AES128 to AES256

Zabbix uses AES128 as the built-in default for data. Let's assume you are using certificates and want to switch to AES256, on OpenSSL 1.1.1.

This can be achieved by adding the respective parameters in `zabbix_server.conf`:

```
TLSCAFile=/home/zabbix/ca.crt
TLSCertFile=/home/zabbix/server.crt
TLSKeyFile=/home/zabbix/server.key
TLSCipherCert13=TLS_AES_256_GCM_SHA384
TLSCipherCert=EECDH+aRSA+AES256:-SHA1:-SHA384
TLSCipherPSK13=TLS_CHACHA20_POLY1305_SHA256
TLSCipherPSK=kECDHEPSK+AES256:-SHA1
TLSCipherAll13=TLS_AES_256_GCM_SHA384
TLSCipherAll=EECDH+aRSA+AES256:-SHA1:-SHA384
```

Attention:

Although only certificate-related ciphersuites will be used, `TLSCipherPSK*` parameters are defined as well to avoid their default values which include less secure ciphers for wider interoperability. PSK ciphersuites cannot be completely disabled on server/proxy.

And in `zabbix_agentd.conf`:

```
TLSConnect=cert
TLSAccept=cert
TLSCAFile=/home/zabbix/ca.crt
TLSCertFile=/home/zabbix/agent.crt
TLSKeyFile=/home/zabbix/agent.key
TLSCipherCert13=TLS_AES_256_GCM_SHA384
TLSCipherCert=EECDH+aRSA+AES256:-SHA1:-SHA384
```

1 Using certificates

Overview

Zabbix can use RSA certificates in PEM format, signed by a public or an in-house certificate authority (CA).

Certificate verification is performed against a pre-configured CA certificate. Optionally, [Certificate Revocation Lists \(CRL\)](#) can be used.

Each Zabbix component can have only one certificate configured.

For more information on setting up and operating an internal CA, generating and signing certificate requests, and revoking certificates, refer to tutorials such as the [OpenSSL PKI Tutorial v2.0](#).

Carefully consider and test your certificate extensions. For more details, see [Limitations on using X.509 v3 certificate extensions](#).

Certificate configuration parameters

The following configuration parameters are supported for setting up certificates on Zabbix components.

Parameter	Mandatory	Description
<i>TLSCAFile</i>	yes	Full pathname of a file containing the top-level CA(s) certificates for peer certificate verification. If using a certificate chain with multiple members, order the certificates with lower level CA(s) certificates first, followed by higher level CA(s) certificates. Certificates from multiple CAs can be included in a single file.
<i>TLSCRLFile</i>	no	Full pathname of a file containing Certificate Revocation Lists (CRL) .
<i>TLSCertFile</i>	yes	Full pathname of a file containing the certificate. If using a certificate chain with multiple members, order the certificates with the server, proxy, or agent certificate first, followed by lower level CA(s) certificates, and concluded by higher level CA(s) certificates.
<i>TLSKeyFile</i>	yes	Full pathname of a file containing the private key. Ensure that this file is readable only by the Zabbix user by setting appropriate access rights.
<i>TLSServerCertIssuer</i>	no	Allowed server certificate issuer.
<i>TLSServerCertSubject</i>	no	Allowed server certificate subject.

Configuration examples

After setting up the necessary certificates, configure Zabbix components to use certificate-based encryption.

Below are detailed steps for configuring:

- [Zabbix server](#)
- [Zabbix proxy](#)
- [Zabbix agent](#)

Zabbix server

1. Prepare the CA certificate file.

In order to verify peer certificates, Zabbix server must have access to the file containing the top-level, self-signed root CA certificates. For example, if certificates from two independent root CAs are needed, place them into a file at `/home/zabbix/zabbix_ca_file.crt`

Certificate:

```
Data:
  Version: 3 (0x2)
  Serial Number: 1 (0x1)
Signature Algorithm: sha1WithRSAEncryption
  Issuer: DC=com, DC=zabbix, O=Zabbix SIA, OU=Development group, CN=Root1 CA
  ...
  Subject: DC=com, DC=zabbix, O=Zabbix SIA, OU=Development group, CN=Root1 CA
  Subject Public Key Info:
    Public Key Algorithm: rsaEncryption
    Public-Key: (2048 bit)
    ...
  X509v3 extensions:
```

```

X509v3 Key Usage: critical
Certificate Sign, CRL Sign
X509v3 Basic Constraints: critical
CA:TRUE
...
-----BEGIN CERTIFICATE-----
MIID2jCCAsKgAwIBAgIBATANBgkqhkiG9w0BAQUFADB+MRMwEQYKCZImiZPyLGGQ
....
9wEzdN8uTrqoyU78gi12npLj08LegRKjb5hFTVm0
-----END CERTIFICATE-----
Certificate:
Data:
Version: 3 (0x2)
Serial Number: 1 (0x1)
Signature Algorithm: sha1WithRSAEncryption
Issuer: DC=com, DC=zabbix, O=Zabbix SIA, OU=Development group, CN=Root2 CA
...
Subject: DC=com, DC=zabbix, O=Zabbix SIA, OU=Development group, CN=Root2 CA
Subject Public Key Info:
Public Key Algorithm: rsaEncryption
Public-Key: (2048 bit)
....
X509v3 extensions:
X509v3 Key Usage: critical
Certificate Sign, CRL Sign
X509v3 Basic Constraints: critical
CA:TRUE
....
-----BEGIN CERTIFICATE-----
MIID3DCCAsSgAwIBAgIBATANBgkqhkiG9w0BAQUFADB/MRMwEQYKCZImiZPyLGGQ
...
vdGNYoSfvu41GQAR5Vj5FnRJRzv5XQOZ3B6894GY1zY=
-----END CERTIFICATE-----

```

2. Place the Zabbix server certificate/certificate chain into a file, for example, at /home/zabbix/zabbix_server.crt. The first certificate is the Zabbix server certificate, followed by the intermediate CA certificate:

```

Certificate:
Data:
Version: 3 (0x2)
Serial Number: 1 (0x1)
Signature Algorithm: sha1WithRSAEncryption
Issuer: DC=com, DC=zabbix, O=Zabbix SIA, OU=Development group, CN=Signing CA
...
Subject: DC=com, DC=zabbix, O=Zabbix SIA, OU=Development group, CN=Zabbix server
Subject Public Key Info:
Public Key Algorithm: rsaEncryption
Public-Key: (2048 bit)
...
X509v3 extensions:
X509v3 Key Usage: critical
Digital Signature, Key Encipherment
X509v3 Basic Constraints:
CA:FALSE
...
-----BEGIN CERTIFICATE-----
MIIECDCCAvCgAwIBAgIBATANBgkqhkiG9w0BAQUFADCBgTETMBEGCgmSJomT8ixk
...
h02u1GHiy46GI+xfR3LsPwFKlkTaaLaL/6aaoQ==
-----END CERTIFICATE-----
Certificate:
Data:
Version: 3 (0x2)

```

```

Serial Number: 2 (0x2)
Signature Algorithm: sha1WithRSAEncryption
Issuer: DC=com, DC=zabbix, O=Zabbix SIA, OU=Development group, CN=Root1 CA
...
Subject: DC=com, DC=zabbix, O=Zabbix SIA, OU=Development group, CN=Signing CA
Subject Public Key Info:
    Public Key Algorithm: rsaEncryption
    Public-Key: (2048 bit)
...
X509v3 extensions:
    X509v3 Key Usage: critical
        Certificate Sign, CRL Sign
    X509v3 Basic Constraints: critical
        CA:TRUE, pathlen:0
...
-----BEGIN CERTIFICATE-----
MIID4TCCAsmgAwIBAgIBAjANBgkqhkiG9w0BAQUFAADB+MRMwEQYKCZImiZPyLGGQB
...
dyCeWnvL7u5sd6ffo8iRnyOQzbHKmQt/wUtcVIvWXdMIFJMOHw==
-----END CERTIFICATE-----

```

Note:

Use only the attributes mentioned above for both client and server certificates to avoid affecting the certificate verification process. For example, OpenSSL might fail to establish an encrypted connection if *X509v3 Subject Alternative Name* or *Netscape Cert Type* extensions are used. For more information, see [Limitations on using X.509 v3 certificate extensions](#).

3. Place the Zabbix server private key into a file, for example, at `/home/zabbix/zabbix_server.key`:

```

-----BEGIN PRIVATE KEY-----
MIIEwAIBADANBgkqhkiG9w0BAQEFAASCBKowggSmAgEAAoIBAQC9tIXIJoVnNXDl
...
IJLkhbybBYEf47MLhffWa7XvZTY=
-----END PRIVATE KEY-----

```

4. Edit the TLS configuration parameters in the [Zabbix server configuration file](#):

```

TLSCAFile=/home/zabbix/zabbix_ca_file
TLSCertFile=/home/zabbix/zabbix_server.crt
TLSKeyFile=/home/zabbix/zabbix_server.key

```

Zabbix proxy

1. Prepare files with the top-level CA certificates, the Zabbix proxy certificate/certificate chain, and the private key as described in the [Zabbix server](#) section. Then, edit the `TLSCAFile`, `TLSCertFile`, and `TLSKeyFile` parameters in the [Zabbix proxy configuration file](#) accordingly.

2. Edit additional TLS parameters in the [Zabbix proxy configuration file](#):

- For active proxy: `TLSConnect=cert`
- For passive proxy: `TLSAccept=cert`

Note:

To improve proxy security, you can also set the `TLSServerCertIssuer` and `TLSServerCertSubject` parameters. For more information, see [Restricting allowed certificate issuer and subject](#).

TLS parameters in the final proxy configuration file may look as follows:

```

TLSConnect=cert
TLSAccept=cert
TLSCAFile=/home/zabbix/zabbix_ca_file
TLSServerCertIssuer=CN=Signing CA,OU=Development group,O=Zabbix SIA,DC=zabbix,DC=com
TLSServerCertSubject=CN=Zabbix server,OU=Development group,O=Zabbix SIA,DC=zabbix,DC=com
TLSCertFile=/home/zabbix/zabbix_proxy.crt
TLSKeyFile=/home/zabbix/zabbix_proxy.key

```

3. Configure encryption for this proxy in Zabbix frontend:

- Go to: *Administration* → *Proxies*.
- Select the proxy and click the *Encryption* tab.

In the examples below, the *Issuer* and *Subject* fields are filled in. For more information on why and how to use these fields, see [Restricting allowed certificate issuer and subject](#).

For active proxy:

The screenshot shows the 'Proxy' configuration window with the 'Encryption' tab active. Under 'Connections to proxy', the 'Certificate' button is highlighted. Under 'Connections from proxy', the 'Certificate' checkbox is checked. The 'Issuer' field contains 'CN=Signing CA,OU=Development group,O=Zabbix SIA,DC=zabbix,DC=com' and the 'Subject' field contains 'CN=www01,OU=Development group,O=Zabbix SIA,DC=zabbix,DC=com'. At the bottom, there are buttons for 'Update', 'Refresh configuration', 'Clone', 'Delete', and 'Cancel'.

For passive proxy:

The screenshot shows the 'Proxy' configuration window with the 'Encryption' tab active. Under 'Connections to proxy', the 'Certificate' button is highlighted. Under 'Connections from proxy', the 'No encryption' checkbox is checked. The 'Issuer' field contains 'CN=Signing CA,OU=Development group,O=Zabbix SIA,DC=zabbix,DC=com' and the 'Subject' field contains 'CN=www01,OU=Development group,O=Zabbix SIA,DC=zabbix,DC=com'. At the bottom, there are buttons for 'Update', 'Refresh configuration', 'Clone', 'Delete', and 'Cancel'.

Zabbix agent

1. Prepare files with the top-level CA certificates, the Zabbix agent certificate/certificate chain, and the private key as described in the [Zabbix server](#) section. Then, edit the `TLSCAFile`, `TLSCertFile`, and `TLSKeyFile` parameters in the [Zabbix agent configuration file](#) accordingly.
2. Edit additional TLS parameters in the [Zabbix agent configuration file](#):
 - For active agent: `TLSConnect=cert`
 - For passive agent: `TLSAccept=cert`

Note:

To improve agent security, you can set the `TLSServerCertIssuer` and `TLSServerCertSubject` parameters. For more information, see [Restricting allowed certificate issuer and subject](#).

The TLS parameters in the final agent configuration file may look as follows. Note that the example assumes that the host is monitored by a proxy, hence it is specified as the certificate Subject:

```

TLSCConnect=cert
TLSAccept=cert
TLSCAFile=/home/zabbix/zabbix_ca_file

```

```
TLSServerCertIssuer=CN=Signing CA,OU=Development group,O=Zabbix SIA,DC=zabbix,DC=com
TLSServerCertSubject=CN=Zabbix proxy,OU=Development group,O=Zabbix SIA,DC=zabbix,DC=com
TLSCertFile=/home/zabbix/zabbix_agentd.crt
TLSKeyFile=/home/zabbix/zabbix_agentd.key
```

3. Configure encryption in Zabbix frontend for the host monitored by this agent.

- Go to: *Data collection* → *Hosts*.
- Select the host and click the *Encryption* tab.

In the example below, the *Issuer* and *Subject* fields are filled in. For more information on why and how to use these fields, see [Restricting allowed certificate issuer and subject](#).

The screenshot shows the 'Host' configuration window in Zabbix, specifically the 'Encryption' tab. It features several sections for configuring connections:

- Connections to host:** Three buttons are present: 'No encryption', 'PSK', and 'Certificate'. The 'Certificate' button is highlighted.
- Connections from host:** Three radio buttons are present: 'No encryption', 'PSK', and 'Certificate'. The 'Certificate' radio button is selected.
- Issuer:** A text input field containing the value 'CN=Signing CA,OU=Development group,O=Zabbix SIA,DC=zabbix,DC=com'.
- Subject:** A text input field containing the value 'CN=www01,OU=Development group,O=Zabbix SIA,DC=zabbix,DC=com'.

At the bottom right, there are four buttons: 'Update', 'Clone', 'Delete', and 'Cancel'.

Zabbix web service

1. Prepare files with the top-level CA certificates, the Zabbix web service certificate/certificate chain, and the private key as described in the [Zabbix server](#) section. Then, edit the `TLSCAFile`, `TLSCertFile`, and `TLSKeyFile` parameters in the [Zabbix web service configuration file](#) accordingly.
2. Edit an additional TLS parameter in the [Zabbix web service configuration file](#): `TLSAccept=cert`

TLS parameters in the final web service configuration file may look as follows:

```
TLSAccept=cert
TLSCAFile=/home/zabbix/zabbix_ca_file
TLSCertFile=/home/zabbix/zabbix_web_service.crt
TLSKeyFile=/home/zabbix/zabbix_web_service.key
```

3. Configure Zabbix server to connect to the TLS-configured Zabbix web service by editing the `WebServiceURL` parameter in the [Zabbix server configuration file](#):

```
WebServiceURL=https://example.com
```

Restricting allowed certificate issuer and subject

When two Zabbix components (for example, server and agent) establish a TLS connection, they validate each other's certificates. If a peer certificate is signed by a trusted CA (with a pre-configured top-level certificate in `TLSCAFile`), is valid, has not expired, and passes other checks, then the communication between components can proceed. In this simplest case, the certificate issuer and subject are not verified.

However, this presents a risk: anyone with a valid certificate can impersonate anyone else (for example, a host certificate could be used to impersonate a server). While this may be acceptable in small environments where certificates are signed by a dedicated in-house CA and the risk of impersonation is low, it may not be sufficient in larger or more security-sensitive environments.

If your top-level CA issues certificates that should not be accepted by Zabbix or if you want to reduce the risk of impersonation, you can restrict allowed certificates by specifying their issuer and subject.

For example, in the Zabbix proxy configuration file, you could specify:

```
TLSServerCertIssuer=CN=Signing CA,OU=Development group,O=Zabbix SIA,DC=zabbix,DC=com
TLSServerCertSubject=CN=Zabbix server,OU=Development group,O=Zabbix SIA,DC=zabbix,DC=com
```

With these settings, an active proxy will not communicate with a Zabbix server whose certificate has a different issuer or subject. Similarly, a passive proxy will not accept requests from such a server.

Rules for matching Issuer and Subject strings

The rules for matching Issuer and Subject strings are as follows:

- Issuer and Subject strings are checked independently. Both are optional.
- An unspecified string means that any string is accepted.
- Strings are compared as *is* and must match exactly.
- UTF-8 characters are supported. However, wildcards (*) or regular expressions are not supported.
- The following [RFC 4514](#) requirements are implemented - characters that require escaping (with a '\' backslash, U+005C):
 - anywhere in the string: '"' (U+0022), '+' (U+002B), ',' (U+002C), ';' (U+003B), '<' (U+003C), '>' (U+003E), '\\'
(U+005C);
 - at the beginning of the string: space (' ', U+0020) or number sign ('#', U+0023);
 - at the end of the string: space (' ', U+0020).
- Null characters (U+0000) are not supported. If a null character is encountered, the matching will fail.
- [RFC 4517](#) and [RFC 4518](#) standards are not supported.

For example, if Issuer and Subject organization (O) strings contain trailing spaces and the Subject organizational unit (OU) string contains double quotes, these characters must be escaped:

```
TLSServerCertIssuer=CN=Signing CA,OU=Development head,O=\ Example SIA\ ,DC=example,DC=com
TLSServerCertSubject=CN=Zabbix server,OU=Development group \"5\",O=\ Example SIA\ ,DC=example,DC=com
```

Field order and formatting

Zabbix follows the recommendations of [RFC 4514](#), which specifies a "reverse" order for these fields, starting with the lowest-level fields (CN), proceeding to the mid-level fields (OU, O), and concluding with the highest-level fields (DC).

```
TLSServerCertIssuer=CN=Signing CA,OU=Development group,O=Zabbix SIA,DC=zabbix,DC=com
TLSServerCertSubject=CN=Zabbix proxy,OU=Development group,O=Zabbix SIA,DC=zabbix,DC=com
```

In contrast, OpenSSL by default displays the Issuer and Subject strings in top-level to low-level order. In the following example, Issuer and Subject fields start with the top-level (DC) and end with the low-level (CN) field. The formatting with spaces and field separators also varies based on the options used, and thus will not match the format required by Zabbix.

```
$ openssl x509 -noout -in /home/zabbix/zabbix_proxy.crt -issuer -subject
issuer= /DC=com/DC=zabbix/O=Zabbix SIA/OU=Development group/CN=Signing CA
subject= /DC=com/DC=zabbix/O=Zabbix SIA/OU=Development group/CN=Zabbix proxy

$ openssl x509 -noout -text -in /home/zabbix/zabbix_proxy.crt
Certificate:
    ...
    Issuer: DC=com, DC=zabbix, O=Zabbix SIA, OU=Development group, CN=Signing CA
    ...
    Subject: DC=com, DC=zabbix, O=Zabbix SIA, OU=Development group, CN=Zabbix proxy
```

To format *Issuer* and *Subject* strings correctly for Zabbix, invoke OpenSSL with the following options:

```
$ openssl x509 -noout -issuer -subject \
  -nameopt esc_2253,esc_ctrl,utf8,dump_nostr,dump_unknown,dump_der,sep_comma_plus,dn_rev,sname\
  -in /home/zabbix/zabbix_proxy.crt
```

The output will then be in reverse order, comma-separated, and usable in Zabbix configuration files and frontend:

```
issuer= CN=Signing CA,OU=Development group,O=Zabbix SIA,DC=zabbix,DC=com
subject= CN=Zabbix proxy,OU=Development group,O=Zabbix SIA,DC=zabbix,DC=com
```

Limitations on using X.509 v3 certificate extensions

When implementing X.509 v3 certificates within Zabbix, certain extensions may not be fully supported or could result in inconsistent behavior.

Subject Alternative Name extension

Zabbix does not support the *Subject Alternative Name* extension, which is used to specify alternative DNS names such as IP addresses or email addresses. Zabbix can only validate the value in the *Subject* field of the certificate (see [Restricting Allowed Certificate Issuer and Subject](#)). If certificates include the `subjectAltName` field, the outcome of certificate validation may vary depending on the specific crypto toolkits used to compile Zabbix components. As a result, Zabbix may either accept or reject certificates based on these combinations.

Extended Key Usage extension

Zabbix supports the *Extended Key Usage* extension. However, if used, it is generally required that both *clientAuth* (for TLS WWW client authentication) and *serverAuth* (for TLS WWW server authentication) attributes are specified. For example:

- In passive checks, where Zabbix agent operates as a TLS server, the *serverAuth* attribute must be included in the agent's certificate.
- For active checks, where the agent operates as a TLS client, the *clientAuth* attribute must be included in the agent's certificate.

While GnuTLS may issue a warning for key usage violations, it typically allows communication to proceed despite these warnings.

Name Constraints extension

Support for the *Name Constraints* extension varies among crypto toolkits. Ensure that your chosen toolkit supports this extension. This extension may restrict Zabbix from loading CA certificates if this section is marked as critical, depending on the specific toolkit in use.

Certificate Revocation Lists (CRL)

If a certificate is compromised, the Certificate Authority (CA) can revoke it by including the certificate in a Certificate Revocation List (CRL). CRLs are managed through configuration files and can be specified using the `TLSCRLFile` parameter in server, proxy, and agent configuration files. For example:

```
TLSCRLFile=/home/zabbix/zabbix_crl_file.crt
```

In this case, `zabbix_crl_file.crt` may contain CRLs from multiple CAs, and could look like this:

```
-----BEGIN X509 CRL-----
MIIB/DCB5QIBATANBgkqhkiG9wOBAQUFADCBgTETMBEGCgmSJomT8ixkARkWA2Nv
...
treZeUPjb7LSmZ3K2hpbZN7So0ZcAoHQ3Gwd9npuctg=
-----END X509 CRL-----
-----BEGIN X509 CRL-----
MIIB+TCB4gIBATANBgkqhkiG9wOBAQUFADB/MRMwEQYKCZImiZPyLQGQBGRYDY29t
...
CAEebS2CND3ShBedZ8YSi15906JvaDP611R51Ns=
-----END X509 CRL-----
```

The CRL file is loaded only when Zabbix starts. To update the CRL, restart Zabbix.

Attention:

If Zabbix components are compiled with OpenSSL and CRLs are used, ensure that each top-level and intermediate CA in the certificate chains has a corresponding CRL (even if it is empty) included in the `TLSCRLFile`.

2 Using pre-shared keys

Overview

Each pre-shared key (PSK) in Zabbix actually is a pair of:

- non-secret PSK identity string,
- secret PSK string value.

PSK identity string is a non-empty UTF-8 string. For example, "PSK ID 001 Zabbix agentd". It is a unique name by which this specific PSK is referred to by Zabbix components. Do not put sensitive information in PSK identity string - it is transmitted over the network unencrypted.

PSK value is a hard to guess string of hexadecimal digits, for example, "e560cb0d918d26d31b4f642181f5f570ad89a390931102e5391d08327b".

Size limits

There are size limits for PSK identity and value in Zabbix, in some cases a crypto library can have lower limit:

Component	PSK identity max size	PSK value min size	PSK value max size
<i>Zabbix</i>	128 UTF-8 characters	128-bit (16-byte PSK, entered as 32 hexadecimal digits)	2048-bit (256-byte PSK, entered as 512 hexadecimal digits)
<i>GnuTLS</i>	128 bytes (may include UTF-8 characters)	-	2048-bit (256-byte PSK, entered as 512 hexadecimal digits)
<i>OpenSSL 1.0.x, 1.1.0</i>	127 bytes (may include UTF-8 characters)	-	2048-bit (256-byte PSK, entered as 512 hexadecimal digits)
<i>OpenSSL 1.1.1</i>	127 bytes (may include UTF-8 characters)	-	512-bit (64-byte PSK, entered as 128 hexadecimal digits)
<i>OpenSSL 1.1.1a and later</i>	127 bytes (may include UTF-8 characters)	-	2048-bit (256-byte PSK, entered as 512 hexadecimal digits)

Attention:

Zabbix frontend allows configuring up to 128-character long PSK identity string and 2048-bit long PSK regardless of crypto libraries used.

If some Zabbix components support lower limits, it is the user’s responsibility to configure PSK identity and value with allowed length for these components.

Exceeding length limits results in communication failures between Zabbix components.

Before Zabbix server connects to agent using PSK, the server looks up the PSK identity and PSK value configured for that agent in database (actually in configuration cache). Upon receiving a connection the agent uses PSK identity and PSK value from its configuration file. If both parties have the same PSK identity string and PSK value the connection may succeed.

Attention:

Each PSK identity must be paired with only one value. It is the user’s responsibility to ensure that there are no two PSKs with the same identity string but different values. Failing to do so may lead to unpredictable errors or disruptions of communication between Zabbix components using PSKs with this PSK identity string.

Generating PSK

For example, a 256-bit (32 bytes) PSK can be generated using the following commands:

- with *OpenSSL*:

```
$ openssl rand -hex 32
af8ced32dfe8714e548694e2d29e1a14ba6fa13f216cb35c19d0feb1084b0429
```

- with *GnuTLS*:

```
$ psktool -u psk_identity -p database.psk -s 32
Generating a random key for user 'psk_identity'
Key stored to database.psk
```

```
$ cat database.psk
psk_identity:9b8eafedfaae00cece62e85d5f4792c7d9c9bcc851b23216a1d300311cc4f7cb
```

Note that “psktool” above generates a database file with a PSK identity and its associated PSK. Zabbix expects just a PSK in the PSK file, so the identity string and colon (’:’) should be removed from the file.

Configuring PSK for server-agent communication (example)

On the agent host, write the PSK value into a file, for example, `/home/zabbix/zabbix_agentd.psk`. The file must contain PSK in the first text string, for example:

```
1f87b595725ac58dd977beef14b97461a7c1045b9a1c963065002c5473194952
```

Set access rights to PSK file - it must be readable only by Zabbix user.

Edit TLS parameters in agent configuration file `zabbix_agentd.conf`, for example, set:

```
TLSCConnect=psk
TLSCAccept=psk
TLSPSKFile=/home/zabbix/zabbix_agentd.psk
```

```
TLSPSKIdentity=PSK 001
```

The agent will connect to server (active checks) and accept from server and zabbix_get only connections using PSK. PSK identity will be "PSK 001".

Restart the agent. Now you can test the connection using zabbix_get, for example:

```
zabbix_get -s 127.0.0.1 -k "system.cpu.load[all,avg1]" --tls-connect=psk --tls-psk-identity="PSK 001" --tl
```

(To minimize downtime see how to change connection type in [Connection encryption management](#)).

Configure PSK encryption for this agent in Zabbix frontend:

- Go to: *Data collection* → *Hosts*
- Select host and click on **Encryption** tab

Example:

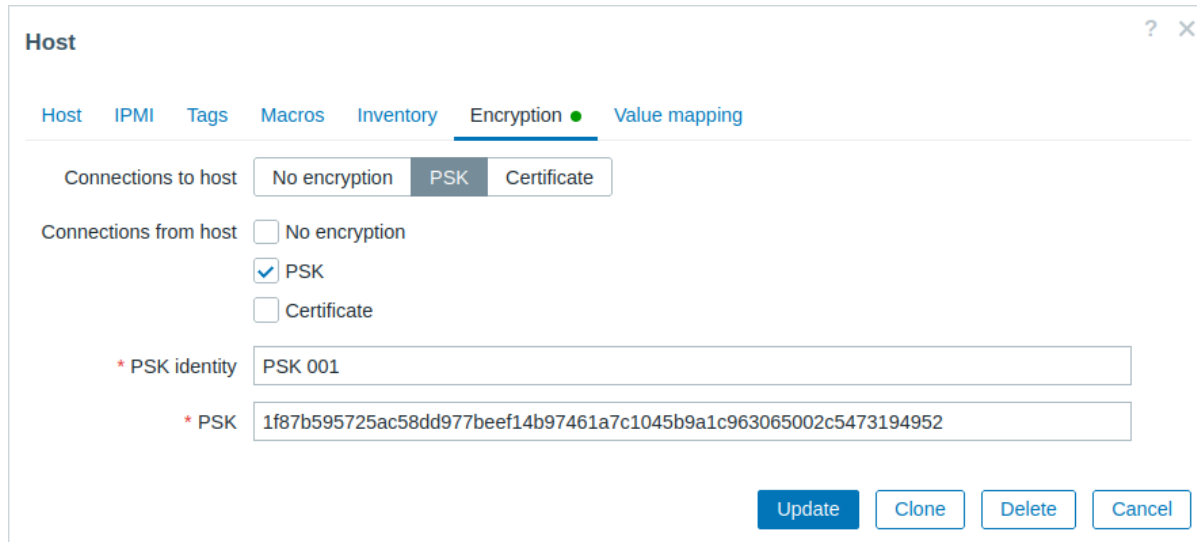

The screenshot shows the 'Host' configuration window in Zabbix. The 'Encryption' tab is active. Under 'Connections to host', the 'PSK' option is selected. Under 'Connections from host', the 'PSK' checkbox is checked. The 'PSK identity' field is filled with 'PSK 001' and the 'PSK' field is filled with the hexadecimal string '1f87b595725ac58dd977beef14b97461a7c1045b9a1c963065002c5473194952'. There are four buttons at the bottom: 'Update', 'Clone', 'Delete', and 'Cancel'.

All mandatory input fields are marked with a red asterisk.

When configuration cache is synchronized with database the new connections will use PSK. Check server and agent logfiles for error messages.

Configuring PSK for server - active proxy communication (example)

On the proxy, write the PSK value into a file, for example, `/home/zabbix/zabbix_proxy.psk`. The file must contain PSK in the first text string, for example:

```
e560cb0d918d26d31b4f642181f5f570ad89a390931102e5391d08327ba434e9
```

Set access rights to PSK file - it must be readable only by Zabbix user.

Edit TLS parameters in proxy configuration file `zabbix_proxy.conf`, for example, set:

```
TLSCConnect=psk
TLSPSKFile=/home/zabbix/zabbix_proxy.psk
TLSPSKIdentity=PSK 002
```

The proxy will connect to server using PSK. PSK identity will be "PSK 002".

(To minimize downtime see how to change connection type in [Connection encryption management](#)).

Configure PSK for this proxy in Zabbix frontend. Go to *Administration* → *Proxies*, select the proxy, go to "Encryption" tab. In "Connections from proxy" mark PSK. Paste into "PSK identity" field "PSK 002" and "e560cb0d918d26d31b4f642181f5f570ad89a390931102e5391d083" into "PSK" field. Click "Update".

Restart proxy. It will start using PSK-based encrypted connections to server. Check server and proxy logfiles for error messages.

For a passive proxy the procedure is very similar. The only difference - set `TLSAccept=psk` in proxy configuration file and set "Connections to proxy" in Zabbix frontend to PSK.

3 Troubleshooting

General recommendations

- Start with understanding which component acts as a TLS client and which one acts as a TLS server in problem case. Zabbix server, proxies and agents, depending on interaction between them, all can work as TLS servers and clients. For example, Zabbix server connecting to agent for a passive check, acts as a TLS client. The agent is in role of TLS server. Zabbix agent, requesting a list of active checks from proxy, acts as a TLS client. The proxy is in role of TLS server. `zabbix_get` and `zabbix_sender` utilities always act as TLS clients.
- Zabbix uses mutual authentication. Each side verifies its peer and may refuse connection. For example, Zabbix server connecting to agent can close connection immediately if agent's certificate is invalid. And vice versa - Zabbix agent accepting a connection from server can close connection if server is not trusted by agent.
- Examine logfiles in both sides - in TLS client and TLS server. The side which refuses connection may log a precise reason why it was refused. Other side often reports rather general error (e.g. "Connection closed by peer", "connection was non-properly terminated").
- Sometimes misconfigured encryption results in confusing error messages in no way pointing to real cause. In subsections below we try to provide a (far from exhaustive) collection of messages and possible causes which could help in troubleshooting. Please note that different crypto toolkits (OpenSSL, GnuTLS) often produce different error messages in same problem situations. Sometimes error messages depend even on particular combination of crypto toolkits on both sides.

1 Connection type or permission problems

Server is configured to connect with PSK to agent but agent accepts only unencrypted connections

In server or proxy log (with *GnuTLS* 3.3.16)

```
Get value from agent failed: zbx_tls_connect(): gnutls_handshake() failed: \
-110 The TLS connection was non-properly terminated.
```

In server or proxy log (with *OpenSSL* 1.0.2c)

```
Get value from agent failed: TCP connection successful, cannot establish TLS to [[127.0.0.1]:10050]: \
Connection closed by peer. Check allowed connection types and access rights
```

One side connects with certificate but other side accepts only PSK or vice versa

In any log (with *GnuTLS*):

```
failed to accept an incoming connection: from 127.0.0.1: zbx_tls_accept(): gnutls_handshake() failed:\
-21 Could not negotiate a supported cipher suite.
```

In any log (with *OpenSSL* 1.0.2c):

```
failed to accept an incoming connection: from 127.0.0.1: TLS handshake returned error code 1:\
file .\ssl\s3_srvr.c line 1411: error:1408A0C1:SSL routines:ssl3_get_client_hello:no shared cipher:\
TLS write fatal alert "handshake failure"
```

Attempting to use Zabbix sender compiled with TLS support to send data to Zabbix server/proxy compiled without TLS

In connecting-side log:

Linux:

```
...In zbx_tls_init_child()
...OpenSSL library (version OpenSSL 1.1.1 11 Sep 2018) initialized
...
...In zbx_tls_connect(): psk_identity:"PSK test sender"
...End of zbx_tls_connect():FAIL error:'connection closed by peer'
...send value error: TCP successful, cannot establish TLS to [[localhost]:10051]: connection closed by peer
```

Windows:

```
...OpenSSL library (version OpenSSL 1.1.1a 20 Nov 2018) initialized
...
...In zbx_tls_connect(): psk_identity:"PSK test sender"
...zbx_psk_client_cb() requested PSK identity "PSK test sender"
...End of zbx_tls_connect():FAIL error:'SSL_connect() I/O error: [0x00000000] The operation completed successfully'
...send value error: TCP successful, cannot establish TLS to [[192.168.1.2]:10051]: SSL_connect() I/O error
```

In accepting-side log:

...failed to accept an incoming connection: from 127.0.0.1: support for TLS was not compiled in
One side connects with PSK but other side uses LibreSSL or has been compiled without encryption support
LibreSSL does not support PSK.

In connecting-side log:

...TCP successful, cannot establish TLS to [[192.168.1.2]:10050]: SSL_connect() I/O error: [0] Success

In accepting-side log:

...failed to accept an incoming connection: from 192.168.1.2: support for PSK was not compiled in

In Zabbix frontend:

Get value from agent failed: TCP successful, cannot establish TLS to [[192.168.1.2]:10050]: SSL_connect()

One side connects with PSK but other side uses OpenSSL with PSK support disabled

In connecting-side log:

...TCP successful, cannot establish TLS to [[192.168.1.2]:10050]: SSL_connect() set result code to SSL_ERR

In accepting-side log:

...failed to accept an incoming connection: from 192.168.1.2: TLS handshake set result code to 1: file ssl

2 Certificate problems

OpenSSL used with CRLs and for some CA in the certificate chain its CRL is not included in TLSCRLFile

In TLS server log in case of *OpenSSL* peer:

failed to accept an incoming connection: from 127.0.0.1: TLS handshake with 127.0.0.1 returned error code
file s3_srvr.c line 3251: error:14089086: SSL routines:ssl3_get_client_certificate:certificate verify
TLS write fatal alert "unknown CA"

In TLS server log in case of *GnuTLS* peer:

failed to accept an incoming connection: from 127.0.0.1: TLS handshake with 127.0.0.1 returned error code
file rsa_pk1.c line 103: error:0407006A: rsa routines:RSA_padding_check_PKCS1_type_1:\
block type is not 01 file rsa_eay.c line 705: error:04067072: rsa routines:RSA_EAY_PUBLIC_DECRYPT:padding

CRL expired or expires during server operation

OpenSSL, in server log:

- before expiration:

cannot connect to proxy "proxy-openssl-1.0.1e": TCP successful, cannot establish TLS to [[127.0.0.1]:20004
SSL_connect() returned SSL_ERROR_SSL: file s3_clnt.c line 1253: error:14090086:\
SSL routines:ssl3_get_server_certificate:certificate verify failed:\
TLS write fatal alert "certificate revoked"

- after expiration:

cannot connect to proxy "proxy-openssl-1.0.1e": TCP successful, cannot establish TLS to [[127.0.0.1]:20004
SSL_connect() returned SSL_ERROR_SSL: file s3_clnt.c line 1253: error:14090086:\
SSL routines:ssl3_get_server_certificate:certificate verify failed:\
TLS write fatal alert "certificate expired"

The point here is that with valid CRL a revoked certificate is reported as "certificate revoked". When CRL expires the error message changes to "certificate expired" which is quite misleading.

GnuTLS, in server log:

- before and after expiration the same:

cannot connect to proxy "proxy-openssl-1.0.1e": TCP successful, cannot establish TLS to [[127.0.0.1]:20004
invalid peer certificate: The certificate is NOT trusted. The certificate chain is revoked.

Self-signed certificate, unknown CA

OpenSSL, in log:

```
error:'self signed certificate: SSL_connect() set result code to SSL_ERROR_SSL: file ../ssl/statem/statem_
line 1924: error:1416F086:SSL routines:tls_process_server_certificate:certificate verify failed:\
TLS write fatal alert "unknown CA"'
```

This was observed when server certificate by mistake had the same Issuer and Subject string, although it was signed by CA. Issuer and Subject are equal in top-level CA certificate, but they cannot be equal in server certificate. (The same applies to proxy and agent certificates.)

To check whether a certificate contains the same Issuer and Subject entries, run:

```
openssl x509 -in <yourcertificate.crt> -noout -text
```

It is acceptable for the root (top-level) certificate to have identical values for Issuer and Subject.

3 PSK problems

PSK contains an odd number of hex-digits

Proxy or agent does not start, message in the proxy or agent log:

```
invalid PSK in file "/home/zabbix/zabbix_proxy.psk"
```

PSK identity string longer than 128 bytes is passed to GnuTLS

In TLS client side log:

```
gnutls_handshake() failed: -110 The TLS connection was non-properly terminated.
```

In TLS server side log.

```
gnutls_handshake() failed: -90 The SRP username supplied is illegal.
```

Too long PSK value used with OpenSSL 1.1.1

In connecting-side log:

```
...OpenSSL library (version OpenSSL 1.1.1 11 Sep 2018) initialized
...
...In zbx_tls_connect(): psk_identity:"PSK 1"
...zbx_psk_client_cb() requested PSK identity "PSK 1"
...End of zbx_tls_connect():FAIL error:'SSL_connect() set result code to SSL_ERROR_SSL: file ssl\statem\ex
```

In accepting-side log:

```
...Message from 123.123.123.123 is missing header. Message ignored.
```

This problem typically arises when upgrading OpenSSL from 1.0.x or 1.1.0 to 1.1.1 and if the PSK value is longer than 512-bit (64-byte PSK, entered as 128 hexadecimal digits).

See also: [Value size limits](#)

18 Web interface

Overview For an easy access to Zabbix from anywhere and from any platform, the web-based interface is provided.

Note:

If using more than one frontend instance make sure that the locales and libraries (LDAP, SAML etc.) are installed and configured identically for all frontends.

Frontend help A help link  is provided in Zabbix frontend forms with direct links to the corresponding parts of the documentation.

1 Menu

Overview

A vertical menu in a sidebar provides access to various Zabbix frontend sections.

The menu is dark blue in the default theme.

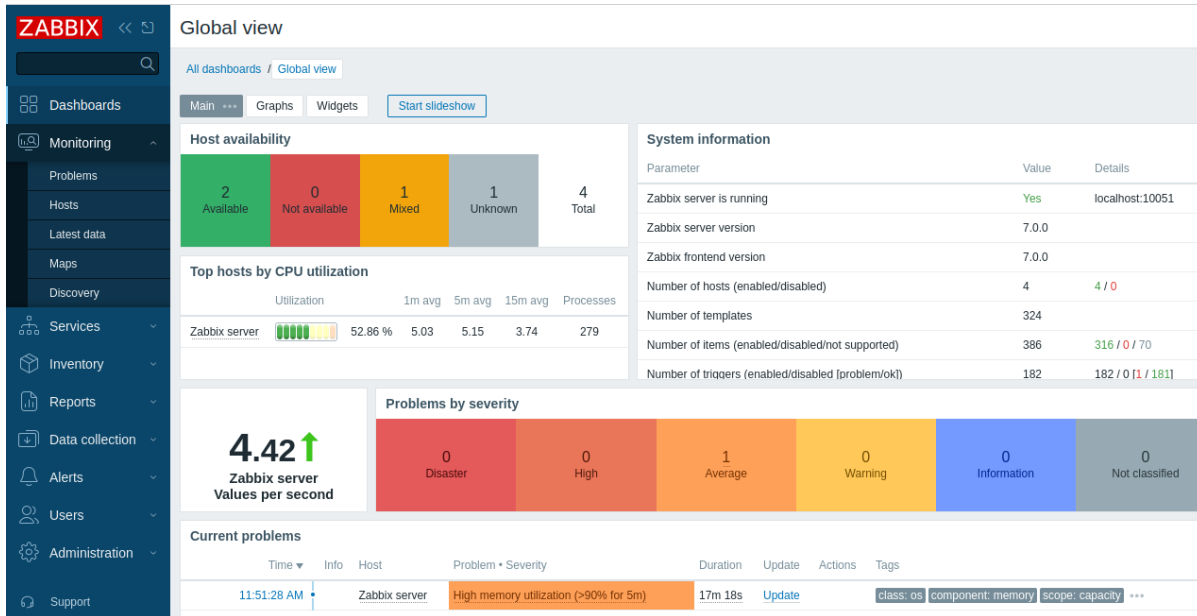

Working with the menu

A **global search** box is located below the Zabbix logo.

The menu can be collapsed or hidden completely:

- To collapse, click on  next to Zabbix logo. In the collapsed menu only the icons are visible.



- To hide, click on  next to Zabbix logo. In the hidden menu everything is hidden.

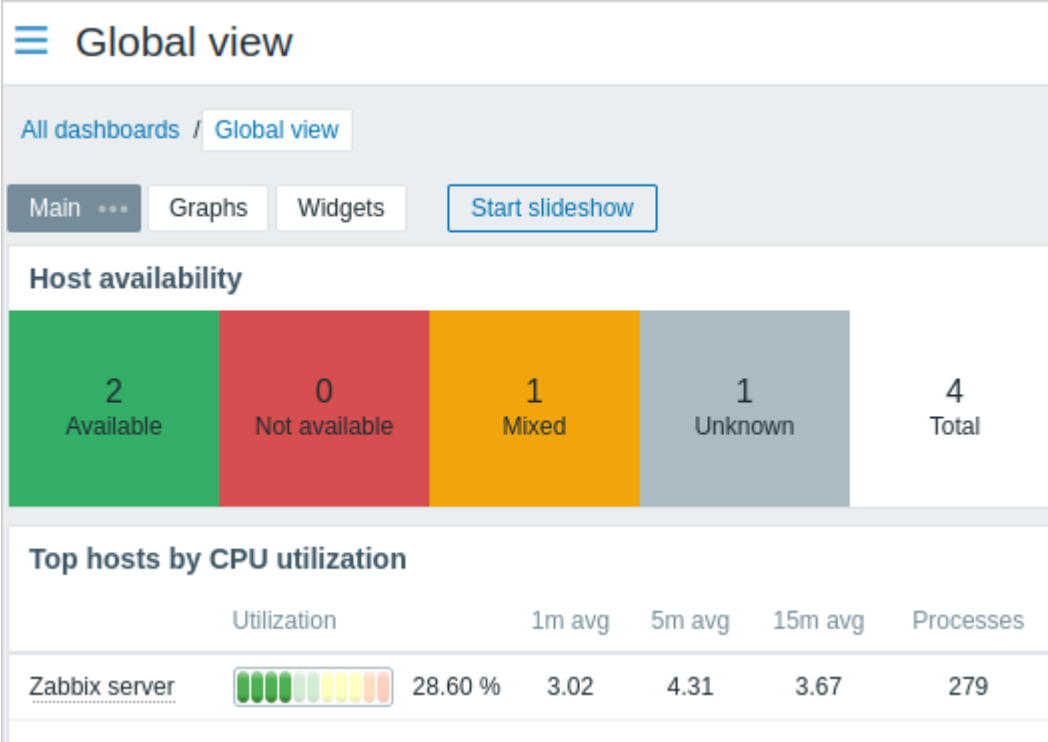

The screenshot shows the Zabbix 'Global view' dashboard. At the top, there is a navigation bar with a hamburger menu icon, the text 'Global view', and a breadcrumb 'All dashboards / Global view'. Below this are tabs for 'Main', 'Graphs', and 'Widgets', along with a 'Start slideshow' button. The main content area is divided into two sections:

Host availability

2 Available	0 Not available	1 Mixed	1 Unknown	4 Total
----------------	--------------------	------------	--------------	------------

Top hosts by CPU utilization

	Utilization	1m avg	5m avg	15m avg	Processes
Zabbix server	 28.60 %	3.02	4.31	3.67	279

Collapsed menu

When the menu is collapsed to icons only, a full menu reappears as soon as the mouse cursor is placed upon it. Note that it reappears over page content; to move page content to the right you have to click on the expand button. If the mouse cursor again is placed outside the full menu, the menu will collapse again after two seconds.

You can also make a collapsed menu reappear fully by hitting the Tab key. Hitting the Tab key repeatedly will allow to focus on the next menu element.

Hidden menu

Even when the menu is hidden completely, a full menu is just one mouse click away, by clicking on the burger icon . Note that it reappears over page content; to move page content to the right you have to unhide the menu by clicking on the show sidebar button.

Menu levels

There are up to three levels in the menu.

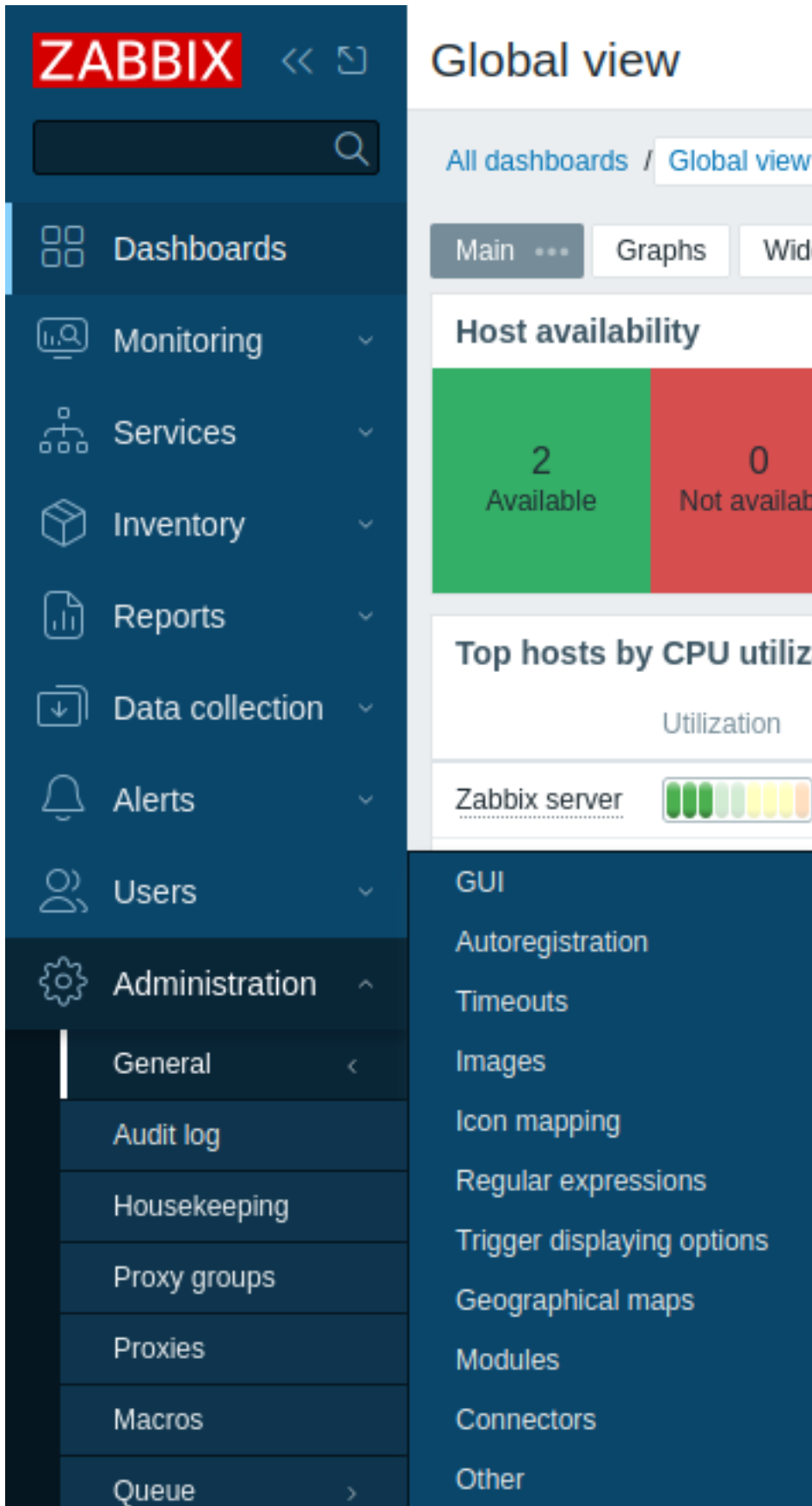

Context menus

In addition to the main menu, Zabbix provides context menus for **host**, **item**, and **event** for quick access to frequently used entities, such as the latest values, simple graph, configuration form, related scripts or external links.

The context menus are accessible by clicking on the host, item or problem/trigger name in supported locations.

1 Event menu

Overview

The event menu contains shortcuts to actions or frontend sections that are frequently required for an event.

The event menu can be opened by clicking on the event name.

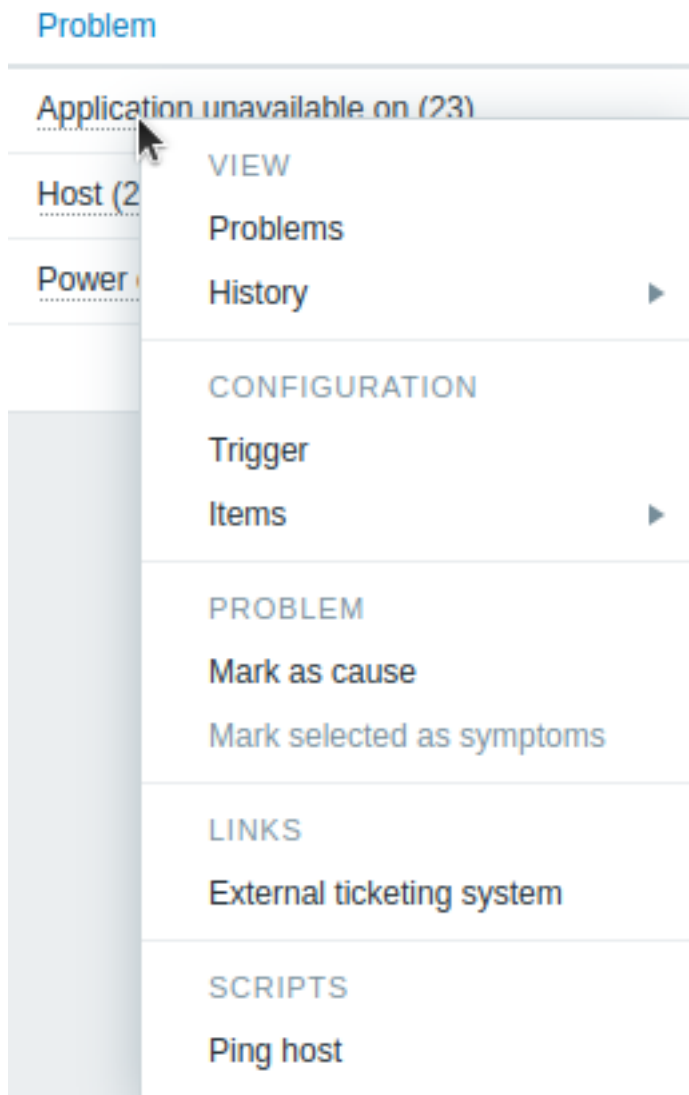

Content

The event context menu has six sections: *View*, *Actions*, *Configuration*, *Problem*, *Links*, and *Scripts*. For the entities that are not configured, links are disabled and displayed in gray. The sections *Scripts* and *Links* are displayed if their entities are configured.

The *View* section contains links to:

- **Problems** - opens the list of unresolved problems of the underlying trigger;
- **History** - leads to the *Latest data* graph/item history for the underlying item(s). If a trigger uses several items, links will be available for each of them.

The *Actions* section is available in *Trigger overview* widgets only. It contains a link to:

- **Update problem** - opens the **problem update** screen.

The *Configuration* section contains links to the configuration of:

- **Trigger** that fired the problem;
- **Items** used in the trigger expression.

Note:

Note that configuration section is available only for Admin and Super admin users.

The *Problem* section contains the options to:

- **Mark as cause** - mark the problem as cause;
- **Mark selected as symptoms** - mark the selected problems as symptoms of this problem.

The *Links* section contains links to:

- access a configured **trigger URL**;
- access custom links configured in **Global scripts** (with scope 'Manual event action' and type 'URL');
- access a configured external ticket for the problem (see the *Include event menu entry* option when configuring **webhooks**).

The *Scripts* section contains links to execute a global **script** (with scope *Manual event action*). This feature may be handy for running scripts used for managing problem tickets in external systems.

Supported locations

The event context menu is accessible by clicking on a problem or event name in various frontend sections, for example:

- Dashboards **widgets**, such as *Problems* widget, *Trigger overview* widget, etc.
- Monitoring → **Problems**
- Monitoring → **Problems** → Event details
- Reports → **Top 100 triggers** (global scripts and access to external ticket are not supported in this location)

2 Host menu

Overview

The host menu contains shortcuts to actions or frontend sections that are frequently required for a host.

The host menu can be opened by clicking on the host name.

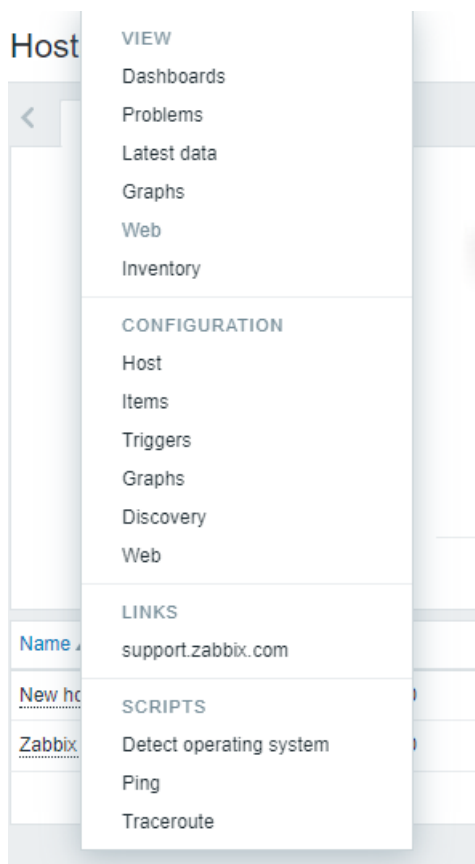

Content

The host context menu has four sections: *View*, *Configuration*, *Links*, and *Scripts*. For the entities that are not configured, links are disabled and displayed in gray color. The sections *Scripts* and *Links* are displayed if their entities are configured.

View section contains links to:

- **Dashboards** - opens widgets and graphs.
- **Problems** - opens the *Problems* section with the list of unresolved problems of the underlying trigger.
- **Latest data** - opens the *Latest data* section with the list of all the latest data of the current host.
- **Graphs** - opens simple graphs of the current host.
- **Web** - opens the link to the configured web scenarios.

- **Inventory** - opens the link to the inventory of the current host.

Configuration section contains links to:

- **Host** - configuration form of the current host.
- **Items** - the list of the current host items.
- **Triggers** - the list of the current host triggers.
- **Graphs** - simple graphs of the current host.
- **Discovery** - the list of low-level discovery rules of the current host.
- **Web** - the list of web scenarios of the current host.

Note:

Note that configuration section is available only for Admin and Super admin users.

Links section contains links to:

- access a configured **trigger URL**.
- access custom links configured in **Global scripts** (with scope *Manual host action* and type 'URL').

Scripts section allows to execute **global scripts** configured for the current host. These scripts need to have their scope defined as *Manual host action* to be available in the host menu.

Supported locations

The host menu is accessible by clicking on a host in various frontend sections, for example:

- Dashboards **widgets**, such as Problems, Top items, Trigger overview, etc.
- Monitoring → **Problems**
- Monitoring → **Problems** → Event details
- Monitoring → **Hosts**
- Monitoring → Hosts → **Web Monitoring**
- Monitoring → **Latest data**
- Monitoring → **Maps**
- Inventory → **Hosts**
- Reports → **Top 100 triggers**

3 Item menu

Overview

The item menu contains shortcuts to actions or frontend sections that are frequently required for an item.

The item menu can be opened by clicking on the item name or the three-dot icon, depending on the frontend section, for example:

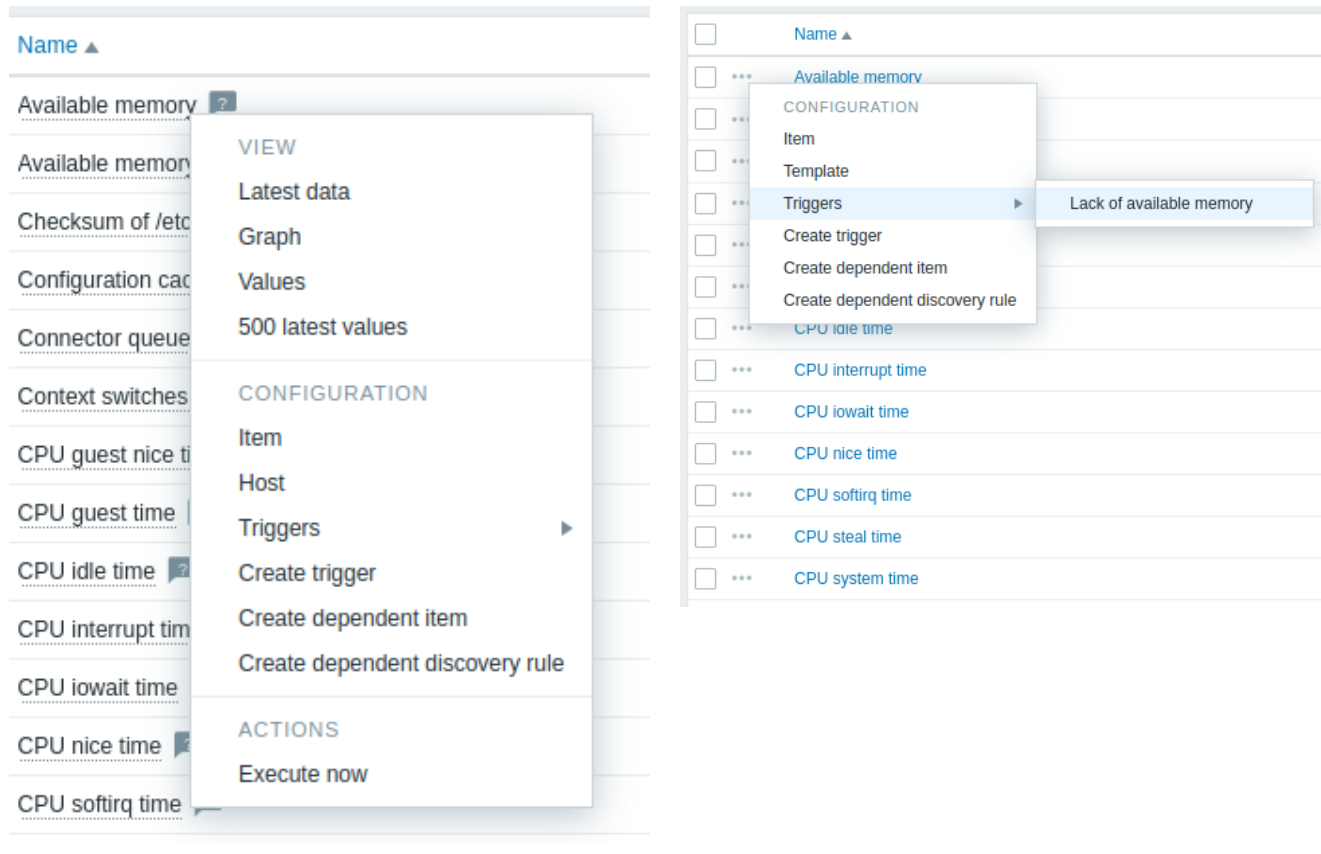

Content

The item menu has three sections: *View*, *Configuration*, and *Actions*.

The *View* section contains the following options:

- **Latest data** - opens the *Latest data* section filtered by the current host and item;
- **Graph** - opens a *simple graph* of the current item;
- **Values** - opens the list of all *values* received for the current item within the past 60 minutes;
- **500 latest values** - opens the list of *500 latest values* for the current item.

The *Configuration* section (available only for *Admin* and *Super admin* type users) contains the following options:

- **Item** - opens the *item configuration form* of the current item;
- **Template** - opens the *template configuration form* of the template that the item belongs to (available only when the item menu is accessed from *Data collection → Templates → Items*);
- **Host** - opens the *host configuration form* of the host that the item belongs to;
- **Triggers** - on mouseover, opens a list of item's triggers, if any; clicking on a trigger opens its *trigger configuration form*;
- **Create trigger** - opens the *trigger configuration form* to create a trigger for this item;
- **Create dependent item** - opens the *item configuration form* to create a dependent item, with the current item as the master item;
- **Create dependent discovery rule** - opens the *discovery rule configuration form* to create a dependent discovery rule, with the current item as the master item.

The *Actions* section contains the following option:

- **Execute now** - *executes a check* for a new item value immediately.

Supported locations

The item menu is accessible by clicking on an item name in various frontend sections, for example:

- Monitoring → *Latest data*
- Data collection → Hosts → *Items*
- Data collection → Hosts → Discovery rules → *Item prototypes*

The item menu is accessible by clicking on an item value in the *Top items* dashboard widget.

2 Frontend sections

Menu structure The Zabbix frontend menu has the following structure:

- Dashboards
- Monitoring
 - Problems
 - Hosts
 - Latest data
 - Maps
 - Discovery
- Services
 - Services
 - SLA
 - SLA report
- Inventory
 - Overview
 - Hosts
- Reports
 - System information
 - Scheduled reports
 - Availability report
 - Top 100 triggers
 - Audit log
 - Action log
 - Notifications
- Data collection
 - Template groups
 - Host groups
 - Templates
 - Hosts
 - Maintenance
 - Event correlation
 - Discovery
- Alerts
 - Actions
 - * Trigger actions
 - * Service actions
 - * Discovery actions
 - * Autoregistration actions
 - * Internal actions
 - Media types
 - Scripts
- Users
 - User groups
 - User roles
 - Users
 - API tokens
 - Authentication
- Administration
 - General
 - * GUI
 - * Autoregistration
 - * Images
 - * Icon mapping
 - * Regular expressions
 - * Trigger displaying options
 - * Geographical maps
 - * Modules
 - * Other
 - Audit log

- Housekeeping
- Proxy groups
- Proxies
- Macros
- Queue
 - * Queue overview
 - * Queue overview by proxy
 - * Queue details

1 Dashboards

Overview

The *Dashboards* section is designed to display summaries of all the important information in a **dashboard**.

While only one dashboard can be displayed at one time, it is possible to configure several dashboards. Each dashboard may contain one or several pages that can be rotated in a slideshow.

A dashboard page consists of widgets and each widget is designed to display information of a certain kind and source, which can be a summary, a map, a graph, the clock, etc.

Access to hosts in the widgets depends on host **permissions**.

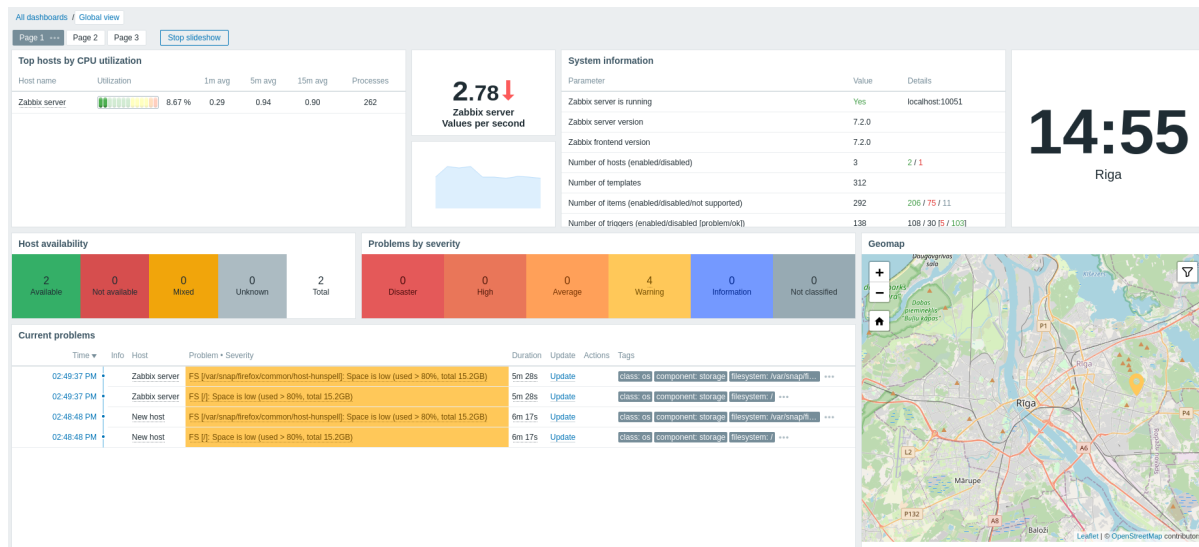

Pages and widgets are added to the dashboard and edited in the dashboard editing mode. Pages can be viewed and rotated in the dashboard viewing mode.

The time period that is displayed in graph widgets is controlled by the *Time period selector* located above the widgets. The *Time period selector* label, located to the right, displays the currently selected time period. Clicking the tab label allows expanding and collapsing the *Time period selector*.

Note that when the dashboard is displayed in kiosk mode and widgets only are displayed, it is possible to zoom out the graph period by double-clicking in the graph.

Dashboard size

The minimum width of a dashboard is 1200 pixels. The dashboard will not shrink below this width; instead a horizontal scrollbar is displayed if the browser window is smaller than that.

The maximum width of a dashboard is the browser window width. Dashboard widgets stretch horizontally to fit the window. At the same time, a dashboard widget cannot be stretched horizontally beyond the window limits.

Horizontally, the dashboard is made up of 72 columns of always equal width that stretch/shrink dynamically (but not to less than 1200 pixels total).

Vertically, the dashboard may contain a maximum of 64 rows; each row has a fixed height of 70 pixels.

A widget may be therefore be up to 72 columns wide and 64 rows high.

Viewing dashboards

To view all configured dashboards, click on *All dashboards* just below the section title.

		Filter
<input type="checkbox"/>	Name ▲	
<input type="checkbox"/>	Apache info	My Shared
<input type="checkbox"/>	Global view	My Shared
<input type="checkbox"/>	HyperV (John's custom)	My
<input type="checkbox"/>	Problems (quick view)	My
<input type="checkbox"/>	Zabbix server	My Shared
<input type="checkbox"/>	Zabbix server health	My Shared

Dashboards are displayed with a **sharing** tag:

- *My* - indicates a private dashboard
- *Shared* - indicates a public dashboard or a private dashboard shared with any user or user group

The filter located to the right above the list allows to filter dashboards by name and by those created by the current user.

To delete one or several dashboards, mark the checkboxes of the respective dashboards and click on *Delete* below the list.

Viewing a dashboard

To view a single dashboard, click on its name in the list of dashboards.

When **viewing** a dashboard, the following options are available:

Edit dashboard

Switch to the dashboard **editing** mode.
 The editing mode is also opened when a new dashboard is being created and when you click on the edit button of a widget.
 Open the action menu (see action descriptions below).

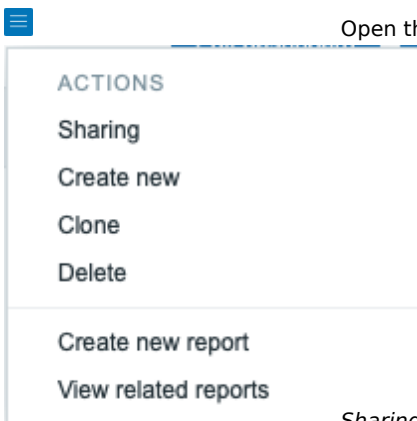

- Sharing* - edit **sharing preferences** for the dashboard.
- Create new* - **create** a new dashboard.
- Clone* - create a new dashboard by copying properties of the existing one. First you are prompted to enter dashboard parameters. Then, the new dashboard opens in editing mode with all the widgets of the original dashboard.
- Delete* - delete the dashboard.
- Create new report* - open a pop-up window with report **configuration form**. Disabled if the user does not have permission to manage scheduled reports.
- View related reports* - open a pop-up window with a list of existing reports based on the current dashboard. Disabled if there are no related reports or the user does not have permission to view scheduled reports.



Display only page content (**kiosk mode**).

Kiosk mode can also be accessed with the following URL parameters:

`/zabbix.php?action=dashboard.view&kiosk=1.`

To exit to normal mode: `/zabbix.php?action=dashboard.view&kiosk=0`

Sharing

Dashboards can be made public or private.

Public dashboards are visible to all users. Private dashboards are visible only to their owner. Private dashboards can be shared by the owner with other users and user groups.

The sharing status of a dashboard is displayed in the list of all dashboards. To edit the sharing status of a dashboard, click on the *Sharing* option in the action menu when viewing a single dashboard:

Parameter	Description
<i>Type</i>	Select dashboard type: Private - dashboard is visible only to selected user groups and users Public - dashboard is visible to all
<i>List of user group shares</i>	Select user groups that the dashboard is accessible to. You may allow read-only or read-write access.
<i>List of user shares</i>	Select users that the dashboard is accessible to. You may allow read-only or read-write access.

Editing a dashboard

When **editing** a dashboard, the following options are available:

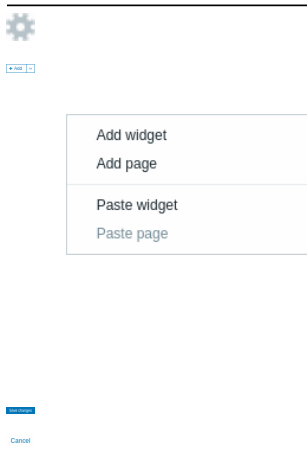

The screenshot shows a gear icon at the top left. Below it is a small 'x' icon in a box. A dropdown menu is open, listing: 'Add widget', 'Add page', 'Paste widget', and 'Paste page'. At the bottom left of the menu area, there is a blue bar with the word 'Cancel'.

Edit general dashboard **parameters**.

Add a new widget.
Clicking on the arrow button will open the action menu (see action descriptions below).

Add widget - add a new widget
Add page - add a new page
Paste widget - paste a copied widget. This option is grayed out if no widget has been copied. Only one entity (widget or page) can be copied at one time.
Paste page - paste a copied page. This option is grayed out if no page has been copied.

Save dashboard changes.
Cancel dashboard changes.

Creating a dashboard

It is possible to create a new dashboard in two ways:

- Click on *Create dashboard*, when viewing all dashboards
- Select *Create new* from the action menu, when viewing a single dashboard

You will be first asked to enter general dashboard parameters:

Dashboard properties ? X

* Owner

* Name

Default page display period ▼

Start slideshow automatically

Parameter	Description
<i>Owner</i>	Select system user that will be the dashboard owner.
<i>Name</i>	Enter dashboard name.
<i>Default page display period</i>	Select period for how long a dashboard page is displayed before rotating to the next page in a slideshow .
<i>Start slideshow automatically</i>	Mark this checkbox to run a slideshow automatically one more than one dashboard page exists.

When you click on *Apply*, an empty dashboard is opened:

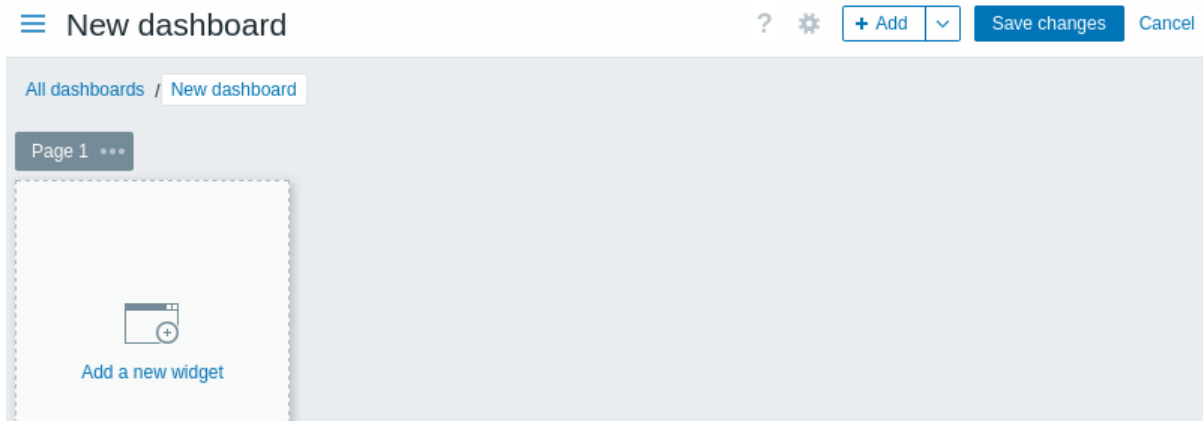

To populate the dashboard, you can add widgets and pages.

Click on the *Save changes* button to save the dashboard. If you click on *Cancel*, the dashboard will not be created.

Adding widgets

To add a widget to a dashboard:



- Click on the  button or the *Add widget* option in the action menu that can be opened by clicking on the arrow. Fill the widget configuration form. The widget will be created in its default size and placed after the existing widgets (if any);

Or

- Move your mouse to the desired empty spot for the new widget. Notice how a placeholder appears, on mouseover, on any empty slot on the dashboard. Then click to open the widget configuration form. After filling the form the widget will be created in its default size or, if its default size is bigger than is available, take up the available space. Alternatively, you may click and drag the placeholder to the desired widget size, then release, and then fill the widget configuration form. (Note that when there is a widget copied onto the clipboard, you will be first prompted to select between *Add widget* and *Paste widget* options to create a widget.)

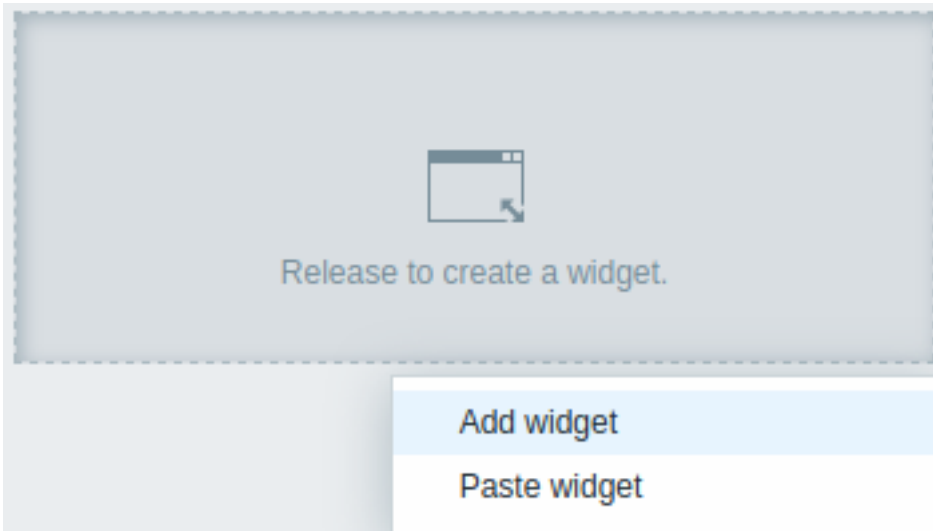

In the widget configuration form:

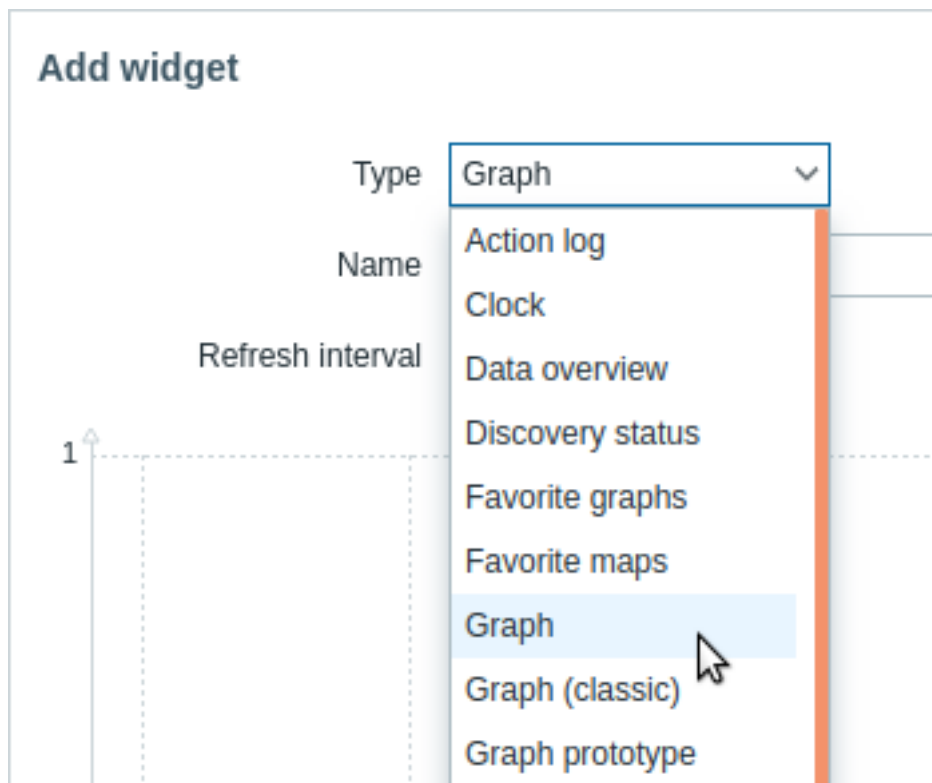

- Select the *Type* of widget
- Enter widget parameters
- Click on *Add*



Widgets

A wide variety of **widgets** (e.g. **Clock**, **Host availability** or **Trigger overview**) can be added to a dashboard: these can be resized and moved around the dashboard in dashboard editing mode by clicking on the widget title bar and dragging it to a new location.

Also, you can click on the following buttons in the top-right corner of the widget to:

-  - edit a widget;
-  - access the **widget menu**

Click on *Save changes* for the dashboard to make any changes to the widgets permanent.

Copying/pasting widgets

Dashboard widgets can be copied and pasted, allowing to create a new widget with the properties of an existing one. They can be copy-pasted within the same dashboard, or between dashboards opened in different tabs.

A widget can be copied using the **widget menu**. To paste the widget:

- click on the arrow next to the *Add* button and selecting the *Paste widget* option, when editing the dashboard
- use the *Paste widget* option when adding a new widget by selecting some area in the dashboard (a widget must be copied first for the paste option to become available)

A copied widget can be used to paste over an existing widget using the *Paste* option in the **widget menu**.

Creating a slideshow

A slideshow will run automatically if the dashboard contains two or more pages (see **Adding pages**) and if one of the following is true:





- The *Start slideshow automatically* option is marked in dashboard properties
- The dashboard URL contains a `slideshow=1` parameter

The pages rotate according to the intervals given in the properties of the dashboard and individual pages. Click on:

- *Stop slideshow* - to stop the slideshow
- *Start slideshow* - to start the slideshow



Slideshow-related controls are also available in **kiosk mode** (where only the page content is shown):

-  - stop slideshow
-  - start slideshow
-  - go back one page
-  - go to the next page

Adding pages

To add a new page to a dashboard:

- Make sure the dashboard is in the **editing mode**
- Click on the arrow next to the *Add* button and select the *Add page* option

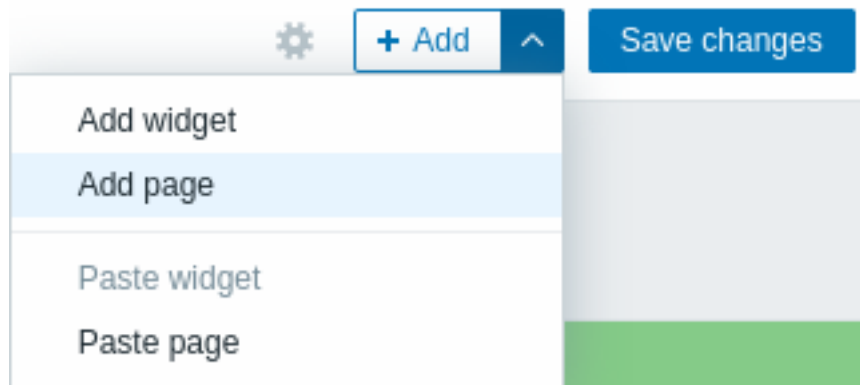

- Fill the general page parameters and click on *Apply*. If you leave the name empty, the page will be added with a Page N name where 'N' is the incremental number of the page. The page display period allows to customize how long a page is displayed in a slideshow.

Dashboard page properties ✕

Name

Page display period ▾

A new page will be added, indicated by a new tab (*Page 2*).

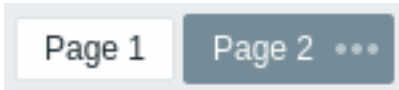

The pages can be reordered by dragging-and-dropping the page tabs. Reordering maintains the original page naming. It is always possible to go to each page by clicking on its tab.

When a new page is added, it is empty. You can add widgets to it as described above.

Copying/pasting pages

Dashboard pages can be copied and pasted, allowing to create a new page with the properties of an existing one. They can be pasted from the same dashboard or a different dashboard.

To paste an existing page to the dashboard, first copy it, using the **page menu**:

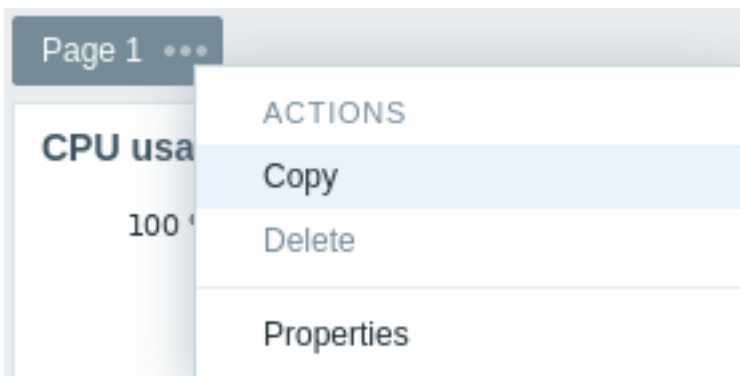

To paste the copied page:

- Make sure the dashboard is in the **editing mode**
- Click on the arrow next to the *Add* button and select the *Paste page* option

Page menu

The page menu can be opened by clicking on the three dots **⋮** next to the page name:

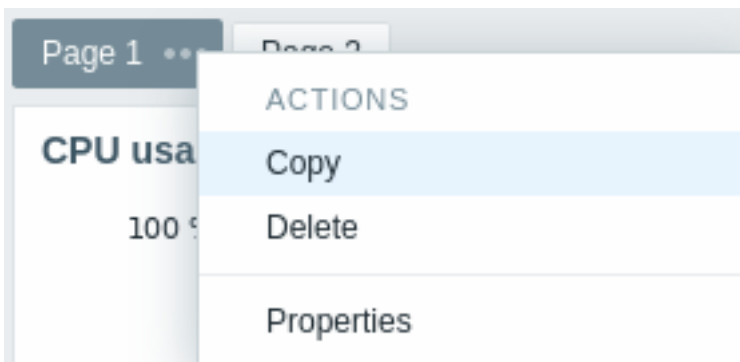

It contains the following options:

- *Copy* - copy the page
- *Delete* - delete the page (pages can only be deleted in the dashboard editing mode)

- *Properties* - customize the page parameters (the name and the page display period in a slideshow)

Widget menu

The widget menu contains different options based on whether the dashboard is in the edit or view mode:

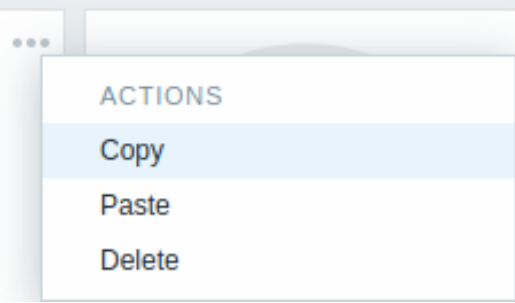
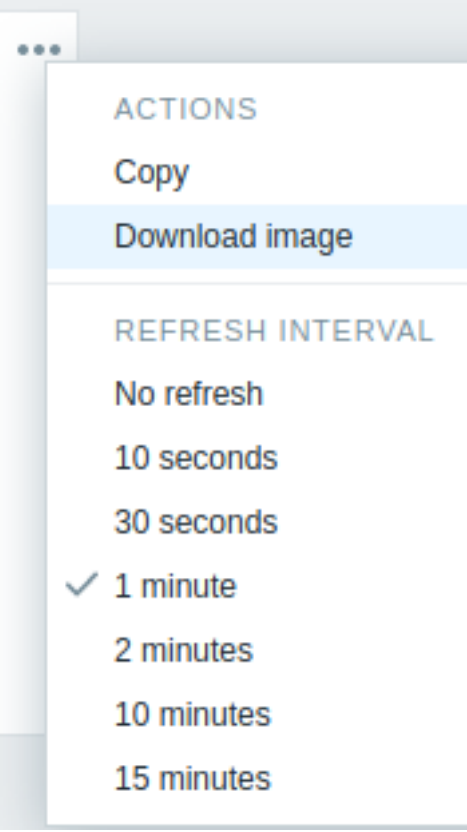
Widget menu	Options
<p>In dashboard edit mode:</p> 	<p><i>Copy</i> - copy the widget <i>Paste</i> - paste a copied widget over this widget This option is grayed out if no widget has been copied. <i>Delete</i> - delete the widget</p>
<p>In dashboard view mode:</p> 	<p><i>Copy</i> - copy the widget <i>Download image</i> - download the widget as a PNG image (only available for graph/classic graph widgets) <i>Refresh interval</i> - select the frequency of refreshing the widget contents</p>

Permissions to dashboards

Permissions to dashboards for regular users and users of 'Admin' type are limited in the following way:

- They can see and clone a dashboard if they have at least READ rights to it;
- They can edit and delete dashboard only if they have READ/WRITE rights to it;
- They cannot change the dashboard owner.

1 Dashboard widgets

Overview

This section provides the details of parameters that are common for **dashboard** widgets.

Common parameters

The following parameters are common for every single widget:

<i>Name</i>	Enter a widget name.
<i>Refresh interval</i>	<p>Configure the default refresh interval.</p> <p>Default refresh intervals for widgets range from <i>No refresh</i> to <i>15 minutes</i> depending on the type of the widget. For example:</p> <ul style="list-style-type: none"> - <i>No refresh</i> for <i>URL</i> widget; - <i>1 minute</i> for <i>Action log</i> widget; - <i>15 minutes</i> for <i>Clock</i> widget. <p>Refresh intervals can be set to a default value for all users. Switch the dashboard to editing mode, click the edit a widget button and select the desired refresh interval from the dropdown list.</p> <p>Each user can also set their own widget refresh interval. In dashboard viewing mode, click the three dots ⋮ button on a widget and select the desired refresh interval from the dropdown list. Note that a user's unique refresh interval takes priority over the widget setting and is preserved even when the widget's setting is modified.</p>
<i>Show header</i>	<p>Mark the checkbox to permanently display the widget header.</p> <p>When unmarked, the header is hidden to save space and becomes visible only on widget mouseover (both in view and edit modes). The header is also semi-visible when dragging a widget to a new place.</p>

Specific parameters

To see specific parameters for each widget, go to individual widget pages:

- [Action log](#)
- [Clock](#)
- [Discovery status](#)
- [Favorite graphs](#)
- [Favorite maps](#)
- [Gauge](#)
- [Geomap](#)
- [Graph](#)
- [Graph \(classic\)](#)
- [Graph prototype](#)
- [Honeycomb](#)
- [Host availability](#)
- [Host card](#)
- [Host navigator](#)
- [Item history](#)
- [Item navigator](#)
- [Item value](#)
- [Map](#)
- [Map navigation tree](#)
- [Pie chart](#)
- [Problem hosts](#)
- [Problems](#)
- [Problems by severity](#)
- [SLA report](#)
- [System information](#)
- [Top hosts](#)
- [Top items](#)
- [Top triggers](#)
- [Trigger overview](#)
- [URL](#)
- [Web monitoring](#)

Dynamic parameters

Multiple widgets have parameters that enable them to share configuration data between other widgets or the dashboard.

Host groups, Hosts, Item, Item list

The *Host groups*, *Hosts*, *Item*, and *Item list* parameters allow selecting either the respective entities or a data source containing either host groups, hosts or items for which the widget can display data.

For *Host groups*, *Item*, and *Item list* parameters, the data source can be a compatible widget from the same dashboard.

For *Hosts* parameter, the data source can be a compatible widget from the same dashboard or the dashboard itself.

Note:

The *Map* widget can also broadcast host group and host data to compatible widgets. For more information, see [Widget behavior](#).

Override host

The *Override host* parameter allows selecting a data source containing a host for which the widget can display data. The data source can be a compatible widget from the same dashboard or the dashboard itself.



- To specify a **compatible widget**, enter its name and select it. Alternatively, click the *Select* button (or the dropdown button, then "Widget") to open a pop-up of available widgets.
- To specify a dashboard, click the dropdown button, then "Dashboard". After **saving** the dashboard, the *Host* field (for selecting hosts) will appear at the top of the dashboard.



Time period

The *Time period* parameter allows selecting a data source containing a time period for which the widget can display data. The data source can be a compatible widget from the same dashboard, the dashboard itself, or the time period configured on the widget itself.

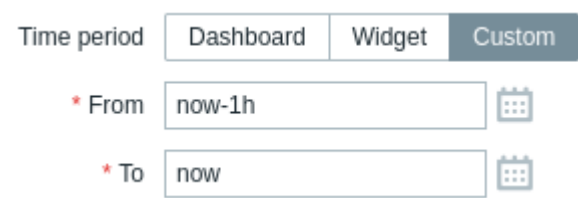

- To specify a **compatible widget**, set *Time period* to "Widget", enter its name and select it. Alternatively, click the *Select* button to open a pop-up of available widgets.
- To specify a dashboard, set *Time period* to "Dashboard". After **saving** the dashboard, the *Time period selector* will appear at the top of the dashboard.
- To configure the time period on the widget itself, set *Time period* to "Custom" and enter or select the start and end of the time period.

Note:

Regardless of the widget's *Time period* configuration, compatible widgets can use it as a data source for the time period.

Widget behavior

Widgets differ in how they **broadcast** data to other widgets.

All widgets capable of broadcasting data begin doing so automatically upon creation. For example, the *Graph* widget immediately broadcasts time period data to listening widgets.

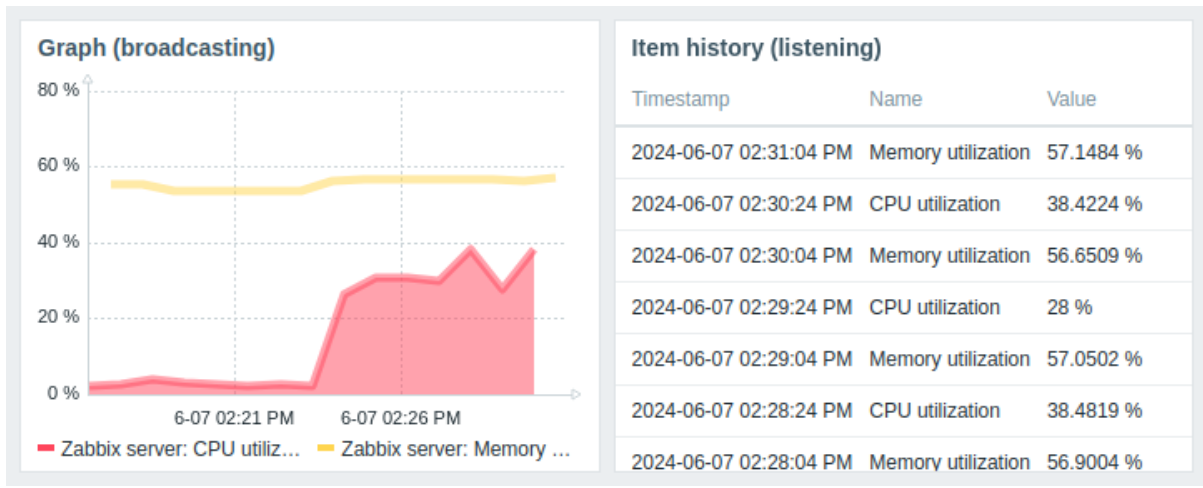

Widgets supporting entity selection (e.g., *Item navigator*) automatically broadcast data for the first available entity. For example, the *Item navigator* widget broadcasts data for the first item in its item list. When a different item is selected, it broadcasts data for that item. On mouseover, the item is highlighted in light blue color; on selection, it is highlighted in yellow color.

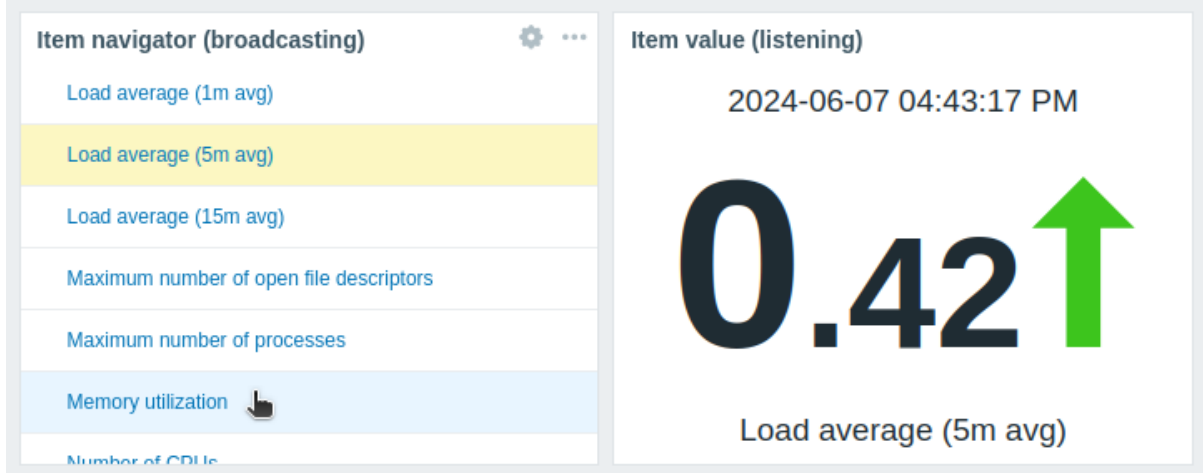

The *Map* widget also automatically broadcasts data for the first available element (e.g., host), which is closest to the top-left corner of the widget's viewport (for *Geomap* widget, closest to the center of the widget's viewport). When a different element is selected, it broadcasts data for that element. On mouseover, the element is highlighted in light blue color; on selection, it is highlighted in dark blue color.

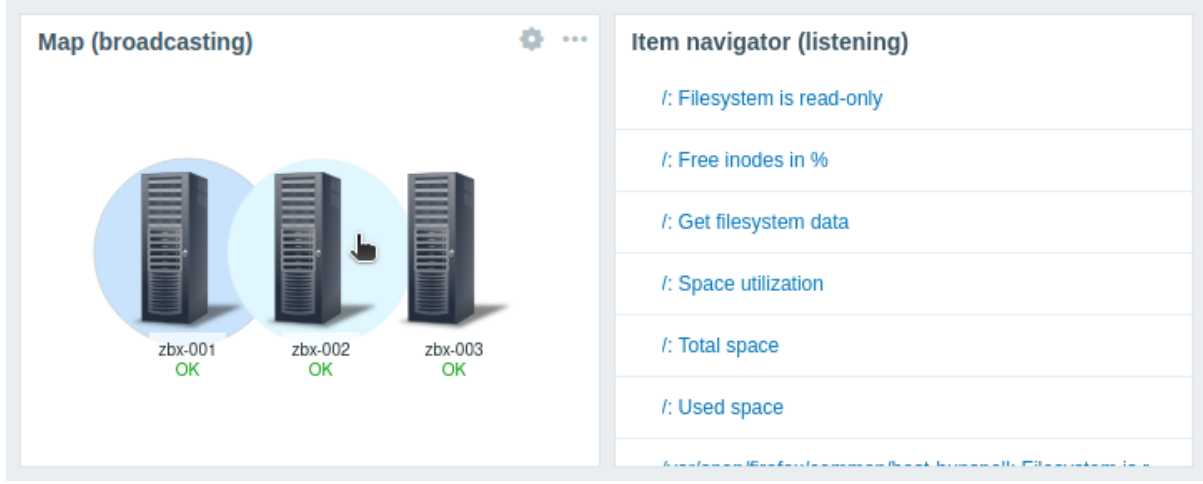

Widgets also have specific behaviors when **listening** for data from other widgets:

- If the data source widget is not broadcasting data, the listening widget enters the *Awaiting data* state.
- If the data source widget has been deleted, replaced with an incompatible widget, or moved to another dashboard page, the listening widget enters the *Referred widget is unavailable* state.
- If the specified host in the data source (widget or dashboard) lacks the entity configured in the listening widget (item, graph, map, etc.) or if the user lacks permissions to access the host, the listening widget displays the following message: *"No permissions to referred object or it does not exist!"*

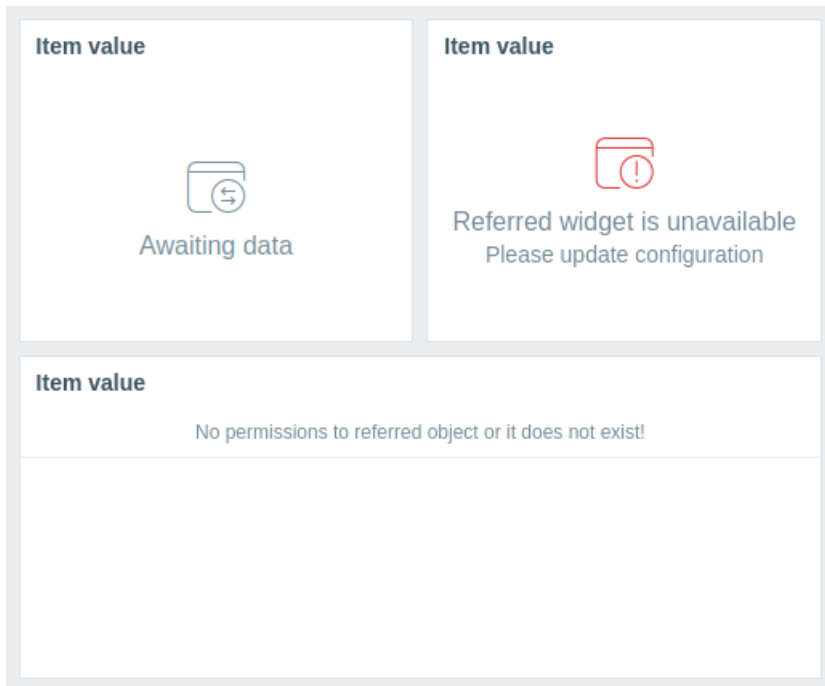

For the broadcasting and listening capabilities of each widget, see [Widget compatibility](#).

Widget compatibility

Some widgets can broadcast configuration data to other widgets, some can listen for data, and some can do both. For example:

- The *Action log* widget can only retrieve time period data from *Graph*, *Graph (classic)*, and *Graph prototype* widgets.
- The *Geomap* widget can broadcast host data to widgets that listen for it (*Honeycomb*, *Top items*, etc.) and can also listen for host group and host data from widgets that broadcast it (*Honeycomb*, *Problem hosts*, etc.).
- The *Clock* widget cannot broadcast or listen for any data.

The following table outlines the broadcasting and listening capabilities of each widget.

Widget	Broadcasts	Listens
<i>Action log</i>	-	Time period
<i>Clock</i>	-	-
<i>Discovery status</i>	-	-
<i>Favorite graphs</i>	-	-
<i>Favorite maps</i>	-	-
<i>Gauge</i>	-	Hosts, Items
<i>Geomap</i>	Hosts	Host groups, Hosts
<i>Graph</i>	Time period	Time period, Items, Hosts
<i>Graph (classic)</i>	Time period	Hosts, Items, Graphs, Time period
<i>Graph prototype</i>	Time period	Hosts, Time period
<i>Honeycomb</i>	Hosts, Items	Host groups, Hosts
<i>Host availability</i>	-	Host groups
<i>Host card</i>	-	Hosts
<i>Host navigator</i>	Hosts	Host groups
<i>Item history</i>	Items	Hosts, Time period
<i>Item navigator</i>	Items	Host groups, Hosts
<i>Item value</i>	-	Hosts, Items, Time period
<i>Map</i>	Host groups, Hosts	Maps
<i>Map navigation tree</i>	Maps	-
<i>Pie chart</i>	-	Time period, Items
<i>Problem hosts</i>	Host groups	Host groups, Hosts
<i>Problems</i>	Events	Host groups, Hosts
<i>Problems by severity</i>	Host groups	Host groups, Hosts
<i>SLA report</i>	-	-
<i>System information</i>	-	-
<i>Top hosts</i>	Hosts	Host groups, Hosts
<i>Top items</i>	-	Host groups, Hosts
<i>Top triggers</i>	-	Time period

Widget	Broadcasts	Listens
<i>Trigger overview</i>	-	Host groups, Hosts
<i>URL</i>	-	Hosts
<i>Web monitoring</i>	Host groups	Host groups, Hosts

1 Action log

Overview

In the action log widget, you can display details of action operations (notifications, remote commands). It replicates information from *Reports* → *Action log*.

Up to 1000 records can be displayed.

Configuration

To configure, select *Action log* as type:

Add widget
? X

Type

Name

Refresh interval

Recipients
type here to search

Actions

Media types
type here to search

Status In progress Sent/Executed Failed

Search string

Time period Dashboard Widget Custom

Sort entries by

* Show lines

Show header

Select

Select

Select

Select

In addition to the parameters that are **common** for all widgets, you may set the following specific options:

<i>Recipients</i>	Filter entries by recipients. This field is auto-complete, so starting to type the name of a recipient will offer a dropdown of matching recipients. If no recipients are selected, details of action operations for all recipients will be displayed.
<i>Actions</i>	Filter entries by actions. This field is auto-complete, so starting to type the name of an action will offer a dropdown of matching actions. If no actions are selected, details of action operations for all actions will be displayed.
<i>Media types</i>	Filter entries by media types. This field is auto-complete, so starting to type the name of a media type will offer a dropdown of matching media types. If no media types are selected, details of action operations for all media types will be displayed.

<i>Status</i>	<p>Mark the checkbox to filter entries by the respective status:</p> <p>In progress - action operations that are in progress are displayed;</p> <p>Sent/Executed - action operations that have sent a notification or have been executed are displayed;</p> <p>Failed - action operations that have failed are displayed.</p>
<i>Search string</i>	<p>Filter entries by the content of the message/remote command. If you enter a string here, only those action operations whose message/remote command contains the entered string will be displayed. Macros are not resolved.</p>
<i>Time period</i>	<p>Filter entries by time period. Select the data source for the time period:</p> <p>Dashboard - set the <i>Time period</i> selector as the data source;</p> <p>Widget - set a compatible widget specified in the <i>Widget</i> parameter as the data source;</p> <p>Custom - set the time period specified in the <i>From</i> and <i>To</i> parameters as the data source; if set, a clock icon will be displayed in the top right corner of the widget, indicating the set time on mouseover.</p>
<i>Widget</i>	<p>Enter or select a compatible widget as the data source for the time period.</p> <p>This parameter is available if <i>Time period</i> is set to "Widget".</p>
<i>From</i>	<p>Enter or select the start of the time period.</p> <p>Relative time syntax (<code>now</code>, <code>now/d</code>, <code>now/w-1w</code>, etc.) is supported.</p> <p>This parameter is available if <i>Time period</i> is set to "Custom".</p>
<i>To</i>	<p>Enter or select the end of the time period.</p> <p>Relative time syntax (<code>now</code>, <code>now/d</code>, <code>now/w-1w</code>, etc.) is supported.</p> <p>This parameter is available if <i>Time period</i> is set to "Custom".</p>
<i>Sort entries by</i>	<p>Sort entries by:</p> <p>Time (descending or ascending);</p> <p>Type (descending or ascending);</p> <p>Status (descending or ascending);</p> <p>Recipient (descending or ascending).</p>
<i>Show lines</i>	<p>Set how many action log lines will be displayed in the widget.</p>

2 Clock

Overview

In the clock widget, you may display local, server, or specified host time.

Both analog and digital clocks can be displayed:





Configuration

To configure, select *Clock* as type:

Add widget ? X

Type Show header

Name

Refresh interval

Time type

Clock type Analog Digital

* Show Date
 Time
 Time zone

Advanced configuration

In addition to the parameters that are **common** for all widgets, you may set the following specific options:

<i>Time type</i>	Select local, server, or specified host time. Server time will be identical to the time zone set globally or for the Zabbix user.
<i>Item</i>	Select the item for displaying time. To display host time, use the <code>system.localtime[local]</code> item. This item must exist on the host. This field is available only when <i>Host time</i> is selected.
<i>Clock type</i>	Select clock type: Analog - analog clock Digital - digital clock
<i>Show</i>	Select information units (date, time, time zone) to display in the digital clock. Unit size is dynamic, filling all available widget space based on displayed units, widget size, and display scaling. This field is available only if "Digital" is selected in the <i>Clock type</i> field; at least one information unit type must be selected.
<i>Advanced configuration</i>	Click on the <i>Advanced configuration</i> label to display advanced configuration options for the digital clock. This section is available only if "Digital" is selected in the <i>Clock type</i> field.

Advanced configuration

Advanced configuration options are available in the collapsible *Advanced configuration* section, and only for those elements that are selected in the *Show* field (see above).

Additionally, advanced configuration allows to change the background color for the whole widget.

Advanced configuration

Background color

Date Bold Color

Time Bold Color
 Seconds Format

Time zone Bold Color
Time zone
 Format

Background color

Select the background color from the color picker.

D stands for default color (depends on the frontend theme). To return to the default value, click the *Use default* button in the color picker.

Date

Bold

Mark the checkbox to display date in bold type.

Color

Select the date color from the color picker.

D stands for default color (depends on the frontend theme). To return to the default value, click the *Use default* button in the color picker.

Time

Bold

Mark the checkbox to display time in bold type.

Color

Select the time color from the color picker.

D stands for default color (depends on the frontend theme). To return to the default value, click the *Use default* button in the color picker.

Seconds

Mark the checkbox to display seconds. Otherwise only hours and minutes will be displayed.

Format

Select to display a 24-hour or 12-hour time.

Time zone

Bold

Mark the checkbox to display time zone in bold type.

Color

Select the time zone color from the color picker.

D stands for default color (depends on the frontend theme). To return to the default value, click the *Use default* button in the color picker.

Time zone

Select the time zone.

Format

Select to display time zone in short format (e.g. New York) or full format (e.g. (UTC-04:00) America/New York).

3 Discovery status

Overview

This widget displays a status summary of the active network discovery rules.

Add widget ? ×

Type Show header

Name

Refresh interval

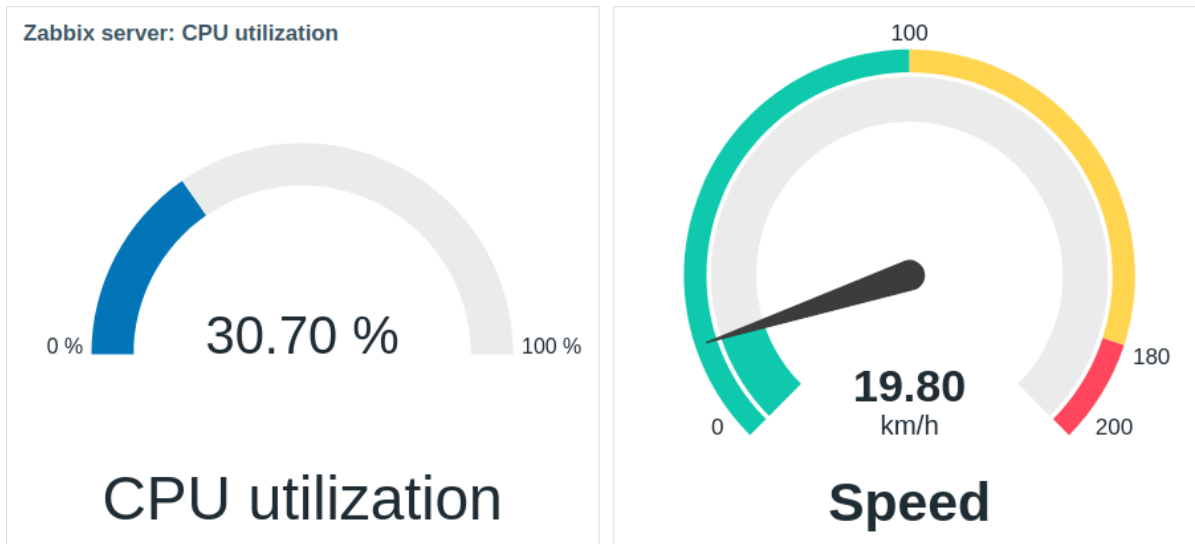

When configured, the widget can consist of the following elements:

- Item description (for example, "CPU utilization", "Speed")
- Item value (for example, "30.70", "19.80")
- Item value units (for example, "%", "km/h")
- Gauge scale (for example, "0%/100%", "0/100/180/200")
- Gauge arc (gauge value arc and gauge thresholds arc)
- Gauge needle

The widget can be visually fine-tuned using the **advanced configuration** options to create a wide variety of visual styles:

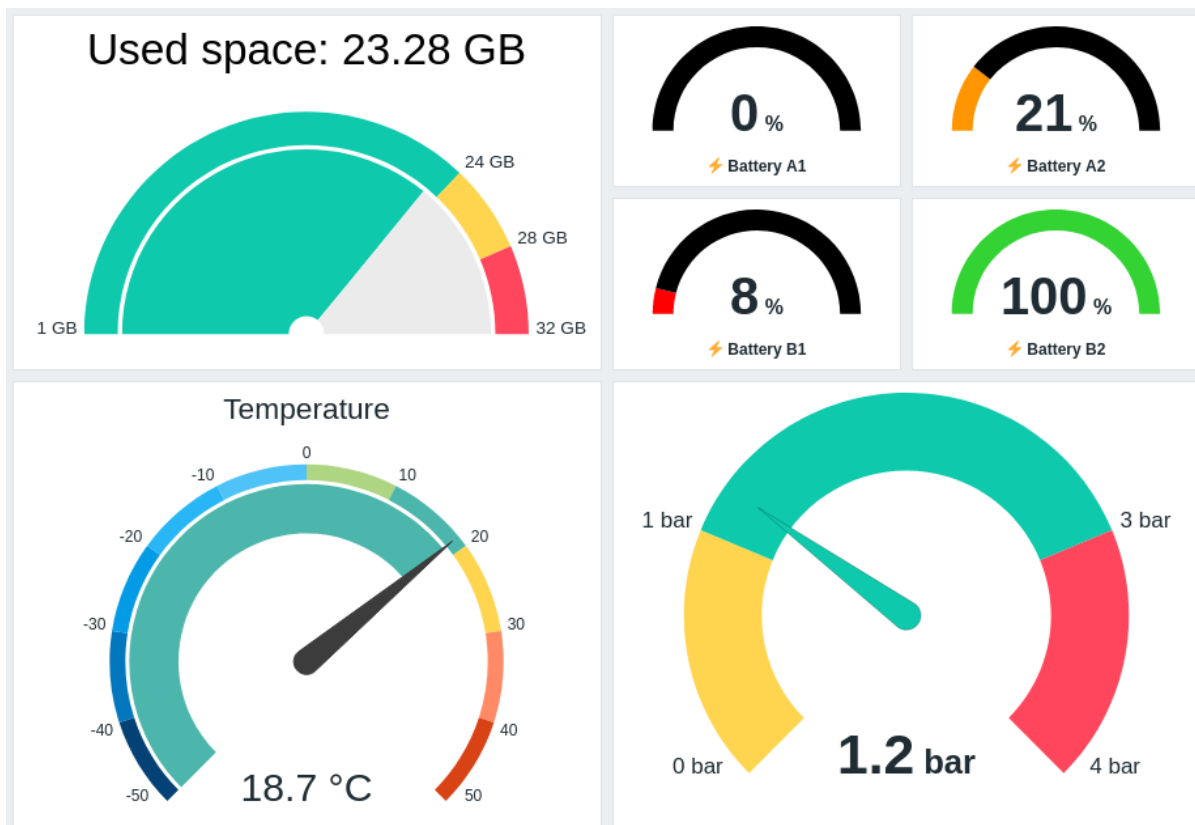

The gauge widget can display only numeric values. Displaying binary values is not supported.

Clicking on the gauge widget leads to a graph for the item.

Configuration

To configure, select *Gauge* as type:

Add widget
? X

Type

Name

Refresh interval

* Item Select

* Min

* Max

Show header

Colors

Value arc

Arc background

Background

* Show

Description

Value

Value arc

Needle

Scale

Override host Select

▼ Advanced configuration

Add Cancel

In addition to the parameters that are **common** for all widgets, you may set the following specific options:

<i>Item</i>	Select the item. Alternatively, select a compatible widget as the data source for items. This field is auto-complete, so starting to type the name of an item will offer a dropdown of matching items. Note that you can select only items that return numeric data.
<i>Min</i>	Enter the minimum value of the gauge. Suffixes (for example, "1d", "2w", "4K", "8G") are supported. Value mappings are supported.
<i>Max</i>	Enter the maximum value of the gauge. Suffixes (for example, "1d", "2w", "4K", "8G") are supported. Value mappings are supported.
<i>Colors</i>	Select the color from the color picker: Value arc - select the gauge value arc color; Arc background - select the gauge value arc and gauge thresholds arc background color; Background - select the widget background color. "D" stands for the default color, which depends on the frontend theme. If Thresholds are set, the default color for Value arc depends on the threshold color. To return to the default color, click the <i>Use default</i> button in the color picker.
<i>Show</i>	Mark the checkbox to display the respective gauge element - description, value, value arc, needle, scale (the minimum and maximum value of the gauge at the beginning and end of the gauge arc). Unmark to hide. At least one element must be selected. Note that the gauge needle and scale can be displayed if the gauge value arc or gauge thresholds arc (see advanced configuration options) is displayed. Also note that if the gauge needle is displayed, the value is placed under the needle; if the needle is hidden, the value is aligned with the bottom of the gauge arc.
<i>Override host</i>	Select a compatible widget or the dashboard as the data source for hosts. This parameter is not available when configuring the widget on a template dashboard .
<i>Advanced configuration</i>	Click the <i>Advanced configuration</i> label to display advanced configuration options. This is also where you'll be able to adjust the gauge elements selected in the <i>Show</i> field.

Advanced configuration

Advanced configuration options are available in the collapsible *Advanced configuration* section:

Advanced configuration

Angle 180° 270°

* Description ?

{ITEM.NAME}

Size %

Vertical position Top Bottom

Bold

Color

Value

Decimal places

Size %

Bold

Color

Units

Size %

Bold

Position ?

Color

Value arc

Size %

Scale

Show units

Size %

Decimal places

Thresholds

Threshold

Action



[Remove](#)



[Remove](#)



[Remove](#)

[Add](#)

Show labels

Show arc

Arc size %

Angle

Select the gauge angle (180° or 270°).

Description

Description

Enter the item description. This description may override the default item name. Multiline descriptions are supported. A combination of text and supported macros is possible. {HOST.*}, {ITEM.*}, {INVENTORY.*} and user macros are supported.

Size

Enter the font size height for the item description (in percent, relative to the total widget height).

Vertical position

Select the vertical position of the item description (top or bottom, relative to the gauge arc).

Bold

Mark the checkbox to display the item description in bold.

Color

Select the item description color from the color picker.

"D" stands for the default color, which depends on the frontend theme. To return to the default color, click the *Use default* button in the color picker.

Value

Decimal places

Enter the number of decimal places to display with the value.

This option affects only items that return **numeric (float)** data.

Size

Enter the font size height for the value (in percent, relative to the gauge arc height).

Bold

Mark the checkbox to display the value in bold.

Color

Select the value color from the color picker.

"D" stands for the default color, which depends on the frontend theme. To return to the default color, click the *Use default* button in the color picker.

Units

Units	Mark the checkbox to display units with the item value. If you enter a unit name, it will override the units set in the item configuration .
Size	Enter the font size height for the item units (in percent, relative to the gauge arc height).
Bold	Mark the checkbox to display item units in bold.
Position	Select the position of the item units (above, below, before or after, relative to the item value). This option is ignored for the following time-related units : unixtime, uptime, s.
Color	Select the item units color from the color picker. "D" stands for the default color, which depends on the frontend theme. To return to the default color, click the <i>Use default</i> button in the color picker.
Value arc	
Arc size	Enter the size height of the gauge value arc (in percent, relative to the gauge arc radius).
Needle	
Color	Select the gauge needle color from the color picker. "D" stands for the default color, which depends on the frontend theme. If <i>Thresholds</i> are set, the default color for the needle depends on the threshold color. To return to the default color, click the <i>Use default</i> button in the color picker.
Scale	
Show units	Mark the checkbox to display units with the minimum and maximum value of the gauge.
Size	Enter the font size height for the minimum and maximum value of the gauge (in percent, relative to the gauge arc height).
Decimal places	Enter the number of decimal places to display with the minimum and maximum value of the gauge. This option affects only items that return numeric (float) data.
Thresholds	
Thresholds	Click <i>Add</i> to add a threshold, select a threshold color from the color picker, and specify a numeric value. The thresholds list will be sorted in ascending order when saved. Note that the colors configured as thresholds will be displayed correctly only for numeric items. Suffixes (for example, "1d", "2w", "4K", "8G") are supported. Value mappings are supported.
Show labels	Mark the checkbox to display threshold values as labels on the gauge scale.
Show arc	Mark the checkbox to display the gauge thresholds arc.
Arc size	Enter the size height of the gauge thresholds arc (in percent, relative to the gauge arc radius).

The information displayed by the gauge widget can be downloaded as a *.png* image using the [widget menu](#):

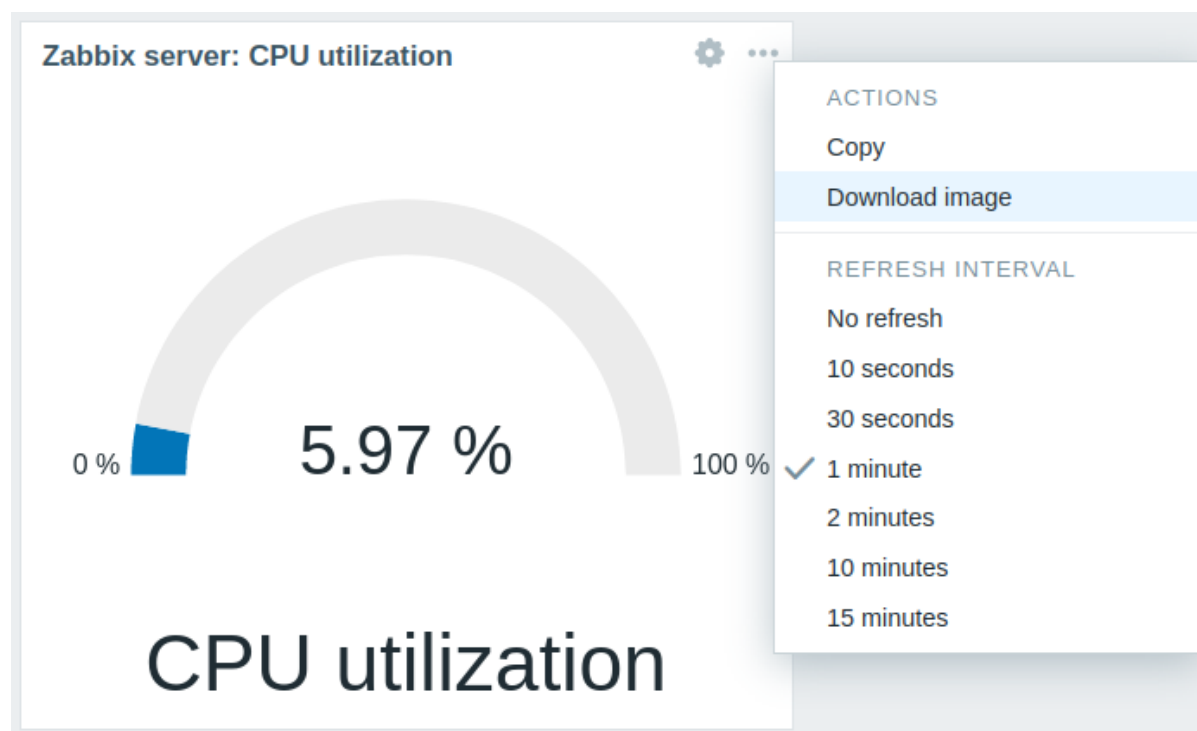

A screenshot of the widget will be saved to the *Downloads* folder.

Overview

Geomap widget displays hosts as markers on a geographical map using open-source JavaScript interactive maps library Leaflet.

Note:

Zabbix offers multiple predefined map tile service providers and an option to add a custom tile service provider or even host tiles themselves (configurable in the *Administration* → *General* → *Geographical maps* menu section).

By default, the widget displays all enabled hosts with valid geographical coordinates defined in the host configuration. It is possible to configure host filtering in the widget parameters.

The valid host coordinates are:

- Latitude: from -90 to 90 (can be integer or float number)
- Longitude: from -180 to 180 (can be integer or float number)

Configuration

To add the widget, select *Geomap* as type.

The screenshot shows the 'Add widget' dialog box with the following configuration options:

- Type:** Geomap (dropdown menu)
- Show header:**
- Name:** default (text input)
- Refresh interval:** Default (1 minute) (dropdown menu)
- Host groups:** type here to search (text input) with a **Select** dropdown button.
- Hosts:** type here to search (text input) with a **Select** dropdown button.
- Tags:** And/Or (selected) or Or (radio buttons)
- Tag configuration:** tag (text input), Contains (dropdown menu), value (text input), and a **Remove** link.
- Initial view:** 40.6892494,-74.0466891 (text input with a help icon).

Buttons at the bottom: **Add** (blue) and **Cancel** (white).

In addition to the parameters that are **common** for all widgets, you may set the following specific options:

Host groups

Select host groups to be displayed on the map.

Alternatively, select a compatible widget as the **data source** for host groups.

This field is auto-complete, so starting to type the name of a group will offer a dropdown of matching groups.

If nothing is selected in both *Host groups* and *Hosts* fields, all hosts with valid coordinates will be displayed.

This parameter is not available when configuring the widget on a **template dashboard**.

Hosts

Select hosts to be displayed on the map.

Alternatively, select a compatible widget or the dashboard as the **data source** for hosts.

This field is auto-complete, so starting to type the name of a host will offer a dropdown of matching hosts.

If nothing is selected in both *Host groups* and *Hosts* fields, all hosts with valid coordinates will be displayed.

This parameter is not available when configuring the widget on a **template dashboard**.

Tags

Specify tags to limit the number of hosts displayed in the widget.

It is possible to include as well as exclude specific tags and tag values. Several conditions can be set. Tag name matching is always case-sensitive.

There are several operators available for each condition:

Exists - include the specified tag names;

Equals - include the specified tag names and values (case-sensitive);

Contains - include the specified tag names where the tag values contain the entered string (substring match, case-insensitive);

Does not exist - exclude the specified tag names;

Does not equal - exclude the specified tag names and values (case-sensitive);

Does not contain - exclude the specified tag names where the tag values contain the entered string (substring match, case-insensitive).

There are two calculation types for conditions:

And/Or - all conditions must be met, conditions having the same tag name will be grouped by the *Or* condition;

Or - enough if one condition is met.

Initial view

This parameter is not available when configuring the widget on a **template dashboard**.

Comma-separated center coordinates and an optional zoom level to display when the widget is initially loaded in the format <latitude>,<longitude>,<zoom>

If initial zoom is specified, the Geomap widget is loaded at the given zoom level. Otherwise, initial zoom is calculated as half of the **max zoom** for the particular tile provider.

The initial view is ignored if the default view is set (see below).

Examples:

40.6892494,-74.0466891,14

40.6892494,-122.0466891

Host markers displayed on the map have the color of the host's most serious problem and green color if a host has no problems. Clicking on a host marker allows viewing the host's visible name and the number of unresolved problems grouped by severity. Clicking on the visible name will open **host menu**.

Hosts displayed on the map can be filtered by problem severity. Press on the filter icon in the widget's upper right corner and mark the required severities.

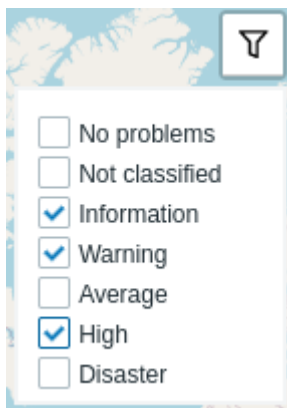

It is possible to zoom in and out the map by using the plus and minus buttons in the widget's upper left corner or by using the mouse scroll wheel or touchpad. To set the current view as default, right-click anywhere on the map and select *Set this view as default*. This setting will override *Initial view* widget parameter for the current user. To undo this action, right-click anywhere on the map again and select *Reset to initial view*.

When *Initial view* or *Default view* is set, you can return to this view at any time by pressing on the home icon on the left.

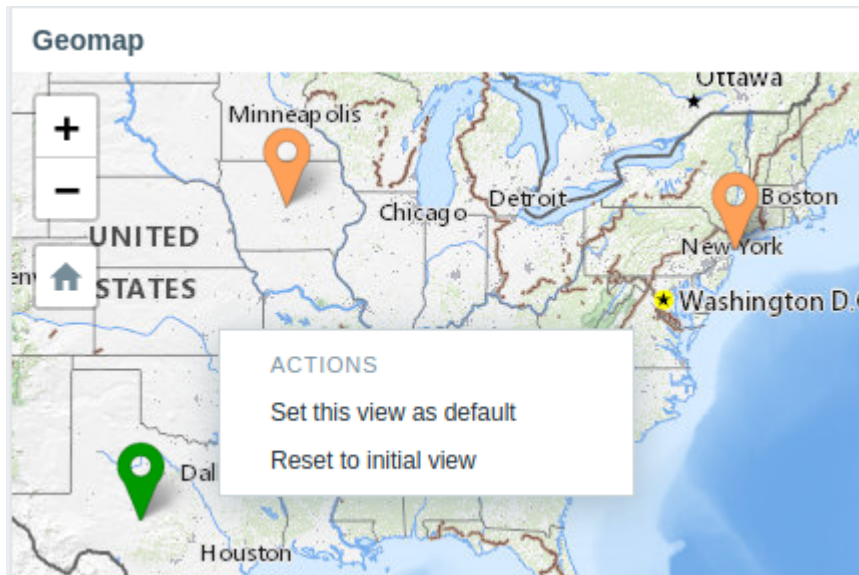

8 Graph

Overview

The graph widget provides a modern and versatile way of visualizing data collected by Zabbix using a vector image drawing technique. This graph widget is supported since Zabbix 4.0. Note that the graph widget supported before Zabbix 4.0 can still be used as *Graph (classic)*. See also *Adding widgets* section on *Dashboards* page for more details.

Configuration

To configure, select *Graph* as type:

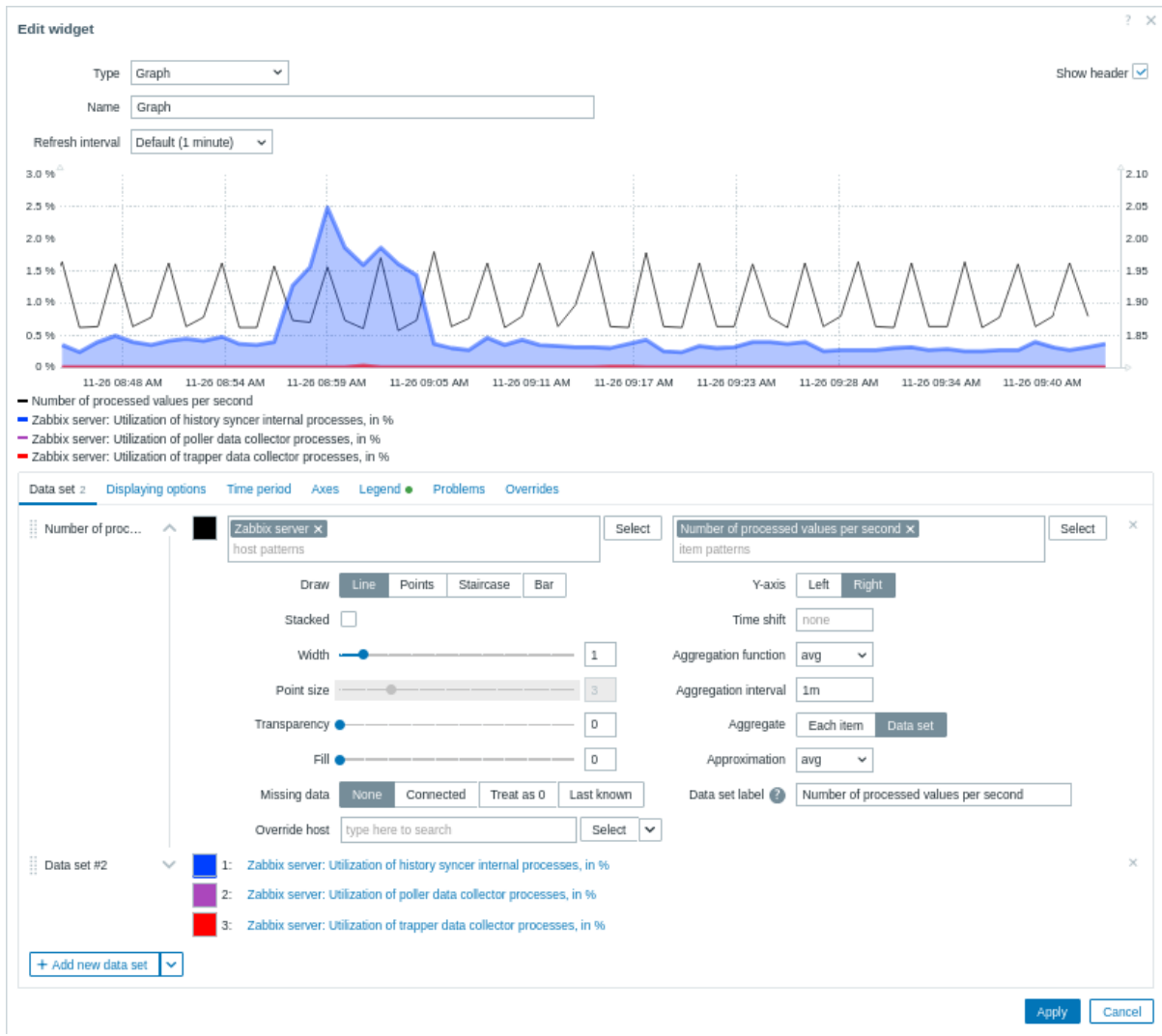

Data set

The **Data set** tab allows selecting data for the graph by adding data sets. Two types of data sets can be added:

- *Item patterns* - data from matching items is displayed. The graph is drawn using different shades of single color for each item.
- *Item list* - data from selected items is displayed. The graph is drawn using different colors for each item.





By default, an *Item patterns* data set is added.

<p><i>Data set</i></p>	<p>For Item patterns data set: Select or enter host and item patterns; data of items that match these patterns will be displayed on the graph; up to 50 items may be displayed. Wildcard patterns may be used for selection (for example, * will return results that match zero or more characters). To specify a wildcard pattern, enter the string manually and press <i>Enter</i>. The wildcard symbol is always interpreted, so it is not possible to add, for example, an item named <i>item*</i> individually if there are other matching items (for example, <i>item2</i>, <i>item3</i>). Specifying host and item patterns is mandatory for "Item patterns" data sets. See also: Data set configuration details.</p> <p>For Item list data set: Select items for the graph by clicking on the <i>Add item</i> button. You may also select compatible widgets as the data source for items by clicking on the <i>Add widget</i> button. Specifying items or widgets is mandatory for "Item list" data sets. See also: Data set configuration details.</p> <p>Note that only numeric item types are allowed.</p>
<p><i>Draw</i></p>	<p>When configuring the widget on a template dashboard, the parameter for specifying host patterns is not available, and the parameter for specifying an item list allows to select only the items configured on the template.</p> <p>Choose the draw type of the metric. Possible draw types: <i>Line</i> (set by default), <i>Points</i>, <i>Staircase</i>, and <i>Bar</i>. Note that if there is only one data point in the line/staircase graph, it is drawn as a point regardless of the draw type. The point size is calculated from the line width, but it cannot be smaller than 3 pixels, even if the line width is less.</p>
<p><i>Stacked</i></p>	<p>Mark the checkbox to display data as stacked (filled areas displayed). This option is disabled when <i>Points</i> draw type is selected.</p>
<p><i>Width</i></p>	<p>Set the line width. This option is available when <i>Line</i> or <i>Staircase</i> draw type is selected.</p>
<p><i>Point size</i></p>	<p>Set the point size. This option is available when <i>Points</i> draw type is selected.</p>
<p><i>Transparency</i></p>	<p>Set the transparency level.</p>
<p><i>Fill</i></p>	<p>Set the fill level. This option is available when <i>Line</i> or <i>Staircase</i> draw type is selected.</p>
<p><i>Missing data</i></p>	<p>Select the option for displaying missing data: None - the gap is left empty; Connected - two border values are connected; Treat as 0 - the missing data is displayed as 0 values; Last known - the missing data is displayed with the same value as the last known value; not applicable for the <i>Points</i> and <i>Bar</i> draw type.</p>
<p><i>Override host</i></p>	<p>Select a compatible widget or the dashboard as the data source for hosts. This parameter is not available when configuring the widget on a template dashboard.</p>
<p><i>Y-axis</i></p>	<p>Select the side of the graph where the Y-axis will be displayed.</p>
<p><i>Time shift</i></p>	<p>Specify time shift if required. You may use time suffixes in this field. Negative values are allowed.</p>
<p><i>Aggregation function</i></p>	<p>Specify which aggregation function to use: min - display the smallest value; max - display the largest value; avg - display the average value; sum - display the sum of values; count - display the count of values; first - display the first value; last - display the last value; none - display all values (no aggregation).</p> <p>Aggregation allows to display an aggregated value for the chosen interval (5 minutes, an hour, a day), instead of all values. See also: Aggregation in graphs.</p>

<i>Aggregation interval</i>	Specify the interval for aggregating values. You may use time suffixes in this field. A numeric value without a suffix will be regarded as seconds.
<i>Aggregate</i>	Specify whether to aggregate: Each item - each item in the dataset will be aggregated and displayed separately; Data set - all dataset items will be aggregated and displayed as one value.
<i>Approximation</i>	Specify what value to display when more than one value exists per vertical graph pixel: all - display the smallest, the largest and the average values; min - display the smallest value; max - display the largest value; avg - display the average value.
<i>Data set label</i>	This setting is useful when displaying a graph for a large time period with frequent update interval (such as one year of values collected every 10 minutes). Specify the data set label that is displayed in graph <i>Data set</i> configuration and in graph <i>Legend</i> (for aggregated data sets). All data sets are numbered including those with a specified <i>Data set label</i> . If no label is specified, the data set will be labeled automatically according to its number (e.g. "Data set #2", "Data set #3", etc.). Data set numbering is recalculated after reordering/dragging data sets. Data set labels that are too long will be shortened to fit where displayed (e.g. "Number of proc...").

Data set configuration details

Existing data sets are displayed in a list. You may:

- Click on the  move icon and drag a data set to a new place in the list.
- Click on the  expand icon to expand data set details. When expanded, this icon turns into a  collapse icon.
- Click on the  color icon to change the color, either from the color picker or manually. For *Item patterns* data set, the color is used to calculate different color shades for each item. For *Item list* data set, the color is used for the specified item.
- Click on the *Add new data set* button to add an empty data set allowing to select host and item patterns. If you click on the downward pointing icon next to the *Add new data set* button, a drop-down menu appears, allowing you to add a new *Item patterns* or *Item list* data set or allowing you to *Clone* the currently open data set. If all data sets are collapsed, the *Clone* option is not available.

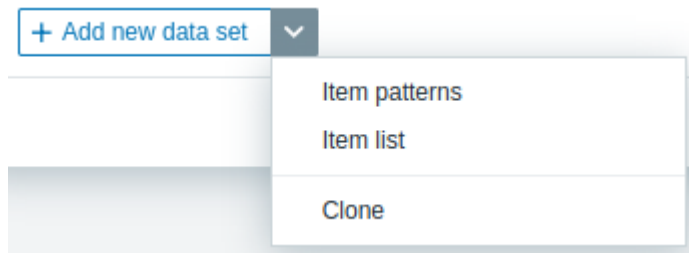

The **Item patterns** data set contains *Host patterns* and *Item patterns* fields that both recognize full names or patterns containing a wildcard symbol (*). This functionality allows you to select all the host names and item names containing the selected pattern. While typing the item name or item pattern in the *Item patterns* field, only items belonging to the selected host name(s) are displayed in the dropdown list.

For example, having typed a pattern **z*** in the *Host patterns* field, the dropdown list displays all host names containing this pattern: **z***, **Zabbix server**, **Zabbix proxy**. After pressing *Enter*, this pattern is accepted and is displayed as **z***. Similarly, having typed the pattern **a*** in the *Item patterns* field, the dropdown list displays all item names containing this pattern: **a***, **Available memory**, **Available memory in %**.

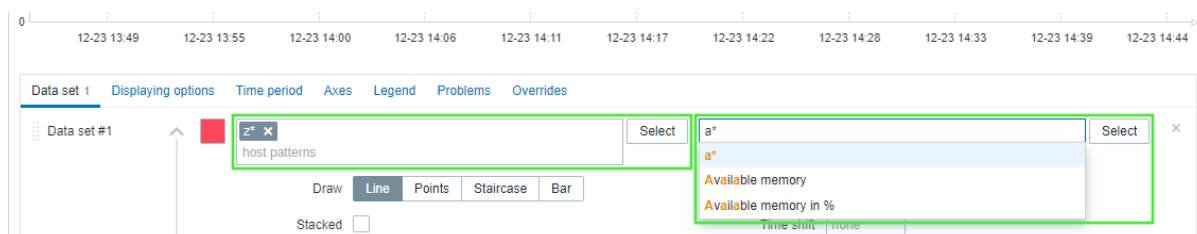

After pressing *Enter*, this pattern is accepted, is displayed as **a***, and all items belonging to the selected host name(s) are displayed in the graph.

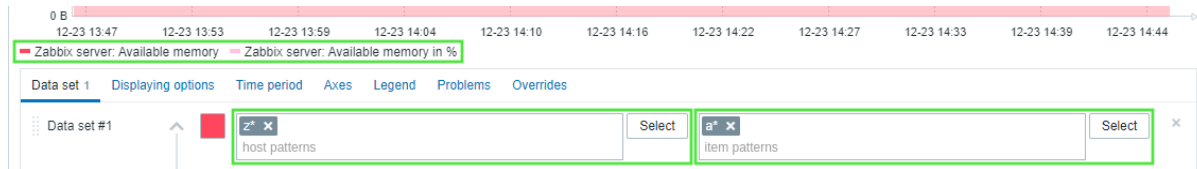

The **Item list** data set contains the *Add item* button that allows you to add items to be displayed on the graph. You can also add compatible widgets as the **data source** for items by clicking the *Add widget* button.

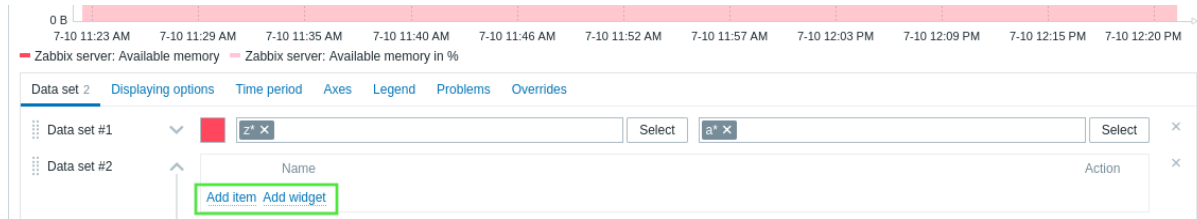

For example, clicking the *Add item* button opens a pop-up window containing a *Host* parameter. Having selected a host, all its items that are available for selection are displayed in a list. After selecting one or more items, they will be displayed in the data set item list and in the graph.

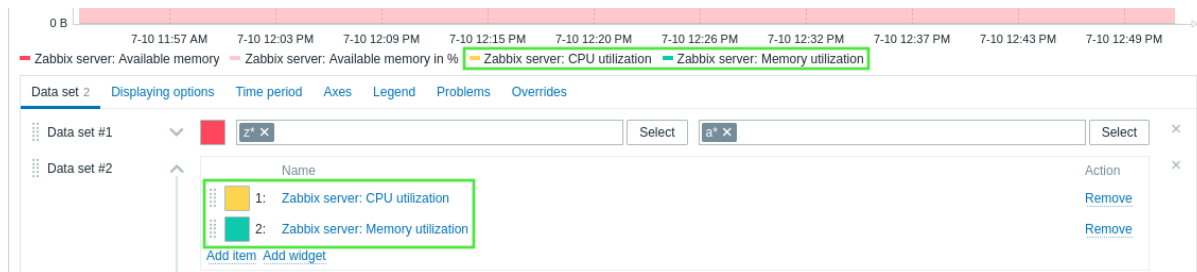

Displaying options

The **Displaying options** tab allows to define history data selection:

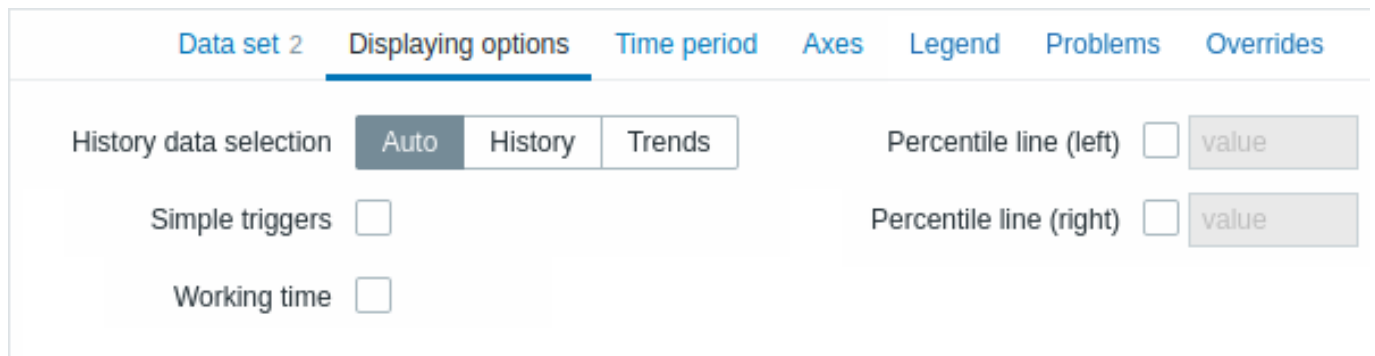

History data selection

Set the source of graph data:

Auto - data are sourced according to the classic graph **algorithm** (default);

History - data from history;

Trends - data from trends.

Simple triggers

Mark the checkbox to show the trigger thresholds for simple triggers. The thresholds will be drawn as dashed lines using the trigger severity color.

A simple trigger is a trigger with one function (only *last*, *max*, *min*, *avg*) for one item in the expression.

A maximum of three triggers can be drawn. Note that the trigger has to be within the drawn range to be visible.

Working time

Mark the checkbox to show working time on the graph. Working time (working days) is displayed in graphs as a white background, while non-working time is displayed in gray (with the *Original blue* default frontend theme).

Percentile line (left)

Mark the checkbox and enter the percentile value to show the specified percentile as a line on the left Y-axis of the graph.

If, for example, a 95% percentile is set, then the percentile line will be at the level where 95 percent of the values fall under.

Percentile line (right) Mark the checkbox and enter the percentile value to show the specified percentile as a line on the right Y-axis of the graph.
If, for example, a 95% percentile is set, then the percentile line will be at the level where 95 percent of the values fall under.

Time period

The **Time period** tab allows to set a time period for which to display data in the graph:

Time period Select the **data source** for the time period:
Dashboard - set the *Time period* selector as the data source;
Widget - set a compatible widget specified in the *Widget* parameter as the data source;
Custom - set the time period specified in the *From* and *To* parameters as the data source; if set, a clock icon will be displayed in the top right corner of the widget, indicating the set time on mouseover.

Widget Enter or select a compatible widget as the data source for the time period.
This parameter is available if *Time period* is set to "Widget".

From Enter or select the start of the time period.
Relative time syntax (`now`, `now/d`, `now/w-1w`, etc.) is supported.
This parameter is available if *Time period* is set to "Custom".

To Enter or select the end of the time period.
Relative time syntax (`now`, `now/d`, `now/w-1w`, etc.) is supported.
This parameter is available if *Time period* is set to "Custom".

Axes

The **Axes** tab allows to customize how axes are displayed:

Left Y Mark this checkbox to make left Y-axis visible.
The checkbox may be disabled if unselected either in *Data set* or in *Overrides* tab.

Right Y Mark this checkbox to make right Y-axis visible.
The checkbox may be disabled if unselected either in *Data set* or in *Overrides* tab.

X-Axis Unmark this checkbox to hide X-axis (marked by default).

Scale Choose the scale for the graph axis values from the dropdown:
Linear - axis values increase by a fixed amount (e.g., 10, 20, 30), suitable for data that changes steadily or covers a small to moderate range;
Logarithmic - axis values increase exponentially (e.g., 10, 100, 1000), suitable for data that changes rapidly or covers a large range.

Min Set the minimum value of the corresponding axis.
Visible range minimum value of Y-axis is specified.

Max Set the maximum value of the corresponding axis.
Visible range maximum value of Y-axis is specified.

Units Choose the unit for the graph axis values from the dropdown:
Auto - axis values are displayed using the unit of the first item in the data set;
Static - axis values are displayed using the unit specified in the *value* input field; if the field is left blank, only numeric values are displayed.

Legend

The **Legend** tab allows to customize the graph legend:

Show legend Unmark this checkbox to hide the legend on the graph (marked by default).
Display min/avg/max Mark this checkbox to display the minimum, average, and maximum values of the item in the legend.
Show aggregation function Mark this checkbox to show the aggregation function in the legend.
Rows Select the display mode for legend rows:
Fixed - the number of rows displayed is determined by the *Number of rows* parameter value;
Variable - the number of rows displayed is determined by the amount of configured items while not exceeding the *Maximum number of rows* parameter value.
Number of rows/ Maximum number of rows If *Rows* is set to "Fixed", set the number of legend rows to be displayed (1-10).
 If *Rows* is set to "Variable", set the maximum number of legend rows to be displayed (1-10).
Number of columns Set the number of legend columns to be displayed (1-4).
 This parameter is available if *Display min/avg/max* is unmarked.

Problems

The **Problems** tab allows to customize the problem display:

Show problems Mark this checkbox to enable problem displaying on the graph (unmarked, i.e., disabled by default).
Selected items only Mark this checkbox to include problems for the selected items only to be displayed on the graph.

Problem hosts

Select the problem hosts to be displayed on the graph.

Wildcard patterns may be used (for example, * will return results that match zero or more characters).

To specify a wildcard pattern, just enter the string manually and press *Enter*.

While you are typing, note how all matching hosts are displayed in the dropdown.

Severity

This parameter is not available when configuring the widget on a **template dashboard**.

Mark problem severities to filter problems to be displayed on the graph.

If no severities are marked, all problems will be displayed.

Problem

Specify the problem's name to be displayed on the graph.

Problem tags

Specify problem tags to limit the number of problems displayed in the widget.

It is possible to include as well as exclude specific tags and tag values. Several conditions can be set. Tag name matching is always case-sensitive.

There are several operators available for each condition:

Exists - include the specified tag names;

Equals - include the specified tag names and values (case-sensitive);

Contains - include the specified tag names where the tag values contain the entered string (substring match, case-insensitive);

Does not exist - exclude the specified tag names;

Does not equal - exclude the specified tag names and values (case-sensitive);

Does not contain - exclude the specified tag names where the tag values contain the entered string (substring match, case-insensitive).

There are two calculation types for conditions:

And/Or - all conditions must be met, conditions having the same tag name will be grouped by the *Or* condition;

Or - enough if one condition is met.

Overrides

The **Overrides** tab allows to add custom overrides for data sets:

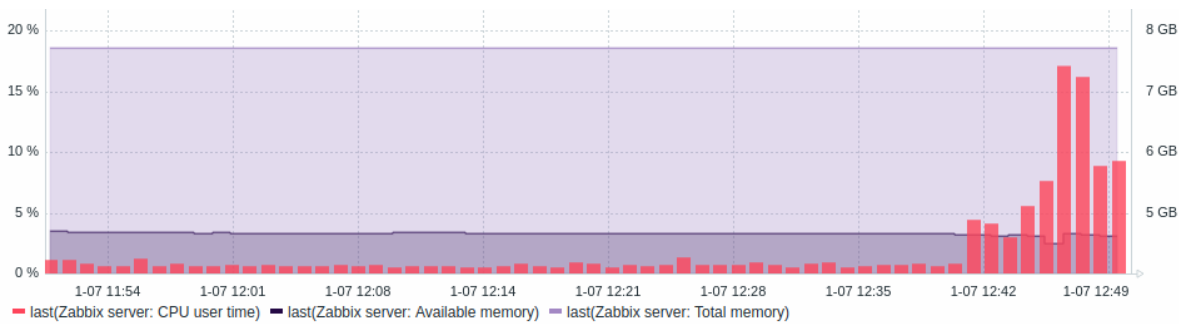

Overrides 1

Zabbix* x Select *memory x Select x

host patterns item patterns

250A46 x Draw: Staircase x Transparency: 0 x +

+ Add new override

Overrides are useful when several items are selected for a data set using the * wildcard and you want to change how the items are displayed by default (e.g. default base color or any other property).

Existing overrides (if any) are displayed in a list. To add a new override:



- Click on the  button
- Select hosts and items for the override. Alternatively, you may enter host and item patterns. Wildcard patterns may be used (for example, * will return results that match zero or more characters). To specify a wildcard pattern, just enter the string manually and press *Enter*. While you are typing, note how all matching hosts are displayed in the dropdown. The wildcard symbol is always interpreted, therefore it is not possible to add, for example, an item named "item*" individually if there

are other matching items (e.g. item2, item3). Host pattern and item pattern parameters are mandatory. The parameter for specifying host patterns is not available when configuring the widget on a **template dashboard**. The parameter for specifying an item list allows to select only **items configured on the template** when configuring the widget on a **template dashboard**.



- Click on , to select override parameters. At least one override parameter should be selected. For parameter descriptions, see the *Data set* tab above.

Information displayed by the graph widget can be downloaded as a .png image using the **widget menu**:

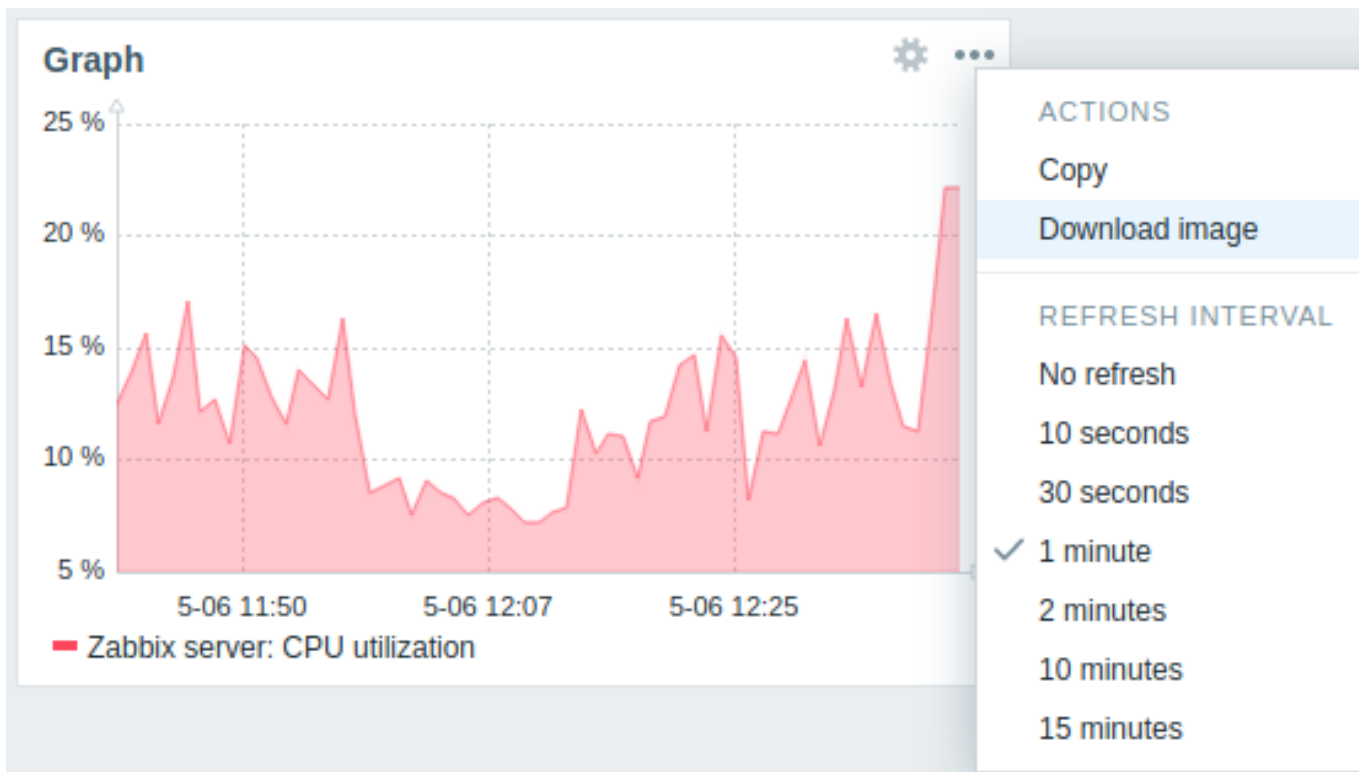

A screenshot of the widget will be saved to the Downloads folder.

9 Graph (classic)

Overview

In the classic graph widget, you can display a single custom graph or simple graph.

Configuration

To configure, select *Graph (classic)* as type:

Add widget ? X

Type: Graph (classic) ▼ Show header

Name:

Refresh interval: Default (1 minute) ▼

Source: Graph Simple graph

* Graph: Select ▼

Time period: Dashboard Widget Custom

Show legend:

Override host: Select ▼

Add Cancel

In addition to the parameters that are **common** for all widgets, you may set the following specific options:

<i>Source</i>	Select the graph type: Graph - custom graph ; Simple graph - simple graph .
<i>Graph</i>	Select the custom graph to display. Alternatively, select a compatible widget as the data source for graphs.
<i>Item</i>	This parameter is available if <i>Source</i> is set to "Graph". Select the item to display in a simple graph. Alternatively, select a compatible widget as the data source for items.
<i>Time period</i>	This parameter is available if <i>Source</i> is set to "Simple graph". Set a time period for which to display data in the graph. Select the data source for the time period: Dashboard - set the <i>Time period</i> selector as the data source; Widget - set a compatible widget specified in the <i>Widget</i> parameter as the data source; Custom - set the time period specified in the <i>From</i> and <i>To</i> parameters as the data source; if set, a clock icon will be displayed in the top right corner of the widget, indicating the set time on mouseover.
<i>Widget</i>	Enter or select a compatible widget as the data source for the time period. This parameter is available if <i>Time period</i> is set to "Widget".
<i>From</i>	Enter or select the start of the time period. Relative time syntax (<code>now</code> , <code>now/d</code> , <code>now/w-1w</code> , etc.) is supported.
<i>To</i>	This parameter is available if <i>Time period</i> is set to "Custom". Enter or select the end of the time period. Relative time syntax (<code>now</code> , <code>now/d</code> , <code>now/w-1w</code> , etc.) is supported.
<i>Show legend</i>	This parameter is available if <i>Time period</i> is set to "Custom". Unmark this checkbox to hide the legend on the graph (marked by default).
<i>Override host</i>	Select a compatible widget or the dashboard as the data source for hosts. This parameter is not available when configuring the widget on a template dashboard .

Information displayed by the classic graph widget can be downloaded as *.png* image using the **widget menu**:

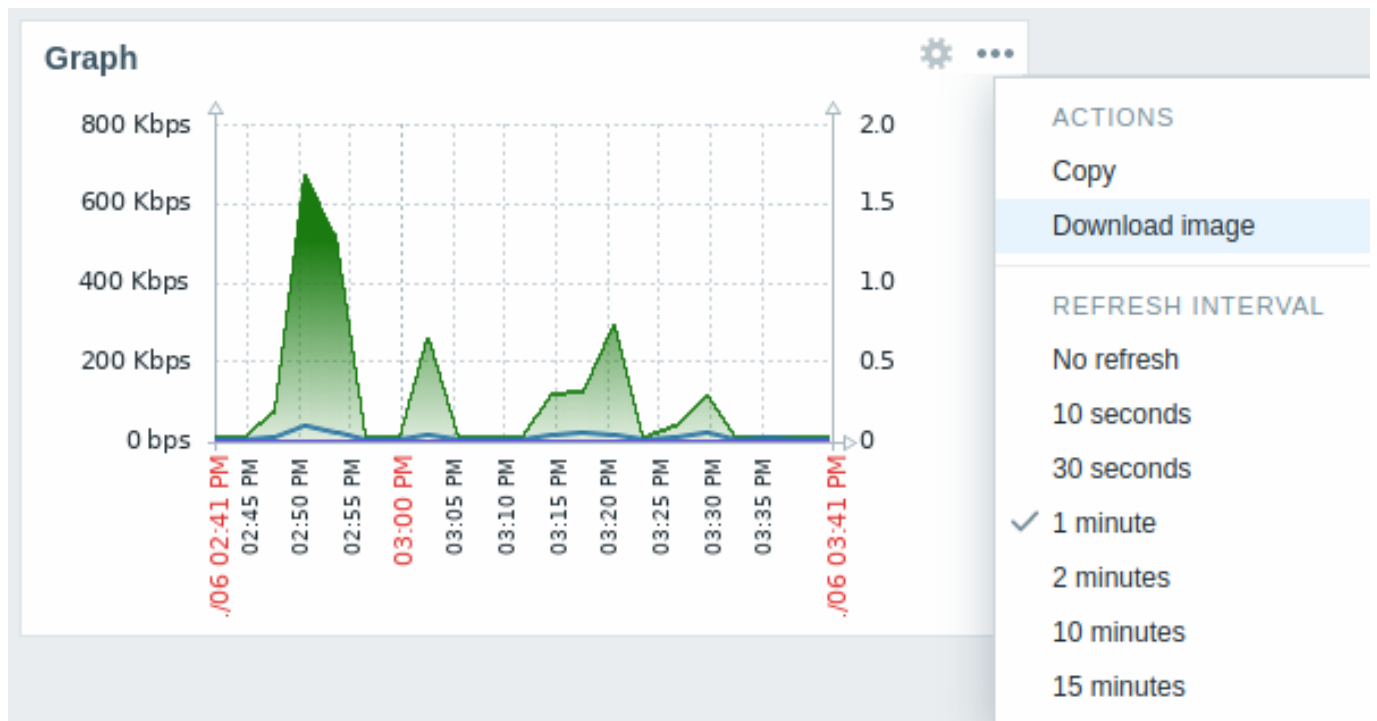

A screenshot of the widget will be saved to the *Downloads* folder.

10 Graph prototype

Overview

In the graph prototype widget, you can display a grid of graphs created from either a graph prototype or an item prototype by low-level discovery.

Configuration

To configure, select *Graph prototype* as widget type:

In addition to the parameters that are **common** for all widgets, you may set the following specific options:

<i>Source</i>	Select the source of the graphs: Graph prototype or Simple graph prototype .
<i>Graph prototype</i>	Select a graph prototype to display graphs discovered by the graph prototype. This parameter is available if <i>Source</i> is set to "Graph prototype".
<i>Item prototype</i>	Select an item prototype to display simple graphs for items discovered by the item prototype. This parameter is available if <i>Source</i> is set to "Simple graph prototype".
<i>Time period</i>	Set a time period for which to display data in the graphs. Select the data source for the time period: Dashboard - set the <i>Time period</i> selector as the data source; Widget - set a compatible widget specified in the <i>Widget</i> parameter as the data source; Custom - set the time period specified in the <i>From</i> and <i>To</i> parameters as the data source; if set, a clock icon will be displayed in the top right corner of the widget, indicating the set time on mouseover.
<i>Widget</i>	Enter or select a compatible widget as the data source for the time period. This parameter is available if <i>Time period</i> is set to "Widget".
<i>From</i>	Enter or select the start of the time period. Relative time syntax (now, now/d, now/w-1w, etc.) is supported. This parameter is available if <i>Time period</i> is set to "Custom".
<i>To</i>	Enter or select the end of the time period. Relative time syntax (now, now/d, now/w-1w, etc.) is supported. This parameter is available if <i>Time period</i> is set to "Custom".
<i>Show legend</i>	Unmark this checkbox to hide the legend on the graphs (marked by default).
<i>Override host</i>	Select a compatible widget or the dashboard as the data source for hosts. This parameter is not available when configuring the widget on a template dashboard .
<i>Columns</i>	Enter the number of columns of graphs to display within a graph prototype widget.
<i>Rows</i>	Enter the number of rows of graphs to display within a graph prototype widget.

While the *Columns* and *Rows* parameters allow fitting more than one graph in the widget, there still may be more discovered graphs

than there are columns/rows in the widget. In this case, paging becomes available in the widget, and a slide-up header allows to switch between pages using the left and right arrows:

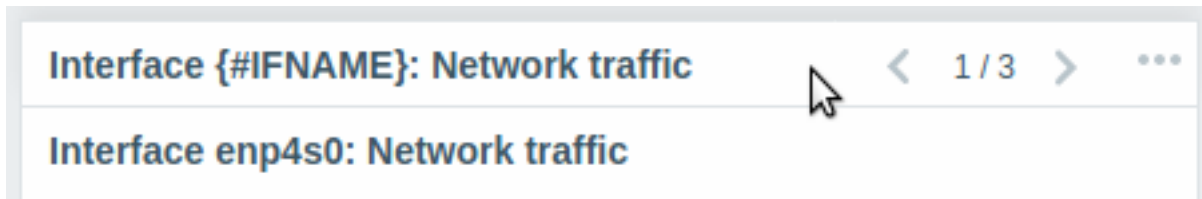

11 Honeycomb

Overview

The honeycomb widget offers a dynamic overview of the monitored network infrastructure and resources, where host groups, such as virtual machines and network devices, along with their respective items, are visually represented as interactive hexagonal cells.



The widget can be visually fine-tuned using the [advanced configuration](#) options to create a wide variety of visual styles.

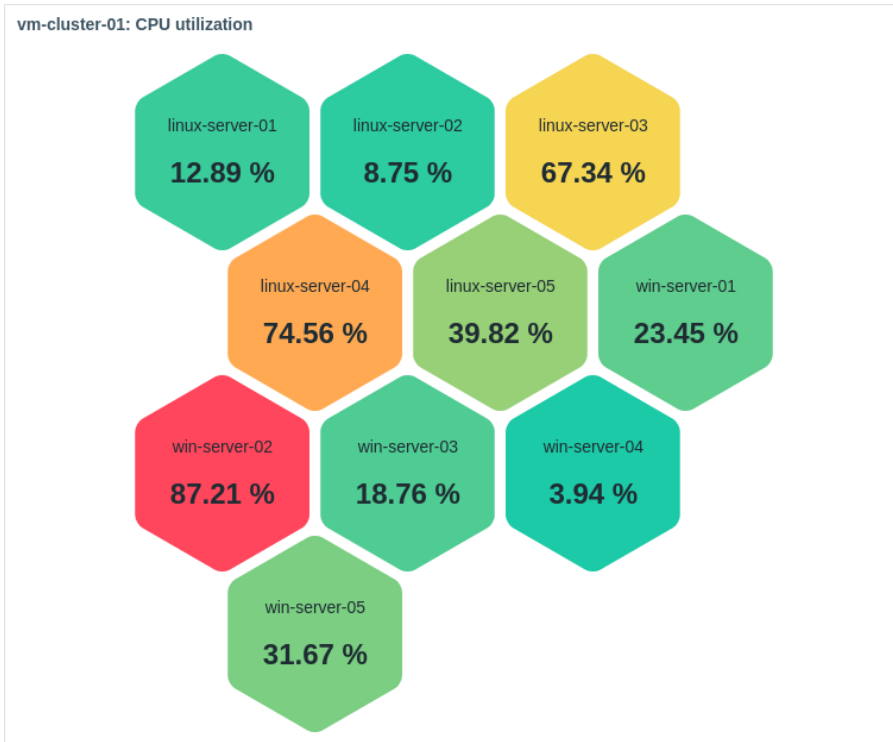

On mouseover, the focused honeycomb cell enlarges for improved visibility. Clicking a cell highlights its border until another cell is selected.

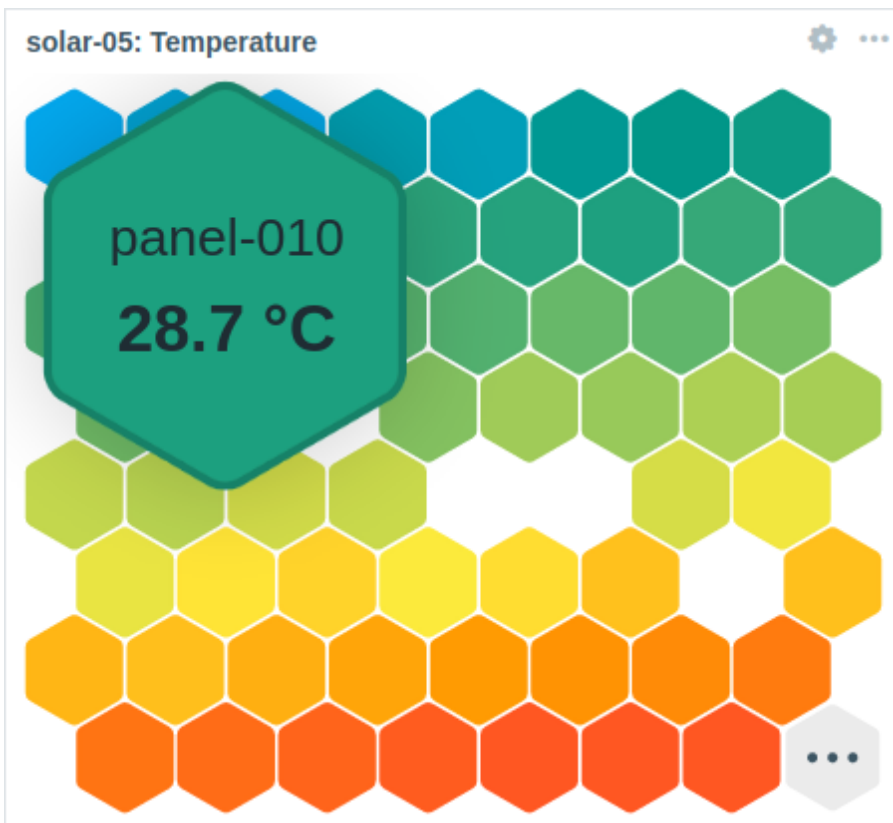

The number of displayed honeycomb cells is constrained by the widget's size and the minimum cell size (32 pixels). If all cells cannot fit within the widget, an ellipsis is shown as the final cell.

The widget can be resized to fit more cells. On resize, the honeycomb cell size and positioning are dynamically adjusted. Each row in the honeycomb will maintain an equal cell count, except for the last row if the total cell count is not divisible by the row's cell count.

Configuration

To configure, select *Honeycomb* as type:

Add widget
? X

Type

Name

Refresh interval

Host groups

Hosts

Host tags

[Add](#)

Show header

* Item patterns

Item tags

[Add](#)

Show hosts in maintenance

* Show Primary label Secondary label

[Advanced configuration](#)

In addition to the parameters that are **common** for all widgets, you may set the following specific options:

<i>Host groups</i>	<p>Select host groups.</p> <p>Alternatively, select a compatible widget as the data source for host groups.</p> <p>This field is auto-complete, so starting to type the name of a group will offer a dropdown of matching groups.</p> <p>Selecting a parent host group implicitly selects all nested host groups; if no host groups are selected, the widget will display all host groups containing hosts with items matching the selected <i>Item pattern</i> (see below).</p> <p>This parameter is not available when configuring the widget on a template dashboard.</p>
<i>Hosts</i>	<p>Select hosts.</p> <p>Alternatively, select a compatible widget or the dashboard as the data source for hosts.</p> <p>This field is auto-complete, so starting to type the name of a host will offer a dropdown of matching hosts.</p> <p>If no hosts are selected, the widget will display all hosts with items matching the selected <i>Item pattern</i> (see below).</p> <p>This parameter is not available when configuring the widget on a template dashboard.</p>

<i>Host tags</i>	<p>Specify tags to limit the number of hosts displayed in the widget. It is possible to include as well as exclude specific tags and tag values. Several conditions can be set. Tag name matching is always case-sensitive.</p> <p>There are several operators available for each condition: Exists - include the specified tag names; Equals - include the specified tag names and values (case-sensitive); Contains - include the specified tag names where the tag values contain the entered string (substring match, case-insensitive); Does not exist - exclude the specified tag names; Does not equal - exclude the specified tag names and values (case-sensitive); Does not contain - exclude the specified tag names where the tag values contain the entered string (substring match, case-insensitive).</p> <p>There are two calculation types for conditions: And/Or - all conditions must be met, conditions having the same tag name will be grouped by the Or condition; Or - enough if one condition is met.</p>
<i>Item patterns</i>	<p>This parameter is not available when configuring the widget on a template dashboard. Enter item patterns or select existing items as item patterns. Data of items that match the entered or selected patterns will be displayed on the honeycomb. The <i>Item patterns</i> parameter is mandatory.</p> <p>Wildcard patterns may be used for selection (for example, * will return items that match zero or more characters; Zabbix* will return items that start with "Zabbix"). To specify a wildcard pattern, enter the string manually and press <i>Enter</i>. When you start typing, a dropdown list will show matching items limited to those belonging to selected <i>Hosts</i> or hosts within selected <i>Host groups</i>, if any. The wildcard symbol is always interpreted, therefore, it is not possible to add, for example, an item named <i>item*</i> individually, if there are other matching items (e.g., item2, item3).</p> <p>When configuring the widget on a template dashboard, this parameter allows selecting only items configured on the template.</p>
<i>Item tags</i>	Specify tags to limit the number of items displayed in the widget. For more information, see <i>Host tags</i> above.
<i>Show hosts in maintenance</i>	<p>Mark this checkbox to display hosts in maintenance (in this case, maintenance icon will be shown next to the host name). This parameter is labeled <i>Show data in maintenance</i> when configuring the widget on a template dashboard.</p>
<i>Show</i>	<p>Mark this checkbox to display the respective honeycomb cell element - primary label, secondary label. At least one element must be selected.</p>
<i>Advanced configuration</i>	Click the <i>Advanced configuration</i> label to display advanced configuration options.

Advanced configuration

Advanced configuration options are available in the collapsible *Advanced configuration* section and only for elements selected in the *Show* field (see above) and the background color or thresholds for honeycomb cells.

Advanced configuration

Primary label

Type Text Value

* Text ?

Size Auto Custom Bold

Color

Secondary label

Type Text Value

Decimal places

Size Auto Custom Bold

Color

Units Position

Background color

Thresholds Color interpolation

Threshold	Action
<input type="text" value="80"/>	Remove
<input type="text" value="65"/>	Remove
<input type="text" value="0"/>	Remove

[Add](#)

Primary/Secondary label

Type

Select the label type:

Text - the label will display the text specified in the *Text* parameter;

Value - the label will display the item value with decimal places as specified in the *Decimal places* parameter.

Text

Enter the label text. This text may override the default item name.

Multiline text is supported. A combination of text and **supported macros** is possible.

{HOST.*}, {ITEM.*}, {INVENTORY.*}, and **user macros** are supported.

Honeycomb cells are ordered alphabetically by host name, and, within each host, by item name.

This parameter is available if *Type* is set to "Text".

Decimal places

Enter the number of decimal places to display with the value.

This parameter is available if *Type* is set to "Value", and affects only items that return **numeric (float)** data.

Size

Select the label size:

Auto - use automatically adjusted label size;

Custom - enter a custom label size (in percent, relative to the honeycomb cell size).

Note that labels that do not fit the honeycomb cell size are truncated.

Bold

Mark the checkbox to display item units in bold.

Color

Select the item units color from the color picker.

"D" stands for the default color, which depends on the frontend theme. To return to the default color, click the *Use default* button in the color picker.

Units

Units

Mark the checkbox to display units with the item value.

If you enter a unit name, it will override the units set in the **item configuration**.

This parameter is available if *Type* is set to "Text".

Position

Select the position of the item units (before or after the item value).

This parameter is ignored for the following **time-related units**: unixtime, uptime, s.

This parameter is available if *Type* is set to "Text".

Background color

Background color

Select the honeycomb cells background color from the color picker.

"D" stands for the default color, which depends on the frontend theme. To return to the default color, click the *Use default* button in the color picker.

Thresholds

Color interpolation

Mark the checkbox to enable smooth transitioning between threshold colors for honeycomb cells. This parameter is available if two or more thresholds are set.

Threshold

Click *Add* to add a threshold, select a threshold color from the color picker, and specify a numeric value.

The thresholds list will be sorted in ascending order when saved.

Note that the colors configured as thresholds will be displayed correctly only for numeric items.

Suffixes (for example, "1d", "2w", "4K", "8G") are supported. **Value mappings** are supported.

The information displayed by the honeycomb widget can be downloaded as a *.png* image using the **widget menu**:

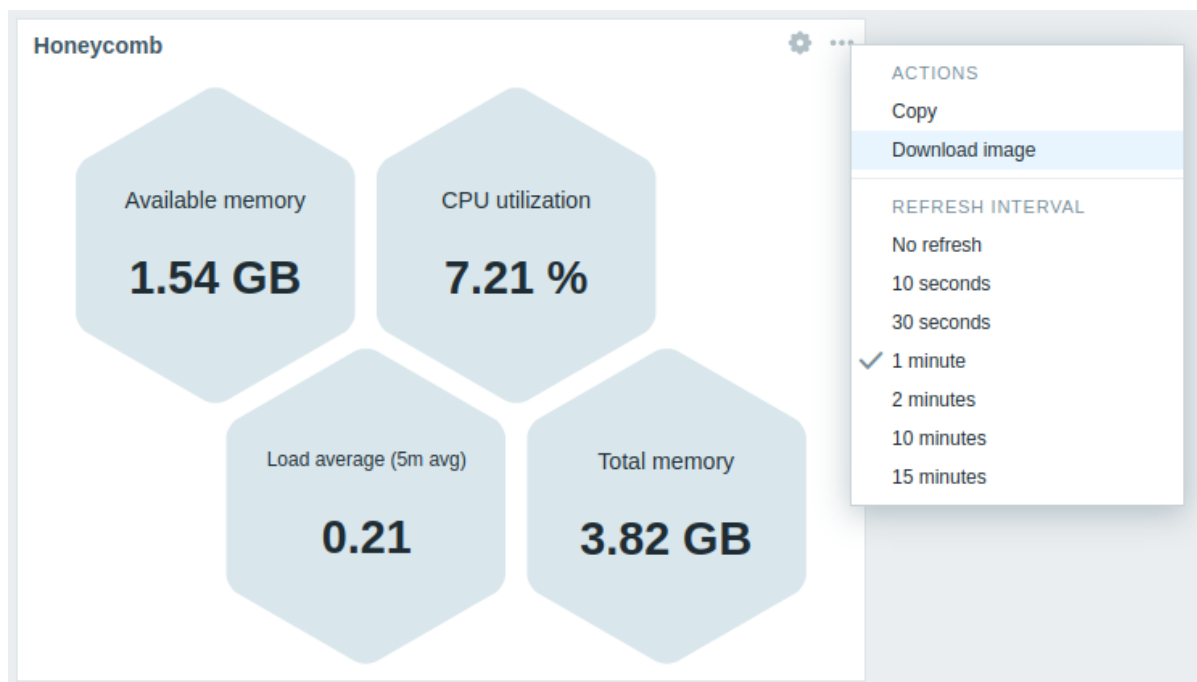

A screenshot of the widget will be saved to the *Downloads* folder.

12 Host availability

Overview

In the host availability widget, high-level statistics about host availability are displayed in colored columns/lines, depending on the chosen layout.

Horizontal display (columns):

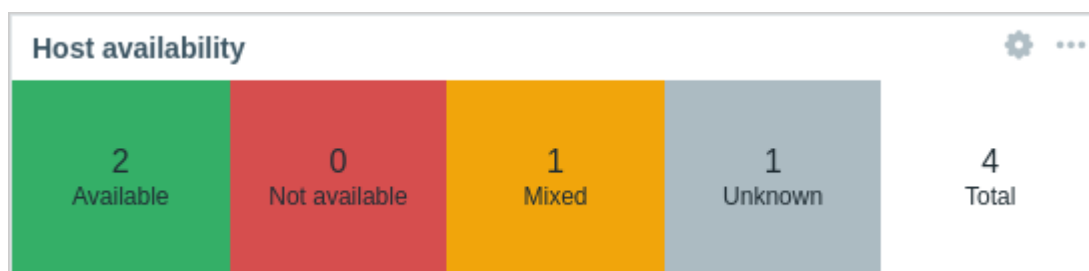

Vertical display (lines):



Host availability in each column/line is counted as follows:

- *Available* - hosts with all interfaces available
- *Not available* - hosts with all interfaces not available
- *Mixed* - hosts with at least one interface unavailable and at least one either available or unknown; others can have any value, including "unknown"
- *Unknown* - hosts with at least one interface unknown (none unavailable)
- *Total* - total of all hosts

Note:

For Zabbix agent (active checks), the *Mixed* cell will always be empty since this type of items cannot have multiple interfaces.

Configuration

To configure, select *Host availability* as type:

Add widget ? X

Type: Host availability Show header

Name:

Refresh interval: Default (15 minutes)

Host groups: Select ▼

Interface type: Zabbix agent (active checks)
 Zabbix agent (passive checks)
 SNMP
 JMX
 IPMI

Layout: Horizontal Vertical

Include hosts in maintenance:

Show only totals:

Add Cancel

In addition to the parameters that are **common** for all widgets, you may set the following specific options:

<i>Host groups</i>	Select host groups. Alternatively, select a compatible widget as the data source for host groups. This field is auto-complete, so starting to type the name of a group will offer a dropdown of matching groups. This parameter is not available when configuring the widget on a template dashboard .
<i>Interface type</i>	Select which host interfaces you want to see availability data for. Availability of all interfaces is displayed by default if nothing is selected.
<i>Layout</i>	Select horizontal display (columns) or vertical display (lines).
<i>Include hosts in maintenance</i>	Include hosts that are in maintenance in the statistics. This parameter is labeled <i>Show data in maintenance</i> when configuring the widget on a template dashboard .
<i>Show only totals</i>	If checked, the total of hosts, without breakdown by interfaces, is displayed. This option is disabled if only one interface is selected.

13 Host card

Overview

The Host card widget provides comprehensive and customizable information about a single host. The host can be specified through the widget configuration, selected from another compatible widget, or located using the host selector at the dashboard level.

Server database		1 1 5		
Monitoring	Dashboards	1	Graphs	6
	Latest data	51	Web	0
Availability		ZBX		
Monitored by		Zabbix server		
class: database		location: new-york target: mysql		
Host groups		Databases		
Templates		MySQL by Zabbix agent		
Inventory				
Contact				
Primary POC e...		admin@company.com		

Top part of the widget contains the name of a host and the number of host problems grouped by severity. If a host is disabled, the text *Disabled* will be written next to the host name. If a host is in maintenance, the maintenance icon will be displayed next to the host name. Other sections of the widget can be customized as required.

This widget automatically adjusts the layout based on the width. To rearrange widget sections into multiple columns, expand the widget horizontally.

Configuration

To configure, select *Host card* as type:

In addition to the parameters that are **common** for all widgets, you may set the following specific parameters:

<i>Host</i>	Select the host. Alternatively, select a compatible widget or the dashboard as the data source . This field provides matching suggestions as you start typing a name. You can also press the Select button to choose manually.
<i>Show suppressed problems</i>	This parameter is not available when configuring the widget on a template dashboard . Mark this checkbox to include suppressed problems into problem calculation.
<i>Show</i>	Configure up to eight sections to be displayed by the widget. The sections can be rearranged by dragging and dropping.
<i>Host groups</i>	Host groups the host belongs to.
<i>Description</i>	Host description.
<i>Monitoring</i>	Quick links for navigating to dashboards, latest data, graphs, and web scenarios of the host. The number next to each link indicates the number of entities.
<i>Availability</i>	Host availability by interface.
<i>Monitored by</i>	Zabbix server, proxy, or proxy group the host is monitored by.
<i>Templates</i>	Templates linked to the host.
<i>Inventory</i>	Display host inventory fields. If selected, an <i>Inventory fields</i> parameter will appear, allowing to specify which fields should be displayed.
<i>Tags</i>	Host tags.

Inventory fields

Specify the inventory fields to be displayed.
This field provides matching suggestions as you start typing a name. Alternatively, you can press the Select button to choose manually.
If no inventory fields are specified, all populated inventory fields will be displayed.

This parameter becomes available only when *Inventory* is selected in the *Show* section.

14 Host navigator

Overview

The host navigator widget displays hosts based on various filtering and grouping options.

Host navigator	
▼ Linux servers	2 5
▼ Riga	2 5
▼ High	2
linux-server-01	2 3
▼ Warning	5
linux-server-01	2 3
linux-server-02	2
▼ Uncategorized	
linux-server-03	
▶ Tokyo	
▼ Zabbix servers	1
▼ Riga	1
▼ Information	1
zbx-Riga	1
▼ Tokyo	
▼ Uncategorized	
zbx-Tokyo	

The widget also allows to control the information displayed in other widgets based on the selected host.

Host navigator

- ▼ Linux servers 2 5
- ▼ Riga 2 5
- ▼ High 2
- linux-server-01 2 3
- ▼ Warning 5
- linux-server-01 2 3
- linux-server-02 2
- ▶ *Uncategorized*
- ▶ Tokyo
- ▶ Zabbix servers 1

linux-server-01: CPU utilization

92.18%

linux-server-01: Available memory

1.62 GB ↓

Groups by which hosts are organized can be expanded or collapsed.

For groups, problems, and hosts in maintenance, additional details are accessible by mouseover hints.

Configuration

To configure, select *Host navigator* as type:

Add widget
? X

Type

Name

Refresh interval

Host groups

Host patterns

Host status Any Enabled Disabled

Host tags And/Or Or

[Add](#)

Severity Not classified Warning High
 Information Average Disaster

Show hosts in maintenance

Show problems

Group by

1:

2:

3:

[Add](#)

* Host limit

Show header

In addition to the parameters that are **common** for all widgets, you may set the following specific options:

-
- | | |
|----------------------|---|
| <i>Host groups</i> | <p>Select host groups.
Alternatively, select a compatible widget as the data source for host groups.
This field is auto-complete, so starting to type the name of a group will offer a dropdown of matching groups.
Selecting a parent host group implicitly selects all nested host groups; if no host groups are selected, the widget will display all hosts from all host groups.</p> <p>This parameter is not available when configuring the widget on a template dashboard.</p> |
| <i>Host patterns</i> | <p>Enter host patterns or select existing hosts as host patterns. Hosts that match the specified patterns will be displayed on the host navigator.
This field is auto-complete, so starting to type the name of a host will offer a dropdown of matching hosts.
If no hosts are selected, the widget will display all hosts.</p> <p>Wildcard patterns may be used for selection (for example, * will return hosts that match zero or more characters; Zabbix* will return hosts that start with "Zabbix").
To specify a wildcard pattern, enter the string manually and press <i>Enter</i>. When you start typing, a dropdown list will show matching hosts limited to those belonging to hosts within selected <i>Host groups</i>, if any.</p> |
| <i>Host status</i> | <p>This parameter is not available when configuring the widget on a template dashboard.
Filter which hosts to display based on their status (any, enabled, disabled).</p> <p>This parameter is not available when configuring the widget on a template dashboard.</p> |

<i>Host tags</i>	<p>Specify tags to filter the hosts displayed in the widget. It is possible to include as well as exclude specific tags and tag values. Several conditions can be set. Tag name matching is always case-sensitive.</p> <p>There are several operators available for each condition: Exists - include the specified tag names; Equals - include the specified tag names and values (case-sensitive); Contains - include the specified tag names where the tag values contain the entered string (substring match, case-insensitive); Does not exist - exclude the specified tag names; Does not equal - exclude the specified tag names and values (case-sensitive); Does not contain - exclude the specified tag names where the tag values contain the entered string (substring match, case-insensitive).</p> <p>There are two calculation types for conditions: And/Or - all conditions must be met, conditions having the same tag name will be grouped by the Or condition; Or - enough if one condition is met.</p>
<i>Severity</i>	<p>This parameter is not available when configuring the widget on a template dashboard. Mark problem severities to filter hosts with problems to be displayed in the widget. If no severities are marked, all hosts with all problems will be displayed.</p>
<i>Show hosts in maintenance</i>	<p>Mark this checkbox to display hosts in maintenance (in this case, maintenance icon will be shown next to the host name).</p>
<i>Show problems</i>	<p>This parameter is labeled <i>Show data in maintenance</i> when configuring the widget on a template dashboard. Filter which problems to display with the hosts in the widget based on their status (all, unsuppressed, none).</p>
<i>Group by</i>	<p>Add a grouping attribute by which to group the selected hosts: Host group - group hosts by their host group; Tag value - enter a tag name to group hosts by the values of this tag (for example, enter "city" to group hosts by values "Riga", "Tokyo", etc.); Severity - group hosts by their problem severities.</p> <p>If <i>Show problems</i> is configured to display problems, they are displayed as follows: - for each severity group, only the corresponding problem count is displayed; - for each host, all its problem counts are displayed. Note that hosts will be grouped only by those severities marked in the <i>Severity</i> parameter; if no severities are marked, all hosts will be grouped by all severities.</p> <p>Grouping attributes can be reordered by dragging up or down by the handle before the group name. Note that grouping attribute order determines group nesting order. For example, specifying multiple tag names (1: color, 2: city) will result in hosts being grouped by color (red, blue, etc.) and then by city (Riga, Tokyo, etc.).</p> <p>A host may be displayed in multiple groups depending on the configured grouping attributes (for example, when grouping by host group and the host belongs to multiple host groups). Clicking such hosts selects and highlights them in all groups. Hosts that do not match the configured grouping attributes are displayed in the <i>Uncategorized</i> group.</p> <p>Up to 10 grouping attributes can be specified, and all must be unique. If no grouping attributes are specified, hosts will not be grouped.</p>

Host limit

Enter the maximum number of hosts to be displayed. Possible values range from 1-9999.

When more hosts are available for displaying than the set limit, a corresponding message is shown below the displayed hosts (for example, "100 of 100+ hosts are shown"). Note that the configured host limit also affects the display of configured groups; for example, if host limit is set to 100 and hosts are grouped by tag values (more than 200), only the first 100 tag values with the corresponding hosts will be displayed in the widget.



This parameter is not affected by the *Limit for search and filter results* parameter in *Administration → General → GUI*.

This parameter is not available when configuring the widget on a **template dashboard**.

15 Item history

Overview

The item history widget displays the latest data for various item types (numeric, character, log, text, and binary) in a table format. It can also show progress bars, images for binary data types (useful for **browser items**), and highlight values (useful for **log file monitoring**).

Zabbix server		
Timestamp	Name	Value
2024-05-30 01:54:24 PM	CPU utilization	 100 %
2024-05-30 01:54:04 PM	Memory utilization	 57.6091 %
2024-05-30 01:53:57 PM	Number of processed values per second	22.115
2024-05-30 01:53:24 PM	CPU utilization	 100 %

zabbix_agentd.log	
7438:20240530:135401.322	zbx_setproctitle() title:'listener #1 [waiting for connection]'
8211:20240530:135401.321	zbx_popen(): executing script
7446:20240530:135401.320	zbx_setproctitle() title:'listener #9 [waiting for connection]'
7446:20240530:135401.320	Sending back [{"version":"7.0.0rc3","variant":1,"data":{"error":"Accessible only as active check."}}]
7446:20240530:135401.320	Requested [{"request":"passive checks","data":{"key":"log[/tmp/zabbix_server.log,,,skip]","timeout":4}}]
7446:20240530:135401.320	zbx_setproctitle() title:'listener #9 [processing request]'

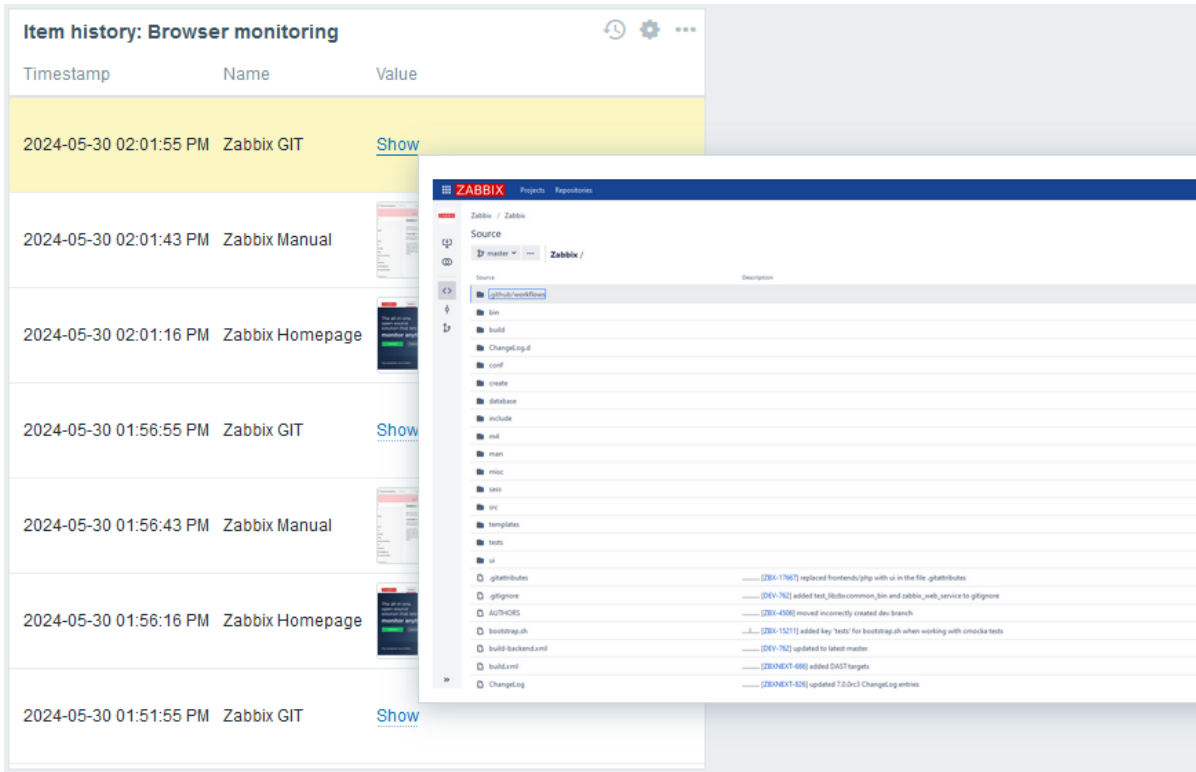

Up to 1000 records can be displayed.

Configuration

To configure, select *Item history* as type:

Add widget ? X

Type: Item history Show header

Name:

Refresh interval: Default (1 minute)

Layout: Horizontal Vertical

* Items

Name	Item	Actions
CPU utilization	Zabbix server: CPU utilization	Edit Remove
Memory utilization	Zabbix server: Memory utilization	Edit Remove

[Add](#)

* Show lines:

Override host: Select

[Advanced configuration](#)

Add Cancel

In addition to the parameters that are **common** for all widgets, you may set the following specific options:

Layout

Select the layout option for item columns:
Horizontal - items will be displayed horizontally, values vertically;
Vertical - items will be displayed vertically, values horizontally.

Items

Add item **columns** to display.
 The order of items determines their display order.
 Items can be reordered by dragging them up or down by the handle before the item name.

<i>Show lines</i>	Specify the number of item value lines to display.
<i>Override host</i>	Select a compatible widget or the dashboard as the data source for hosts. This parameter is not available when configuring the widget on a template dashboard .
<i>Advanced configuration</i>	Click the <i>Advanced configuration</i> label to display advanced configuration options.

Column configuration

To configure item columns, click *Add* in the *Items* parameter:

The screenshot shows a 'New column' configuration window. It includes the following elements:

- Name:** CPU utilization
- Item:** Zabbix server: CPU utilization (with a 'Select' button)
- Base color:** A color picker showing red.
- Display:** Radio buttons for 'As is', 'Bar' (selected), and 'Indicators'.
- Min:** calculated
- Max:** calculated
- Thresholds:** A table with three rows:

Threshold	Action
80 (with red color swatch)	Remove
50 (with yellow color swatch)	Remove
0 (with green color swatch)	Remove

 An 'Add' button is located below the table.
- History data:** Radio buttons for 'Auto' (selected), 'History', and 'Trends'.
- Buttons:** 'Add' and 'Cancel' at the bottom right.

Common column parameters:

<i>Name</i>	Enter the name of the column. If left empty, the item name from the <i>Item</i> parameter is used.
<i>Item</i>	Select the item. Note that column configuration parameters vary based on the information type of the selected item; for more information, see individual parameters below. When configuring the widget on a template dashboard , only items configured on the template can be selected.
<i>Base color</i>	Select the column's background color or fill color if <i>Display</i> is set to "Bar" or "Indicators". Note that the base color can be overridden by threshold or highlight colors.

Column parameters specific to numeric type items:

<i>Display</i>	Select how the item value should be displayed: As is - as regular text; Bar - as solid, color-filled bar; Indicators - as segmented, color-filled bar.
<i>Min</i>	Enter the minimum value for bar/indicators. If left empty, the widget will use the minimum value of the item. This parameter is available only when <i>Display</i> is set to "Bar" or "Indicators".
<i>Max</i>	Enter the maximum value for bar/indicators. If left empty, the widget will use the maximum value of the item. This parameter is available only when <i>Display</i> is set to "Bar" or "Indicators".

<i>Thresholds</i>	Click <i>Add</i> to add a threshold, select a threshold color from the color picker, and specify a numeric value. The thresholds list will be sorted in ascending order when saved.
<i>History data</i>	Suffixes (for example, "1d", "2w", "4K", "8G") are supported. Value mappings are supported. Select whether to take data from history or trends: Auto - automatic selection; History - take history data; Trends - take trend data.

Column parameters specific to character, text, and log type items:

<i>Highlights</i>	Click <i>Add</i> to add a highlight, select a highlight color from the color picker, and specify a regular expression. The selected color will be used as the background color for item values where the specified regular expression matches the text.
<i>Display</i>	Select how the item value should be displayed: As is - displayed as is: - linebreaks are observed if the incoming value has line returns; - no word wrapping with horizontal layout or vertical layout with one column; word wrapping with vertical layout and more than one column. Hovering or clicking on the value opens a pop-up with the value. HTML - as HTML text; Single line - as a single line, truncated to a specified length (1-500 characters). Hovering or clicking on the truncated value opens a pop-up with the full value.
<i>Use monospace font</i>	Mark this checkbox to display the item value in monospace font (unmarked by default).
<i>Display local time</i>	Mark this checkbox to display local time instead of timestamp in the timestamp column. Note that the <i>Show timestamp</i> checkbox in advanced configuration must also be marked. This parameter is available only for log type items.

Column parameters specific to binary type items:

<i>Show thumbnail</i>	Mark this checkbox to display a thumbnail for image binaries or a "Show" option for non-image binaries. Unmark this checkbox to display a "Show" option for all binary item values. Hovering or clicking the "Show" option opens a pop-up window with the item value (image or Base64 string). If the item value is an empty string, the "Show" option is displayed; hovering or clicking it opens a pop-up containing "Empty string".
-----------------------	---

Advanced configuration

Advanced configuration options are available in the collapsible *Advanced configuration* section:

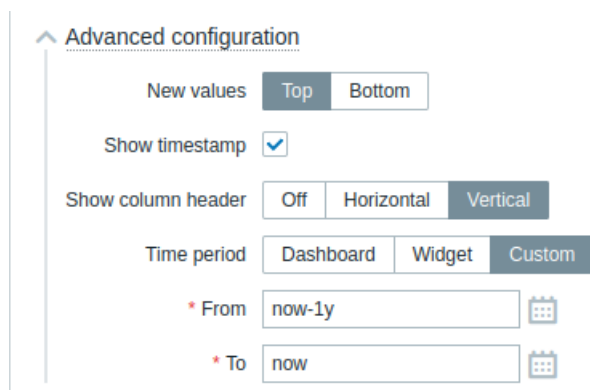

<i>New values</i>	Select where new item values should be added: Top - at the top of columns; Bottom - at the bottom of columns.
<i>Show timestamp</i>	Mark this checkbox to display the timestamp column (unmarked by default).

<i>Show column header</i>	Select the column header orientation: Off - hide the header; Horizontal - display the header horizontally; Vertical - display the header vertically.
<i>Time period</i>	Select the data source for the time period: Dashboard - set the <i>Time period selector</i> as the data source; Widget - set a compatible widget specified in the <i>Widget</i> parameter as the data source; Custom - set the time period specified in the <i>From</i> and <i>To</i> parameters as the data source; if set, a clock icon will be displayed in the top right corner of the widget, indicating the set time on mouseover.
<i>Widget</i>	Enter or select a compatible widget (<i>Graph</i> , <i>Graph (classic)</i> , <i>Graph prototype</i>) as the data source for the time period.
<i>From</i>	This parameter is available if <i>Time period</i> is set to "Widget". Enter or select the start of the time period. Relative time syntax (<code>now</code> , <code>now/d</code> , <code>now/w-1w</code> , etc.) is supported.
<i>To</i>	This parameter is available if <i>Time period</i> is set to "Custom". Enter or select the end of the time period. Relative time syntax (<code>now</code> , <code>now/d</code> , <code>now/w-1w</code> , etc.) is supported. This parameter is available if <i>Time period</i> is set to "Custom".

16 Item navigator

Overview

The item navigator widget displays items based on various filtering and grouping options.

Item navigator	
▼ Linux servers	3 1 2
▼ Riga	3 1 2
▼ linux-server-01	3 1 2
▶ cpu	1 2
▼ memory	3
Available memory	1
Available memory in %	1
Memory utilization	1
Total memory	
▶ linux-server-02	
▶ linux-server-03	
▶ linux-server-04	
▶ linux-server-05	
▼ Zabbix servers	1
▼ Uncategorized	1
▶ zbx-Riga	1
▶ zbx-Tokyo	

The widget also allows to control the information displayed in other widgets based on the selected item.

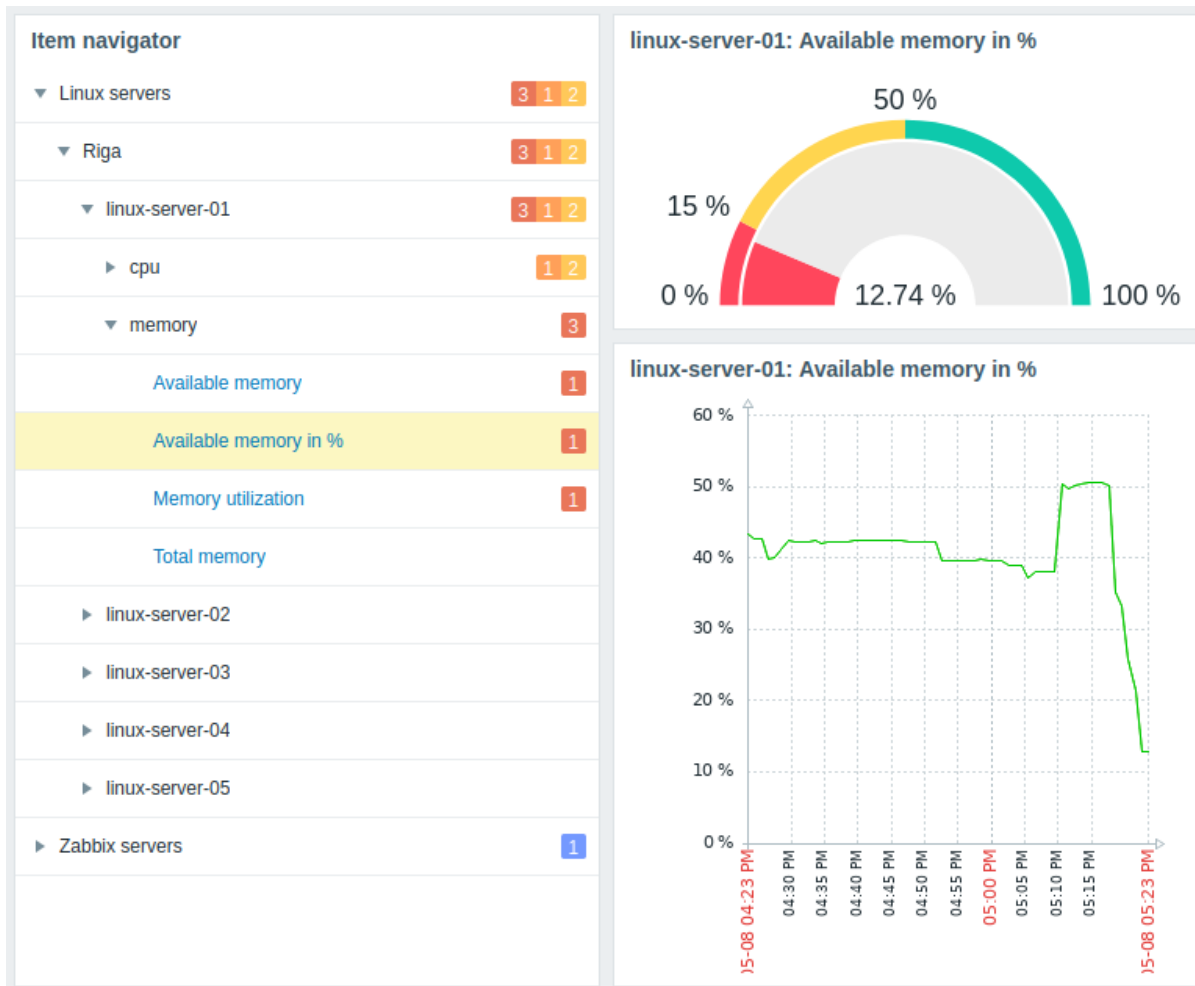

Groups by which items are organized can be expanded or collapsed.

For groups and problems, additional details are accessible by mouseover hints.

Configuration

To configure, select *Item navigator* as type:

Add widget
? X

Type

Name

Refresh interval

Host groups

Hosts

Host tags And/Or Or

[Add](#)

Show header

Item patterns

Item tags And/Or Or

[Add](#)

State All Normal Not supported

Show problems All Unsuppressed None

Group by

1:

2:

3:

4:

[Add](#)

* Item limit

In addition to the parameters that are **common** for all widgets, you may set the following specific options:

<i>Host groups</i>	<p>Select host groups.</p> <p>Alternatively, select a compatible widget as the data source for host groups.</p> <p>This field is auto-complete, so starting to type the name of a group will offer a dropdown of matching groups.</p> <p>Selecting a parent host group implicitly selects all nested host groups; if no host groups are selected, the widget will display items belonging to all hosts from all host groups.</p>
<i>Hosts</i>	<p>This parameter is not available when configuring the widget on a template dashboard.</p> <p>Select hosts.</p> <p>Alternatively, select a compatible widget or the dashboard as the data source for hosts.</p> <p>This field is auto-complete, so starting to type the name of a host will offer a dropdown of matching hosts.</p> <p>If no hosts are selected, the widget will display items belonging to all hosts.</p> <p>This parameter is not available when configuring the widget on a template dashboard.</p>

<i>Host tags</i>	<p>Specify tags to filter the items displayed in the widget. It is possible to include as well as exclude specific tags and tag values. Several conditions can be set. Tag name matching is always case-sensitive.</p> <p>There are several operators available for each condition: Exists - include the specified tag names; Equals - include the specified tag names and values (case-sensitive); Contains - include the specified tag names where the tag values contain the entered string (substring match, case-insensitive); Does not exist - exclude the specified tag names; Does not equal - exclude the specified tag names and values (case-sensitive); Does not contain - exclude the specified tag names where the tag values contain the entered string (substring match, case-insensitive).</p> <p>There are two calculation types for conditions: And/Or - all conditions must be met, conditions having the same tag name will be grouped by the Or condition; Or - enough if one condition is met.</p>
<i>Item patterns</i>	<p>This parameter is not available when configuring the widget on a template dashboard. Enter item patterns or select existing items as item patterns. Items that match the specified patterns will be displayed on the item navigator.</p> <p>Wildcard patterns may be used for selection (for example, * will return items that match zero or more characters; Zabbix* will return items that start with "Zabbix"). To specify a wildcard pattern, enter the string manually and press <i>Enter</i>. When you start typing, a dropdown list will show matching items limited to those belonging to selected <i>Hosts</i> or hosts within selected <i>Host groups</i>, if any. The wildcard symbol is always interpreted, therefore, it is not possible to add, for example, an item named <i>item*</i> individually, if there are other matching items (e.g., <i>item2</i>, <i>item3</i>).</p> <p>When configuring the widget on a template dashboard, this parameter allows selecting only items configured on the template.</p>
<i>Item tags</i>	<p>Specify tags to filter the items displayed in the widget. It is possible to include as well as exclude specific tags and tag values. Several conditions can be set. Tag name matching is always case-sensitive.</p> <p>There are several operators available for each condition: Exists - include the specified tag names; Equals - include the specified tag names and values (case-sensitive); Contains - include the specified tag names where the tag values contain the entered string (substring match, case-insensitive); Does not exist - exclude the specified tag names; Does not equal - exclude the specified tag names and values (case-sensitive); Does not contain - exclude the specified tag names where the tag values contain the entered string (substring match, case-insensitive).</p> <p>There are two calculation types for conditions: And/Or - all conditions must be met, conditions having the same tag name will be grouped by the Or condition; Or - enough if one condition is met.</p>
<i>State</i>	Filter which items to display based on their state (all, normal, not supported).
<i>Show problems</i>	Filter which problems to display with items based on their status (all, unsuppressed, none).

Group by

Add a grouping attribute by which to group items:

Host group - group items by host groups of their hosts;

Host name - group items by their hosts;

Host tag value - enter a tag name to group items by the values of this host tag (for example, enter "city" to group items by values "Riga", "Tokyo", etc.);

Item tag value - enter a tag name to group items by the values of this item tag (for example, enter "component" to group items by values "cpu", "memory", etc.).

Grouping attributes can be reordered by dragging up or down by the handle before the group name. Note that grouping attribute order determines group nesting order. For example, specifying multiple host tag names (1: color, 2: city) will result in items being grouped by color (red, blue, etc.) and then by city (Riga, Tokyo, etc.).

An item may be displayed in multiple groups depending on the configured grouping attributes (for example, when grouping by host group and the item's host belongs to multiple host groups). Clicking such items selects and highlights them in all groups.

Items that do not match the configured grouping attributes are displayed in the *Uncategorized* group.

If *Show problems* is configured to display problems, they are displayed as follows:

- for each group, all subordinate item problem count is displayed;
- for each item, only its problem count is displayed.

Up to 10 grouping attributes can be specified, and all must be unique.

If no grouping attributes are specified, items will not be grouped.

Item limit

Enter the maximum number of items to be displayed. Possible values range from 1-9999.

When more items are available for displaying than the set limit, a corresponding message is shown below the displayed items (for example, "100 of 100+ items are shown").

Note that the configured item limit also affects the display of configured groups; for example, if item limit is set to 100 and items are grouped by their hosts (each containing 200 items), only the first host with its 100 items will be displayed in the widget.

This parameter is not affected by the *Limit for search and filter results* parameter in *Administration* → *General* → *GUI*.

17 Item value

Overview

This widget is useful for displaying the value of a single item prominently. This can be the latest value as well as an aggregated value for some period in the past.

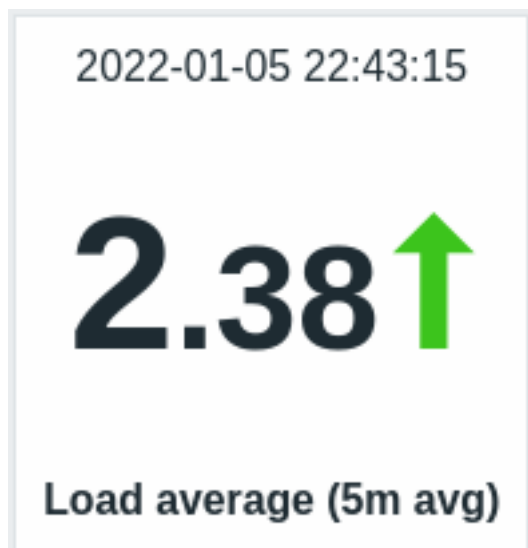

Besides the value itself, additional elements can be displayed, if desired:

- Time of the metric
- Item description
- Change indicator for the value
- Background color for the value
- Item unit
- Sparkline chart for values from the specified time period

The widget can display numeric and string values. Displaying binary values is not supported. String values are displayed on a single line and truncated, if needed. "No data" is displayed, if there is no value for the item.

The change indicator always compares with the same period in the past. So, for example, the latest value will be compared with the previous value, while the latest month will be compared with the month before. Note that the previous period for aggregations is calculated as time period of the same length as the original one with ending time directly before the starting time of the original period.

Clicking on the value leads to an [ad-hoc graph](#) for numeric items or latest data for string items.

The widget and all elements in it can be visually fine-tuned using [advanced configuration](#) options, allowing to create a wide variety of visual styles:

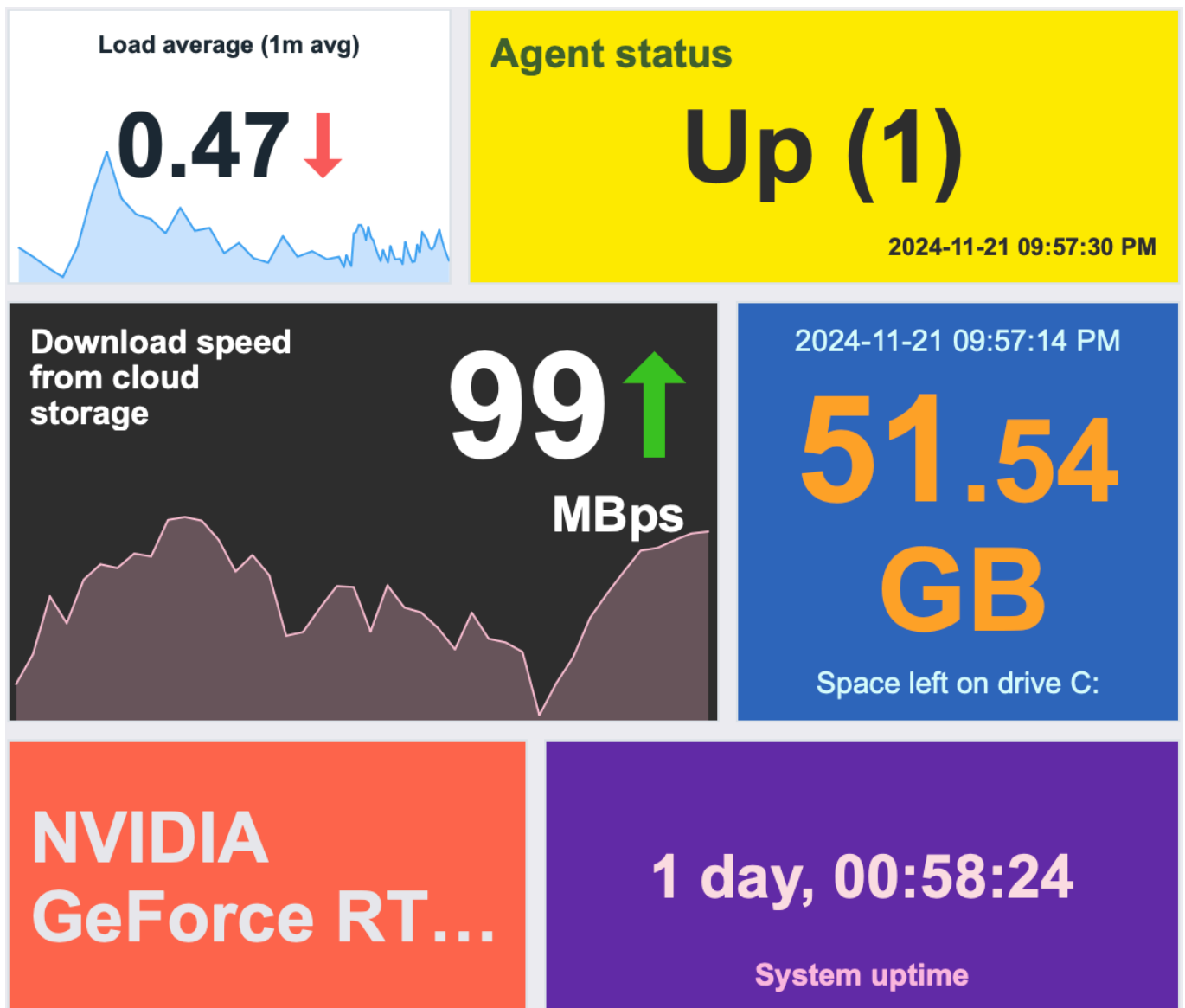

Configuration

To configure, select *Item value* as the widget type:

Add widget ? X

Type Show header

Name

Refresh interval

* Item Select

* Show Description Value
 Time Change indicator
 Sparkline

Override host Select

Advanced configuration

In addition to the parameters that are **common** for all widgets, you may set the following specific options:

<i>Item</i>	Select the item. Alternatively, select a compatible widget as the data source for items.
<i>Show</i>	Mark the checkbox to display the respective element: description , value , time , change indicator , sparkline . Unmark to hide. At least one element must be selected.
<i>Override host</i>	Select a compatible widget or the dashboard as the data source for hosts. This parameter is not available when configuring the widget on a template dashboard .
<i>Advanced configuration</i>	Click the <i>Advanced configuration</i> label to display advanced configuration options.

Advanced configuration

Advanced configuration options are available in the collapsible *Advanced configuration* section, and only for those elements that are selected in the *Show* field (see above).

Note that multiple elements cannot occupy the same space; if they are placed in the same space, an error message will be displayed.

Generic widget parameters

These parameters determine the background color (static or dynamic) for the whole widget and an aggregation function for displaying values.

Background color

Thresholds

	Threshold	
■	<input type="text" value="80"/>	Remove
■	<input type="text" value="60"/>	Remove
■	<input type="text" value="40"/>	Remove
Add		

Aggregation function

Time period

* From

* To

History data

<i>Background color</i>	Select the background color for the whole widget from the color picker. D stands for default color (depends on the frontend theme). To return to the default value, click the <i>Use default</i> button in the color picker.
<i>Thresholds</i>	Configure the dynamic background color for the whole widget. Click <i>Add</i> to add a threshold, select the background color from the color picker, and specify a numeric value. Once the item value equals or is greater than the threshold value, the background color will change. The list will be sorted in ascending order when saved.
<i>Aggregation function</i>	Note that the dynamic background color will be displayed correctly only for numeric items. Specify which aggregation function to use: min - display the smallest value; max - display the largest value; avg - display the average value; count - display the count of values; sum - display the sum of values; first - display the first value; last - display the last value; not used - display the most recent value (no aggregation). Aggregation allows to display an aggregated value for the chosen interval (5 minutes, an hour, a day), instead of the most recent value. Only numeric data can be displayed for <i>min</i> , <i>max</i> , <i>avg</i> and <i>sum</i> . For <i>count</i> , non-numeric data will be changed to numeric.
<i>Time period</i>	Specify the time period to use for aggregating values: Dashboard - use time period of the dashboard; Widget - use time period of the specified widget; Custom - use a custom time period. <This parameter will not be displayed if <i>Aggregation function</i> is set to "not used".
<i>Widget</i>	Select the widget. This parameter will only be displayed if <i>Time period</i> is set to "Widget".
<i>From</i>	Select the time period from (default value <code>now-1h</code>). See relative time syntax . This parameter will only be displayed if <i>Time period</i> is set to "Custom".
<i>To</i>	Select the time period to (default value <code>now</code>). See relative time syntax . This parameter will only be displayed if <i>Time period</i> is set to "Custom".
<i>History data</i>	Take data from history or trends: Auto - automatic selection; History - take history data; Trends - take trend data. This setting applies only to numeric data. Non-numeric data will always be taken from history.

Description

These parameters determine how the item description should be displayed.

* Description ?

```
{HOST.NAME}
CPU utilization %
```

Horizontal position Left Center Right

Vertical position Top Middle Bottom

Size %

Bold

Color

<i>Description</i>	Enter the item description. This description may override the default item name. Multiline descriptions are supported. A combination of text and supported macros is possible. {HOST.*}, {ITEM.*}, {INVENTORY.*} and user macros are supported.
<i>Horizontal position</i>	Select horizontal position of the item description - left, right or center.
<i>Vertical position</i>	Select vertical position of the item description - top, bottom or middle.

<i>Size</i>	Enter font size height for the item description (in percent relative to total widget height).
<i>Bold</i>	Mark the checkbox to display item description in bold type.
<i>Color</i>	Select the item description color from the color picker. D stands for default color (depends on the frontend theme). To return to the default value, click the <i>Use default</i> button in the color picker.

Value

These parameters determine how the item value should be displayed.

Value	Decimal places	<input type="text" value="2"/>	Size	<input type="text" value="35"/>	%
	Horizontal position	<input type="button" value="Left"/> <input checked="" type="button" value="Center"/> <input type="button" value="Right"/>	Size	<input type="text" value="45"/>	%
	Vertical position	<input type="button" value="Top"/> <input checked="" type="button" value="Middle"/> <input type="button" value="Bottom"/>	Bold	<input checked="" type="checkbox"/>	
			Color	<input type="text" value="D"/>	
	<input checked="" type="checkbox"/> Units	<input type="text" value="%"/>			
	Position ?	<input type="text" value="After value"/>	Size	<input type="text" value="35"/>	%
			Bold	<input type="checkbox"/>	
			Color	<input type="text" value="D"/>	

<i>Decimal places</i>	Select how many decimal places will be displayed with the value. This value will affect only float items.
<i>Size</i>	Enter font size height for the decimal places (in percent relative to total widget height).
<i>Horizontal position</i>	Select horizontal position of the item value - left, right or center.
<i>Vertical position</i>	Select vertical position of the item value - top, bottom or middle.
<i>Size</i>	Enter font size height for the item value (in percent relative to total widget height). Note that the size of item value is prioritized; other elements have to concede space for the value. With the change indicator though, if the value is too large, it will be truncated to show the change indicator.
<i>Bold</i>	Mark the checkbox to display item value in bold type.
<i>Color</i>	Select the item value color from the color picker. D stands for default color (depends on the frontend theme). To return to the default value, click the <i>Use default</i> button in the color picker.
Units	
<i>Units</i>	Mark the checkbox to display units with the item value. If you enter a unit name, it will override the unit from item configuration.
<i>Position</i>	Select the item unit position - above, below, before or after the value.
<i>Size</i>	Enter font size height for the item unit (in percent relative to total widget height).
<i>Bold</i>	Mark the checkbox to display item unit in bold type.
<i>Color</i>	Select the item unit color from the color picker. D stands for default color (depends on the frontend theme). To return to the default value, click the <i>Use default</i> button in the color picker.

Time

These parameters determine how the time (clock value from the item history) should be displayed.

Time	Horizontal position	<input type="button" value="Left"/> <input checked="" type="button" value="Center"/> <input type="button" value="Right"/>	Size	<input type="text" value="15"/>	%
	Vertical position	<input checked="" type="button" value="Top"/> <input type="button" value="Middle"/> <input type="button" value="Bottom"/>	Bold	<input type="checkbox"/>	
			Color	<input type="text" value="D"/>	

<i>Horizontal position</i>	Select horizontal position of the time - left, right or center.
<i>Vertical position</i>	Select vertical position of the time - top, bottom or middle.
<i>Size</i>	Enter font size height for the time (in percent relative to total widget height).

<i>Bold</i>	Mark the checkbox to display time in bold type.
<i>Color</i>	Select the time color from the color picker. D stands for default color (depends on the frontend theme). To return to the default value, click the <i>Use default</i> button in the color picker.

Change indicator

This section allows to select the color of change indicators from the color picker.



The change indicators are as follows:

- ↑ - item value is up (for numeric items)
- ↓ - item value is down (for numeric items)
- ↕ - item value has changed (for string items and items with value mapping)

D stands for default color (depends on the frontend theme). To return to the default value, click the *Use default* button in the color picker.

Vertical size of the change indicator is equal to the size of the value (integer part of the value for numeric items).

Note that up and down indicators are not shown with just one value.

Sparkline

These parameters determine how the sparkline chart should be displayed.

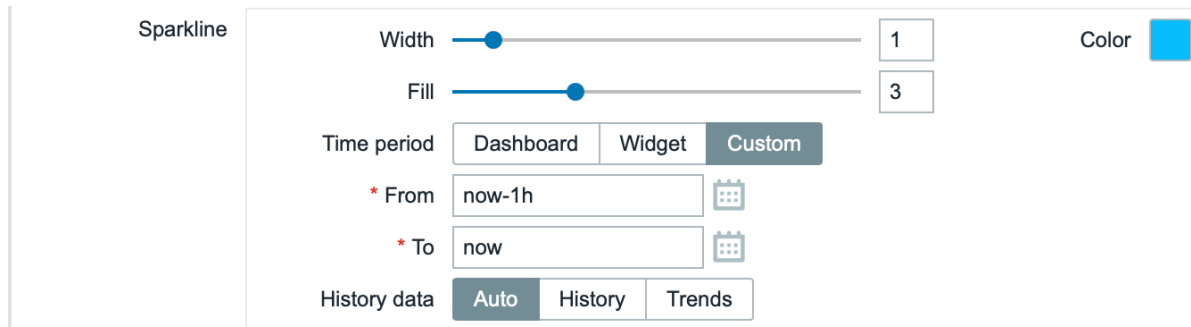

<i>Width</i>	Set the graph line thickness by using the slider or manually entering a value in the range from 0 to 10.
<i>Color</i>	Select line and fill color.
<i>Fill</i>	Set fill color transparency level by using the slider or manually entering a value in the range from 0 to 10.
<i>Time period</i>	Specify the time period for values to be included into the sparkline chart: Dashboard - use time period of the dashboard; Widget - use time period of the specified widget; Custom - use a custom time period.
<i>Widget</i>	Select the widget.
<i>From</i>	This parameter will only be displayed if <i>Time period</i> is set to "Widget". Select the time period from (default value <code>now-1h</code>). See relative time syntax .
<i>To</i>	This parameter will only be displayed if <i>Time period</i> is set to "Custom". Select the time period to (default value <code>now</code>). See relative time syntax .
<i>History data</i>	This parameter will only be displayed if <i>Time period</i> is set to "Custom". Take data from history or trends: Auto - automatic selection; History - take history data; Trends - take trend data.

In the map widget you can display either:

- a single configured network map;
- one of the configured network maps in the **map navigation tree** (when clicking on the map name in the tree).

Configuration

To configure, select *Map* as type:

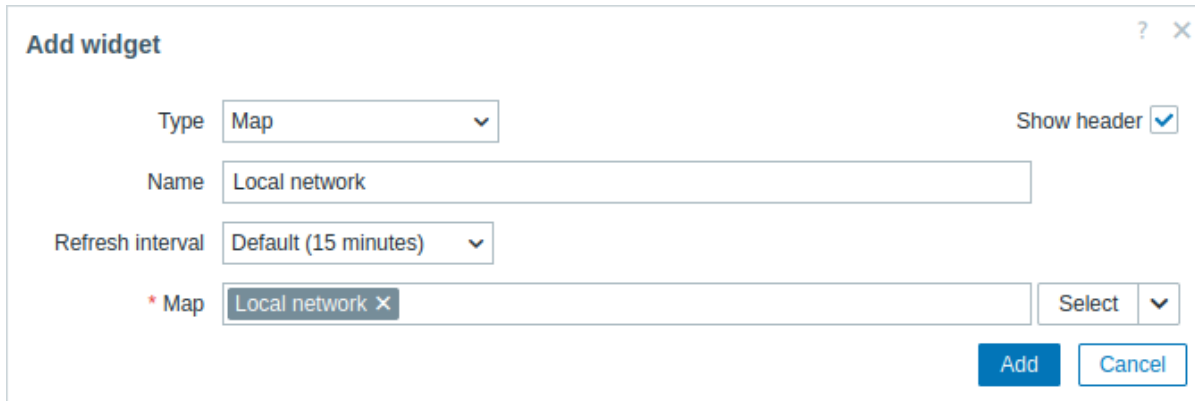

In addition to the parameters that are **common** for all widgets, you may set the following specific options:

Map	Set a map to display. Alternatively, select a compatible widget as the data source for the map to display. This field is auto-complete, so starting to type the name of the map or widget will offer a dropdown of matching maps or widgets.
------------	---

19 Map navigation tree

Overview

This widget allows building a hierarchy of existing maps while also displaying problem statistics with each included map and map group.

It becomes even more powerful if you link the *Map* widget to the navigation tree. In this case, clicking on a map name in the navigation tree displays the map in full in the *Map* widget.



Statistics with the top-level map in the hierarchy display a sum of problems of all submaps and their own problems.

Configuration

To configure, select *Map navigation tree* as type:

Add widget ? X

Type Map navigation tree Show header

Name Map tree

Refresh interval Default (15 minutes)

Show unavailable maps

Add
Cancel

In addition to the parameters that are **common** for all widgets, you may set the following specific options:

<i>Show unavailable maps</i>	<p>Mark this checkbox to display maps that the user does not have read permission to. Unavailable maps in the navigation tree will be displayed with a grayed-out icon. Note that if this checkbox is marked, available submaps are displayed even if the parent level map is unavailable. If unmarked, available submaps to an unavailable parent map will not be displayed at all.</p> <p>Problem count is calculated based on available maps and available map elements.</p>
------------------------------	--

Navigation tree elements are displayed in a list. You can:

- drag an element (including its child elements) to a new place in the list;
- expand or collapse an element to display or hide its child elements;
- add a child element (with or without a linked map) to an element;
- add multiple child elements (with linked maps) to an element;
- edit an element;
- remove an element (including its child elements).

Map tree ⚙️ ⋮

root	+ 📄
⋮ ▼ All	+ 📄 ↙ ×
⋮ Stockholm	+ 📄 ↙ ×
⋮ London	+ 📄 ↙ ×
⋮ ▶ Munich	+ 📄 ↙ ×

Element configuration

To configure a navigation tree element, either add a new element or edit an existing element.

Edit tree element ✕

*** Name**

Linked map

Add submaps

The following navigation tree element configuration parameters are available:

<i>Name</i>	Enter the navigation tree element name.
<i>Linked map</i>	Select the map to link to the navigation tree element. This field is auto-complete, so starting to type the name of a map will offer a dropdown of matching maps.
<i>Add submaps</i>	Mark this checkbox to add the submaps of the linked map as child elements to the navigation tree element.

20 Pie chart

Overview

The pie chart widget allows to display values of selected items as a **pie** or **doughnut** chart.

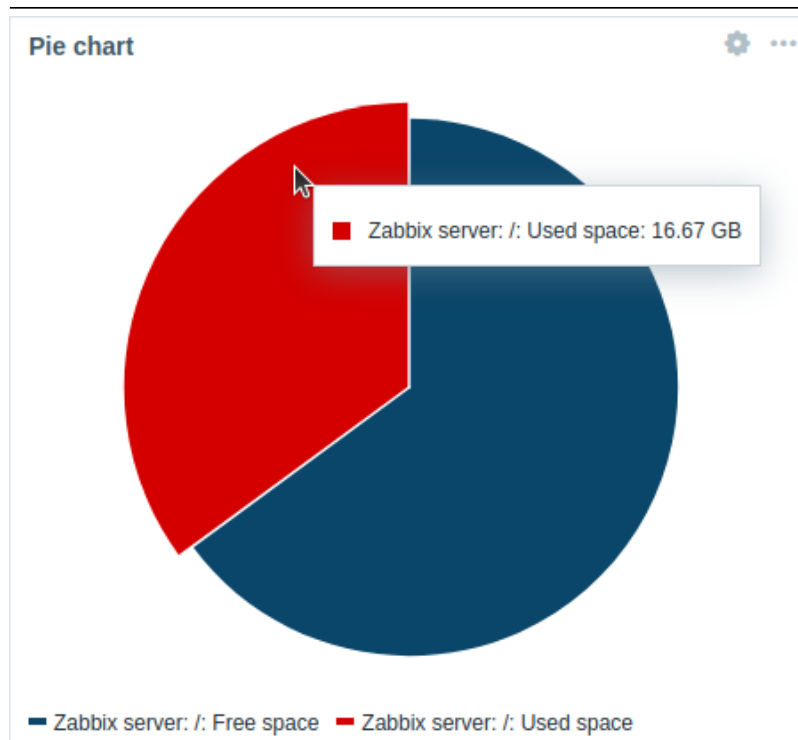

Pie chart.

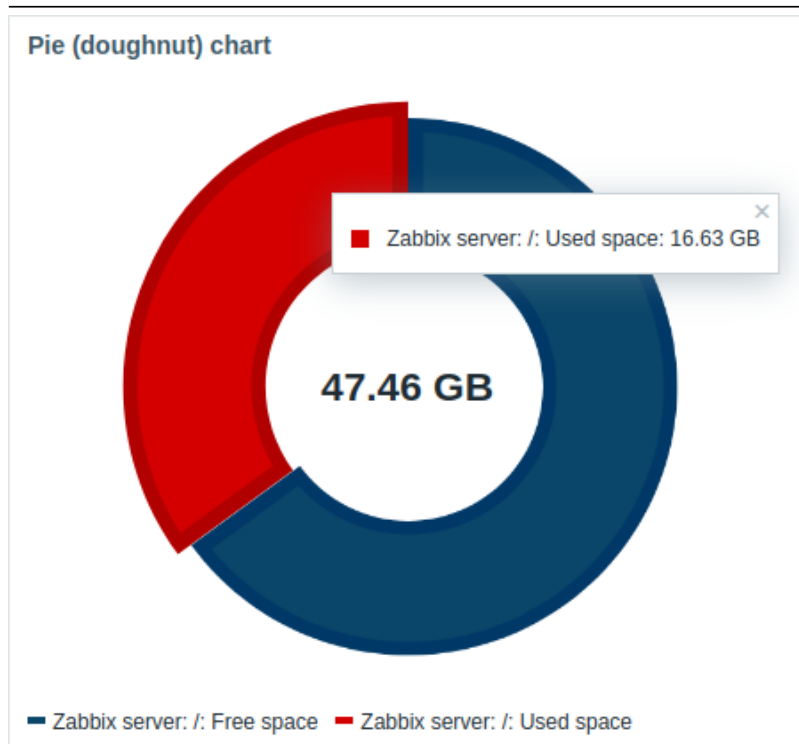

Doughnut chart.

On mouseover, the focused sector enlarges outwards and the legend for this sector is displayed. Clicking on the focused sector makes the pop-out effect permanent, until closed with "x".

The charts are drawn using a vector image drawing technique.

Configuration

To configure, select *Pie chart* as type:

Data set

The **Data set** tab allows selecting data for the pie chart by adding data sets. Two types of data sets can be added:

- *Item patterns* - data from matching items is displayed. The chart is drawn using different shades of single color for each item.
- *Item list* - data from selected items is displayed. The chart is drawn using different colors for each item.

By default, an *Item patterns* data set is added.

<i>Data set</i>	<p>For Item patterns data set:</p> <p>Select or enter host and item patterns; data of items that match the entered patterns will be displayed on the pie chart; up to 50 items may be displayed.</p> <p>Wildcard patterns may be used for selection (for example, * will return results that match zero or more characters).</p> <p>To specify a wildcard pattern, enter the string manually and press <i>Enter</i>.</p> <p>The wildcard symbol is always interpreted, so it is not possible to add, for example, an item named <i>item*</i> individually if there are other matching items (for example, <i>item2</i>, <i>item3</i>).</p> <p>Specifying host and item patterns is mandatory for "Item patterns" data sets.</p> <p>See also: Data set configuration details.</p> <p>For Item list data set:</p> <p>Select items for the pie chart by clicking on the <i>Add item</i> button.</p> <p>The <i>Type</i> dropdown after the item name allows to select the display type for each item:</p> <p>Normal - item value is represented proportionally on the pie chart (default);</p> <p>Total - item value takes up the whole pie chart. Note that only one "Total" item can exist per pie chart, and it will be placed first on the pie chart legend. If an item is set to "Total", the <i>Data set aggregation</i> parameter (see below) will be disabled and set to "not used".</p> <p>You may also select compatible widgets as the data source for items by clicking on the <i>Add widget</i> button. The same options apply to widgets as to individual items.</p> <p>Specifying items or widgets is mandatory for "Item list" data sets.</p> <p>See also: Data set configuration details.</p> <p>Note that only numeric item types are allowed.</p> <p>When configuring the widget on a template dashboard, the parameter for specifying host patterns is not available, and the parameter for specifying an item list allows to select only the items configured on the template.</p>
<i>Aggregation function</i>	<p>Specify which aggregation function to use for each item in the data set:</p> <p>min - display the smallest value;</p> <p>max - display the largest value;</p> <p>avg - display the average value;</p> <p>sum - display the sum of values;</p> <p>count - display the count of values;</p> <p>first - display the first value;</p> <p>last - display the last value (default).</p>
<i>Data set aggregation</i>	<p>Aggregation allows to display an aggregated value for the interval (5 minutes, an hour, a day) selected in the <i>Time period</i> tab or used for the whole dashboard.</p> <p>Specify which aggregation function to use for the whole data set:</p> <p>not used - no aggregation, items are displayed separately (default);</p> <p>min - display the smallest value;</p> <p>max - display the largest value;</p> <p>avg - display the average value;</p> <p>sum - display the sum of values;</p> <p>count - display the count of values.</p>
<i>Data set label</i>	<p>Aggregation allows to display an aggregated value for the interval (5 minutes, an hour, a day) selected in the <i>Time period</i> tab or used for the whole dashboard.</p> <p>Specify a custom label for the data set.</p> <p>The label is displayed in the data set configuration and the pie chart legend (for aggregated data sets).</p> <p>All data sets are numbered including those with a specified <i>Data set label</i>. If no label is specified, the data set will be labeled automatically according to its number (e.g. "Data set #2", "Data set #3", etc.). Data set numbering is recalculated after reordering/dragging data sets.</p> <p>Data set labels that are too long will be shortened to fit where displayed (e.g. "Number of proc...").</p>

Data set configuration details

Existing data sets are displayed in a list. You can rearrange, expand/collapse, change colors, and clone these data sets.

For more information, see data set configuration details in the *Graph* widget. These details also apply to the *Pie chart* widget.

Displaying options

The **Displaying options** tab allows to define history data selection and visualization options for the pie chart:

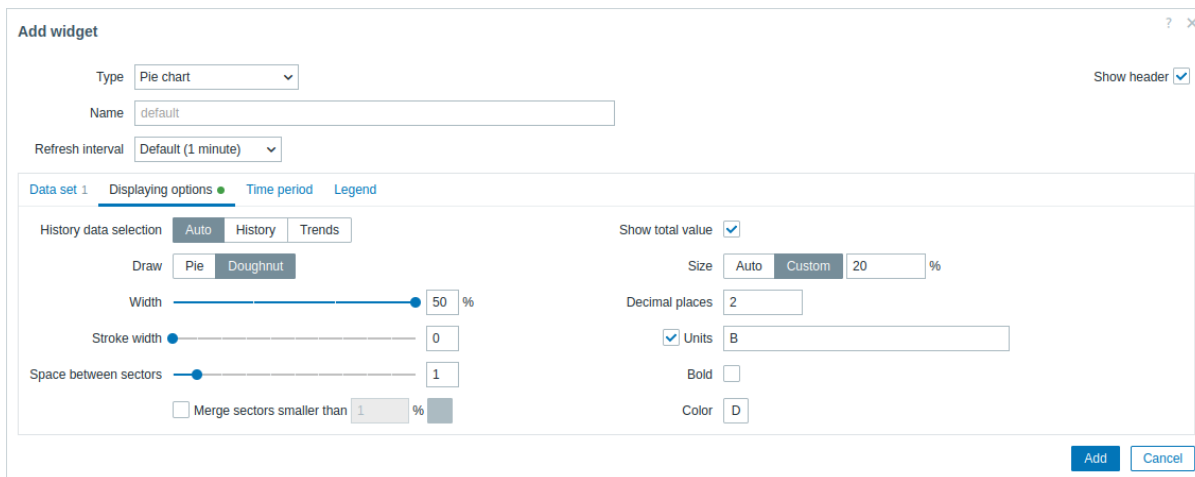

History data selection
Draw

Select the data source:
Auto - data are sourced according to the classic **algorithm** (default);
History - data from history;
Trends - data from trends.

Space between sectors

Select the visualization style of the pie chart:
Pie - a full pie (sectors take up 100% of the radius);
Doughnut - a pie with empty circle in the middle (sectors use up to 50% of radius).
Select the space size (in units of 0-10) between sectors (default is "1").

Merge sectors smaller than N%

Mark the checkbox to merge sectors smaller than the N%.
If enabled, select the color for the merged sectors and the percentage threshold (N) for merging small sectors.

Draw style:
Doughnut

Width
Stroke width
Show total value

Select the doughnut width: 20, 30, 40 or 50% (default) of the radius.
Select the width of the doughnut sector border (0-10).
Mark the checkbox to show the total value in the middle of the doughnut chart.

Size

Select the size option for the total value:
Auto - the text is sized automatically to fit the doughnut middle readably;
Custom - specify the text size as height percentage from the total widget height.

Decimal places

Specify the number of decimal places for the total value (0-6).

Units

Specify the units for the total value.

Bold

Mark the checkbox to display the total value in bold.

Color

Select the color for the total value.

Time period

The **Time period** tab allows to set a custom time period for the aggregation settings of the pie chart:

Time period Select the **data source** for the time period:
Dashboard - set the *Time period* selector as the data source;
Widget - set a compatible widget specified in the *Widget* parameter as the data source;
Custom - set the time period specified in the *From* and *To* parameters as the data source; if set, a clock icon will be displayed in the top right corner of the widget, indicating the set time on mouseover.

Widget Enter or select a compatible widget (*Graph*, *Graph (classic)*, *Graph prototype*) as the data source for the time period.
This parameter is available if *Time period* is set to "Widget".

From Enter or select the start of the time period.
Relative time syntax (*now*, *now/d*, *now/w-1w*, etc.) is supported.
This parameter is available if *Time period* is set to "Custom".

To Enter or select the end of the time period.
Relative time syntax (*now*, *now/d*, *now/w-1w*, etc.) is supported.
This parameter is available if *Time period* is set to "Custom".

Legend

The **Legend** tab allows to customize the pie chart legend:

Show legend Unmark this checkbox to hide the legend on the pie chart (marked by default).

Show value Mark this checkbox to show the value of the item in the legend.

Show aggregation function Mark this checkbox to show the aggregation function in the legend.

Rows Select the display mode for legend rows:
Fixed - the number of rows displayed is determined by the *Number of rows* parameter value;
Variable - the number of rows displayed is determined by the amount of configured items while not exceeding the *Maximum number of rows* parameter value.

Number of rows/
Maximum number of
rows If *Rows* is set to "Fixed", set the number of legend rows to be displayed (1-10).
If *Rows* is set to "Variable", set the maximum number of legend rows to be displayed (1-10).

Number of columns Set the number of legend columns to be displayed (1-4).
This parameter is available if *Show value* is unmarked.

The information displayed by the pie chart widget can be downloaded as a *.png* image using the **widget menu**.
A screenshot of the widget will be saved to the *Downloads* folder.

21 Problem hosts

Overview

In the problem host widget, you can display problem count by host group and the highest problem severity within a group. The problem count is displayed only for cause problems.

Configuration

To configure, select *Problem hosts* as type:

The screenshot shows the 'Add widget' configuration window. The 'Type' is set to 'Problem hosts'. The 'Name' is 'default'. The 'Refresh interval' is 'Default (1 minute)'. There are three search fields for 'Host groups', 'Exclude host groups', and 'Hosts', each with a 'Select' button. The 'Problem' field is empty. Under 'Severity', there are checkboxes for 'Not classified', 'Warning', 'High', 'Information', 'Average', and 'Disaster'. The 'Problem tags' section has 'And/Or' and 'Or' buttons, and a tag configuration field with 'tag', 'Contains', 'value', and 'Remove' options. There are checkboxes for 'Show suppressed problems' and 'Hide groups without problems'. The 'Problem display' section has buttons for 'All', 'Separated', and 'Unacknowledged only'. 'Add' and 'Cancel' buttons are at the bottom right.

In addition to the parameters that are **common** for all widgets, you may set the following specific options:

Host groups

Select host groups to display in the widget. Alternatively, select a compatible widget as the **data source** for host groups. This field is auto-complete, so starting to type the name of a group will offer a dropdown of matching groups. Specifying a parent host group implicitly selects all nested host groups. Host data from these host groups will be displayed in the widget; if no host groups are entered, all host groups will be displayed.

Exclude host groups

This parameter is not available when configuring the widget on a **template dashboard**. Select host groups to hide from the widget. This field is auto-complete, so starting to type the name of a group will offer a dropdown of matching groups. Specifying a parent host group implicitly selects all nested host groups. Host data from these host groups will not be displayed in the widget. For example, hosts 001, 002, 003 may be in Group A and hosts 002, 003 in Group B as well. If we select to *show* Group A and *exclude* Group B at the same time, only data from host 001 will be displayed in the dashboard. This parameter is not available when configuring the widget on a **template dashboard**.

<i>Hosts</i>	<p>Select hosts to display in the widget.</p> <p>Alternatively, select a compatible widget or the dashboard as the data source for hosts. This field is auto-complete, so starting to type the name of a host will offer a dropdown of matching hosts.</p> <p>If no hosts are entered, all hosts will be displayed.</p> <p>This parameter is not available when configuring the widget on a template dashboard.</p>
<i>Problem</i>	<p>You can limit the number of problem hosts displayed by the problem name.</p> <p>If you enter a string here, only those hosts with problems whose name contains the entered string will be displayed.</p> <p>Macros are not expanded.</p>
<i>Severity</i>	<p>Mark problem severities to filter problems to be displayed in the widget.</p> <p>If no severities are marked, all problems will be displayed.</p>
<i>Problem tags</i>	<p>Specify problem tags to limit the number of problems displayed in the widget.</p> <p>It is possible to include as well as exclude specific tags and tag values. Several conditions can be set. Tag name matching is always case-sensitive.</p> <p>There are several operators available for each condition:</p> <p>Exists - include the specified tag names;</p> <p>Equals - include the specified tag names and values (case-sensitive);</p> <p>Contains - include the specified tag names where the tag values contain the entered string (substring match, case-insensitive);</p> <p>Does not exist - exclude the specified tag names;</p> <p>Does not equal - exclude the specified tag names and values (case-sensitive);</p> <p>Does not contain - exclude the specified tag names where the tag values contain the entered string (substring match, case-insensitive).</p> <p>There are two calculation types for conditions:</p> <p>And/Or - all conditions must be met, conditions having the same tag name will be grouped by the <i>Or</i> condition;</p> <p>Or - enough if one condition is met.</p>
<i>Show suppressed problems</i>	<p>Mark the checkbox to display problems that would otherwise be suppressed (not shown) because of host maintenance.</p>
<i>Hide groups without problems</i>	<p>Mark the <i>Hide groups without problems</i> option to hide data from host groups without problems in the widget.</p> <p>This parameter is not available when configuring the widget on a template dashboard.</p>
<i>Problem display</i>	<p>Display problem count as:</p> <p>All - full problem count will be displayed;</p> <p>Separated - unacknowledged problem count will be displayed separated as a number of the total problem count;</p> <p>Unacknowledged only - only the unacknowledged problem count will be displayed.</p>

22 Problems

Overview

In this widget you can display current problems. The information in this widget is similar to *Monitoring → Problems*.

Up to 1000 records can be displayed.

Configuration

To configure, select *Problems* as type:

Add widget
? X

Type

Name

Refresh interval

Show Recent problems Problems History

Host groups Select

Exclude host groups Select

Hosts Select

Problem

Severity Not classified Warning High
 Information Average Disaster

Problem tags And/Or Or

Contains [Remove](#)

[Add](#)

Show tags None 1 2 3

Tag name Full Shortened None

Tag display priority

Show operational data None Separately With problem name

Show symptoms

Show suppressed problems

Acknowledgement status All Unacknowledged Acknowledged By me

Sort entries by

Show timeline

* Show lines

Show header

Select

Select

Select

[Remove](#)

Add
Cancel

You can limit how many problems are displayed in the widget in various ways - by problem status, problem name, severity, host group, host, event tag, acknowledgment status, etc.

In addition to the parameters that are **common** for all widgets, you may set the following specific options:

<i>Show</i>	Filter by problem status: Recent problems - unresolved and recently resolved problems are displayed (default); Problems - unresolved problems are displayed; History - history of all events is displayed.
<i>Host groups</i>	Select host groups to display problems of in the widget. Alternatively, select a compatible widget as the data source for host groups. This field is auto-complete, so starting to type the name of a group will offer a dropdown of matching groups. Specifying a parent host group implicitly selects all nested host groups. Problems from these host groups will be displayed in the widget; if no host groups are entered, problems from all host groups will be displayed. This parameter is not available when configuring the widget on a template dashboard .

<i>Exclude host groups</i>	<p>Select host groups to hide problems of from the widget.</p> <p>This field is auto-complete, so starting to type the name of a group will offer a dropdown of matching groups.</p> <p>Specifying a parent host group implicitly selects all nested host groups.</p> <p>Problems from these host groups will not be displayed in the widget. For example, hosts 001, 002, 003 may be in Group A and hosts 002, 003 in Group B as well. If we select to <i>show</i> Group A and <i>exclude</i> Group B at the same time, only problems from host 001 will be displayed in the widget.</p> <p>This parameter is not available when configuring the widget on a template dashboard.</p>
<i>Hosts</i>	<p>Select hosts to display problems of in the widget.</p> <p>Alternatively, select a compatible widget or the dashboard as the data source for hosts.</p> <p>This field is auto-complete, so starting to type the name of a host will offer a dropdown of matching hosts.</p> <p>If no hosts are entered, problems of all hosts will be displayed.</p> <p>This parameter is not available when configuring the widget on a template dashboard.</p>
<i>Problem</i>	<p>You can limit the number of problems displayed by their name.</p> <p>If you enter a string here, only those problems whose name contains the entered string will be displayed.</p> <p>Macros are not expanded.</p>
<i>Severity</i>	<p>Mark problem severities to filter problems to be displayed in the widget.</p> <p>If no severities are marked, all problems will be displayed.</p>
<i>Problem tags</i>	<p>Specify problem tags to limit the number of problems displayed in the widget.</p> <p>It is possible to include as well as exclude specific tags and tag values. Several conditions can be set. Tag name matching is always case-sensitive.</p> <p>There are several operators available for each condition:</p> <ul style="list-style-type: none"> Exists - include the specified tag names; Equals - include the specified tag names and values (case-sensitive); Contains - include the specified tag names where the tag values contain the entered string (substring match, case-insensitive); Does not exist - exclude the specified tag names; Does not equal - exclude the specified tag names and values (case-sensitive); Does not contain - exclude the specified tag names where the tag values contain the entered string (substring match, case-insensitive). <p>There are two calculation types for conditions:</p> <ul style="list-style-type: none"> And/Or - all conditions must be met, conditions having the same tag name will be grouped by the <i>Or</i> condition; Or - enough if one condition is met. <p>When filtered, the tags specified here will be displayed first with the problem, unless overridden by the <i>Tag display priority</i> (see below) list.</p>
<i>Show tags</i>	<p>Select the number of displayed tags:</p> <ul style="list-style-type: none"> None - no <i>Tags</i> column; 1 - <i>Tags</i> column contains one tag; 2 - <i>Tags</i> column contains two tags; 3 - <i>Tags</i> column contains three tags. <p>To see all tags for the problem roll your mouse over the three dots icon.</p>
<i>Tag name</i>	<p>Select tag name display mode:</p> <ul style="list-style-type: none"> Full - tag names and values are displayed in full; Shortened - tag names are shortened to 3 symbols, but tag values are displayed in full; None - only tag values are displayed; no names.
<i>Tag display priority</i>	<p>Enter tag display priority for a problem, as a comma-separated list of tags.</p> <p>Only tag names should be used, no values.</p> <p>Example: <code>Services,Applications,Application</code></p> <p>The tags of this list will always be displayed first, overriding the natural ordering by alphabet.</p>
<i>Show operational data</i>	<p>Select the mode for displaying operational data:</p> <ul style="list-style-type: none"> None - no operational data is displayed; Separately - operational data is displayed in a separate column; With problem name - append operational data to the problem name, using parentheses for the operational data.
<i>Show symptoms</i>	<p>Mark the checkbox to display in its own line problems classified as symptoms.</p>

Show suppressed problems
 Acknowledgement status
 Sort entries by

Mark the checkbox to display problems that would otherwise be suppressed (not shown) because of host maintenance or single **problem suppression**.
 Filter to display all problems, unacknowledged problems only, or acknowledged problems only. Mark the additional checkbox to filter out those problems ever acknowledged by you.
 Sort entries by:
Time (descending or ascending);
Severity (descending or ascending);
Problem name (descending or ascending);
Host (descending or ascending).

Sorting entries by **Host** (descending or ascending) is not available when configuring the widget on a **template dashboard**.

Show timeline
 Show lines

Mark the checkbox to display a visual timeline.
 Specify the number of problem lines to display.

Using the widget

Time	Recovery time	Status	Info	Host	Problem + Severity	Duration	Update	Actions	Tags
04:15:04 PM		PROBLEM		Zabbix server	High memory utilization (>90% for 5m)	7m 41s	Update	[Ack] [Unack]	class: os component: memory scope: capacity ...
03:53:09 PM		PROBLEM		Zabbix server	Load average is too high (per CPU load over 1.5 for 5m)	29m 36s	Update	[Ack] [Unack]	class: os component: cpu scope: capacity ...
07:45:39 AM	07:54:00 AM	RESOLVED		Zabbix server	Zabbix server has been restarted (uptime < 10m)	8m 21s	Update	[Ack] [Unack]	class: os component: system scope: notice ...
2024-10-01 09:43:54 AM	08:43:54 AM	RESOLVED		Zabbix server	Operating system description has changed	23h	Update	[Ack] [Unack]	class: os component: os scope: notice ...
2024-10-01 09:35:00 AM	2024-10-01 09:44:00 AM	RESOLVED		Zabbix server	Zabbix server has been restarted (uptime < 10m)	9m	Update	[Ack] [Unack]	class: os component: system scope: notice ...

Problems widget offers quick access to additional information:

- Click on the problem date and time to view **event details**.
- If Info column is not empty, you can hover over displayed icon to view additional details.
- Click on the host name to open the **host menu**.
- Click on the problem name to open the **event menu**.
- Hover over or click on the problem duration to view **problem event popup**.
- Press on the Yes or No in the Acknowledge (Ack) column to **update a problem**.
- Hover over or press on the gray arrow icon in Actions column to view list of executed actions.

Problem event popup

The problem event popup includes the list of problem events for this trigger and, if defined, the trigger description and a clickable URL.

Time	Info	Host	Problem + Severity	Duration
05/07/2020 11:27:12 AM		Server3	! Disk space is critically low (>90% used)	10m 22d 23h

Time	Status	Duration	Yes/No
04/17/2020 01:07:32 PM	RESOLVED	3d 1h 0m	Yes
04/17/2020 01:05:16 PM	RESOLVED	3d 1h 8m	Yes
04/17/2020 01:02:34 PM	RESOLVED	3d 1h 11m	Yes
04/17/2020 12:47:56 PM	RESOLVED	3d 1h 26m	Yes
04/17/2020 12:45:48 PM	RESOLVED	3d 1h 28m	Yes

To bring up the problem event popup:

- Roll a mouse over the problem duration in the *Duration* column of the *Problems* widget. The popup disappears once you remove the mouse from the duration.
- Click on the duration in the *Duration* column of the *Problems* widget. The popup disappears only if you click on the duration again.

23 Problems by severity

Overview

In this widget, you can display the problem count by severity. You can limit what hosts and triggers are displayed in the widget and define how the problem count is displayed.

The problem count is displayed only for cause problems.

Configuration

To configure, select *Problems by severity* as type:

The screenshot shows the 'Add widget' configuration window. The 'Type' is set to 'Problems by severity'. The 'Name' is 'default'. The 'Refresh interval' is 'Default (1 minute)'. There are search fields for 'Host groups', 'Exclude host groups', and 'Hosts', each with a 'Select' button. The 'Problem' field is empty. Under 'Severity', there are checkboxes for 'Not classified', 'Warning', 'High', 'Information', 'Average', and 'Disaster'. The 'Problem tags' section has 'And/Or' and 'Or' buttons, a search field with 'tag', a dropdown with 'Contains', a search field with 'value', and a 'Remove' link. Below that is an 'Add' link. The 'Show' section has 'Host groups' and 'Totals' buttons. The 'Layout' section has 'Horizontal' and 'Vertical' buttons. The 'Show operational data' section has 'None', 'Separately', and 'With problem name' buttons. There are checkboxes for 'Show suppressed problems' and 'Hide groups without problems'. The 'Problem display' section has 'All', 'Separated', and 'Unacknowledged only' buttons. The 'Show timeline' checkbox is checked. At the bottom right are 'Add' and 'Cancel' buttons.

In addition to the parameters that are **common** for all widgets, you may set the following specific options:

<p><i>Host groups</i></p>	<p>Select host groups to display in the widget. Alternatively, select a compatible widget as the data source for host groups. This field is auto-complete, so starting to type the name of a group will offer a dropdown of matching groups. Specifying a parent host group implicitly selects all nested host groups. Host data from these host groups will be displayed in the widget; if no host groups are entered, all host groups will be displayed.</p>
<p><i>Exclude host groups</i></p>	<p>This parameter is not available when configuring the widget on a template dashboard. Select host groups to hide from the widget. This field is auto-complete, so starting to type the name of a group will offer a dropdown of matching groups. Specifying a parent host group implicitly selects all nested host groups. Host data from these host groups will not be displayed in the widget. For example, hosts 001, 002, 003 may be in Group A and hosts 002, 003 in Group B as well. If we select to <i>show</i> Group A and <i>exclude</i> Group B at the same time, only data from host 001 will be displayed in the dashboard. This parameter is not available when configuring the widget on a template dashboard.</p>

<i>Hosts</i>	<p>Select hosts to display in the widget.</p> <p>Alternatively, select a compatible widget or the dashboard as the data source for hosts. This field is auto-complete, so starting to type the name of a host will offer a dropdown of matching hosts.</p> <p>If no hosts are entered, all hosts will be displayed.</p> <p>This parameter is not available when configuring the widget on a template dashboard.</p>
<i>Problem</i>	<p>You can limit the number of problem hosts displayed by the problem name.</p> <p>If you enter a string here, only those hosts with problems whose name contains the entered string will be displayed.</p> <p>Macros are not expanded.</p>
<i>Severity</i>	<p>Mark problem severities to filter problems to be displayed in the widget.</p> <p>If no severities are marked, all problems will be displayed.</p>
<i>Problem tags</i>	<p>Specify problem tags to limit the number of problems displayed in the widget.</p> <p>It is possible to include as well as exclude specific tags and tag values. Several conditions can be set. Tag name matching is always case-sensitive.</p> <p>There are several operators available for each condition:</p> <p>Exists - include the specified tag names;</p> <p>Equals - include the specified tag names and values (case-sensitive);</p> <p>Contains - include the specified tag names where the tag values contain the entered string (substring match, case-insensitive);</p> <p>Does not exist - exclude the specified tag names;</p> <p>Does not equal - exclude the specified tag names and values (case-sensitive);</p> <p>Does not contain - exclude the specified tag names where the tag values contain the entered string (substring match, case-insensitive).</p> <p>There are two calculation types for conditions:</p> <p>And/Or - all conditions must be met, conditions having the same tag name will be grouped by the <i>Or</i> condition;</p> <p>Or - enough if one condition is met.</p>
<i>Show</i>	<p>Select the show option:</p> <p>Host groups - display problems per host group;</p> <p>Totals - display a problem total for all selected host groups in colored blocks corresponding to the problem severity.</p> <p>This parameter is not available when configuring the widget on a template dashboard, and only a problem total will be displayed.</p>
<i>Layout</i>	<p>Select the layout option:</p> <p>Horizontal - colored blocks of totals will be displayed horizontally;</p> <p>Vertical - colored blocks of totals will be displayed vertically.</p> <p>This parameter is available if <i>Show</i> is set to "Totals".</p>
<i>Show suppressed problems</i>	<p>Mark the checkbox to display problems that would otherwise be suppressed (not shown) because of host maintenance.</p>
<i>Hide groups without problems</i>	<p>Mark the <i>Hide groups without problems</i> option to hide data from host groups without problems in the widget.</p> <p>This parameter is not available when configuring the widget on a template dashboard.</p>
<i>Show operational data</i>	<p>Mark the checkbox to display operational data (see description of Operational data in <i>Monitoring</i> → <i>Problems</i>).</p>
<i>Problem display</i>	<p>Display problem count as:</p> <p>All - full problem count will be displayed;</p> <p>Separated - unacknowledged problem count will be displayed separated as a number of the total problem count;</p> <p>Unacknowledged only - only the unacknowledged problem count will be displayed.</p>
<i>Show timeline</i>	<p>Mark the checkbox to display a visual timeline.</p>

24 SLA report

Overview

This widget is useful for displaying **SLA reports**. Functionally it is similar to the *Services* -> *SLA report* section.

Configuration

To configure, select *SLA report* as type:

Edit widget

Type Show header

Name

Refresh interval

* SLA

Service

Show periods

From

To

In addition to the parameters that are **common** for all widgets, you may set the following specific options:

<i>SLA</i>	Select the SLA for the report.
<i>Service</i>	Select the service for the report.
<i>Show periods</i>	Set how many periods will be displayed in the widget (20 by default, 100 maximum).
<i>From</i>	Select the beginning date for the report. Relative dates are supported: <code>now</code> , <code>now/d</code> , <code>now/w-1w</code> etc; supported date modifiers: <code>d</code> , <code>w</code> , <code>M</code> , <code>y</code> .
<i>To</i>	Select the end date for the report. Relative dates are supported: <code>now</code> , <code>now/d</code> , <code>now/w-1w</code> etc; supported date modifiers: <code>d</code> , <code>w</code> , <code>M</code> , <code>y</code> .

25 System information

Overview

This widget displays the same information as in *Reports* → *System information*, however, a single dashboard widget can only display either the system stats or the high availability nodes at a time (not both).

Configuration

To configure, select *System information* as type:

Add widget ? X

Type System information Show header

Name System information

Refresh interval Default (15 minutes)

Show System stats High availability nodes

Add Cancel

In addition to the parameters that are **common** for all widgets, you may set the following specific options:

-
- Show** Select what to display:
System stats - display a summary of key Zabbix server and system data;
High availability nodes - display the status of high availability nodes (if **high availability cluster** is enabled).
 - Show software update check details** Mark the checkbox to display Zabbix software update check details.
 This option is only available if software update check is enabled in Zabbix server **configuration** and "System stats" is selected in the **Show** field.
-

26 Top hosts

Overview

The Top hosts widget provides a way to create custom tables for displaying data for multiple hosts and can be utilized for creating *Top N*-like reports and progress-bar reports useful for capacity planning. The type of data to display is customizable and can include CPU usage, memory availability, or any other collected values in the numeric, text, or binary format, as well as static text strings. Data can be presented in various formats such as bars, indicators, or sparkline charts.

The maximum number of hosts that can be displayed is 1000.

Top hosts by available memory % ⚙️ ⋮						
Host	Available memory	Available memory in %	Load avg	Contact		
Server node 1	<div style="width: 73.3%; background-color: #00a651; height: 10px;"></div> 7.33 GB	<div style="width: 95%; background-color: #00a651; height: 10px;"></div> 95 %		0.86	admin@company.com	
Zabbix server	<div style="width: 66.6%; background-color: #00a651; height: 10px;"></div> 6.66 GB	<div style="width: 86%; background-color: #00a651; height: 10px;"></div> 86 %		0.86	admin@company.com	
Server node 2	<div style="width: 33.4%; background-color: #00a651; height: 10px;"></div> 3.34 GB	<div style="width: 43%; background-color: #00a651; height: 10px;"></div> 43 %		1.29	admin@company.com	
Web server	<div style="width: 20%; background-color: #ffc107; height: 10px;"></div> 2.00 GB	<div style="width: 26%; background-color: #ffc107; height: 10px;"></div> 26 %		1.58	web_service@company.com	
Virtual machine 2	<div style="width: 13.3%; background-color: #ffc107; height: 10px;"></div> 1.33 GB	<div style="width: 13%; background-color: #ffc107; height: 10px;"></div> 13 %		0.86	vm_admin@company.com	
Virtual machine 1	<div style="width: 0.88%; background-color: #ffc107; height: 10px;"></div> 681.99 MB	<div style="width: 9%; background-color: #ffc107; height: 10px;"></div> 9 %		1.46	vm_admin@company.com	

Key statistics		
Name	Space utilization	CPU
Zabbix server	<div style="width: 95.8489%; background-color: #dc3545; height: 15px;"></div> 95.8489 %	<div style="width: 1.77%; background-color: #6c757d; height: 15px;"></div> 1.77

Configuration

To configure, select *Top hosts* as type:

The screenshot shows the 'Add widget' configuration window. The 'Type' is set to 'Top hosts' and 'Show header' is checked. The 'Name' field contains 'default'. The 'Refresh interval' is set to 'Default (1 minute)'. There are search fields for 'Host groups' and 'Hosts', both with 'Select' dropdowns. The 'Host tags' section has 'And/Or' selected, and a condition is set to 'tag Contains value' with an 'Add' link below it. The 'Show hosts in maintenance' checkbox is unchecked. The '* Columns' section shows a table with columns 'Name', 'Data', and 'Action', with an 'Add' link below. The '* Order by' section is set to 'Add a column'. The 'Order' is set to 'Top N' and the '* Host limit' is set to '10'. 'Add' and 'Cancel' buttons are at the bottom right.

In addition to the parameters that are **common** for all widgets, you may set the following specific options:

<i>Host groups</i>	<p>Select host groups to display in the widget. Alternatively, select a compatible widget as the data source for host groups. This field is auto-complete, so starting to type the name of a group will offer a dropdown of matching groups.</p>
<i>Hosts</i>	<p>This parameter is not available when configuring the widget on a template dashboard. Select hosts to display in the widget. Alternatively, select a compatible widget or the dashboard as the data source for hosts. This field is auto-complete, so starting to type the name of a host will offer a dropdown of matching hosts.</p>
<i>Host tags</i>	<p>This parameter is not available when configuring the widget on a template dashboard. Specify tags to limit the number of hosts displayed in the widget. It is possible to include as well as exclude specific tags and tag values. Several conditions can be set. Tag name matching is always case-sensitive.</p> <p>There are several operators available for each condition: Exists - include the specified tag names; Equals - include the specified tag names and values (case-sensitive); Contains - include the specified tag names where the tag values contain the entered string (substring match, case-insensitive); Does not exist - exclude the specified tag names; Does not equal - exclude the specified tag names and values (case-sensitive); Does not contain - exclude the specified tag names where the tag values contain the entered string (substring match, case-insensitive).</p> <p>There are two calculation types for conditions: And/Or - all conditions must be met, conditions having the same tag name will be grouped by the Or condition; Or - enough if one condition is met.</p> <p>This parameter is not available when configuring the widget on a template dashboard.</p>

<i>Show hosts in maintenance</i>	Mark this checkbox for hosts in maintenance to be displayed as well (in this case, maintenance icon will be shown next to the host name). Unmarked by default.
<i>Columns</i>	Add data columns to display. The column order determines their display from left to right. Columns can be reordered by dragging up and down by the handle before the column name.
<i>Order by</i>	Specify the column from the defined <i>Columns</i> list to use for <i>Top N</i> or <i>Bottom N</i> ordering.
<i>Order</i>	Specify the ordering of rows: Top N - in descending order according to the <i>Order by</i> aggregated value; Bottom N - in ascending order according to the <i>Order by</i> aggregated value.
<i>Host limit</i>	Number of host rows to be shown (1-1000). This parameter is not available when configuring the widget on a template dashboard .

Column configuration

It is possible to add columns of three data types: **host name**, **item value**, or **text**. The list of available column parameters depends on the column data type and, for the item value type, on the value format.

Host name column

Host name column is used to display the name of the host.

Supported parameters:

<i>Name</i>	Name of the column.
<i>Data</i>	Data type to display in the column, select Host name .
<i>Base color</i>	Background color of the column.

Text column

Text column is used to display any specified text string.

Supported parameters:

<i>Name</i>	Name of the column.
<i>Data</i>	Data type to display in the column, select Text .
<i>Base color</i>	Background color of the column.
<i>Text</i>	Enter the string to display. May contain host and inventory macros .

Item value column

Item value column is used to display value of the specified item; it supports multiple value display formats and options.

Supported parameters:

<i>Name</i>	Name of the column.
<i>Data</i>	Data type to display in the column, select Item value .
<i>Item name</i>	Select the item. When configuring the widget on a template dashboard , only items configured on the template can be selected.
<i>Base color</i>	Background color of the column; fill color if <i>Item value</i> data is displayed as bar/indicators. The default color can be overridden by custom color, if the item value is over one of the specified thresholds.
<i>Display item value as</i>	Format for displaying the item value: Numeric , Text , or Binary . The selected option determines which additional parameters will be available. Refer to the parameter list for each format below.

Advanced configuration**Aggregation function**

Specify which aggregation function to use:

- min** - display the smallest value;
- max** - display the largest value;
- avg** - display the average value;
- count** - display the count of values;
- sum** - display the sum of values;
- first** - display the first value;
- last** - display the last value;
- not used** - display the most recent value (no aggregation).

Aggregation allows to display an aggregated value for the chosen interval (5 minutes, an hour, a day), instead of the most recent value.

Only numeric data can be displayed for *min*, *max*, *avg* and *sum*. For *count*, non-numeric data will be changed to numeric.

Time period

Specify the time period to use for aggregating values:

- Dashboard** - use time period of the dashboard;
- Widget** - use time period of the specified widget;
- Custom** - use a custom time period.

This parameter will not be displayed if *Aggregation function* is set to "not used".

Widget

Select the widget.

This parameter will only be displayed if *Time period* is set to "Widget".

From

Select the time period from (default value `now-1h`). See [relative time syntax](#).

This parameter will only be displayed if *Time period* is set to "Custom".

To

Select the time period to (default value `now`). See [relative time syntax](#).

This parameter will only be displayed if *Time period* is set to "Custom".

History data

Take data from history or trends:

- Auto** - automatic selection;
- History** - take history data;
- Trends** - take trend data.

This parameter is available only for numeric item values. For text and binary values data will always be taken from history.

Numeric item value parameters:

Display

Define how the value should be displayed:

- As is** - as regular text;
- Bar** - as solid, color-filled bar;
- Indicators** - as segmented, color-filled bar;
- Sparkline** - mini line graph.

Thresholds

Specify threshold values when the background/fill color should change.

The list will be sorted in ascending order when saved.

For sparklines, thresholds are applied only to the item last value.

Decimal places

Specify how many decimal places will be displayed with the value.

Bar/Indicators**Min**

Minimum value.

Max

Maximum value.

Sparkline**Width**

Set the graph line thickness by using the slider or manually entering a value in the range from 0 to 10.

Color

Select line and fill color.

Fill

Set fill color transparency level by using the slider or manually entering a value in the range from 0 to 10.

Time period

Specify the time period for values to be included into the sparkline chart:

- Dashboard** - use time period of the dashboard;
- Widget** - use time period of the specified widget;
- Custom** - use a custom time period.

Note that the time period affects only the sparkline chart. The value displayed next to the sparkline represents the last value of the item, not the last value in the selected time period.

<i>Widget</i>	Select the widget. This parameter will only be displayed if <i>Time period</i> is set to "Widget".
<i>From</i>	Select the time period from (default value now-1h). See relative time syntax . This parameter will only be displayed if <i>Time period</i> is set to "Custom".
<i>To</i>	Select the time period to (default value now). See relative time syntax . This parameter will only be displayed if <i>Time period</i> is set to "Custom".
<i>History data</i>	Take data from history or trends: Auto - automatic selection; History - take history data; Trends - take trend data.

Text item value parameters:

<i>Highlights</i>	Specify the regular expressions upon matching which the background/fill color should change.
-------------------	--

Binary item value parameters:

<i>Show thumbnail</i>	Specify whether to create and display a thumbnail for the image containing binary data or to display a hyperlink <i>Show</i> leading to the full-size image in the value column.
-----------------------	--

27 Top items

Overview

In the *Top items* widget, you can display top (or bottom) values for a group of items.

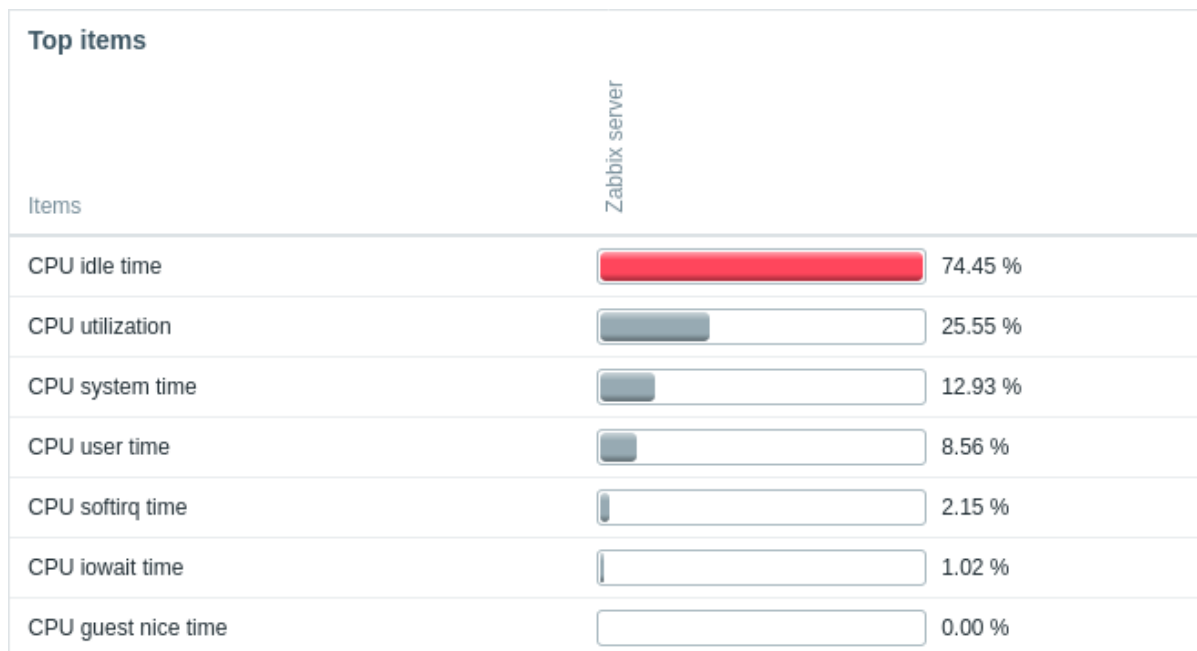

It is possible to select items directly or by pattern, customize column ordering and highlighting.

The color of problem items is based on the problem severity color, which can be adjusted in the [problem update](#) screen.

By default, only values that fall within the last 24 hours are displayed. This limit has been introduced with the aim of improving initial loading times for large pages of latest data. This limit is configurable in *Administration* → *General* → *GUI*, using the *Max history display period* option.

Clicking on item value opens the [item menu](#).

Configuration

To configure, select *Top items* as type:

Add widget
? X

Type

Name

Refresh interval

Host groups

Hosts

Host tags

[Add](#)

Layout

Show problems

* Items

[Add](#)

Show header

Advanced configuration

Host ordering

* Order by

Order

* Limit

Item ordering

* Order by

Order

* Limit

Show column header

In addition to the parameters that are **common** for all widgets, you may set the following specific options:

<i>Host groups</i>	<p>Select host groups.</p> <p>Alternatively, select a compatible widget as the data source for host groups.</p> <p>This field is auto-complete so starting to type the name of a group will offer a dropdown of matching groups.</p>
<i>Hosts</i>	<p>This parameter is not available when configuring the widget on a template dashboard.</p> <p>Select hosts.</p> <p>Alternatively, select a compatible widget or the dashboard as the data source for hosts.</p> <p>This field is auto-complete so starting to type the name of a host will offer a dropdown of matching hosts.</p> <p>This parameter is not available when configuring the widget on a template dashboard.</p>

Host tags	<p>Specify tags to limit the number of host data displayed in the widget. It is possible to include as well as exclude specific tags and tag values. Several conditions can be set. Tag name matching is always case-sensitive.</p> <p>There are several operators available for each condition:</p> <p>Exists - include the specified tag names;</p> <p>Equals - include the specified tag names and values (case-sensitive);</p> <p>Contains - include the specified tag names where the tag values contain the entered string (substring match, case-insensitive);</p> <p>Does not exist - exclude the specified tag names;</p> <p>Does not equal - exclude the specified tag names and values (case-sensitive);</p> <p>Does not contain - exclude the specified tag names where the tag values contain the entered string (substring match, case-insensitive).</p> <p>There are two calculation types for conditions:</p> <p>And/Or - all conditions must be met, conditions having the same tag name will be grouped by the <i>Or</i> condition;</p> <p>Or - enough if one condition is met.</p>
Layout	<p>Select the layout option:</p> <p>Horizontal - host names will be displayed on the left;</p> <p>Vertical - host names will be displayed at the top.</p>
Show problems	<p>Select how to display problems:</p> <p>All - display all problems;</p> <p>Unsuppressed - only display problems that are not suppressed due to host maintenance;</p> <p>None - do not display problems at all.</p> <p><i>Note</i> that when a problem state is represented, it overrides the display style settings from item column configuration.</p>
Items	<p>Add item patterns or specific items for display (see Column configuration).</p>
Advanced configuration	
Host ordering	<p>Select ordering options for the host column/row.</p>
Order by	<p>Order hosts by:</p> <p>Host name - hosts will be ordered by host name;</p> <p>Item value - hosts will be ordered by the value of selected items.</p>
Order	<p>Select whether to display the highest or lowest values:</p> <p>TopN - top N values;</p> <p>BottomN - bottom N values.</p>
Limit	<p>The value of N is selected in the <i>Limit</i> field.</p> <p>Enter limit for displayable hosts (range 1-1000; default 10). This value will become the value of N in the <i>Order</i> field.</p>
Item ordering	<p>Select ordering options for the item column/row.</p>
Order by	<p>Order items by:</p> <p>Item value - items will be ordered by item value;</p> <p>Item name - items will be ordered by item name;</p> <p>Host - items will be ordered by the selected host pattern.</p>
Order	<p>Select whether to display the highest or lowest values:</p> <p>TopN - top N values;</p> <p>BottomN - bottom N values.</p>
Limit	<p>The value of N is selected in the <i>Limit</i> field.</p> <p>Enter limit for displayable items (range 1-1000; default 10). This value will become the value of N in the <i>Order</i> field.</p>

Show
col-
umn
header

Select column header display options:
Off - do not display column header;
Horizontal - display text horizontally in the header;
Vertical - display text vertically in the header.

Column configuration

To configure item columns, click *Add* in the *Items* parameter:

The 'New column' dialog box contains the following configuration options:

- Item patterns:** A text input field containing 'CPU* x' with a close icon, and a 'Select' button below it.
- Item tags:** Radio buttons for 'And/Or' (selected) and 'Or'. Below is a 'tag' input field, a 'Contains' dropdown menu, a 'value' input field, and a 'Remove' link.
- Base color:** A color selection box showing a red diagonal line.
- Display value as:** Radio buttons for 'Numeric' (selected) and 'Text'.
- Display:** Radio buttons for 'As is', 'Bar' (selected), 'Indicators', and 'Sparkline'.
- Min:** An input field containing 'calculated'.
- Max:** An input field containing 'calculated'.
- Thresholds:** A table with a 'Threshold' header, a red color swatch, an input field with '70', and a 'Remove' link. An 'Add' link is below the table.
- Decimal places:** An input field containing '2'.
- Advanced configuration:** A section with an upward arrow icon, containing:
 - Aggregation function:** A dropdown menu with 'not used' selected.
 - History data:** Radio buttons for 'Auto' (selected), 'History', and 'Trends'.

At the bottom right, there are 'Add' and 'Cancel' buttons.

Common column parameters:

Item patterns

Specify one or several item patterns, using the wildcard character. Alternatively, select the items. When configuring the widget on a **template dashboard**, only **items configured on the template** can be selected.

<i>Item tags</i>	<p>Specify tags to limit the number of item data displayed in the widget. It is possible to include as well as exclude specific tags and tag values. Several conditions can be set. Tag name matching is always case-sensitive.</p> <p>There are several operators available for each condition:</p> <p>Exists - include the specified tag names;</p> <p>Equals - include the specified tag names and values (case-sensitive);</p> <p>Contains - include the specified tag names where the tag values contain the entered string (substring match, case-insensitive);</p> <p>Does not exist - exclude the specified tag names;</p> <p>Does not equal - exclude the specified tag names and values (case-sensitive);</p> <p>Does not contain - exclude the specified tag names where the tag values contain the entered string (substring match, case-insensitive).</p> <p>There are two calculation types for conditions:</p> <p>And/Or - all conditions must be met, conditions having the same tag name will be grouped by the <i>Or</i> condition;</p> <p>Or - enough if one condition is met.</p>
<i>Base color</i>	Select the column's background color or fill color if <i>Display</i> is set to "Bar" or "Indicators". Note that the base color can be overridden by threshold or highlight colors.
<i>Display value as</i>	<p>Format for displaying the item value: Numeric or Text.</p> <p>The selected option determines which additional parameters will be available. Refer to the parameter list for each format below.</p>

Column parameters for numeric values:

<i>Display</i>	<p>Define how the value should be displayed:</p> <p>As is - as regular text;</p> <p>Bar - as solid, color-filled bar;</p> <p>Indicators - as segmented, color-filled bar;</p> <p>Sparkline - mini line graph.</p>
<i>Min</i>	Minimum value for bar/indicators display.
<i>Max</i>	Maximum value for bar/indicators display.
<i>Width</i>	Set the graph line thickness by using the slider or manually entering a value in the range from 0 to 10.
<i>Fill</i>	<p>This parameter is for sparkline display only.</p> <p>Set fill color transparency level by using the slider or manually entering a value in the range from 0 to 10.</p>
<i>Color</i>	<p>This parameter is for sparkline display only.</p> <p>Select line and fill color.</p> <p>This parameter is for sparkline display only.</p>
<i>See Advanced configuration for description of fields related to time period and history data selection.</i>	
<i>Thresholds</i>	<p>Specify threshold values when the background/fill color should change. The list will be sorted in ascending order when saved.</p> <p>For sparklines, thresholds are applied only to the item last value.</p>
<i>Decimal places</i>	Specify how many decimal places will be displayed with the value.

Advanced configuration

<i>Aggregation function</i>	<p>Specify which aggregation function to use:</p> <ul style="list-style-type: none"> min - display the smallest value; max - display the largest value; avg - display the average value; count - display the count of values; sum - display the sum of values; first - display the first value; last - display the last value; not used - display the most recent value (no aggregation). <p>Aggregation allows to display an aggregated value for the chosen interval (5 minutes, an hour, a day), instead of the most recent value.</p> <p>Only numeric data can be displayed for <i>min</i>, <i>max</i>, <i>avg</i> and <i>sum</i>. For <i>count</i>, non-numeric data will be changed to numeric.</p>
<i>Time period</i>	<p>Specify the time period to use for aggregating values:</p> <ul style="list-style-type: none"> Dashboard - use time period of the dashboard; Widget - use time period of the specified widget; Custom - use a custom time period. <p>This parameter will not be displayed if <i>Aggregation function</i> is set to "not used".</p>
<i>Widget</i>	<p>Select the widget.</p> <p>This parameter will only be displayed if <i>Time period</i> is set to "Widget".</p>
<i>From</i>	<p>Select the time period from (default value <code>now-1h</code>). See relative time syntax.</p> <p>This parameter will only be displayed if <i>Time period</i> is set to "Custom".</p>
<i>To</i>	<p>Select the time period to (default value <code>now</code>). See relative time syntax.</p> <p>This parameter will only be displayed if <i>Time period</i> is set to "Custom".</p>
<i>History data</i>	<p>Take data from history or trends:</p> <ul style="list-style-type: none"> Auto - automatic selection; History - take history data; Trends - take trend data. <p>This parameter is available only for numeric item values. For text values data will always be taken from history.</p>

Column parameters for text values:

<i>Highlights</i>	Specify the regular expressions upon matching which the background/fill color should change.
-------------------	--

28 Top triggers

Overview

In the *Top triggers* widget, you can see the triggers with the highest number of problems.

Top triggers			
Host	Trigger	Severity	Number of problems
Zabbix server	Interface enp0s3: Link down	Average	2
Zabbix server	Load average is too high	Average	2
Zabbix server	Zabbix agent is not available	Average	2
Zabbix server	Zabbix server: More than 100 items having missing data for more than 10 minutes	Warning	2
Zabbix server	Zabbix server: Utilization of escalator processes is high	Average	2

The maximum number of triggers that can be shown is 1000. When viewing the widget on a dashboard, it is possible to select the time period for displaying the data.

The information on top triggers is also available in the *Reports* → *Top 100 triggers* menu section.

Configuration

To configure, select *Top triggers* as widget type:

Add widget
? X

Type

Name

Refresh interval

Host groups Select
type here to search

Hosts Select

Problem

Severity
 Not classified
 Warning
 High
 Information
 Average
 Disaster

Problem tags

Time period

* Trigger limit

Show header

In addition to the parameters that are **common** for all widgets, you may set the following specific options:

<i>Host groups</i>	<p>Select host groups to display problems of in the widget.</p> <p>This field is auto-complete, so starting to type the name of a group will offer a dropdown of matching groups.</p> <p>Specifying a parent host group implicitly selects all nested host groups.</p> <p>Problems from these host groups will be displayed in the widget; if no host groups are entered, problems from all host groups will be displayed.</p>
<i>Hosts</i>	<p>This parameter is not available when configuring the widget on a template dashboard.</p> <p>Select hosts to display problems of in the widget.</p> <p>This field is auto-complete, so starting to type the name of a host will offer a dropdown of matching hosts.</p> <p>If no hosts are entered, problems of all hosts will be displayed.</p>
<i>Problem</i>	<p>This parameter is not available when configuring the widget on a template dashboard.</p> <p>You can view the triggers for particular problems only. For this, enter the string to be matched in the problem name.</p> <p>Macros are not expanded.</p>
<i>Severity</i>	<p>Mark trigger severities to filter triggers to be displayed in the widget.</p> <p>If no severities are marked, all triggers will be displayed.</p>

792

<i>Problem tags</i>	<p>Specify the tags of the problems to be displayed in the widget. It is possible to include as well as exclude specific tags and tag values. Several conditions can be set. Tag name matching is always case-sensitive.</p> <p>There are several operators available for each condition:</p> <p>Exists - include the specified tag names;</p> <p>Equals - include the specified tag names and values (case-sensitive);</p> <p>Contains - include the specified tag names where the tag values contain the entered string (substring match, case-insensitive);</p> <p>Does not exist - exclude the specified tag names;</p> <p>Does not equal - exclude the specified tag names and values (case-sensitive);</p> <p>Does not contain - exclude the specified tag names where the tag values contain the entered string (substring match, case-insensitive).</p> <p>There are two calculation types for conditions:</p> <p>And/Or - all conditions must be met, conditions having the same tag name will be grouped by the <i>Or</i> condition;</p> <p>Or - enough if one condition is met.</p>
<i>Time period</i>	<p>Select the data source for the time period:</p> <p>Dashboard - set the <i>Time period</i> selector as the data source;</p> <p>Widget - set a compatible widget specified in the <i>Widget</i> parameter as the data source;</p> <p>Custom - set the time period specified in the <i>From</i> and <i>To</i> parameters as the data source; if set, a clock icon will be displayed in the top right corner of the widget, indicating the set time on mouseover.</p>
<i>Widget</i>	<p>Enter or select a compatible widget (<i>Graph</i>, <i>Graph (classic)</i>, <i>Graph prototype</i>) as the data source for the time period.</p>
<i>From</i>	<p>This parameter is available if <i>Time period</i> is set to "Widget".</p> <p>Enter or select the start of the time period.</p> <p>Relative time syntax (<code>now</code>, <code>now/d</code>, <code>now/w-1w</code>, etc.) is supported.</p>
<i>To</i>	<p>This parameter is available if <i>Time period</i> is set to "Custom".</p> <p>Enter or select the end of the time period.</p> <p>Relative time syntax (<code>now</code>, <code>now/d</code>, <code>now/w-1w</code>, etc.) is supported.</p>
<i>Trigger limit</i>	<p>This parameter is available if <i>Time period</i> is set to "Custom".</p> <p>Set the number of triggers to be displayed. Possible value range: 1-1000.</p>

29 Trigger overview

Overview

In the trigger overview widget, you can display the trigger states for a group of hosts.

- The trigger states are displayed as colored blocks (the color of the blocks for PROBLEM triggers depends on the problem severity color, which can be adjusted in the **problem update** screen). Note that recent trigger state changes (within the last 2 minutes) will be displayed as blinking blocks.
- Gray up and down arrows indicate triggers that have dependencies. On mouseover, dependency details are revealed.
- A checkbox icon indicates acknowledged problems. All problems or resolved problems of the trigger must be acknowledged for this icon to be displayed.

Clicking on a trigger block provides context-dependent links to problem events of the trigger, the problem acknowledgment screen, trigger configuration, trigger URL or a simple graph/latest values list.

Note that 50 records are displayed by default (configurable in *Administration* → *General* → *GUI*, using the *Max number of columns and rows in overview tables* option). If more records exist than are configured to display, a message is displayed at the bottom of the table, asking to provide more specific filtering criteria. There is no pagination. Note that this limit is applied first, before any further filtering of data, for example, by tags.

Configuration

To configure, select *Trigger overview* as type:

Add widget
? X

Type

Name

Refresh interval

Show Recent problems Problems Any

Host groups Select

Hosts Select

Problem tags And/Or Or

[Remove](#)

[Add](#)

Show header

Show suppressed problems

Hosts location Left Top

Add
Cancel

In addition to the parameters that are **common** for all widgets, you may set the following specific options:

<i>Show</i>	<p>Filter triggers by trigger state:</p> <p>Recent problems - (<i>default</i>) show triggers that recently have been or still are in a PROBLEM state (resolved and unresolved);</p> <p>Problems - show triggers that are in a PROBLEM state (unresolved);</p> <p>Any - show all triggers.</p>
<i>Host groups</i>	<p>Select host groups.</p> <p>Alternatively, select a compatible widget as the data source for host groups.</p> <p>This field is auto-complete, so starting to type the name of a group will offer a dropdown of matching groups.</p>
<i>Hosts</i>	<p>This parameter is not available when configuring the widget on a template dashboard.</p> <p>Select hosts.</p> <p>Alternatively, select a compatible widget or the dashboard as the data source for hosts.</p> <p>This field is auto-complete, so starting to type the name of a host will offer a dropdown of matching hosts.</p> <p>This parameter is not available when configuring the widget on a template dashboard.</p>

Problem tags

Specify tags to filter the triggers displayed in the widget.

It is possible to include as well as exclude specific tags and tag values. Several conditions can be set. Tag name matching is always case-sensitive.

Note: If the parameter *Show* is set to 'Any', all triggers will be displayed even if tags are specified. However, while recent trigger state changes (displayed as blinking blocks) will update for all triggers, the trigger state details (problem severity color and whether the problem is acknowledged) will only update for triggers that match the specified tags.

There are several operators available for each condition:

Exists - include the specified tag names;

Equals - include the specified tag names and values (case-sensitive);

Contains - include the specified tag names where the tag values contain the entered string (substring match, case-insensitive);

Does not exist - exclude the specified tag names;

Does not equal - exclude the specified tag names and values (case-sensitive);

Does not contain - exclude the specified tag names where the tag values contain the entered string (substring match, case-insensitive).

There are two calculation types for conditions:

And/Or - all conditions must be met, conditions having the same tag name will be grouped by the *Or* condition;

Or - enough if one condition is met.

Show suppressed problems

Mark the checkbox to display problems that would otherwise be suppressed (not shown) because of host maintenance.

Layout

Select the layout option:

Horizontal - host names will be displayed on the left;

Vertical - host names will be displayed at the top.

30 URL

Overview

This widget displays the content retrieved from the specified URL.

Configuration

To configure, select *URL* as type:

The screenshot shows a configuration window titled "Add widget" with a search icon and a close button in the top right corner. The window contains the following fields and controls:

- Type:** A dropdown menu with "URL" selected.
- Show header:** A checkbox that is checked.
- Name:** A text input field containing "URL".
- Refresh interval:** A dropdown menu with "Default (No refresh)" selected.
- * URL:** A text input field containing "http://".
- Override host:** A text input field containing "type here to search" and a "Select" dropdown menu.
- Buttons:** "Add" and "Cancel" buttons at the bottom right.

In addition to the parameters that are **common** for all widgets, you may set the following specific options:

URL	Enter the URL to display (up to 2048 characters). External URLs must start with <code>http://</code> or <code>https://</code> . Internal URLs support relative paths (for example, <code>zabbix.php?action=report.status</code>). {HOST.*} macros are supported.
Override host	Select a compatible widget or the dashboard as the data source for hosts. This parameter is not available when configuring the widget on a template dashboard .

Attention:

Browsers might not load an HTTP page configured in the widget if Zabbix frontend is accessed over HTTPS.

31 Web monitoring

Overview

This widget displays a status summary of the active web monitoring scenarios. See the **Web monitoring widget** section for detailed information.

Configuration

Add widget ? X

Type: Show header

Name:

Refresh interval:

Host groups: Select ▼

Exclude host groups: Select

Hosts: Select ▼

Scenario tags:

Remove

[Add](#)

Show hosts in maintenance

Note:

In cases when a user does not have permission to access certain widget elements, that element's name will appear as *Inaccessible* during the widget's configuration. This results in *Inaccessible Item*, *Inaccessible Host*, *Inaccessible Group*, *Inaccessible Map*, and *Inaccessible Graph* appearing instead of the "real" name of the element.

In addition to the parameters that are **common** for all widgets, you may set the following specific options:

Host groups	Select host groups to display in the widget. Alternatively, select a compatible widget as the data source for host groups. This field is auto-complete, so starting to type the name of a group will offer a dropdown of matching groups. Specifying a parent host group implicitly selects all nested host groups. Host data from these host groups will be displayed in the widget; if no host groups are entered, all host groups will be displayed. This parameter is not available when configuring the widget on a template dashboard .
--------------------	--

<i>Exclude host groups</i>	<p>Select host groups to hide from the widget.</p> <p>This field is auto-complete, so starting to type the name of a group will offer a dropdown of matching groups.</p> <p>Specifying a parent host group implicitly selects all nested host groups.</p> <p>Host data from these host groups will not be displayed in the widget. For example, hosts 001, 002, 003 may be in Group A and hosts 002, 003 in Group B as well. If we select to <i>show</i> Group A and <i>exclude</i> Group B at the same time, only data from host 001 will be displayed in the dashboard.</p> <p>This parameter is not available when configuring the widget on a template dashboard.</p>
<i>Hosts</i>	<p>Select hosts to display in the widget.</p> <p>Alternatively, select a compatible widget or the dashboard as the data source for hosts.</p> <p>This field is auto-complete, so starting to type the name of a host will offer a dropdown of matching hosts.</p> <p>If no hosts are entered, all hosts will be displayed.</p> <p>This parameter is not available when configuring the widget on a template dashboard.</p>
<i>Scenario tags</i>	<p>Specify tags to limit the number of web scenarios displayed in the widget.</p> <p>It is possible to include as well as exclude specific tags and tag values. Several conditions can be set. Tag name matching is always case-sensitive.</p> <p>There are several operators available for each condition:</p> <p>Exists - include the specified tag names;</p> <p>Equals - include the specified tag names and values (case-sensitive);</p> <p>Contains - include the specified tag names where the tag values contain the entered string (substring match, case-insensitive);</p> <p>Does not exist - exclude the specified tag names;</p> <p>Does not equal - exclude the specified tag names and values (case-sensitive);</p> <p>Does not contain - exclude the specified tag names where the tag values contain the entered string (substring match, case-insensitive).</p> <p>There are two calculation types for conditions:</p> <p>And/Or - all conditions must be met, conditions having the same tag name will be grouped by the <i>Or</i> condition;</p> <p>Or - enough if one condition is met.</p>
<i>Show hosts in maintenance</i>	<p>Include hosts that are in maintenance in the statistics.</p> <p>This parameter is labeled <i>Show data in maintenance</i> when configuring the widget on a template dashboard.</p>

Web monitoring widget

Once you have completed the configuration, you might like to see the widget with the data it displays. To do it, go to *Dashboards*, click on the name of a dashboard where you created the widget.

In this example, you can see the widget named "Zabbix frontend" displaying the status of the web monitoring for three host groups: "Internal network," "Linux servers," and "Web servers."

Zabbix frontend

Host group ▲	Ok	Failed	Unknown
Internal network	1		
Linux servers		1	
Web servers			1

A web monitoring widget displays the following information:

- a name of a widget; below it, there are four columns:
 - *Host group* - displays a list of host groups that contain hosts having web scenarios configured;

- *Ok* - displays a number of web scenarios (in green color) when two conditions are observed:
 - * Zabbix has collected the latest data for a web scenario(s);
 - * all steps that were configured in a **web scenario** are in "Ok" *Status*.
- *Failed* - displays a number of web scenarios (in red color), which have some failed steps:
 - * click on the host name, and it will open a new window; the *Status* column provides detailed information (in red color) on the step where Zabbix failed to collect the data; and also,
 - * gives a hint for the parameter that has to be corrected in the **configuration form**.

Web monitoring

Host	Name	Number of steps	Last check	Status	Tags
Internal documentation	Internal Wiki	2	38s	Step "Configuration page" [2 of 2] failed: required pattern "winter" was not found on http://localhost/index.php	

Displaying 1 of 1 found

- *Unknown* - displays a number of web scenarios (in grey color) for which Zabbix has neither collected data, nor has an information about the failed steps.

Web monitoring

Host	Name	Number of steps	Last check	Status	Tags
Zabbix site	Zabbix site	1			

Displaying 1 of 1 found

Viewing the status and data

Clickable links in the widget allow to easily navigate and quickly acquire a full information on each web scenario. Thus, to view:

- the *Status* of a web scenario, click on the name of a host group.
- more detailed statistics, click on the scenario name. In this example it is "Zabbix frontend".
- the details in the case of *Failed* status, click on a host group name; in the window that opens, click on a web scenario name in the *Name* column; it will open more detailed information on the configured steps for which Zabbix failed to collect the data.

Details of web scenario: Internal Wiki

Step	Speed	Response time	Response code	Status
First page	95.94 KBps	256.75ms	200	OK
Configuration page	40.46 KBps	33.5ms	200	Error: required pattern "winter" was not found on http://localhost/index.php
TOTAL		290.25ms		Error: required pattern "winter" was not found on http://localhost/index.php

Now, you can return to the **web scenario configuration form** and correct your settings.

To view the details in the case of *Unknown* status, you can repeat the same steps as explained for *Failed*.

Attention:

At the first monitoring instance, a web scenario is always displayed in *Unknown* state, which is switched to *Failed* or *Ok* state right after the first check. In the case when a host is monitored by the proxy, the status change occurs in accordance with the data collection frequency configured on the proxy.

2 Monitoring

Overview

The Monitoring menu is all about displaying data. Whatever information Zabbix is configured to gather, visualize and act upon, it will be displayed in the various sections of the Monitoring menu.

View mode buttons

The following buttons located in the top right corner are common for every section:



Display page in kiosk mode. In this mode only page content is displayed.



To exit kiosk mode, move the mouse cursor until the exit button appears and click on it. You will be taken back to normal mode.

1 Problems



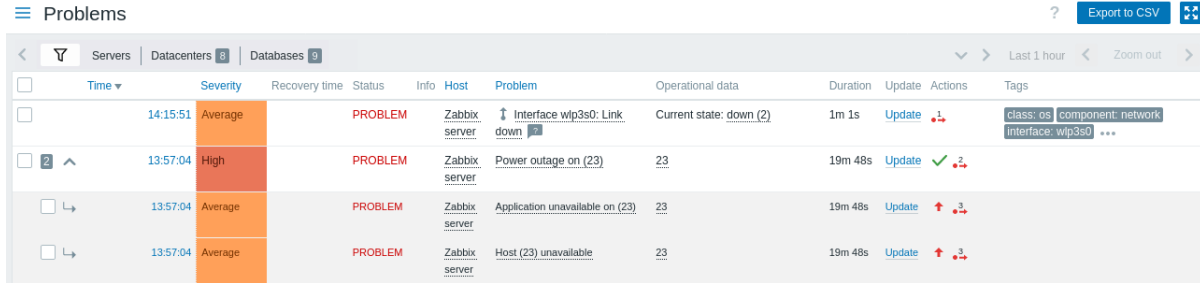

Overview

In *Monitoring* → *Problems* you can see what problems you currently have. Problems are those triggers that are in the "Problem" state.

By default all new problems are classified as cause problems. It is possible to manually reclassify certain problems as symptom problem of the cause problem. For more details, see [cause and symptom events](#).



Column	Description
--------	-------------

Checkbox
 Checkboxes for problem selection are displayed. Icons, next to the checkboxes, have the following meaning:
 - the number of symptom events for the cause problem;
 - expand to show symptom events;
 - collapse to hide symptom events;
 - this is a symptom event.

Time
 Problem start time is displayed.

Severity
 Problem severity is displayed. Problem severity is originally based on the severity of the underlying problem trigger, however, after the event has happened it can be updated using the *Update problem screen*. Color of the problem severity is used as cell background during problem time.

Recovery time
 Problem resolution time is displayed.

Status
 Problem status is displayed:
Problem - unresolved problem
Resolved - recently resolved problem. You can hide recently resolved problems using the filter. New and recently resolved problems blink for 2 minutes. Resolved problems are displayed for 5 minutes in total. Both of these values are configurable in *Administration* → *General* → *Trigger displaying options*.



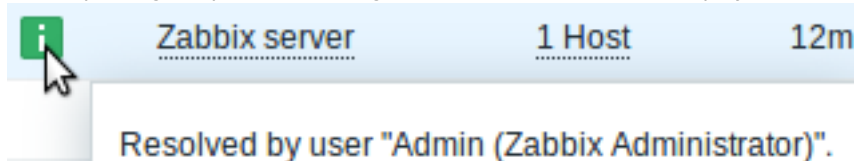



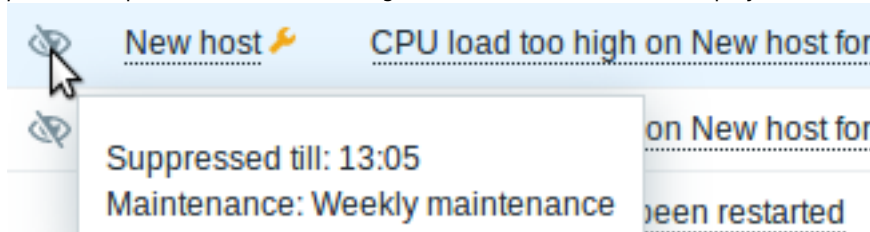

Info
 A green information icon is displayed if a problem is closed by global correlation or manually when updating the problem. Rolling a mouse over the icon will display more details:



The following icon is displayed if a suppressed problem is being shown (see *Show suppressed problems* option in the filter). Rolling a mouse over the icon will display more details:



Host
 Problem host is displayed. Clicking on the host name brings up the **host menu**.

Column	Description
<i>Problem</i>	<p>Problem name is displayed.</p> <p>Problem name is based on the name of the underlying problem trigger.</p> <p>Macros in the trigger name are resolved at the time of the problem happening and the resolved values do not update any more.</p> <p><i>Note</i> that it is possible to append the problem name with operational data showing some latest item values.</p> <p>Clicking on the problem name brings up the event menu.</p> <p>Hovering on the  icon after the problem name will bring up the trigger description (for those problems that have it).</p>
<i>Operational data</i>	<p>Operational data are displayed containing latest item values.</p> <p>Operational data can be a combination of text and item value macros if configured on a trigger level. If no operational data is configured on a trigger level, the latest values of all items from the expression are displayed.</p> <p>This column is only displayed if <i>Separately</i> is selected for <i>Show operational data</i> in the filter.</p>
<i>Duration</i>	<p>Problem duration is displayed.</p> <p>See also: Negative problem duration</p>
<i>Update</i>	<p>Click on the <i>Update</i> link to go to the problem update screen where various actions can be taken on the problem, including commenting and acknowledging the problem.</p>
<i>Actions</i>	<p>History of activities about the problem is displayed using symbolic icons:</p> <ul style="list-style-type: none">  - problem has been acknowledged. This icon is always displayed first.  - comments have been made. The number of comments is also displayed.  - problem severity has been increased (e.g. Information → Warning)  - problem severity has been decreased (e.g. Warning → Information)  - problem severity has been changed, but returned to the original level (e.g. Warning → Information → Warning)  - actions have been taken. The number of actions is also displayed.  - actions have been taken, at least one is in progress. The number of actions is also displayed.  - actions have been taken, at least one has failed. The number of actions is also displayed. <p>When rolling the mouse over the icons, popups with details about the activity are displayed. See viewing details to learn more about icons used in the popup for actions taken.</p>
<i>Tags</i>	<p>Tags are displayed (if any).</p> <p>In addition, tags from an external ticketing system may also be displayed (see the <i>Process tags</i> option when configuring webhooks).</p>

Operational data of problems

It is possible to display operational data for current problems, i.e. the latest item values as opposed to the item values at the time of the problem.

Operational data display can be configured in the filter of *Monitoring* → *Problems* or in the configuration of the respective **dashboard widget**, by selecting one of the three options:

- *None* - no operational data is displayed
- *Separately* - operational data is displayed in a separate column

Time	<input type="checkbox"/> Severity	Recovery time	Status	Info	Host ▲	Problem	Operational data	Duration
09:28:35	<input type="checkbox"/> Average		PROBLEM		Zabbix server	Zabbix discoverer processes more than 75% busy	Current value: 100 %	3h 32m 8s

- *With problem name* - operational data is appended to the problem name and in parentheses. Operational data are appended to the problem name only if the *Operational data* field is non-empty in the trigger configuration.

Time	<input type="checkbox"/> Severity	Recovery time	Status	Info	Host ▲	Problem	Duration
09:28:35	<input type="checkbox"/> Average		PROBLEM		Zabbix server	Zabbix discoverer processes more than 75% busy Current value: 100 %	3h 29m 34s

The content of operational data can be configured with each **trigger**, in the *Operational data* field. This field accepts an arbitrary string with macros, most importantly, the `{ITEM.LASTVALUE<1-9>}` macro.

`{ITEM.LASTVALUE<1-9>}` in this field will always resolve to the latest values of items in the trigger expression. `{ITEM.VALUE<1-9>}` in this field will resolve to the item values at the moment of trigger status change (i.e. change into problem, change into OK, being closed manually by a user or being closed by correlation).

Note that closing the problem manually does not produce a new value so the resolved value of `{ITEM.LASTVALUE<1-9>}` or `{ITEM.VALUE<1-9>}` will still show the value from the problem time.

`{ITEM.LASTVALUE<1-9>}` or `{ITEM.VALUE<1-9>}` will resolve to `*UNKNOWN*` if the latest history value has been collected more than the *Max history display period* time ago (see [Administration → General](#)).

Negative problem duration

It is actually possible in some common situations to have negative problem duration i.e. when the problem resolution time is earlier than problem creation time, e. g.:

- If some host is monitored by proxy and a network error happens, leading to no data received from the proxy for a while, the `nodata(/host/key)` trigger will be fired by the server. When the connection is restored, the server will receive item data from the proxy having a time from the past. Then, the `nodata(/host/key)` problem will be resolved and it will have a negative problem duration;
- When item data that resolve the problem event are sent by Zabbix sender and contain a timestamp earlier than the problem creation time, a negative problem duration will also be displayed.

Note:

Negative problem duration is not affecting **SLA calculation** or **Availability report** of a particular trigger in any way; it neither reduces nor expands problem time.

Mass editing options

Buttons below the list offer some mass-editing options:

- *Mass update* - update the selected problems by navigating to the **problem update** screen

To use this option, mark the checkboxes before the respective problems, then click on the *Mass update* button.

Buttons

The button to the right offers the following option:



View mode buttons, being common for all sections, are described on the **Monitoring** page.

Using filter

You can use the filter to display only the problems you are interested in. For better search performance, data is searched with macros unresolved.

The filter is located above the table. Favorite filter settings can be saved as tabs and then quickly accessed by clicking on the **tabs above the filter**.

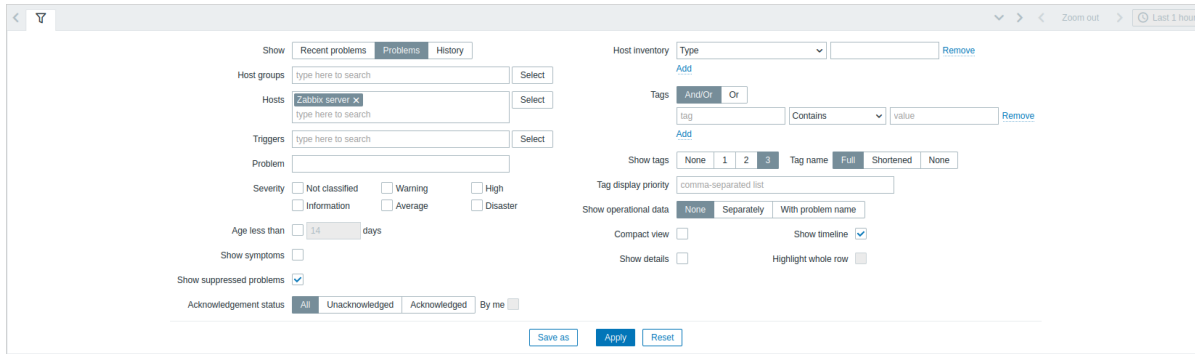

Parameter	Description
<i>Show</i>	Filter by problem status: Recent problems - unresolved and recently resolved problems are displayed (default) Problems - unresolved problems are displayed History - history of all events is displayed
<i>Host groups</i>	Filter by one or more host groups. Specifying a parent host group implicitly selects all nested host groups.
<i>Hosts</i>	Filter by one or more hosts.
<i>Triggers</i>	Filter by one or more triggers.
<i>Problem</i>	Filter by problem name.
<i>Severity</i>	Filter by trigger (problem) severity.
<i>Age less than</i>	Filter by how old the problem is.
<i>Show symptoms</i>	Mark the checkbox to display in its own line problems classified as symptoms.
<i>Show suppressed problems</i>	Mark the checkbox to display problems that would otherwise be suppressed (not shown) because of host maintenance or single problem suppression .
<i>Acknowledgement status</i>	Filter to display all problems, unacknowledged problems only, or acknowledged problems only. Mark the additional checkbox to filter out those problems ever acknowledged by you.
<i>Host inventory</i>	Filter by inventory type and value.
<i>Tags</i>	Filter by event tag name and value. It is possible to include as well as exclude specific tags and tag values. Several conditions can be set. Tag name matching is always case-sensitive. There are several operators available for each condition: Exists - include the specified tag names Equals - include the specified tag names and values (case-sensitive) Contains - include the specified tag names where the tag values contain the entered string (substring match, case-insensitive) Does not exist - exclude the specified tag names Does not equal - exclude the specified tag names and values (case-sensitive) Does not contain - exclude the specified tag names where the tag values contain the entered string (substring match, case-insensitive) There are two calculation types for conditions: And/Or - all conditions must be met, conditions having the same tag name will be grouped by the Or condition Or - enough if one condition is met When filtered, the tags specified here will be displayed first with the problem, unless overridden by the <i>Tag display priority</i> (see below) list.
<i>Show tags</i>	Select the number of displayed tags: None - no <i>Tags</i> column in <i>Monitoring</i> → <i>Problems</i> 1 - <i>Tags</i> column contains one tag 2 - <i>Tags</i> column contains two tags 3 - <i>Tags</i> column contains three tags
<i>Tag name</i>	To see all tags for the problem roll your mouse over the three dots icon. Select tag name display mode: Full - tag names and values are displayed in full Shortened - tag names are shortened to 3 symbols; tag values are displayed in full None - only tag values are displayed; no names
<i>Tag display priority</i>	Enter tag display priority for a problem, as a comma-separated list of tags (for example: <code>customer , scope , component</code>). Tag names only should be used, no values. The tags of this list will always be displayed first, overriding the natural ordering by alphabet.

Parameter	Description
<i>Show operational data</i>	Select the mode for displaying operational data : None - no operational data is displayed Separately - operational data is displayed in a separate column With problem name - append operational data to the problem name, using parentheses for the operational data
<i>Compact view</i>	Mark the checkbox to enable compact view.
<i>Show details</i>	Mark the checkbox to display underlying trigger expressions of the problems. Disabled if <i>Compact view</i> checkbox is marked.
<i>Show timeline</i>	Mark the checkbox to display the visual timeline and grouping. Disabled if <i>Compact view</i> checkbox is marked.
<i>Highlight whole row</i>	Mark the checkbox to highlight the full line for unresolved problems. The problem severity color is used for highlighting. Enabled only if the <i>Compact view</i> checkbox is marked in the standard blue and dark themes. <i>Highlight whole row</i> is not available in the high-contrast themes.

Tabs for favorite filters

Frequently used sets of filter parameters can be saved in tabs.

To save a new set of filter parameters, open the main tab, and configure the filter settings, then press the *Save as* button. In a new popup window, define *Filter properties*.

Filter properties ✕

* Name

Show number of records

Set custom time period

From ⌵

To ⌵

Delete
Save
Cancel

Parameter	Description
<i>Name</i>	The name of the filter to display in the tab list.
<i>Show number of records</i>	Check, if you want the number of problems to be displayed next to the tab name.
<i>Override time period selector</i>	Check to set specific default time period for this filter set. If set, you will only be able to change the time period for this tab by updating filter settings. For tabs without a custom time period, the time range can be changed by pressing the time selector button in the top right corner (button name depends on selected time interval: This week, Last 30 minutes, Yesterday, etc.). This option is available only for filters in <i>Monitoring→Problems</i> .
<i>From/To</i>	Time period start and end in absolute (Y-m-d H:i:s) or relative time syntax (now-1d). Available if <i>Set custom time period</i> is checked.

When saved, the filter is created as a named filter tab and immediately activated.

To edit the filter properties of an existing filter, press the gear symbol next to the active tab name.

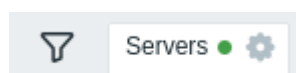

Notes:

- To hide the filter area, click on the name of the current tab. Click on the active tab name again to open the filter area again.





- Keyboard navigation is supported: use arrows to switch between tabs, press *Enter* to open.
- The left/right buttons above the filter may be used to switch between saved filters. Alternatively, the downward pointing button opens a drop-down menu with all saved filters and you can click on the one you need.
- Filter tabs can be re-arranged by dragging and dropping.
- If the settings of a saved filter have been changed (but not saved), a green dot is displayed after the filter name. To update the filter according to the new settings, click on the *Update* button, which is displayed instead of the *Save as* button.
- Current filter settings are remembered in the user profile. When the user opens the page again, the filter settings will have stayed the same.

Note:

To share filters, copy and send to others a URL of an active filter. After opening this URL, other users will be able to save this set of parameters as a permanent filter in their Zabbix account.

See also: [Page parameters](#).



Filter buttons













	Apply specified filtering criteria (without saving).
	Reset current filter and return to saved parameters of the current tab. On the main tab, this will clear the filter.
	Save current filter parameters in a new tab. Only available on the main tab.
	Replace tab parameters with currently specified parameters. Not available on the main tab.

Viewing details

The times for problem start and recovery in *Monitoring* → *Problems* are links. Clicking on them opens more details of the event.

Event details ? 















Trigger details		Actions						
Host	Zabbix server	Step	Time	User/Recipient	Action	Message/Command	Status	Info
Trigger	Interface wlp3s0: Link down	1	2023-01-24 14:15:53	Admin (Zabbix Administrator) martins.valkovskis@zabbix.com		Problem: Interface wlp3s0: Link down	Failed 	
Severity	Average	Item value: down (2)						
Problem expression	1=1 and last(/Zabbix server/vfs.file.contents[/sys/class/net/wlp3s0/operstate])=2 and (last(/Zabbix server/vfs.file.contents[/sys/class/net/wlp3s0/operstate],#1)<>last(/Zabbix server/vfs.file.contents[/sys/class/net/wlp3s0/operstate],#2))	Problem started at 14:15:51 on 2023.01.24						
Recovery expression	last(/Zabbix server/vfs.file.contents[/sys/class/net/wlp3s0/operstate])<=2 or 1=0	Problem name: Interface wlp3s0: Link down						
Event generation	Normal	Host: Zabbix server						
Allow manual close	Yes	Severity: Average						
Enabled	Yes	Operational data: Current state: down (2)						
		Original problem ID: 49414						
		2023-01-24 14:15:51 						

Event details		Event list [previous 20]						
Event	Interface wlp3s0: Link down	Time	Recovery time	Status	Age	Duration	Update	Actions
Operational data	Current state: down (2)	2023-01-24 14:15:51		PROBLEM	1m 37s	1m 37s	Update	
Severity	Average	2023-01-12 13:02:51	2023-01-16 12:13:51	RESOLVED	12d 1h 14m	3d 23h 11m	Update	
Time	2023-01-24 14:15:51	2023-01-10 16:39:51	2023-01-12 11:24:51	RESOLVED	13d 21h 37m	1d 18h 45m	Update	
Acknowledged	No	2023-01-10 13:03:51	2023-01-10 13:04:51	RESOLVED	14d 1h 13m	1m	Update	
Tags	class: os component: network interface: wlp3s0 ...	2023-01-06 18:23:51	2023-01-10 10:51:51	RESOLVED	17d 19h 53m	3d 16h 28m	Update	
Description	This trigger expression works as follows: 1. Can be triggered if operations status is down. 2. 1=1 - user can redefine Context macro to value - 0. That marks this interface as not important. No new trigger will be fired if this interface is down. 3. {TEMPLATE_NAME:METRIC.diff()}=1 - trigger fires only if operational status was up(1) sometime before. (So, do not fire 'eternal off' interfaces.) WARNING: if closed manually - won't fire again on next poll, because of .diff.	2023-01-05 17:13:51	2023-01-06 16:02:51	RESOLVED	18d 21h 3m	22h 49m	Update	
Rank	Cause	2023-01-04 18:43:51	2023-01-05 17:12:51	RESOLVED	19d 19h 33m	22h 29m	Update	
		2023-01-04 12:12:51	2023-01-04 12:15:51	RESOLVED	20d 2h 4m	3m	Update	
		2022-12-15 18:52:51	2022-12-16 10:25:51	RESOLVED	1M 9d 19h	15h 33m	Update	
		2022-12-14 17:35:51	2022-12-15 10:22:51	RESOLVED	1M 10d 20h	16h 47m	Update	
		2022-12-13 16:45:51	2022-12-14 10:05:51	RESOLVED	1M 11d 21h	17h 20m	Update	
		2022-12-12 18:03:51	2022-12-13 11:09:51	RESOLVED	1M 12d 20h	17h 6m	Update	

Note that the problem severity may differ for the trigger and the problem event - if it has been updated for the problem event using the *Update problem* screen.

In the action list, the following icons are used to denote the activity type:

-  - problem event generated

-  - message has been sent
-  - problem event acknowledged
-  - problem event unacknowledged
-  - a comment has been added
-  - problem severity has been increased (e.g. Information → Warning)
-  - problem severity has been decreased (e.g. Warning → Information)
-  - problem severity has been changed, but returned to the original level (e.g. Warning → Information → Warning)
-  - a remote command has been executed
-  - problem event has recovered
-  - the problem has been closed manually
-  - the problem has been suppressed
-  - the problem has been unsuppressed
-  - the problem has been converted to a symptom problem
-  - the problem has been converted to a cause problem

1 Cause and symptom problems

Overview

By default all new problems are classified as cause problems. It is possible to manually reclassify certain problems as symptom problems of the cause problem.

For example, power outage may be the actual root cause why some host is unreachable or some service is down. In this case, "host is unreachable" and "service is down" problems must be classified as symptom problems of "power outage" - the cause problem.

The cause-symptom hierarchy supports only two levels. A problem that is already a symptom cannot be assigned "subordinate" symptom problems; any problems assigned as symptoms to a symptom problem will become symptoms of the same cause problem.

Only cause problems are counted in problem totals in maps, dashboard widgets such as *Problems by severity* or *Problem hosts*, etc. However, problem ranking does not affect services.

A symptom problem can be linked to only one cause problem. Symptom problems are not automatically resolved, if the cause problem is resolved or closed.

Configuration

To reclassify a problem as symptom problem, first select it in the list of **problems**. One or several problems can be selected.



Then go to the cause problem, and in its context menu click on the *Mark selected as symptoms* option.

Problems

<input type="checkbox"/>	Time	Severity	Recovery time	Status	Info	Host	Problem	Duration
<input checked="" type="checkbox"/>	18:15:01	Not classified				Zabbix server	Application unavailable on (23)	1m 4s
<input checked="" type="checkbox"/>	18:15:01	Not classified				Zabbix server	Host (23) unavailable	1m 4s
<input type="checkbox"/>	18:15:01	Not classified				Zabbix server	Power outage on (23)	1m 4s
Today								
<input type="checkbox"/>	2022-10-17 10:38:52	Average		PROBLEM		Zabbix server	Interface e	13d 8h
October								
<input type="checkbox"/>	2022-09-16 12:38:25	Not classified		PROBLEM		Zabbix server	A class: trigge	14d 6h
<input type="checkbox"/>	2022-09-16 12:12:47	Not classified		PROBLEM		Zabbix server	A class: trigge	14d 7h
<input type="checkbox"/>	2022-09-16 12:09:28	Not classified		PROBLEM		Zabbix server	A class: trigge	14d 7h
<input type="checkbox"/>	2022-09-16 12:04:06	Not classified		PROBLEM		Zabbix server	A class: trigge	14d 7h
<input type="checkbox"/>	2022-09-16 11:59:30	Not classified		PROBLEM		Zabbix server	A class: trigge	14d 7h









After that, the selected problems will be updated by the server to symptom problems of the cause problem.

While the status of the problem is being updated, it is displayed in one of two ways:



- A blinking "UPDATING" status is displayed in the Status column;
- A blinking  or  icon in the Info column (this is in effect if *Problems* only are selected in the filter and thus the Status column is not shown).

Display

Symptom problems are displayed below the cause problem and marked accordingly in *Monitoring -> Problems* (and the *Problems* dashboard widget) - with an icon, smaller font and different background.

Current problems									
	Time	Info	Host	Problem • Severity	Duration	Update	Actions	Tags	
2 	13:57:04		Zabbix server	Power outage on (23)	3m 34s	Update	 		
	13:57:04		Zabbix server	Application unavailable on (23)	3m 34s	Update	 		
	13:57:04		Zabbix server	Host (23) unavailable	3m 34s	Update	 		

In collapsed view, only the cause problem is seen; the existence of symptom problems is indicated by the number in the beginning of the line and the icon for expanding the view.

Current problems									
	Time	Info	Host	Problem • Severity	Duration	Update	Actions	Tags	
2 	13:57:04		Zabbix server	Power outage on (23)	3m 34s	Update	 		

It is also possible to additionally display symptom problems in normal font and in their own line. For that select *Show symptoms* in the filter settings or the widget configuration.

Reverting to cause problem

A symptom problem can be reverted back to a cause problem. To do that, either:

- click on the *Mark as cause* option in the context menu of the symptom problem;
- mark the *Convert to cause* option in to the **problem update** screen and click on *Update* (this option will also work if several problems are selected).

2 Hosts

Overview

The *Monitoring* → *Hosts* section displays a full list of monitored hosts with detailed information about host interface, availability, tags, current problems, status (enabled/disabled), and links to easily navigate to the host’s latest data, problem history, graphs, dashboards and web scenarios.

Hosts ? [Create host](#)

Name ▲	Interface	Availability	Tags	Status	Latest data	Problems	Graphs	Dashboards	Web
Apache server DC1	127.0.0.1:10050	ZBX		Enabled	Latest data	Problems	Graphs	Dashboards	Web
Zabbix NYC	127.0.0.1:10050	ZBX	Apache	Enabled	Latest data 2	1	Graphs 27	Dashboards 3	Web
Zabbix server	127.0.0.1:10050	ZBX		Enabled	Latest data 163	1 2 1 1	Graphs 27	Dashboards 3	Web
Zabbix Tokyo	127.0.0.1:10050	ZBX		Enabled	Latest data 26	1	Graphs 5	Dashboards 2	Web

Column	Description
<i>Name</i>	The visible host name. Clicking on the name brings up the host menu . An orange wrench icon  after the name indicates that this host is in maintenance. Click on the column header to sort hosts by name in ascending or descending order.
<i>Interface</i>	The main interface of the host is displayed.

Column	Description
<i>Availability</i>	<p>Host availability per configured interface is displayed.</p> <p>Availability icons represent host interface current status on Zabbix server. Therefore, if you disable a host in the frontend, its availability will update after Zabbix server has synchronized the configuration changes. Similarly, if you enable a host, its availability will update after Zabbix server has synchronized the configuration changes and polled the host.</p> <p>Availability icons represent only those interface types (Agent, SNMP, IPMI, JMX) that are configured.</p> <p>Hovering over the icon displays a pop-up with a list of all interfaces of the same type with details, status, and errors. For Agent interface, the pop-up displays interfaces (passive) and active checks. If a host has active checks only, the Agent interface icon is displayed even if the host does not have an Agent interface (passive) configured.</p> <p>The column is empty for hosts with no interfaces.</p> <p>The current status of all interfaces of one type is indicated by the icon color: Green - all interfaces are available; Yellow - at least one interface is not available, and at least one is available or unknown; Red - all interfaces are not available; Gray - at least one interface is unknown, but none are not available.</p> <p>For details on how Zabbix server determines the "Unknown" status, see Unknown interface status.</p> <p>Active check availability. Active checks also affect host interface availability if at least one active check is enabled on the host. Active check availability is counted towards the total Agent interface availability as described above. For example, if a host has an Agent interface (passive) that is available, but active checks are unknown, the total Agent interface availability is displayed as gray (unknown).</p> <p>Note: There are two exceptions for determining the total Agent interface availability: - if active checks are available, but at least one Agent interface (passive) is unknown while the host also has at least one item using this interface, the total Agent interface availability is displayed as gray (unknown); - if active checks are available and all Agent interfaces (passive) are unknown (and no items are using this interface), the total Agent interface availability is displayed as green (available).</p> <p>To determine active check availability, heartbeat messages are sent in the agent active check thread. The frequency of heartbeat messages is controlled by the <code>HeartbeatFrequency</code> parameter in Zabbix <code>agent</code> or <code>agent 2</code> configuration (default 60 seconds, range 0-3600). Active checks are considered unavailable when the active check heartbeat is older than $2 \times \text{HeartbeatFrequency}$ seconds.</p> <p>Note: Zabbix agents older than version 6.2.x do not send active check heartbeats, so the availability of their hosts remains unknown.</p>
<i>Tags</i>	Tags of the host and all linked templates, with macros unresolved.
<i>Status</i>	Host status - <i>Enabled</i> or <i>Disabled</i> .
<i>Latest data</i>	Click on the column header to sort hosts by status in ascending or descending order. Clicking on the link will open the <i>Monitoring - Latest data</i> page with all the latest data collected from the host.
<i>Problems</i>	The number of items with latest data is displayed in gray. The number of open host problems sorted by severity. The color of the square indicates problem severity. The number on the square means the number of problems for the given severity. Clicking on the icon will open <i>Monitoring - Problems</i> page for the current host. If a host has no problems, a link to the <i>Problems</i> section for this host is displayed as text. Use the filter to select whether suppressed problems should be included (not included by default).
<i>Graphs</i>	Clicking on the link will display graphs configured for the host. The number of graphs is displayed in gray.
<i>Dashboards</i>	If a host has no graphs, the link is disabled (gray text) and no number is displayed. Clicking on the link will display dashboards configured for the host. The number of dashboards is displayed in gray. If a host has no dashboards, the link is disabled (gray text) and no number is displayed.

Column	Description
Web	Clicking on the link will display web scenarios configured for the host. The number of web scenarios is displayed in gray. If a host has no web scenarios, the link is disabled (gray text) and no number is displayed.

Buttons

Create host allows to create a **new host**. This button is available for Admin and Super Admin users only.

View mode buttons being common for all sections are described on the **Monitoring** page.

Using filter

You can use the filter to display only the hosts you are interested in. For better search performance, data is searched with macros unresolved.

The filter is located above the table. It is possible to filter hosts by name, host group, IP or DNS, interface port, tags, problem severity, status (enabled/disabled/any); you can also select whether to display suppressed problems and hosts that are currently in maintenance.

Parameter	Description
<i>Name</i>	Filter by visible host name.
<i>Host groups</i>	Filter by one or more host groups. Specifying a parent host group implicitly selects all nested host groups.
<i>IP</i>	Filter by IP address.
<i>DNS</i>	Filter by DNS name.
<i>Port</i>	Filter by port number.
<i>Severity</i>	Filter by problem severity. By default problems of all severities are displayed. Problems are displayed if not suppressed.
<i>Status</i>	Filter by host status.
<i>Tags</i>	Filter by host tag name and value. Hosts can be filtered by host-level tags as well as tags from all linked templates, including nested templates. It is possible to include as well as exclude specific tags and tag values. Several conditions can be set. Tag name matching is always case-sensitive. There are several operators available for each condition: Exists - include the specified tag names Equals - include the specified tag names and values (case-sensitive) Contains - include the specified tag names where the tag values contain the entered string (substring match, case-insensitive) Does not exist - exclude the specified tag names Does not equal - exclude the specified tag names and values (case-sensitive) Does not contain - exclude the specified tag names where the tag values contain the entered string (substring match, case-insensitive) There are two calculation types for conditions: And/Or - all conditions must be met, conditions having the same tag name will be grouped by the Or condition Or - enough if one condition is met
<i>Show hosts in maintenance</i>	Mark the checkbox to display hosts that are in maintenance (displayed by default).
<i>Show suppressed problems</i>	Mark the checkbox to display problems that would otherwise be suppressed (not shown) because of host maintenance or single problem suppression .

Saving filter

Favorite filter settings can be saved as tabs and then quickly accessed by clicking on the respective tab above the filter.

See more details about [saving filters](#).

1 Graphs

Overview

Host graphs can be accessed from *Monitoring* → *Hosts* by clicking on Graphs for the respective host.

Any [custom graph](#) that has been configured for the host can be displayed, as well as any simple graph.

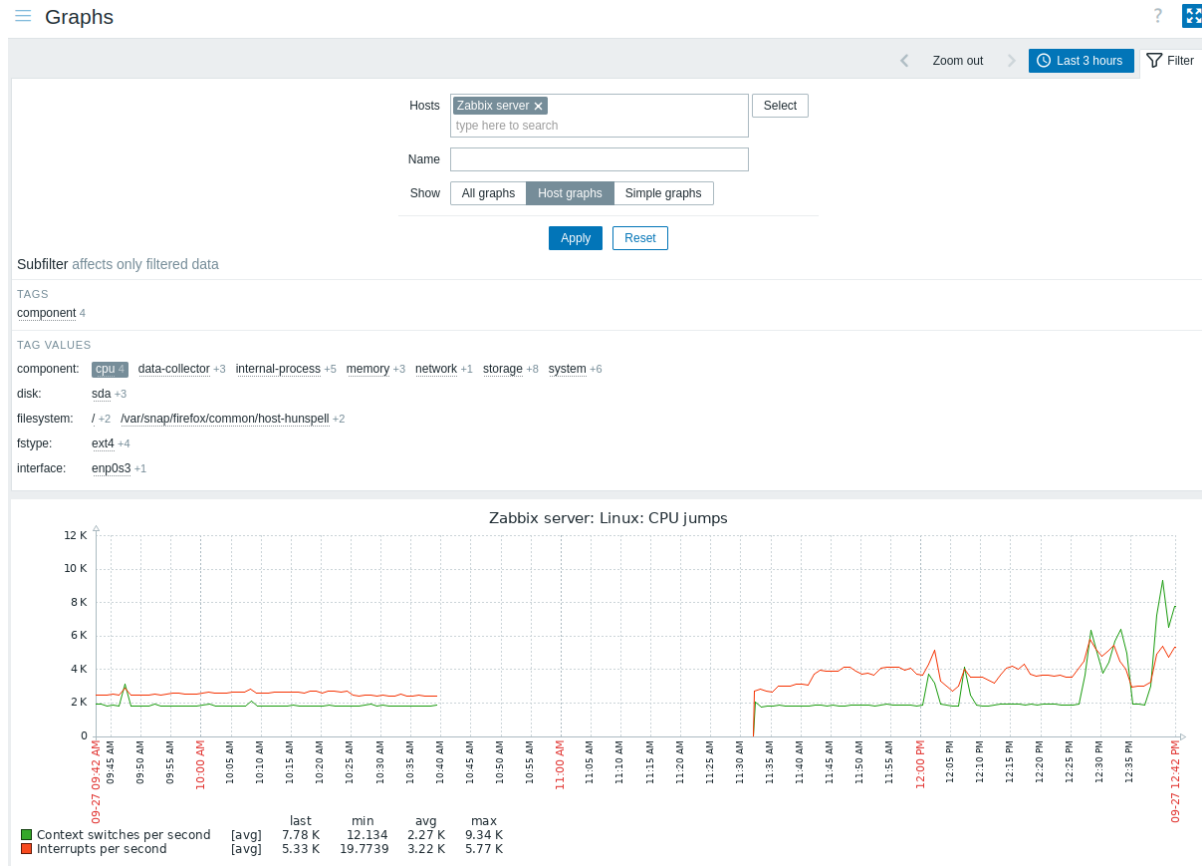

Graphs are sorted by:

- graph name (custom graphs)
- item name (simple graphs)

Graphs for disabled hosts are also accessible.

Time period selector

Take note of the time period selector above the graph. It allows selecting often required periods with one mouse click.

See also: [Time period selector](#)

Using filter

To view a specific graph, select it in the filter. The filter allows to specify the host, the graph name and the *Show* option (all/host graphs/simple graphs).

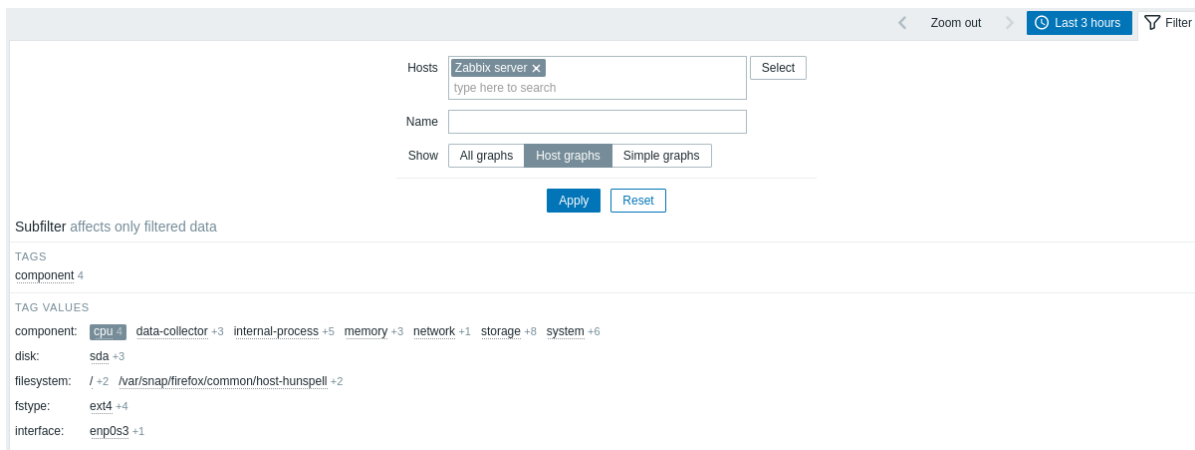

If no host is selected in the filter, no graphs are displayed.

Using subfilter

The subfilter allows to further modify the filtering from the main filter.

It contains clickable links for a quick access to related graphs. Graphs are related by common entity - tag name or value. When a tag name/value is clicked, it is highlighted with a gray background, and graphs are immediately filtered (no need to click *Apply* in the main filter). Clicking another tag name/value adds it to the filtered results. Clicking the tag name/value again removes the filtering.

Subfilters are generated based on the filtered data, which is limited to 1000 records. If you want to see more records in the subfilter, you need to increase the value of *Limit for search and filter results* parameter (in *Administration -> General -> GUI*).

Unlike the main filter, the subfilter is updated together with each table refresh request to always get up-to-date information of available filtering options and their counter numbers.

The number of entities displayed is limited to 100 horizontally. If there are more, a three-dot icon is displayed at the end; it is not clickable. Vertical lists (such as tags with their values) are limited to 20 entries. If there are more, a three-dot icon is displayed; it is not clickable.

A number next to each clickable entity indicates the number of graphs it has in the results of the main filter.

Once one entity is selected, the numbers with other available entities are displayed with a plus sign indicating how many graphs may be added to the current selection.

Buttons

View mode buttons, being common for all sections, are described on the [Monitoring](#) page.

2 Host dashboards

Overview

Host dashboards look similar to [global dashboards](#); however, host dashboards lack an **owner** and display data only for the selected host.

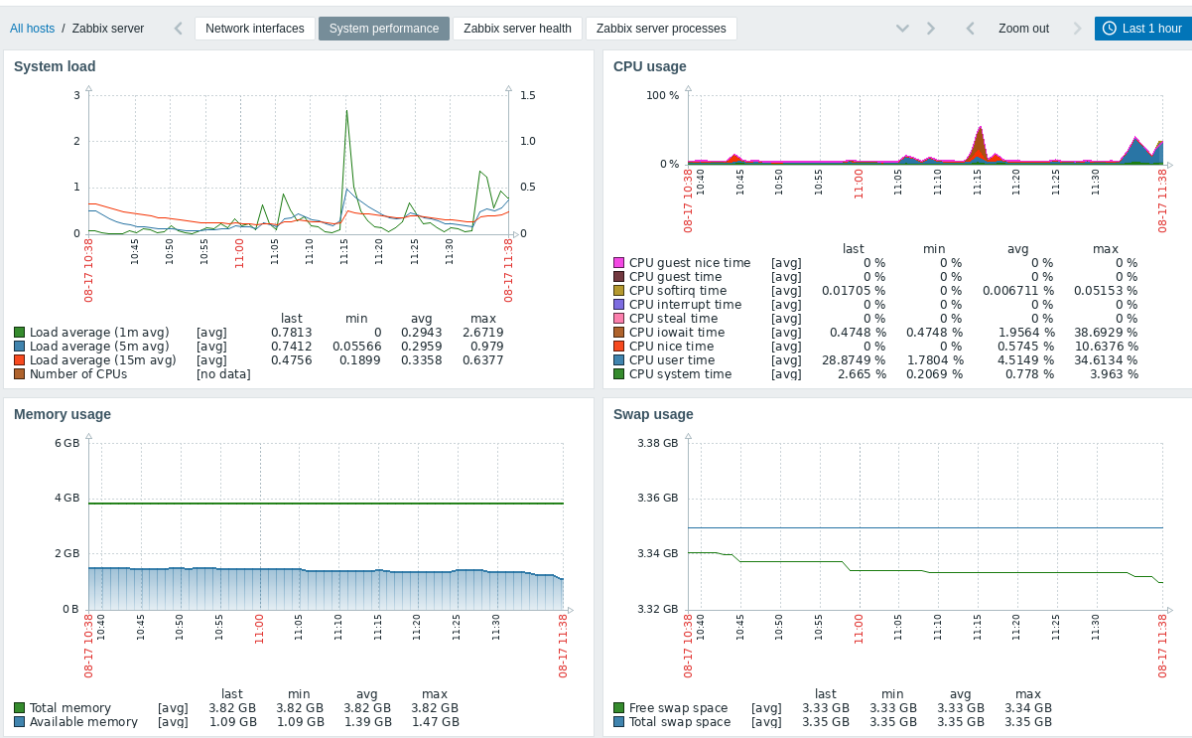

When viewing host dashboards, you can switch between the configured dashboards by clicking:

- the dashboard tabs;
- the arrow buttons under the header;
- the arrow button under the header, which will display the full list of host dashboards available.

To switch to the *Monitoring* → *Hosts* section, click the *All hosts* navigation link under the header in the upper left corner.

Configuration

Host dashboards are configured at the **template** level. Once a template is linked to a host, host dashboards are generated for that host. Note that host dashboards *cannot* be configured in the *Dashboards* section, which is reserved for global dashboards.

Widgets of host dashboards can also be configured only at the **template** level, except for changing the **refresh interval**. Moreover, widgets of host dashboards can only be copied to other host dashboards within the same template. Note that widgets from global dashboards *cannot* be copied to host dashboards.

Note:

Host dashboards used to be host screens before Zabbix 5.2. When importing an older template that contains screens, the screen import will be ignored.

Access

Host dashboards can be accessed:

- after searching for a host name in **global search** (click the *Dashboards* link provided in the search results);
- after clicking a host name in *Inventory* → *Hosts* (click the *Dashboards* link provided in the host overview);
- from the **host menu** by clicking *Dashboards*.

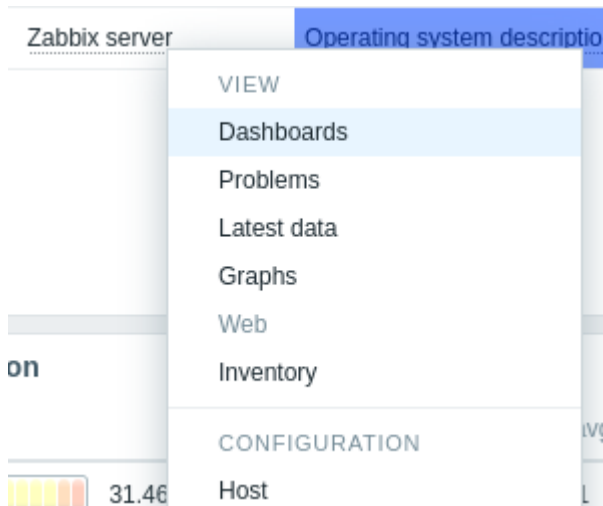

Note that host dashboards *cannot* be directly accessed in the *Dashboards* section, which is reserved for global dashboards.

3 Web scenarios

Overview

Host **web scenario** information can be accessed from *Monitoring* → *Hosts* by clicking on *Web* for the respective host.

Web monitoring ?

Host	Name ▲	Number of steps	Last check	Status	Tags
Zabbix frontend	Frontend check	5	17s	OK	component: web-scen...

Displaying 1 of 1 found

Clicking on the host name brings up the **host menu**. Data of disabled hosts is also accessible. The name of a disabled host is listed in red.

The maximum number of scenarios displayed per page depends on the *Rows per page* user profile **setting**.

By default, only values that fall within the last 24 hours are displayed. This limit has been introduced with the aim of improving initial loading times for large pages of latest data. You can extend this time period by changing the value of *Max history display period* parameter in the *Administration* → *General* → *GUI* menu section.

The scenario name is link to more detailed statistics about it:



Step	Speed	Response time	Response code	Status
First page	31.18 KBps	64.81ms	200	OK
Log in	44.64 KBps	258.36ms	200	OK
Log in Check	74.16 KBps	155.53ms	200	OK
Log out	19.03 KBps	106.17ms	200	OK
Log out check	42.13 KBps	47.96ms	200	OK
TOTAL		632.82ms		OK

< Zoom out > Last 30 minutes

From
 To

- Last 2 days
- Last 7 days
- Last 30 days
- Last 3 months
- Last 6 months
- Last 1 year
- Last 2 years
- Yesterday
- Day before yesterday
- This day last week
- Previous week
- Previous month
- Previous year
- Today
- Today so far
- This week
- This week so far
- This month
- This month so far
- This year
- This year so far
- Last 5 minutes
- Last 15 minutes
- Last 30 minutes
- Last 1 hour
- Last 3 hours
- Last 6 hours
- Last 12 hours
- Last 1 day

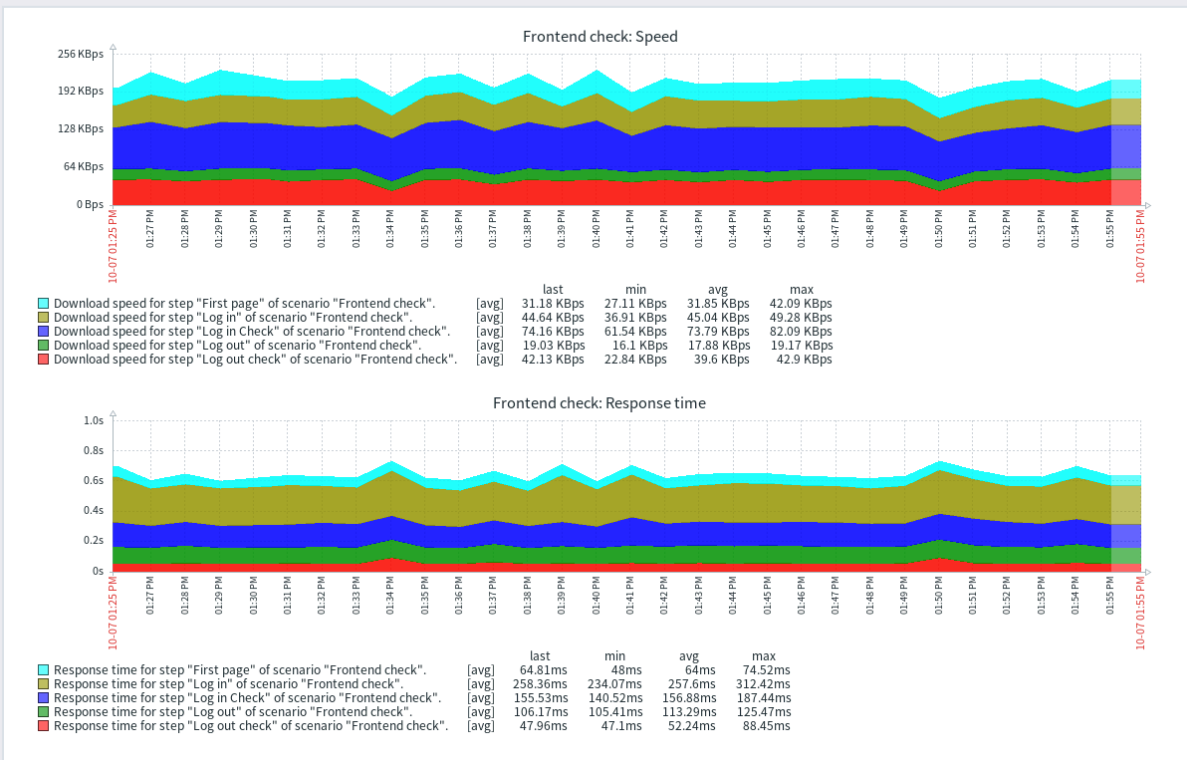

Using filter

The page shows a list of all web scenarios of the selected host. To view web scenarios for another host or host group without returning to the *Monitoring* → *Hosts* page, select that host or group in the filter. You may also filter scenarios based on tags.

Buttons

View mode buttons being common for all sections are described on the *Monitoring* page.

3 Latest data

Overview

The *Monitoring* → *Latest data* section displays the latest values gathered by items.

This section contains the following elements:

- Filter
- Subfilter
- Item list

Note:

The subfilter and item list is displayed only if the filter is set and there are results to display.

Latest data ? [x]

< [Zabbix server] Memory [CPU 17] System [35] Network [9] >

Subfilter affects only filtered data

HOSTS
Zabbix server 7

TAGS
component 7



TAG VALUES
component: application +1 cpu +17 data-collector +13 environment +1 internal-process +20 **memory 7** network +9 os +3 raw +6 security +1 storage +20 system +35
disk: sda +8
filesystem: / +6 /var/snap/firefox/common/host-hunspell +6
interface: enp0s3 +9

DATA
With data Without data

<input type="checkbox"/>	Host	Name ▲	Last check	Last value	Change	Tags	Info
<input type="checkbox"/>	Zabbix server	Available memory [?]	7s	1.84 GB	+2.69 MB	component: memory	Graph
<input type="checkbox"/>	Zabbix server	Available memory in % [?]	6s	48.2995 %	+0.06868 %	component: memory	Graph
<input type="checkbox"/>	Zabbix server	Free swap space [?]	22s	2.82 GB		component: memory component: storage	Graph
<input type="checkbox"/>	Zabbix server	Free swap space in % [?]	14s	84.0597 %		component: memory component: storage	Graph
<input type="checkbox"/>	Zabbix server	Memory utilization [?]	6s	51.7005 %	-0.06868 %	component: memory	Graph
<input type="checkbox"/>	Zabbix server	Total memory [?]	5s	3.82 GB		component: memory	Graph
<input type="checkbox"/>	Zabbix server	Total swap space [?]	12s	3.35 GB		component: memory component: storage	Graph

Displaying 7 of 7 found

0 selected Display stacked graph Display graph Execute now

Column	Description
<i>Host</i>	Name of the host to which the item belongs. Clicking on the name brings up the host context menu . If a host is in maintenance, an orange wrench  icon is displayed after the host's name. If a host is disabled, the name of the host is displayed in red. Note that data of disabled hosts (including graphs and item value lists) is accessible in the <i>Latest data</i> section.
<i>Name</i>	Name of the item. Clicking on the name brings up the item menu . A question mark  icon is displayed next to the item name for all items that have a description. Hover over the icon to display a tooltip with the item description.
<i>Last check</i>	Time since the last item check.
<i>Last value</i>	Most recent value for the item. Values are displayed with unit conversion and value mapping applied. Hover over the value to display raw data. By default, only values received in the last 24 hours are displayed. This limit improves initial loading times for large pages of latest data; to extend it, update the value of the <i>Max history display period</i> parameter in <i>Administration</i> → <i>General</i> → <i>GUI</i> .
<i>Change</i>	Difference between the previous value and the most recent value. For items with an update frequency of 1 day or more, the change amount will never be displayed (with the default setting). In this case, the last value will not be displayed at all if it was received more than 24 hours ago.
<i>Tags</i>	Tags associated with the item. Tags in the item list are clickable. Clicking a tag enables in the subfilter , making the item list display only items containing this tag (and any other tags previously selected in the subfilter). Note that once items have been filtered this way, tags in the item list are no longer clickable. Further modification based on tags (for example, to remove tags or specify other filters) must be done in the subfilter.
<i>Graph/History</i>	Link to simple graph/history of item values.
<i>Info</i>	Additional information about the item. If an item has errors (for example, has become unsupported), an information  icon is displayed. Hover over the icon for details.

Buttons

View mode buttons being common for all sections are described on the [Monitoring](#) page.

Mass actions

Buttons below the list offer mass actions with one or several selected items:

- *Display stacked graph* - display a stacked **ad-hoc graph**.
- *Display graph* - display a simple **ad-hoc graph**.
- *Execute now* - execute a check for new item values immediately. Supported for **passive** checks only (see [more details](#)). This option is available only for hosts with read-write access. Accessing this option for hosts with read-only permissions depends on the **user role** option called *Invoke "Execute now" on read-only hosts*.

To use these options, mark the checkboxes before the respective items, then click on the required button.

Using filter

You can use the filter to display only the items you are interested in. For better search performance, data is searched with macros unresolved.

The filter  icon is located above the item list and the subfilter. Click it to expand the filter.

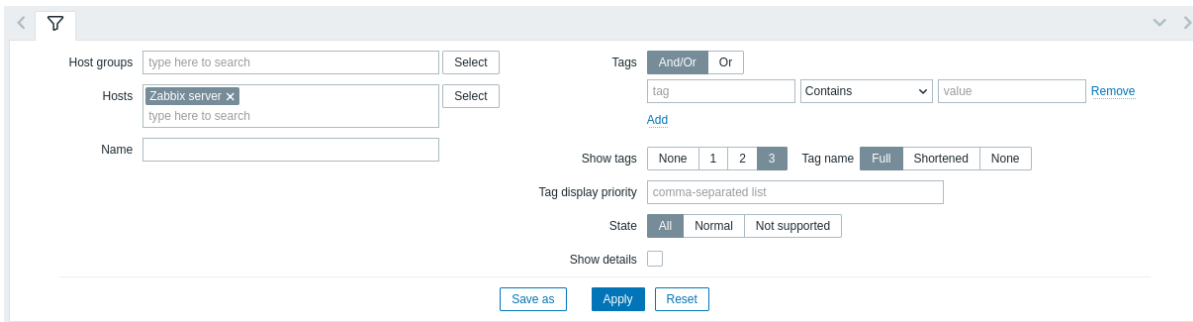

The screenshot shows a filter configuration window. On the left, there are three search fields: 'Host groups' (with a 'Select' button), 'Hosts' (with a dropdown menu showing 'Zabbix server' and a 'Select' button), and 'Name'. On the right, there are 'Tags' options (And/Or, Or), a 'tag' input field, a 'Contains' dropdown, and a 'value' input field with a 'Remove' button. Below these are 'Show tags' options (None, 1, 2, 3), 'Tag name' options (Full, Shortened, None), a 'Tag display priority' input field (with 'comma-separated list' as a hint), 'State' options (All, Normal, Not supported), and a 'Show details' checkbox. At the bottom, there are 'Save as', 'Apply', and 'Reset' buttons.

The filter allows to narrow the item list by host group, host, item name, tag, state and other settings. Specifying a parent host group in the filter implicitly selects all nested host groups. See [Monitoring](#) → [Problems](#) for details on filtering by tags.

The *Show details* filter option allows to extend the information displayed for the items. Mark it to display such details as the item refresh interval, history and trends settings, item type, and item errors (fine/unsupported).

Saving filter

Favorite filter settings can be saved as tabs and then quickly accessed by clicking on the respective tab above the filter.

See more details about [saving filters](#).

Using subfilter

The subfilter allows to further modify the filtering from the main filter.

It contains clickable links for a quick access to related items. Items are related by common entity - host, tag name or value, item state, or data status. When an entity is clicked, the entity is highlighted with a gray background, and items are immediately filtered (no need to click *Apply* in the main filter). Clicking another entity adds it to the filtered results. Clicking the entity again removes the filtering.

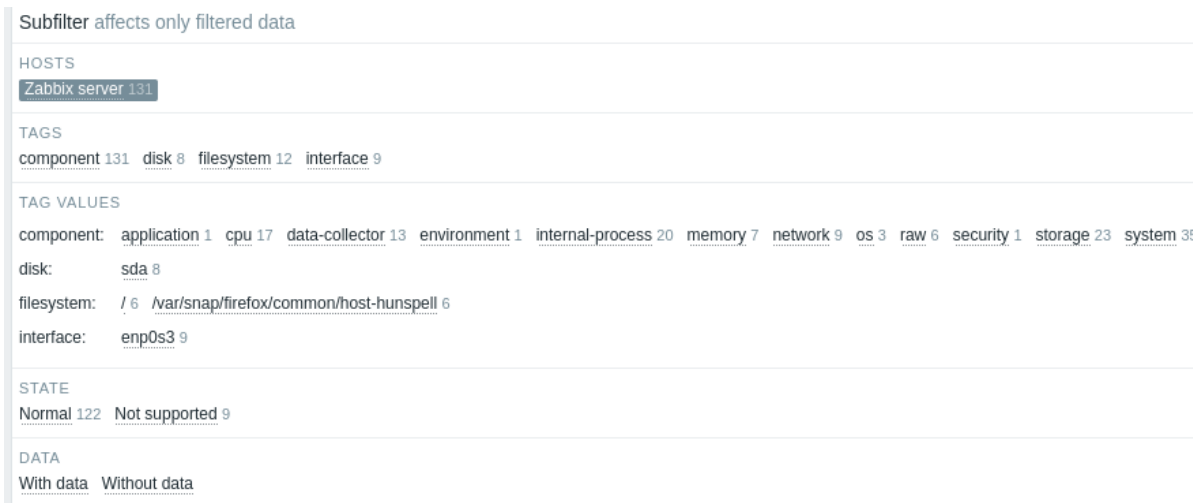

The screenshot shows a subfilter interface with the title 'Subfilter affects only filtered data'. It is divided into several sections: 'HOSTS' with a link to 'Zabbix server 131'; 'TAGS' with links for 'component 131', 'disk 8', 'filesystem 12', and 'interface 9'; 'TAG VALUES' with links for 'component: application 1', 'cpu 17', 'data-collector 13', 'environment 1', 'internal-process 20', 'memory 7', 'network 9', 'os 3', 'raw 6', 'security 1', 'storage 23', and 'system 35'; 'STATE' with links for 'Normal 122' and 'Not supported 9'; and 'DATA' with links for 'With data' and 'Without data'.

Subfilters are generated based on the filtered data, which is limited to 1000 records. If there are 20 hosts each having 100 items (so 2000 records in total), only half of the hosts will be visible in the subfilter. If you want to see more records in the subfilter, you need to increase the value of *Limit for search and filter results* parameter (in *Administration -> General -> GUI*).

Unlike the main filter, the subfilter is updated with each table refresh request to always have up-to-date information of available filtering options and their counter numbers.

For each entity group (hosts, tags, tag values, etc.), up to 10 rows of entities are displayed. If there are more entities, this list can be expanded to display a maximum of 1000 entries (the value of `SUBFILTER_VALUES_PER_GROUP` in *frontend definitions*) by clicking the three-dot `⋮` icon at the end of the list. For *Tag values*, the list can be expanded to display a maximum of 200 tag names with their corresponding values. Note that once fully expanded, the list cannot be collapsed.

A number next to each clickable entity indicates the number of items grouped in it (based on the results of the main filter). When an entity is clicked, the numbers with other available entities are displayed with a plus sign indicating how many items may be added to the current selection. Entities without items are not displayed unless selected in the subfilter before.

Graphs and history

The *Graph/History* column in the item list offers the following links:

- **History** - for all textual items, leading to listings (*Values/500 latest values*) displaying the history of previous item values.
- **Graph** - for all numeric items, leading to a *simple graph*. Note that when the graph is displayed, a dropdown on the upper right offers a possibility to switch to *Values/500 latest values* as well.

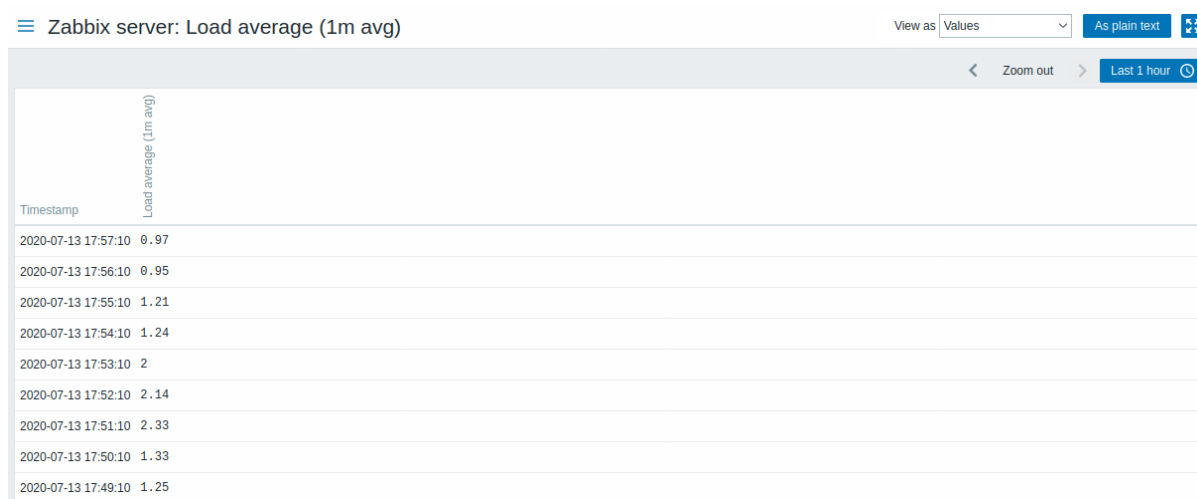

The values displayed in this list are raw, that is, no postprocessing is applied.

Note:

The total amount of values displayed is defined by the value of *Limit for search and filter results* parameter, set in *Administration -> General -> GUI*.

4 Maps

Overview

In the *Monitoring -> Maps* section you can configure, manage and view *network maps*.

When you open this section, you will either see the last map you accessed or a listing of all maps you have access to.

All maps can be either public or private. Public maps are available to all users, while private maps are accessible only to their owner and the users the map is shared with.

Map listing

The screenshot shows the 'Maps' section in Zabbix. At the top right, there are buttons for 'Create map', 'Import', and a 'Filter' dropdown. Below is a table with the following data:

Name	Width	Height	Actions
<input type="checkbox"/> Local network	680	200	Properties Edit
<input type="checkbox"/> Local network2	600	400	Properties Edit

At the bottom, there are controls for '0 selected', 'Export', and 'Delete'. A status message at the bottom right says 'Displaying 2 of 2 found'.

Displayed data:

Column	Description
<i>Name</i>	Name of the map. Click on the name to view the map.
<i>Width</i>	Map width is displayed.
<i>Height</i>	Map height is displayed.
<i>Actions</i>	Two actions are available: Properties - set general map properties Edit - access the grid for adding map elements

To [configure](#) a new map, click on the *Create map* button in the top right-hand corner. To import a map from a YAML, XML, or JSON file, click on the *Import* button in the top right-hand corner. The user who imports the map will be set as its owner.

Two buttons below the list offer some mass-editing options:

- *Export* - export the maps to a YAML, XML, or JSON file
- *Delete* - delete the maps

To use these options, mark the checkboxes before the respective maps, then click on the required button.

Using filter

You can use the filter to display only the maps you are interested in. For better search performance, data is searched with macros unresolved.

Viewing maps

To view a map, click on its name in the list of all maps.

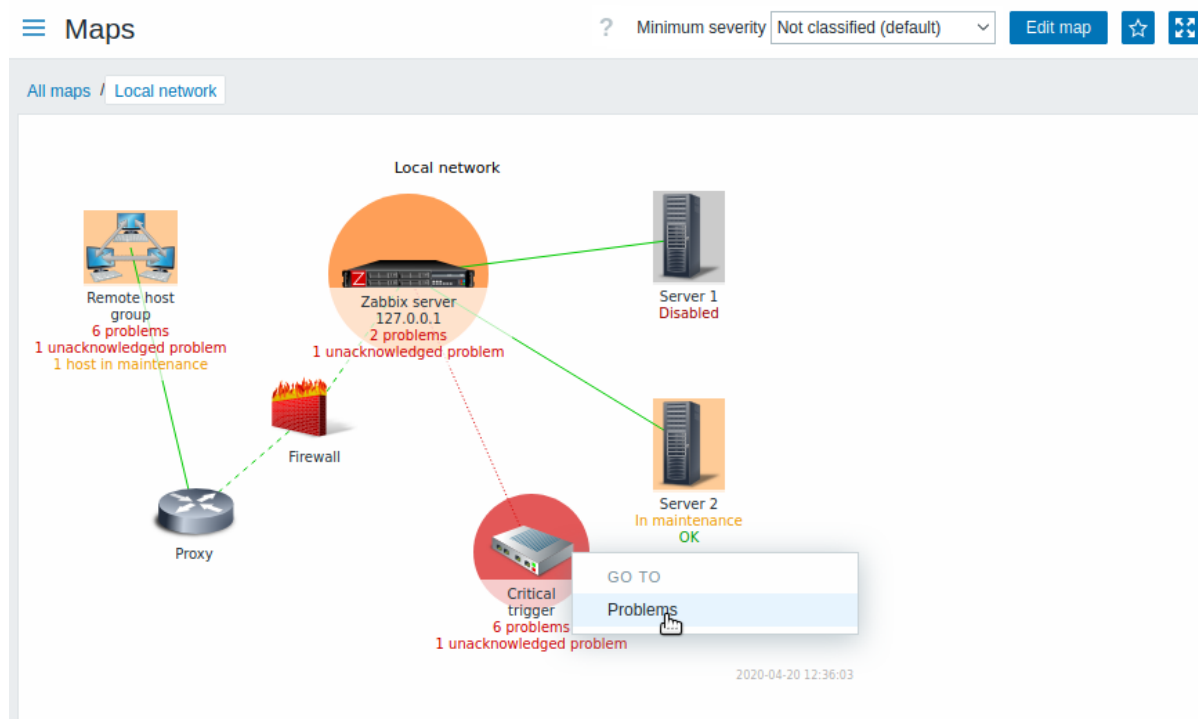

You can use the drop-down in the map title bar to select the lowest severity level of the problem triggers to display. The severity marked as *default* is the level set in the map configuration. If the map contains a sub-map, navigating to the sub-map will retain the higher-level map severity (except if it is *Not classified*, in this case, it will not be passed to the sub-map).

Icon highlighting

If a map element is in problem status, it is highlighted with a round circle. The fill color of the circle corresponds to the severity color of the problem. Only problems on or above the selected severity level will be displayed with the element. If all problems are acknowledged, a thick green border around the circle is displayed.

Additionally:

- a host in **maintenance** is highlighted with an orange, filled square. Note that maintenance highlighting has priority over the problem severity highlighting, if the map element is host.
- a disabled (not-monitored) host is highlighted with a gray, filled square.

Highlighting is displayed if the *Icon highlighting* check-box is marked in map [configuration](#).

Recent change markers



Inward pointing red triangles around an element indicate a recent trigger status change - one that's happened within the last 30 minutes. These triangles are shown if the *Mark elements on trigger status change* check-box is marked in map configuration.

Links

Clicking on a map element opens a menu with some available links. Clicking on the host name brings up the *host menu*.

Buttons

Buttons to the right offer the following options:

	Go to editing of the map content.
	Add map to the favorites widget in <i>Dashboards</i> .
	The map is in the favorites widget in <i>Dashboards</i> . Click to remove map from the favorites widget.

View mode buttons being common for all sections are described on the *Monitoring* page.

Readable summary in maps

A hidden "aria-label" property is available allowing map information to be read with a screen reader. Both general map description and individual element description is available, in the following format:

- for map description: <Map name>, <* of * items in problem state>, <* problems in total>.
- for describing one element with one problem: <Element type>, Status <Element status>, <Element name>, <Problem description>.
- for describing one element with multiple problems: <Element type>, Status <Element status>, <Element name>, <* problems>.
- for describing one element without problems: <Element type>, Status <Element status>, <Element name>.

For example, this description is available:

'Local network, 1 of 6 elements in problem state, 1 problem in total. Host, Status problem, My host, Free disk space is less than 20% on volume / for the following map:

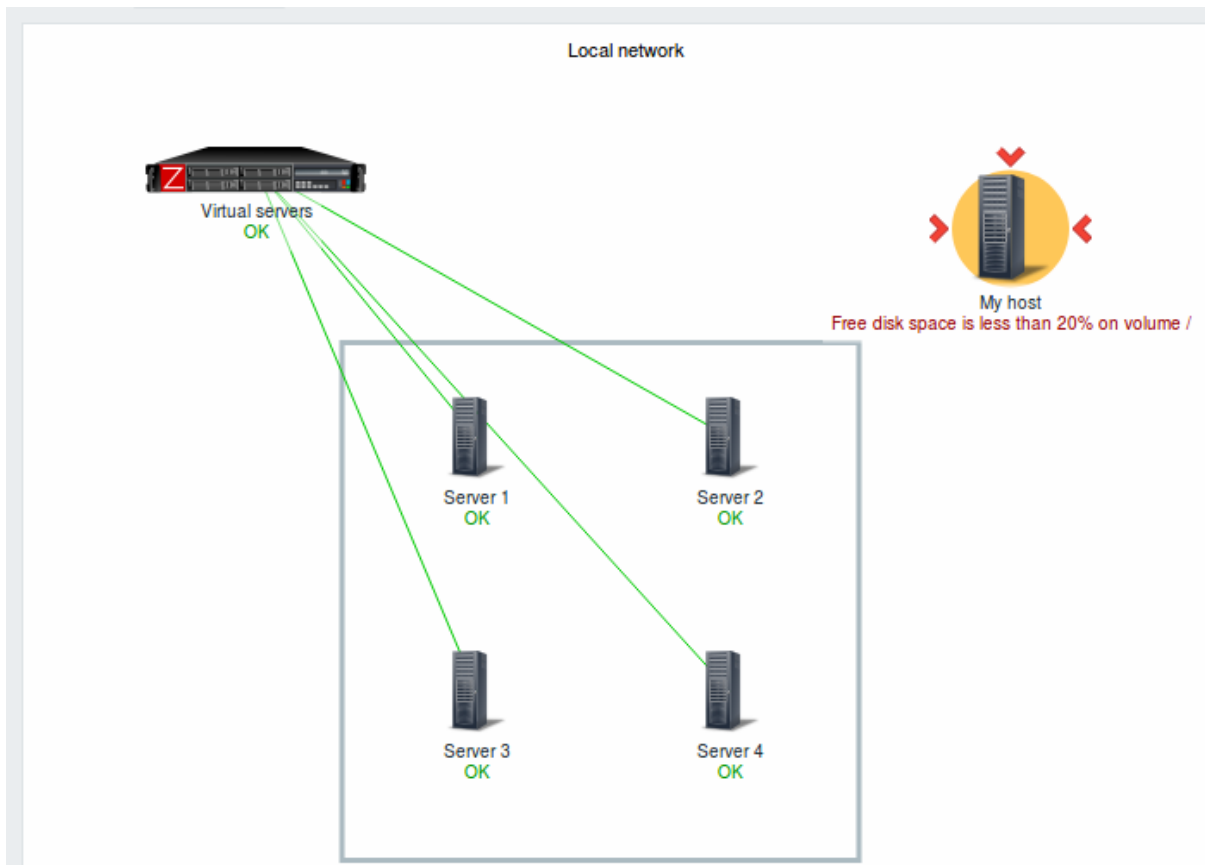

Referencing a network map

Network maps can be referenced by both `sysmapid` and `mapname` GET parameters. For example, `http://zabbix/zabbix/zabbix.php?action=map.view&mapname=Local%20network` will open the map with that name (Local network).

If both `sysmapid` (map ID) and `mapname` (map name) are specified, `mapname` has higher priority.

5 Discovery

Overview

In the *Monitoring* → *Discovery* section results of **network discovery** are shown. Discovered devices are sorted by the discovery rule.

The screenshot shows the 'Status of discovery' page in Zabbix. At the top, there is a search bar for 'Discovery rule' with a 'Select' button and 'Apply'/'Reset' buttons. Below this is a table with columns: 'Discovered device', 'Monitored host', 'Uptime/Downtime', and 'SNMPv2 agent: iso.3.6.1.2.1.1.0'. The table is grouped under 'Local network (14 devices)'. Three rows are visible:

Discovered device	Monitored host	Uptime/Downtime	SNMPv2 agent: iso.3.6.1.2.1.1.0
192.168.3.114 (radix-ilo.zabbix.lan)	Integrated Lights-Out 4 2.61	1d 2h 47m	
192.168.3.72 (winxp.zabbix.lan)	Linux zeus 4.8.6.5-smp 2 SMP Sun Nov 13 14:58:11 CDT	7 days, 20:37:53	7d 20h 37m
192.168.3.70 (win2008r386.zabbix.lan)	Hardware: x86 Family 6 Model 23 Stepping 6 AT AT COMPATIBLE - Software: Windows Version 6.0 Build 6001 Multiprocessor Free	2 days, 02:23:47	2d 2h 23m

Displayed data:

Column	Description
<i>Discovered device</i>	Discovered devices are listed, grouped by the discovery rule. Clicking on the discovery rule brings up the rule menu containing the link to the discovery rule configuration form .
<i>Monitored host</i>	If a device is already monitored, the host name will be listed in this column. Clicking on the host name brings up the host menu .
<i>Uptime/Downtime</i>	The duration of the device being discovered or lost after previous discovery is displayed in this column.
<i>Discovery check</i>	The state of the individual service (discovery check) for each discovered device is displayed. A red cell shows that the service is down. Service uptime or downtime is included within the cell. This column is displayed only if the service has been found on at least one discovered device.

Buttons

View mode buttons being common for all sections are described on the **Monitoring** page.

Using filter

You can use the filter to display only the discovery rules you are interested in. For better search performance, data is searched with macros unresolved.

With nothing selected in the filter, all enabled discovery rules are displayed. To select a specific discovery rule for display, start typing its name in the filter. All matching enabled discovery rules will be listed for selection. More than one discovery rule can be selected.

3 Services

Overview

The Services menu is for the **service monitoring** functions of Zabbix.

1 Services

Overview



In this section you can see a high-level status of whole services that have been configured in Zabbix, based on your infrastructure.

A service may be a hierarchy consisting of several levels of other services, called "child" services, which are attributes to the overall status of the service (see also an overview of the [service monitoring](#) functionality.)

The main categories of service status are *OK* or *Problem*, where the *Problem* status is expressed by the corresponding problem severity name and color.

While the view mode allows to monitor services with their status and other details, you can also [configure](#) the service hierarchy in this section (add/edit services, child services) by switching to the edit mode.

To switch from the view to the edit mode (and back) click on the respective button in the upper right corner:

-  - view services
-  - add/edit services, and child services

Note that access to editing depends on [user role](#) settings.

Viewing services

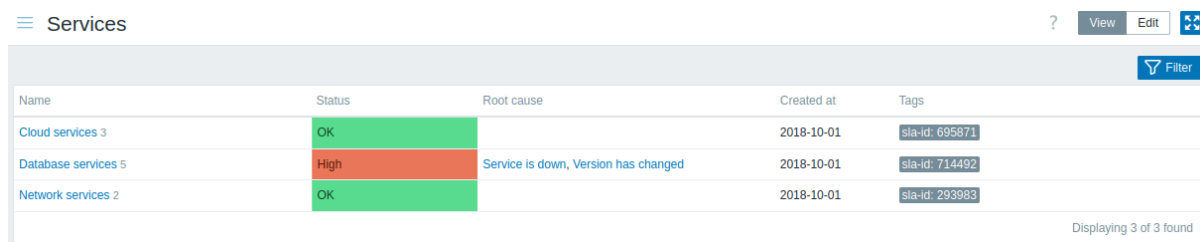

Name	Status	Root cause	Created at	Tags
Cloud services 3	OK		2018-10-01	sla-id: 695871
Database services 5	High	Service is down, Version has changed	2018-10-01	sla-id: 714492
Network services 2	OK		2018-10-01	sla-id: 293983

Displaying 3 of 3 found

A list of the existing services is displayed.

Displayed data:

Parameter	Description
<i>Name</i>	Service name. The service name is a link to service details . The number after the name indicates how many child services the service has.
<i>Status</i>	Service status: OK - no problems (trigger color and severity) - indicates a problem and its severity. If there are multiple problems, the color and severity of the problem with highest severity is displayed.
<i>Root cause</i>	Underlying problems that directly or indirectly affect the service status are listed. The same problems are listed as returned by the {SERVICE.ROOTCAUSE} macro . Click on the problem name to see more details about it in Monitoring → Problems . Problems that do not affect the service status are not in the list.
<i>Created at</i>	The time when the service was created is displayed.
<i>Tags</i>	Tags of the service are displayed. Tags are used to identify a service in service actions and SLAs .

Buttons

View mode buttons being common for all sections are described on the [Monitoring](#) page.



Using filter

You can use the filter to display only the services you are interested in.

Editing services

Click on the *Edit* button to access the edit mode. When in edit mode, the listing is complemented with checkboxes before the entries and also these additional options:

-  - add a child service to this service

-  - edit this service
-  - delete this service

Services ? Create service View Edit

Name	Status	Root cause	Created at	Tags	
Cloud services 3	OK		2028-10-01	sla-id: 695871	+ ↗ ✕
Database services 5	High	Service is down, Version has changed	2024-10-01	sla-id: 714492	+ ↗ ✕
Network services 2	OK		2024-10-01	sla-id: 293983	+ ↗ ✕

0 selected Mass update Delete

To **configure** a new service, click on the *Create service* button in the top right-hand corner.

Service details

To access service details, click on the service name. To return to the list of all services, click on *All services*.

Service details include the info box and the list of child services.

Services ? Create service View Edit

All services / Database services Info Filter

Database services

Parent services:

Status: **High**

SLA: [SLA 714492: 96.9205](#)

Tags: [sla-id: 714492](#)

Name	Status	Root cause	Created at	Tags	
MySQL service 1	High	Service is down	2018-10-01	database: mysql sla-id: 714492	+ ↗ ✕
MySQL service 2	OK		2018-10-01	database: mysql sla-id: 714492	+ ↗ ✕
PostgreSQL service 1	Information	Version has changed	2018-10-01	database: postgresql sla-id: 714492	+ ↗ ✕
PostgreSQL service 2	OK		2018-10-01	database: postgresql sla-id: 714492	+ ↗ ✕
TimescaleDB service 1	OK		2018-10-01	database: timescaledb sla-id: 714492	+ ↗ ✕

0 selected Mass update Delete



To access the info box, click on the *Info* tab. The info box contains the following entries:

- Names of parent services (if any)
- Current status of this service
- Current SLA(s) of this service, in the format `SLA name:service level indicator`. 'SLA name' is also a link to the SLA report for this service. If you position the mouse on the info box next to the service-level indicator (SLI), a pop-up info list is displayed with SLI details. The service-level indicator displays the current service level, in percentage.
- Service tags

The info box also contains a link to the **service configuration**.

To use the filter for child services, click on the *Filter* tab.

When in edit mode, the child service listing is complemented with additional editing options:

-  - add a child service to this service
-  - edit this service
-  - delete this service

2 SLA

Overview

This section allows to view and **configure** SLAs.

SLAs

<input type="checkbox"/> Name ▲	SLO	Effective date	Reporting period	Timezone	Schedule	SLA report	Status
<input type="checkbox"/> SLA:1	99.9%	2022-01-01	Weekly	System default: (UTC+00:00) UTC	Custom ?	SLA report	Enabled
<input type="checkbox"/> SLA:2	100%	2000-01-01	Weekly	System default: (UTC+00:00) UTC	Custom ?	SLA report	Enabled
<input type="checkbox"/> SLA:3	100%	2000-01-01	Weekly	System default: (UTC+00:00) UTC	24x7	SLA report	Enabled
<input type="checkbox"/> SLA:4	99.9%	2000-01-01	Weekly	System default: (UTC+00:00) UTC	24x7	SLA report	Enabled
<input type="checkbox"/> SLA:5	95%	2000-01-01	Weekly	System default: (UTC+00:00) UTC	24x7	SLA report	Enabled

Displaying 5 of 5 found

A list of the configured SLAs is displayed. *Note* that only the SLAs related to services accessible to the user will be displayed (as read-only, unless *Manage SLA* is enabled for the user role).

Displayed data:

Parameter	Description
<i>Name</i>	The SLA name is displayed. The name is a link to SLA configuration .
<i>SLO</i>	The service level objective (SLO) is displayed.
<i>Effective date</i>	The date of starting SLA calculation is displayed.
<i>Reporting period</i>	The period used in the SLA report is displayed - <i>daily, weekly, monthly, quarterly, or annually</i> .
<i>Time zone</i>	The SLA time zone is displayed.
<i>Schedule</i>	The SLA schedule is displayed - 24x7 or custom.
<i>SLA report</i>	Click on the link to see the SLA report for this SLA.
<i>Status</i>	The SLA status is displayed - enabled or disabled.

3 SLA report

Overview

This section allows to view **SLA reports**, based on the criteria selected in the filter.

SLA reports can also be displayed as a **dashboard widget**.

Report

The filter allows to select the report based on the SLA name as well as the service name. It is also possible to limit the displayed period.

Service ▲	SLO	2020-06	2020-07	2020-08	2020-09	2020-10	2020-11	2020-12	2021-01	2021-02	2021-03	2021-04	2021-05	2021-06	2021-07	2021-08	2021-09	2021-10	2021-11	2021-12	2022-01
Availability	100%	100	100	100	100	100	100	100	100	100	100	100	100	100	72.5434	0.0028	28.8072	17.049	0	0	0

Displaying 1 of 1 found

Each column (period) displays the SLI for that period. SLIs that are in breach of the set SLO are highlighted in red.

20 periods are displayed in the report. A maximum of 100 periods can be displayed, if both the *From* date and *To* date are specified.

Report details

If you click on the service name in the report, you can access another report that displays a more detailed view.

SLA:
 From:

Service:
 To:

Month	SLO	SLI	Uptime	Downtime	Error budget	Excluded downtimes
2022-01	100%	0	0	12d 16h 16m	-12d 16h 16m	
2021-12	100%	0	0	1m 1d	-1m 1d	
2021-11	100%	0	0	1m	-1m	
2021-10	100%	17.049	5d 6h 50m	25d 17h 9m	-25d 17h 9m	
2021-09	100%	28.8072	8d 15h 24m	21d 8h 35m	-21d 8h 35m	
2021-08	100%	0.0028	1m 15s	1m 23h	-1m 23h	
2021-07	100%	72.5434	22d 11h 43m	8d 12h 16m	-8d 12h 16m	
2021-06	100%	100	1m	0	0	
2021-05	100%	100	1m 1d	0	0	
2021-04	100%	100	1m	0	0	
2021-03	100%	100	1m 1d	0	0	
2021-02	100%	100	28d	0	0	

Note that **negative problem duration** does not affect SLA calculation or reporting.

4 Inventory

Overview

The Inventory menu features sections providing an overview of host inventory data by a chosen parameter as well as the ability to view host inventory details.

1 Overview

Overview

The *Inventory* → *Overview* section provides ways of having an overview of **host inventory** data.

For an overview to be displayed, choose host groups (or none) and the inventory field by which to display data. The number of hosts corresponding to each entry of the chosen field will be displayed.

Host groups:

Grouping by:

Type	Host count
Server	4
Zabbix server	1

The completeness of an overview depends on how much inventory information is maintained with the hosts.

Numbers in the *Host count* column are links; they lead to these hosts being filtered out in the *Host Inventories* table.

Host groups:

Field: equals

Host	Group	Name	Type	OS	Serial number	Tag	MAC address
Zabbix server	Zabbix servers	martins-hp	Zabbix server	Linux version 5.3.0-46-generic (buildd@lcy01-amd64-013) (gcc version 7.5.0 (Ubuntu 7.5.0-3ubuntu1~18.04)) #38~18.04.1-Ubuntu SMP			

Displaying 1 of 1 found

2 Hosts

Overview

In the *Inventory* → *Hosts* section **inventory data** of hosts are displayed.

You can filter the hosts by host group(s) and by any inventory field to display only the hosts you are interested in.

Host groups

Field

Host	Group	Name	Type	OS	Serial number A	Tag	MAC address A
Zabbix server	Zabbix servers	martins-hp	Zabbix server	Linux version 5.3.0-46-generic (buildd@lcy01-amd64-013) (gcc version 7.5.0 (Ubuntu 7.5.0-3ubuntu1~18.04)) #38~18.04.1-Ubuntu SMP			

Displaying 1 of 1 found

To display all host inventories, select no host group in the filter, clear the comparison field in the filter and press "Filter".

While only some key inventory fields are displayed in the table, you can also view all available inventory information for that host. To do that, click on the host name in the first column.

Inventory details

The **Overview** tab contains some general information about the host along with links to predefined scripts, latest monitoring data and host configuration options:

Host name Zabbix server

Agent interfaces

IP address	DNS name	Connect to	Port
127.0.0.1		<input type="button" value="IP"/> <input type="button" value="DNS"/>	10050

SNMP interfaces

IP address	DNS name	Connect to	Port
127.0.0.1		<input type="button" value="IP"/> <input type="button" value="DNS"/>	161

OS Linux version 5.3.0-46-generic (buildd@lcy01-amd64-013) (gcc version 7.5.0 (Ubuntu 7.5.0-3ubuntu1~18.04)) #38~18.04.1-Ubuntu SMP

Monitoring [Web](#) [Latest data](#) [Problems](#) [Graphs](#) [Dashboards](#)

Configuration [Host](#) [Items 148](#) [Triggers 67](#) [Graphs 28](#) [Discovery 4](#) [Web 1](#)

The **Details** tab contains all available inventory details for the host:

Type Zabbix server

Name martins-hp

OS Linux version 5.3.0-46-generic (buildd@lcy01-amd64-013) (gcc version 7.5.0 (Ubuntu 7.5.0-3ubuntu1~18.04)) #38~18.04.1-Ubuntu SMP

The completeness of inventory data depends on how much inventory information is maintained with the host. If no information is maintained, the *Details* tab is disabled.

5 Reports

Overview

The Reports menu features several sections that contain a variety of predefined and user-customizable reports focused on displaying an overview of such parameters as system information, triggers and gathered data.

1 System information

Overview

In *Reports* → *System information*, a summary of key Zabbix server and system data is displayed. System data is collected using [internal items](#).

Note that in a high availability setup, it is possible to redirect the system information source (server instance). To do this, edit the *zabbix.conf.php* file - uncomment and set `$ZBX_SERVER` or both `$ZBX_SERVER` and `$ZBX_SERVER_PORT` to a server other than the one shown active. Note that when setting `$ZBX_SERVER` only, a default value (10051) for `$ZBX_SERVER_PORT` will be used.

With the high availability setup enabled, a separate block is displayed below the system stats with details of high availability nodes. This block is visible to Zabbix *Super Admin* users only.

System information is also available as a dashboard [widget](#).

System stats

☰ System information ?

Parameter	Value	Details
Zabbix server is running	Yes	192.168.8.103:10051
Zabbix server version	7.0.0	Up to date
Zabbix frontend version	7.0.0	Up to date
Software update last checked	2024-06-15	
Latest release	7.0.0	Release notes
Number of hosts (enabled/disabled)	2	2 / 0
Number of templates	303	
Number of items (enabled/disabled/not supported)	229	201 / 0 / 28
Number of triggers (enabled/disabled [problem/ok])	108	107 / 1 [14 / 93]
Number of users (online)	10	1
Required server performance, new values per second	2.65	
High availability cluster	Enabled	Fail-over delay: 1 minute

Name	Address	Last access	Status
base	192.168.8.103:10051	2s	Active
base2	localhost:10051	5m 11s	Stopped

Displayed data:

Parameter	Value	Details
<i>Zabbix server is running</i>	Status of Zabbix server: Yes - server is running No - server is not running <i>Note:</i> To display the rest of the information the web, frontend needs the server to be running and there must be at least one trapper process started on the server (StartTrappers parameter in zabbix_server.conf file > 0).	Location and port of Zabbix server.

Parameter	Value	Details
<i>Zabbix server version</i>	Current server version number is displayed. <i>Note:</i> It is only displayed when Zabbix server is running.	Server version status is displayed: Up to date - using the latest version; New update available - a more up-to-date version is available; Outdated - the full support period for this version has expired. This information is only available if software update check is enabled in Zabbix server configuration . Nothing is displayed if the last software update check was performed more than a week ago or no data exist about the current version.
<i>Zabbix frontend version</i>	Zabbix frontend version number is displayed.	Zabbix frontend version status is displayed: Up to date - using the latest version; New update available - a more up-to-date version is available; Outdated - the full support period for this version has expired. This information is only available if software update check is enabled in Zabbix server configuration . Nothing is displayed if the last software update check was performed more than a week ago or no data exist about the current version.
<i>Software update last checked</i>	The date of the last Zabbix software update check is displayed. This information is only available if software update check is enabled in Zabbix server configuration .	
<i>Latest release</i>	The number of a newer release (if available) for the current Zabbix version is displayed. This information is only available if software update check is enabled in Zabbix server configuration . Nothing is displayed if the last software update check was performed more than a week ago or no data exist about the current version.	A link to the release notes of the latest available Zabbix release is displayed.
<i>Number of hosts</i>	Total number of hosts configured is displayed.	Number of monitored hosts/not monitored hosts.
<i>Number of templates</i>	Total number of templates is displayed.	
<i>Number of items</i>	Total number of items is displayed.	Number of monitored/disabled/unsupported host-level items. Items on disabled hosts are counted as disabled.
<i>Number of triggers</i>	Total number of triggers is displayed.	Number of enabled/disabled host-level triggers; split of the enabled triggers according to "Problem"/"OK" states. Triggers listed under the "OK" state include triggers with the status "Unknown". Triggers dependent on disabled items or assigned to disabled hosts are counted as disabled.
<i>Number of users</i>	Total number of users configured is displayed.	Number of users online.

Parameter	Value	Details
<i>Required server performance, new values per second</i>	The expected number of new values processed by Zabbix server per second is displayed.	<i>Required server performance</i> is an estimate and can be useful as a guideline. For precise numbers of values processed, use the <code>zabbix[wcache,values,all]</code> internal item . Enabled items from monitored hosts are included in the calculation. Log items are counted as one value per item update interval. Regular interval values are counted; flexible and scheduling interval values are not. The calculation is not adjusted during a "nodata" maintenance period. Trapper items are not counted.
<i>Global scripts on Zabbix server</i>	Disabled will be displayed in this field if global scripts are disabled on Zabbix server by setting <code>EnableGlobalScripts=0</code> in server configuration.	
<i>High availability cluster</i>	Status of high availability cluster for Zabbix server: Disabled - standalone server Enabled - at least one high availability node exists	If enabled, the failover delay is displayed.

System information will also display an error message in the following conditions:

- The database used does not have the required character set or collation (UTF-8).
- The version of the database is below or above the [supported range](#) (available only to users with the *Super admin role* type).
- [Housekeeping](#) for [TimescaleDB](#) is incorrectly configured (history or trend tables contain compressed chunks, but *Override item history period* or *Override item trend period* options are disabled).

High availability nodes

If **high availability cluster** is enabled, then another block of data is displayed with the status of each high availability node.

Name	Address	Last access	Status
node-active	192.168.1.13:10051	12s	Active
node6	192.168.1.10:10053	1h 2m 40s	Unavailable
node7	192.168.1.11:10053	3m 40s	Unavailable
node4	192.168.1.8:10052	1h 34m 29s	Stopped
node5	192.168.1.9:10053	1h 9m 51s	Stopped
node8	192.168.1.12:10051	21m 16s	Stopped
node1	192.168.1.5:10051	17s	Standby
node2	192.168.1.6:10051	16s	Standby
node3	192.168.1.7:10052	16 <input type="text" value="2021-10-20 17:58:47"/>	Standby

Displayed data:

Column	Description
<i>Name</i>	Node name, as defined in server configuration.
<i>Address</i>	Node IP address and port.
<i>Last access</i>	Time of node last access. Hovering over the cell shows the timestamp of last access in long format.
<i>Status</i>	Node status: Active - node is up and working Unavailable - node hasn't been seen for more than failover delay (you may want to find out why) Stopped - node has been stopped or couldn't start (you may want to start it or delete it) Standby - node is up and waiting

2 Scheduled reports

Overview

In *Reports* → *Scheduled reports*, users with sufficient permissions can configure scheduled generation of PDF versions of the dashboards, which will be sent by email to specified recipients.

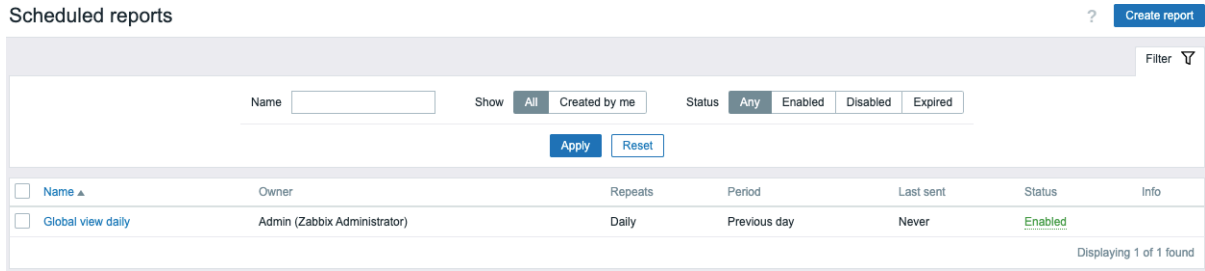

The opening screen displays information about scheduled reports, which can be filtered out for easy navigation - see [Using filter](#) section below.

Displayed data:

Column	Description
<i>Name</i>	Name of the report. Clicking it opens the report configuration form .
<i>Owner</i>	User who created the report.
<i>Repeats</i>	Report generation frequency (daily/weekly/monthly/yearly).
<i>Period</i>	Period for which the report is prepared.
<i>Last sent</i>	The date and time when the latest report has been sent.
<i>Status</i>	Current status of the report (enabled/disabled/expired). Users with sufficient permissions can change the status by clicking it - from "Enabled" to "Disabled" (and back); from "Expired" to "Disabled" (and back). For users with insufficient rights, the status is not clickable.
<i>Info</i>	Displays informative icons: A red icon indicates that report generation has failed; hovering over it will display a tooltip with the error information. A yellow icon indicates that a report was generated, but sending to some (or all) recipients has failed or that a report is expired; hovering over it will display a tooltip with additional information.

Using filter

You may use the filter to narrow down the list of reports. For better search performance, data is searched with macros unresolved.

The following filtering options are available:

- *Name* - partial name match is allowed
- *Report owner* - created by current user or all reports
- *Status* - select between "Any" (show all reports), "Enabled", "Disabled", or "Expired"

The filter is located above the *Scheduled reports* bar. It can be opened and collapsed by clicking the *Filter* tab in the upper right corner.

Mass update

Sometimes you may want to delete or change the status of a number of reports at once. Instead of opening each individual report for editing, you may use the mass update function for that.

To mass-update some reports, do the following:

- Mark the checkboxes of the reports to update in the list
- Click the required button below the list to make the changes (*Enable*, *Disable*, or *Delete*)

3 Availability report

Overview

In *Reports* → *Availability report*, you can see what proportion of time each trigger has been in the problem/OK state.

For each state, a percentage of time is displayed, making it easy to determine the availability of various elements on your system.

Availability report ? Mode: By host

< Zoom out > Last 1 hour Filter

Host groups Select

Hosts Select

Apply Reset

Host	Name	Problems	Ok	Graph
Zabbix server	f. Disk space is critically low		100.00000%	Show
Zabbix server	f. Disk space is low		100.00000%	Show
Zabbix server	f. Filesystem became read-only		100.00000%	Show
Zabbix server	f. Running out of free inodes		100.00000%	Show
Zabbix server	f. Running out of free inodes		100.00000%	Show
Zabbix server	f.etc/passwd has been changed		100.00000%	Show

In the dropdown in the upper-right corner, you can choose the selection mode - whether to display triggers by hosts or by triggers belonging to a template.

Availability report ? Mode: By trigger template

< Zoom out > Last 1 hour Filter

Template group Select

Template Select

Template trigger Select

Host group Select

Apply Reset

Host	Name	Problems	Ok	Graph
Zabbix server	f.etc/passwd has been changed		100.00000%	Show
Zabbix server	Configured max number of open filedescriptors is too low		100.00000%	Show
Zabbix server	Configured max number of processes is too low		100.00000%	Show
Zabbix server	Getting closer to process limit		100.00000%	Show
Zabbix server	has been restarted		100.00000%	Show
Zabbix server	High CPU utilization		100.00000%	Show

The name of the trigger is a link to the latest events of that trigger.

Using filter

The filter can help narrow down the number of hosts and/or triggers displayed. For better search performance, data is searched with macros unresolved.

The filter is located below the *Availability report* bar. It can be opened and collapsed by clicking the *Filter* tab on the right.

Filtering by trigger template

In *By trigger template* mode, results can be filtered by one or several of the parameters listed below.

Parameter	Description
<i>Template group</i>	Filter hosts by triggers that are inherited from templates belonging to the selected template group. Specifying a parent template group implicitly selects all nested template groups.
<i>Template</i>	Filter hosts by triggers that are inherited from the selected template, including nested templates. If a nested template has its own triggers, those triggers will not be displayed.
<i>Template trigger</i>	Filter hosts by the selected trigger. Other triggers of the filtered hosts will not be displayed.
<i>Host group</i>	Filter hosts belonging to the selected host group.

Filtering by host

In *By host* mode, results can be filtered by host or host group. Specifying a parent host group implicitly selects all nested host groups.

Time period selector

The **time period selector** allows to select commonly used time periods with one click. The selector can be expanded and collapsed by clicking the *Time period* tab next to the filter.

Clicking *Show* in the *Graph* column displays availability information in a bar graph where each bar represents a passed week of the current year.

Availability report graph

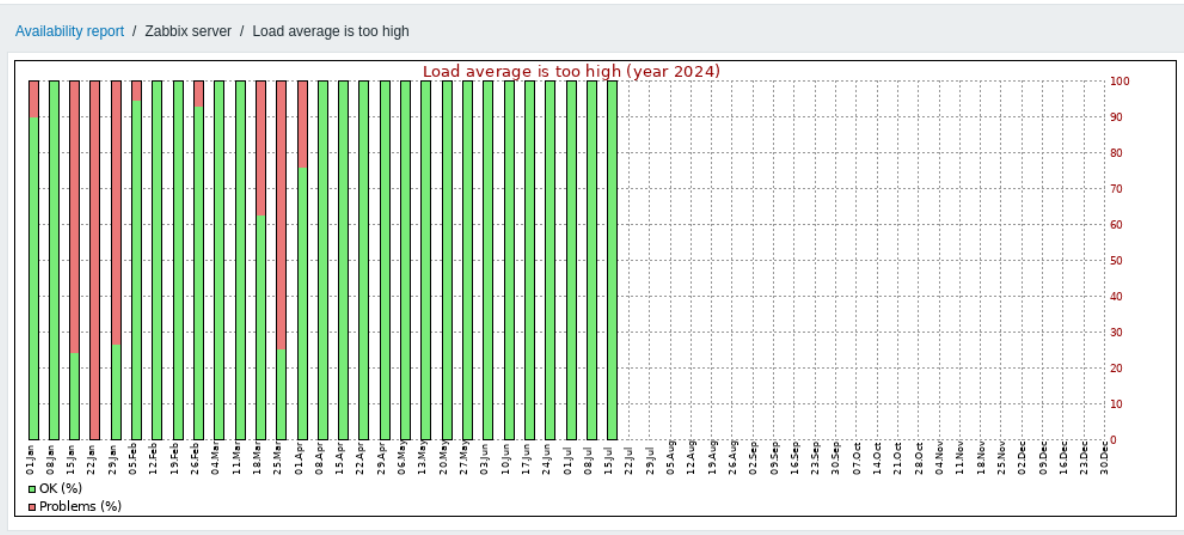

The green of a bar stands for OK time and red - for problem time.

4 Top 100 triggers

Overview

In *Reports* → *Top 100 triggers*, you can see the triggers with the highest number of problems detected during the selected period.

Top 100 triggers

Host groups: Select

Problem tags: Contains Remove

Hosts: Select

Problem:

Severity: Not classified Warning High Information Average Disaster

Apply Reset

Host	Trigger	Severity	Number of problems
Zabbix server	Interface emp0s3: Link down	Average	2
Zabbix server	Load average is too high	Average	2
Zabbix server	Zabbix agent is not available	Average	2
Zabbix server	Zabbix server: More than 100 items having missing data for more than 10 minutes	Warning	2
Zabbix server	Zabbix server: Utilization of escalator processes is high	Average	2

Both host and trigger column entries are links that offer some useful options:

- for host - clicking on the host name brings up the **host menu**
- for trigger - clicking on the trigger name brings up links to the latest events, simple graph for each trigger item, and the configuration forms of the trigger itself and each trigger item

Using filter

You may use the filter to display triggers by host group, host, problem name, tags, or trigger severity. Specifying a parent host group implicitly selects all nested host groups. For better search performance, data is searched with macros unresolved.

The filter is located below the *Top 100 triggers* title. It can be opened and collapsed by clicking on the *Filter* tab on the left.

Time period selector

The **Time period selector** allows to select often required periods with one mouse click. The *Time period* selector can be expanded and collapsed by clicking the *Time period* tab next to the filter.

5 Audit log

Overview

In the *Reports* → *Audit log* section, the records of user and system activity can be viewed.

Note:
 For audit records to be collected and displayed, the *Enable audit logging* checkbox has to be marked in the *Administration* → *Audit log* section. Without this setting enabled, the history of activities will not be recorded in the database and will not be shown in the audit log.

☰ Audit log ?

< Zoom out > Last 3 months Filter

Time	User	IP	Resource	ID	Action	Recordset ID	Details
2022-05-30 12:07:34	Admin	127.0.0.1	User	4	Update	cl3sicbqq0000z8ep87xz41zs	Description: Database manager user.lang: default => en_GB
2022-05-30 12:07:13	Admin	127.0.0.1	User	1	Login	cl3sibvqn0000z8ep40q8w1k	
2022-05-30 12:07:13	guest	127.0.0.1	User	2	Failed login	cl3sibvqn0000z8ep40q8w1k	
2022-05-30 12:07:12	guest	127.0.0.1	User	2	Failed login	cl3sibvem0000z8epvfm1xizi	

Audit log displays the following data:

Column	Description
<i>Time</i>	Timestamp of the audit record.
<i>User</i>	User who performed the activity.
<i>IP</i>	IP from which the activity was initiated.
<i>Resource</i>	Clicking on the hyperlink will result in filtering audit log records by this IP.
<i>ID</i>	Type of the affected resource (<i>All</i> , <i>API token</i> , <i>Action</i> , <i>Authentication</i> , <i>Autoregistration</i> , etc.).
<i>Action</i>	ID of the affected resource.
<i>Recordset ID</i>	Clicking on the hyperlink will result in filtering audit log records by this resource ID.
<i>Details</i>	Type of the activity (<i>Add</i> , <i>Configuration refresh</i> , <i>Delete</i> , <i>Execute</i> , <i>Failed login</i> , <i>History clear</i> , <i>Login</i> , <i>Logout</i> , <i>Push</i> , <i>Update</i>).
	Shared ID for all audit log records created as a result of the same operation.
	For example, when linking a template to a host, a separate audit log record is created for each inherited template entity (item, trigger, etc.) - all these records will have the same <i>Recordset ID</i> .
	Clicking on the hyperlink will result in filtering audit log records by this <i>Recordset ID</i> .
	Description of the resource and detailed information about the performed activity.
	If a record contains more than two rows, an additional <i>Details</i> link will be displayed. Click on this link to view the full list of changes.

Note:
 When a *trapper item* or an *HTTP agent item* (with trapping enabled) has received some data, an entry in the audit log will be added only if the data was sent using the *history.push* API method, and not the *Zabbix sender* utility.

Using filter

The filter is located below the *Audit log* bar. It can be opened and collapsed by clicking the *Filter* tab in the upper right corner.

< Zoom out > Last 7 days Filter

Users: <input type="text" value="Admin (Zabbix Administrator)"/> <input type="button" value="Select"/>	Resource: <input type="text" value="All"/>
Actions: <input type="checkbox"/> Add <input type="checkbox"/> Execute <input checked="" type="checkbox"/> Login <input type="checkbox"/> Update	<input type="checkbox"/> Configuration refresh <input checked="" type="checkbox"/> Failed login <input checked="" type="checkbox"/> Logout
<input type="checkbox"/> Delete	Resource ID: <input type="text"/> Recordset ID: <input type="text"/> IP: <input type="text"/>
<input type="button" value="Apply"/> <input type="button" value="Reset"/>	

You may use the filter to narrow the records by user, affected resource, resource ID, performed operation (*Recordset ID*), and IP. Depending on the resource, one or more specific actions can be selected in the filter.

For better search performance, all data is searched with macros unresolved.

Time period selector

The *Time period selector* allows to select often required periods with one mouse click. The *Time period* selector can be expanded and collapsed by clicking the *Time period* tab in the upper right corner.

6 Action log

Overview

In the *Reports* → *Action log* section users can view details of operations (notifications, remote commands) executed within an action.

Action log

Time	Action	Media type	Recipient	Message	Status	Info
2022-11-24 16:07:46	Report problems to Zabbix administrators	Email	Admin (Zabbix Administrator) Zabbix.Administrator@zabbix.com	Subject: Problem: High CPU utilization (over 90% for 5m) Message: Problem started at 16:07:44 on 2022.11.24 Problem name: High CPU utilization (over 90% for 5m) Host: New host Severity: Warning Operational data: Current utilization: 100% Original problem ID: 1325	In progress	3 retries left
2022-11-24 15:58:36	Report problems to Zabbix administrators	Email	Admin (Zabbix Administrator) Zabbix.Administrator@zabbix.com	Subject: Resolved in 1m 10s: High CPU utilization (over 90% for 5m) Message: Problem has been resolved at 15:58:34 on 2022.11.24 Problem name: High CPU utilization (over 90% for 5m) Problem duration: 1m 10s Host: New host Severity: Warning Original problem ID: 1323	Sent	
2022-11-24 15:57:24	Report problems to Zabbix administrators	Email	Admin (Zabbix Administrator) Zabbix.Administrator@zabbix.com	Subject: Problem: High CPU utilization (over 90% for 5m) Message: Problem started at 15:57:24 on 2022.11.24 Problem name: High CPU utilization (over 90% for 5m) Host: New host Severity: Warning Operational data: Current utilization: 100% Original problem ID: 1323	Failed	

Displayed data:

Column	Description
<i>Time</i>	Timestamp of the operation.
<i>Action</i>	Name of the action causing operations.
<i>Media type</i>	Media type (e.g. Email, Jira, etc.) used for sending a notification.
<i>Recipient</i>	For operations that executed remote commands, this column will be empty. Information about the notification recipient - username, name and surname (in parentheses), and additional information depending on the media type (email, username, etc.).
<i>Message</i>	For operations that executed remote commands, this column will be empty. The content of the message/remote command. A remote command is separated from the target host with a colon symbol: <host>:<command>. For example, if the remote command was executed on Zabbix server, then the information will have the following format: Zabbix server:<command>.
<i>Status</i>	Operation status: <i>In progress</i> - operation for sending a notification is in progress (the remaining number of times the server will try to send the notification is also displayed) <i>Sent</i> - notification has been sent <i>Executed</i> - remote command has been executed <i>Failed</i> - operation has not been completed
<i>Info</i>	Error information (if any) regarding the operation execution.

Buttons

The button at the top right corner of the page offers the following option:

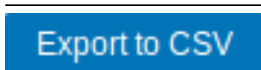

Export action log records from all pages to a CSV file. If a filter is applied, only the filtered records will be exported.

In the exported CSV file the columns "Recipient" and "Message" are divided into several columns - "Recipient's Zabbix username", "Recipient's name", "Recipient's surname", "Recipient", and "Subject", "Message", "Command".

Using filter

The filter is located below the *Action log* bar. It can be opened and collapsed by clicking on the *Filter* tab at the top right corner of the page.

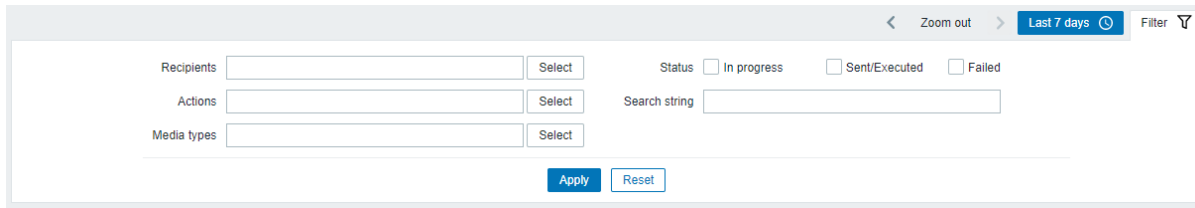

You may use the filter to narrow down the records by notification recipients, actions, media types, status, or by the message/remote command content (*Search string*). For better search performance, data is searched with macros unresolved.

Time period selector

The *Time period selector* allows to select often required periods with one mouse click. The *Time period* selector can be expanded and collapsed by clicking the *Time period* tab next to the filter.

7 Notifications

Overview

In the *Reports* → *Notifications* section a report on the number of notifications sent to each user is displayed.

From the dropdowns in the top right-hand corner you can choose the media type (or all), period (data for each day/week/month/year) and year for the notifications sent.

Month	Admin (Zabbix Administrator)	Database manager	guest	user (New User)
January	6			
February				
March				

Each column displays totals per one system user.

6 Data collection

Overview

This menu features sections that are related to configuring data collection.

1 Items

Overview

The item list for a template can be accessed from *Data collection* → *Templates* by clicking on *Items* for the respective template.

A list of existing items is displayed.

Name	Triggers	Key	Interval	History	Trends	Type	Status	Tags
Available memory	Triggers 1	vm.memory.size[available]	1m	7d	365d	Zabbix agent	Enabled	component: memory
Available memory in %		vm.memory.size[pavailable]	1m	7d	365d	Zabbix agent	Enabled	component: memory
Checksum of /etc/passwd	Triggers 1	vfs.file.cksum[/etc/passwd,sha256]	15m	7d		Zabbix agent	Enabled	component: security
Context switches per second		system.cpu.switches	1m	7d	365d	Zabbix agent	Enabled	component: cpu
CPU guest nice time		system.cpu.util[guest_nice]	1m	7d	365d	Zabbix agent	Enabled	component: cpu
CPU guest time		system.cpu.util[guest]	1m	7d	365d	Zabbix agent	Enabled	component: cpu
CPU idle time		system.cpu.util[idle]	1m	7d	365d	Zabbix agent	Enabled	component: cpu

Displayed data:

Column	Description
<i>Item menu</i>	Click on the three-dot icon to open the item menu .
<i>Template</i>	Template the item belongs to. Clicking on the template name opens the template configuration form .
<i>Name</i>	This column is displayed only if multiple templates or no templates are selected in the filter. Name of the item displayed as a blue link to item details. Clicking on the item name link opens the item configuration form . If the item is inherited from another template, the template name is displayed before the item name, as a gray link. Clicking on the template link will open the item list on that template level.
<i>Triggers</i>	Moving the mouse over Triggers will display an infobox displaying the triggers associated with the item. The number of the triggers is displayed in gray.
<i>Key</i>	Item key is displayed.
<i>Interval</i>	Frequency of the check is displayed.
<i>History</i>	How many days item data history will be kept is displayed.
<i>Trends</i>	How many days item trends history will be kept is displayed.
<i>Type</i>	Item type is displayed (Zabbix agent, SNMP agent, simple check, etc).
<i>Status</i>	Item status is displayed - <i>Enabled</i> or <i>Disabled</i> . By clicking on the status you can change it - from Enabled to Disabled (and back).
<i>Tags</i>	Item tags are displayed. Up to three tags (name:value pairs) can be displayed. If there are more tags, a "..." link is displayed that allows to see all tags on mouseover.

To configure a new item, click on the *Create item* button at the top right corner.

Mass editing options

Buttons below the list offer some mass-editing options:

- *Enable* - change item status to *Enabled*.
- *Disable* - change item status to *Disabled*.
- *Copy* - copy the items to other hosts or templates.
- *Mass update* - **update several properties** for a number of items at once.
- *Delete* - delete the items.

To use these options, mark the checkboxes before the respective items, then click on the required button.

Using filter

The item list may contain a lot of items. By using the filter, you can filter out some of them to quickly locate the items you're looking for. For better search performance, data is searched with macros unresolved.

The *Filter* icon is available at the top right corner. Clicking on it will open a filter where you can specify the desired filtering criteria.

The screenshot shows the Zabbix filter configuration page. At the top, there are navigation links for 'All templates / Linux by Zabbix agent', 'Items 43', 'Triggers 14', 'Graphs 8', 'Dashboards 2', 'Discovery rules 3', and 'Web scenarios'. A 'Filter' icon is in the top right corner. The main area contains several filter criteria with input fields and 'Select' buttons: 'Template groups', 'Templates' (with 'Linux by Zabbix agent X' selected), 'Name', 'Key', 'Value mapping', 'Type' (set to 'All'), 'Type of information' (set to 'All'), 'History', 'Trends', 'Update interval', 'Tags' (with 'tag' and 'value' entered), 'Status' (with 'All', 'Enabled', 'Disabled' buttons), 'Triggers' (with 'All', 'Yes', 'No' buttons), and 'Inherited' (with 'All', 'Yes', 'No' buttons). Below these are 'Apply' and 'Reset' buttons. A note states 'Subfilter affects only filtered data'. The bottom section shows summary statistics for TAGS, TYPES, TYPE OF INFORMATION, WITH TRIGGERS, HISTORY, TRENDS, and INTERVAL.

Parameter	Description
<i>Template groups</i>	Filter by one or more template groups.
<i>Templates</i>	Specifying a parent template group implicitly selects all nested groups.
<i>Name</i>	Filter by item name.

Parameter	Description
<i>Key</i>	Filter by item key.
<i>Value mapping</i>	Filter by the value map used. This parameter is not displayed if the <i>Templates</i> option is empty.
<i>Type</i>	Filter by item type (Zabbix agent, SNMP agent, etc.).
<i>Type of information</i>	Filter by type of information (Numeric unsigned, float, etc.).
<i>History</i>	Filter by how long item history is kept.
<i>Trends</i>	Filter by how long item trends are kept.
<i>Update interval</i>	Filter by item update interval.
<i>Tags</i>	Specify tags to limit the number of items displayed. It is possible to include as well as exclude specific tags and tag values. Several conditions can be set. Tag name matching is always case-sensitive. There are several operators available for each condition: Exists - include the specified tag names Equals - include the specified tag names and values (case-sensitive) Contains - include the specified tag names where the tag values contain the entered string (substring match, case-insensitive) Does not exist - exclude the specified tag names Does not equal - exclude the specified tag names and values (case-sensitive) Does not contain - exclude the specified tag names where the tag values contain the entered string (substring match, case-insensitive) There are two calculation types for conditions: And/Or - all conditions must be met, conditions having the same tag name will be grouped by the Or condition Or - enough if one condition is met
<i>Status</i>	Filter by item status - <i>Enabled</i> or <i>Disabled</i> .
<i>Triggers</i>	Filter items with (or without) triggers.
<i>Inherited</i>	Filter items inherited (or not inherited) from linked templates.

Using subfilter

The subfilter allows to further modify the filtering from the main filter.

It contains clickable links for a quick access to related items. Items are related by common entity - tag, item type, item update interval, etc. When an entity is clicked, the entity is highlighted with a gray background, and items are immediately filtered (no need to click *Apply* in the main filter). Clicking another entity adds it to the filtered results. Clicking the entity again removes the filtering.

Subfilter affects only filtered data

TAGS
[component: application 1](#) [component: cpu 17](#) [component: environment 1](#) [component: memory 7](#) [component: os 3](#) [component: raw 1](#) [component: security 1](#)

TYPES
[Zabbix agent 40](#) [Zabbix internal 1](#) [Dependent item 2](#)

TYPE OF INFORMATION
[Numeric \(float\) 19](#) [Character 7](#) [Numeric \(unsigned\) 16](#) [Text 1](#)

WITH TRIGGERS
[Without triggers 23](#) [With triggers 20](#)

HISTORY
[0 1](#) [1w 42](#)

TRENDS
[0 1](#) [52w 1d 34](#)

INTERVAL
[30s 1](#) [1m 29](#) [15m 3](#) [1h 8](#)

Subfilters are generated based on the filtered data, which is limited to 1000 records. If you want to see more records in the subfilter, you need to increase the value of *Limit for search and filter results* parameter (in *Administration* -> *General* -> *GUI*).

Unlike the main filter, the subfilter is updated with each table refresh request to always have up-to-date information of available filtering options and their counter numbers.

The number of entities displayed is limited to 100 horizontally. If there are more, a three-dot icon is displayed at the end; it is not clickable.

A number next to each clickable entity indicates the number of items grouped in it (based on the results of the main filter). When an entity is clicked, the numbers with other available entities are displayed with a plus sign indicating how many items may be added to the current selection. Entities without items are not displayed unless selected in the subfilter before.

2 Triggers

Overview

The trigger list for a template can be accessed from *Data collection* → *Templates* by clicking on *Triggers* for the respective template.

The screenshot shows the 'Triggers' page with a navigation bar at the top containing 'All templates / Linux OS agent', 'Items 42', 'Triggers 14', 'Graphs 8', 'Dashboards 1', 'Discovery rules 3', and 'Web scenarios'. A 'Filter' button is on the right. The main table has columns: Severity, Name, Operational data, Expression, Status, and Tags. The triggers listed include:

- Information:** Template Module Linux generic by Zabbix agent: /etc/passwd has been changed. Expression: (last(/Linux OS agent/vfs.file.cksum[/etc/passwd],#1)->last(/Linux OS agent/vfs.file.cksum[/etc/passwd],#2))>0.
- Information:** Template Module Linux generic by Zabbix agent: Configured maximum number of open filedescriptors is too low (< {SKERNEL.MAXFILES.MIN}). Expression: last(/Linux OS agent/kernel.maxfiles)<{SKERNEL.MAXFILES.MIN}.
- Information:** Template Module Linux generic by Zabbix agent: Configured maximum number of processes is too low (< {SKERNEL.MAXPROC.MIN}). Expression: last(/Linux OS agent/kernel.maxproc)<{SKERNEL.MAXPROC.MIN}.
- Warning:** Template Module Linux generic by Zabbix agent: Getting closer to process limit (over 80% used). Expression: (ITEM.LASTVALUE1) active, (ITEM.LASTVALUE2) limit. last(/Linux OS agent/proc.num)/last(/Linux OS agent/kernel.maxproc)*100>80.
- Warning:** Template Module Linux CPU by Zabbix agent: High CPU utilization (over {SCPU.UTIL.CRIT}% for 5m). Expression: min(/Linux OS agent/system.cpu.util,5m)>{SCPU.UTIL.CRIT}.

Displayed data:

Column	Description
Severity	Severity of the trigger is displayed by both name and cell background color.
Template	Template the trigger belongs to. Clicking on the template name opens the template configuration form .
Name	This column is displayed only if multiple templates or no templates are selected in the filter. Name of the trigger displayed as a blue link to trigger details. Clicking on the trigger name link opens the trigger configuration form . If the trigger is inherited from another template, the template name is displayed before the trigger name, as a gray link. Clicking on the template link will open the trigger list on that template level.
Operational data	Operational data definition of the trigger, containing arbitrary strings and macros that will resolve dynamically in <i>Monitoring</i> → <i>Problems</i> .
Expression	Trigger expression is displayed. The template-item part of the expression is displayed as a link, leading to the item configuration form.
Status	Trigger status is displayed - <i>Enabled</i> or <i>Disabled</i> . By clicking on the status you can change it - from Enabled to Disabled (and back).
Tags	If a trigger contains tags, tag name and value are displayed in this column.

To configure a new trigger, click on the *Create trigger* button at the top right corner.

Mass editing options

Buttons below the list offer some mass-editing options:

- *Enable* - change trigger status to *Enabled*
- *Disable* - change trigger status to *Disabled*
- *Copy* - copy the triggers to other hosts or templates
- *Mass update* - update several properties for a number of triggers at once
- *Delete* - delete the triggers

To use these options, mark the checkboxes before the respective triggers, then click on the required button.

Using filter

You can use the filter to display only the triggers you are interested in. For better search performance, data is searched with macros unresolved.

The *Filter* icon is available at the top right corner. Clicking on it will open a filter where you can specify the desired filtering criteria.

Parameter	Description
<i>Template groups</i>	Filter by one or more template groups.
<i>Templates</i>	Specifying a parent template group implicitly selects all nested groups. Filter by one or more templates. If template groups are already selected above, template selection is limited to those groups.
<i>Name</i>	Filter by trigger name.
<i>Severity</i>	Select to filter by one or several trigger severities.
<i>Status</i>	Filter by trigger status.
<i>Tags</i>	Filter by trigger tag name and value. It is possible to include as well as exclude specific tags and tag values. Several conditions can be set. Tag name matching is always case-sensitive. There are several operators available for each condition: Exists - include the specified tag names Equals - include the specified tag names and values (case-sensitive) Contains - include the specified tag names where the tag values contain the entered string (substring match, case-insensitive) Does not exist - exclude the specified tag names Does not equal - exclude the specified tag names and values (case-sensitive) Does not contain - exclude the specified tag names where the tag values contain the entered string (substring match, case-insensitive) There are two calculation types for conditions: And/Or - all conditions must be met, conditions having the same tag name will be grouped by the Or condition Or - enough if one condition is met Macros and macro functions are supported in tag name and tag value fields.
<i>Inherited</i>	Filter triggers inherited (or not inherited) from linked templates.
<i>With dependencies</i>	Filter triggers with (or without) dependencies.

3 Graphs

Overview

The custom graph list for a template can be accessed from *Data collection* → *Templates* by clicking on *Graphs* for the respective template.

A list of existing graphs is displayed.

Displayed data:

Column	Description
<i>Template</i>	Template the graph belongs to. Clicking on the template name opens the template configuration form . This column is displayed only if multiple templates or no templates are selected in the filter.
<i>Name</i>	Name of the custom graph, displayed as a blue link to graph details. Clicking on the graph name link opens the graph configuration form . If the graph is inherited from another template, the template name is displayed before the graph name, as a gray link. Clicking on the template link will open the graph list on that template level.
<i>Width</i>	Graph width is displayed.
<i>Height</i>	Graph height is displayed.
<i>Graph type</i>	Graph type is displayed - <i>Normal, Stacked, Pie or Exploded</i> .

To configure a new graph, click on the *Create graph* button at the top right corner.

Mass editing options

Buttons below the list offer some mass-editing options:

- *Copy* - copy the graphs to other hosts or templates
- *Delete* - delete the graphs

To use these options, mark the checkboxes before the respective graphs, then click on the required button.

Using filter

You can filter graphs by template group and template. For better search performance, data is searched with macros unresolved.

4 Discovery rules

Overview

The list of low-level discovery rules for a template can be accessed from *Data collection* → *Templates* by clicking on *Discovery* for the respective template.

A list of existing low-level discovery rules is displayed. It is also possible to see all discovery rules independently of the template, or all discovery rules of a specific template group by changing the filter settings.

☰ Discovery rules
?
Create discovery rule

Template	Name ▲	Items	Triggers	Graphs	Hosts	Key	Interval	Type	Status
<input type="checkbox"/>	Cisco UCS by SNMP Array Controller Cache Discovery	Item prototypes 1	Trigger prototypes 2	Graph prototypes	Host prototypes	array.cache.discovery	1h	SNMP agent	Enabled
<input type="checkbox"/>	Cisco UCS by SNMP Array Controller Discovery	Item prototypes 2	Trigger prototypes 3	Graph prototypes	Host prototypes	array.discovery	1h	SNMP agent	Enabled
<input type="checkbox"/>	Cisco UCS by SNMP FAN Discovery	Item prototypes 1	Trigger prototypes 2	Graph prototypes	Host prototypes	fan.discovery	1h	SNMP agent	Enabled
<input type="checkbox"/>	Cisco UCS by SNMP Physical Disk Discovery	Item prototypes 4	Trigger prototypes 2	Graph prototypes	Host prototypes	physicalDisk.discovery	1h	SNMP agent	Enabled
<input type="checkbox"/>	Cisco UCS by SNMP PSU Discovery	Item prototypes 1	Trigger prototypes 2	Graph prototypes	Host prototypes	psu.discovery	1h	SNMP agent	Enabled
<input type="checkbox"/>	Cisco UCS by SNMP Temperature CPU Discovery	Item prototypes 1	Trigger prototypes 3	Graph prototypes	Host prototypes	temp.cpu.discovery	1h	SNMP agent	Enabled
<input type="checkbox"/>	Cisco UCS by SNMP Temperature Discovery	Item prototypes 4	Trigger prototypes 12	Graph prototypes	Host prototypes	temp.discovery	1h	SNMP agent	Enabled
<input type="checkbox"/>	Cisco UCS by SNMP Unit Discovery	Item prototypes 3	Trigger prototypes 3	Graph prototypes	Host prototypes	unit.discovery	1h	SNMP agent	Enabled
<input type="checkbox"/>	Cisco UCS by SNMP Virtual Disk Discovery	Item prototypes 3	Trigger prototypes 1	Graph prototypes	Host prototypes	virtualdisk.discovery	1h	SNMP agent	Enabled

Displaying 9 of 9 found

0 selected
Enable
Disable
Delete

Displayed data:

Column	Description
<i>Template</i>	The template discovery rule belongs to. Clicking on the template name opens the template configuration form .
<i>Name</i>	Name of the rule, displayed as a blue link. Clicking on the rule name opens the low-level discovery rule configuration form . If the discovery rule is inherited from another template, the template name is displayed before the rule name, as a gray link. Clicking on the template link will open the discovery rule list on that template level.
<i>Items</i>	A link to the list of item prototypes is displayed. The number of existing item prototypes is displayed in gray.

Column	Description
<i>Triggers</i>	A link to the list of trigger prototypes is displayed. The number of existing trigger prototypes is displayed in gray.
<i>Graphs</i>	A link to the list of graph prototypes displayed. The number of existing graph prototypes is displayed in gray.
<i>Hosts</i>	A link to the list of host prototypes displayed. The number of existing host prototypes is displayed in gray.
<i>Key</i>	The item key used for discovery is displayed.
<i>Interval</i>	The frequency of performing discovery is displayed.
<i>Type</i>	The item type used for discovery is displayed (Zabbix agent, SNMP agent, etc).
<i>Status</i>	Discovery rule status is displayed - <i>Enabled</i> or <i>Disabled</i> . By clicking on the status you can change it - from Enabled to Disabled (and back).

To configure a new low-level discovery rule, click on the *Create discovery rule* button at the top right corner.

Mass editing options

Buttons below the list offer some mass-editing options:

- *Enable* - change the low-level discovery rule status to *Enabled*
- *Disable* - change the low-level discovery rule status to *Disabled*
- *Delete* - delete the low-level discovery rules

To use these options, mark the checkboxes before the respective discovery rules, then click on the required button.

Using filter

You can use the filter to display only the discovery rules you are interested in. For better search performance, data is searched with macros unresolved.

The *Filter* icon is available at the top right corner. Clicking on it will open a filter where you can specify the desired filtering criteria such as template, discovery rule name, item key, item type, etc.

Parameter	Description
<i>Template groups</i>	Filter by one or more template groups. Specifying a parent template group implicitly selects all nested groups.
<i>Templates</i>	Filter by one or more templates.
<i>Name</i>	Filter by discovery rule name.
<i>Key</i>	Filter by discovery item key.
<i>Type</i>	Filter by discovery item type.
<i>Update interval</i>	Filter by update interval. Not available for Zabbix trapper and dependent items.
<i>Delete lost resources</i>	Filter by <i>Delete lost resources</i> period.
<i>Disable lost resources</i>	Filter by <i>Disable lost resources</i> period.
<i>Status</i>	Filter by discovery rule status (All/Enabled/Disabled).

1 Item prototypes

Overview

In this section the configured item prototypes of a low-level discovery rule on the template are displayed.

If the template is linked to the host, item prototypes will become the basis of creating real host **items** during low-level discovery.

All templates / Linux by Zabbix agent									
Discovery list / Block devices discovery									
Item prototypes 9									
Trigger prototypes 1									
Graph prototypes 3									
Host prototypes									
<input type="checkbox"/>	Name ▲	Key	Interval	History	Trends	Type	Create enabled	Discover	Tags
<input type="checkbox"/>	... [#DEVNAME]: Get stats: [#DEVNAME]: Disk average queue size (avgqu-sz)	vfs.dev.queue_size[#DEVNAME]	7d	365d	Dependent item	Yes	Yes	component: storage	disk: [#DEVNAME]
<input type="checkbox"/>	... [#DEVNAME]: Get stats: [#DEVNAME]: Disk read rate	vfs.dev.read.rate[#DEVNAME]	7d	365d	Dependent item	Yes	Yes	component: storage	disk: [#DEVNAME]
<input type="checkbox"/>	... [#DEVNAME]: Disk read request avg waiting time (r_await)	vfs.dev.read.await[#DEVNAME]	1m	7d	Calculated	Yes	Yes	component: storage	disk: [#DEVNAME]
<input type="checkbox"/>	... [#DEVNAME]: Get stats: [#DEVNAME]: Disk read time (rate)	vfs.dev.read.time.rate[#DEVNAME]	7d	365d	Dependent item	Yes	Yes	component: storage	disk: [#DEVNAME]
<input type="checkbox"/>	... [#DEVNAME]: Get stats: [#DEVNAME]: Disk utilization	vfs.dev.util[#DEVNAME]	7d	365d	Dependent item	Yes	Yes	component: storage	disk: [#DEVNAME]
<input type="checkbox"/>	... [#DEVNAME]: Get stats: [#DEVNAME]: Disk write rate	vfs.dev.write.rate[#DEVNAME]	7d	365d	Dependent item	Yes	Yes	component: storage	disk: [#DEVNAME]
<input type="checkbox"/>	... [#DEVNAME]: Disk write request avg waiting time (w_await)	vfs.dev.write.await[#DEVNAME]	1m	7d	Calculated	Yes	Yes	component: storage	disk: [#DEVNAME]
<input type="checkbox"/>	... [#DEVNAME]: Get stats: [#DEVNAME]: Disk write time (rate)	vfs.dev.write.time.rate[#DEVNAME]	7d	365d	Dependent item	Yes	Yes	component: storage	disk: [#DEVNAME]
<input type="checkbox"/>	... [#DEVNAME]: Get stats	vfs.file.contents[sys/block/#DEVNAME]stat	1m	0	Zabbix agent	Yes	Yes	component: raw	

0 selected

Displaying 9 of 9 found

Displayed data:

Column	Description
<i>Name</i>	Name of the item prototype, displayed as a blue link. Clicking on the name opens the item prototype configuration form . If the item prototype belongs to a linked template, the template name is displayed before the item name, as a gray link. Clicking on the template link will open the item prototype list on the linked template level.
<i>Key</i>	Key of the item prototype is displayed.
<i>Interval</i>	Frequency of the check is displayed.
<i>History</i>	How many days to keep item data history is displayed.
<i>Trends</i>	How many days to keep item trends history is displayed.
<i>Type</i>	Type of the item prototype is displayed (Zabbix agent, SNMP agent, simple check, etc).
<i>Create enabled</i>	Create the item based on this prototype as: Yes - enabled No - disabled. You can switch between 'Yes' and 'No' by clicking on them.
<i>Discover</i>	Discover the item based on this prototype: Yes - discover No - do not discover. You can switch between 'Yes' and 'No' by clicking on them.
<i>Tags</i>	Tags of the item prototype is displayed.

To configure a new item prototype, click on the *Create item prototype* button at the top right corner.

Mass editing options

Buttons below the list offer some mass-editing options:

- *Create enabled* - create these items as *Enabled*
- *Create disabled* - create these items as *Disabled*
- *Mass update* - mass update these item prototypes
- *Delete* - delete these item prototypes

To use these options, mark the checkboxes before the respective item prototypes, then click on the required button.

2 Trigger prototypes

Overview

In this section the configured trigger prototypes of a low-level discovery rule on the template are displayed.

If the template is linked to the host, trigger prototypes will become the basis of creating real host **triggers** during low-level discovery.

All templates / Template Module Linux filesystems... Discovery list / Mounted filesystem discovery

Item prototypes 4 Trigger prototypes 4 Graph prototypes 1 Host prototypes

Severity	Name	Operational data	Expression	Create enabled	Discover	Tags
Average	{#FSNAME}; Disk space is critically low (used > {SVFS.FS.PUSED.MAX.CRIT:"{#FSNAME}"})%	Space used: {ITEM.LASTVALUE3} of {ITEM.LASTVALUE2} ({ITEM.LASTVALUE1})	last(/Template Module Linux filesystems by Zabbix agent/vfs.fs.size[{#FSNAME},pused])>{SVFS.FS.PUSED.MAX.CRIT:"{#FSNAME}"} and ((last(/Template Module Linux filesystems by Zabbix agent/vfs.fs.size[{#FSNAME},total])-last(/Template Module Linux filesystems by Zabbix agent/vfs.fs.size[{#FSNAME},used]))<5G or timeleft(/Template Module Linux filesystems by Zabbix agent/vfs.fs.size[{#FSNAME},pused],1h,100)<1d)	Yes	Yes	
Warning	{#FSNAME}; Disk space is low (used > {SVFS.FS.PUSED.MAX.WARN:"{#FSNAME}"})% Depends on: Template Module Linux filesystems by Zabbix agent: {#FSNAME}; Disk space is critically low (used > {SVFS.FS.PUSED.MAX.CRIT:"{#FSNAME}"})%	Space used: {ITEM.LASTVALUE3} of {ITEM.LASTVALUE2} ({ITEM.LASTVALUE1})	last(/Template Module Linux filesystems by Zabbix agent/vfs.fs.size[{#FSNAME},pused])>{SVFS.FS.PUSED.MAX.WARN:"{#FSNAME}"} and ((last(/Template Module Linux filesystems by Zabbix agent/vfs.fs.size[{#FSNAME},total])-last(/Template Module Linux filesystems by Zabbix agent/vfs.fs.size[{#FSNAME},used]))<10G or timeleft(/Template Module Linux filesystems by Zabbix agent/vfs.fs.size[{#FSNAME},pused],1h,100)<1d)	Yes	Yes	
Average	{#FSNAME}; Running out of free inodes (free < {SVFS.FS.INODE.PFREE.MIN.CRIT:"{#FSNAME}"})%	Free inodes: {ITEM.LASTVALUE1}	min(/Template Module Linux filesystems by Zabbix agent/vfs.fs.inode[{#FSNAME},pfree],5m)<{SVFS.FS.INODE.PFREE.MIN.CRIT:"{#FSNAME}"}%	Yes	Yes	
Warning	{#FSNAME}; Running out of free inodes (free < {SVFS.FS.INODE.PFREE.MIN.WARN:"{#FSNAME}"})% Depends on: Template Module Linux filesystems by Zabbix agent: {#FSNAME}; Running out of free inodes (free < {SVFS.FS.INODE.PFREE.MIN.CRIT:"{#FSNAME}"})%	Free inodes: {ITEM.LASTVALUE1}	min(/Template Module Linux filesystems by Zabbix agent/vfs.fs.inode[{#FSNAME},pfree],5m)<{SVFS.FS.INODE.PFREE.MIN.WARN:"{#FSNAME}"}%	Yes	Yes	

0 selected Create enabled Create disabled Mass update Delete

Displaying 4 of 4 found

Displayed data:

Column	Description
Severity	Severity of the trigger is displayed by both name and cell background color.
Name	Name of the trigger prototype, displayed as a blue link. Clicking on the name opens the trigger prototype configuration form . If the trigger prototype belongs to a linked template, the template name is displayed before the trigger name, as a gray link. Clicking on the template link will open the trigger prototype list on the linked template level.
Expression	Trigger expression is displayed. The template-item part of the expression is displayed as a link, leading to the item configuration form.
Operational data	Format of the operational data of the trigger is displayed, containing arbitrary strings and macros that will resolve dynamically in <i>Monitoring</i> → <i>Problems</i> .
Create enabled	Create the trigger based on this prototype as: Yes - enabled No - disabled. You can switch between 'Yes' and 'No' by clicking on them.
Discover	Discover the trigger based on this prototype: Yes - discover No - do not discover. You can switch between 'Yes' and 'No' by clicking on them.
Tags	Tags of the trigger prototype are displayed.

To configure a new trigger prototype, click on the *Create trigger prototype* button at the top right corner.

Mass editing options

Buttons below the list offer some mass-editing options:

- *Create enabled* - create these triggers as *Enabled*
- *Create disabled* - create these triggers as *Disabled*
- *Mass update* - mass update these trigger prototypes
- *Delete* - delete these trigger prototypes

To use these options, mark the checkboxes before the respective trigger prototypes, then click on the required button.

3 Graph prototypes

Overview

In this section the configured graph prototypes of a low-level discovery rule on the template are displayed.

If the template is linked to the host, graph prototypes will become the basis of creating real host **graphs** during low-level discovery.

Displayed data:

Column	Description
<i>Name</i>	Name of the graph prototype, displayed as a blue link. Clicking on the name opens the graph prototype configuration form . If the graph prototype belongs to a linked template, the template name is displayed before the graph name, as a gray link. Clicking on the template link will open the graph prototype list on the linked template level.
<i>Width</i>	Width of the graph prototype is displayed.
<i>Height</i>	Height of the graph prototype is displayed.
<i>Type</i>	Type of the graph prototype is displayed - <i>Normal</i> , <i>Stacked</i> , <i>Pie</i> or <i>Exploded</i> .
<i>Discover</i>	Discover the graph based on this prototype: Yes - discover No - do not discover. You can switch between 'Yes' and 'No' by clicking on them.

To configure a new graph prototype, click on the *Create graph prototype* button at the top right corner.

Mass editing options

Buttons below the list offer some mass-editing options:

- *Delete* - delete these graph prototypes

To use these options, mark the checkboxes before the respective graph prototypes, then click on the required button.

4 Host prototypes

Overview

In this section the configured host prototypes of a low-level discovery rule on the template are displayed.

If the template is linked to the host, host prototypes will become the basis of creating real **hosts** during low-level discovery.

Displayed data:

Column	Description
<i>Name</i>	Name of the host prototype, displayed as a blue link. Clicking on the name opens the host prototype configuration form. If the host prototype belongs to a linked template, the template name is displayed before the host name, as a gray link. Clicking on the template link will open the host prototype list on the linked template level.
<i>Templates</i>	Templates of the host prototype are displayed.
<i>Create enabled</i>	Create the host based on this prototype as: Yes - enabled No - disabled. You can switch between 'Yes' and 'No' by clicking on them.

Column	Description
<i>Discover</i>	Discover the host based on this prototype: Yes - discover No - do not discover. You can switch between 'Yes' and 'No' by clicking on them.
<i>Tags</i>	Tags of the host prototype are displayed.

To configure a new host prototype, click on the *Create host prototype* button at the top right corner.

Mass editing options

Buttons below the list offer some mass-editing options:

- *Create enabled* - create these hosts as *Enabled*
- *Create disabled* - create these hosts as *Disabled*
- *Delete* - delete these host prototypes

To use these options, mark the checkboxes before the respective host prototypes, then click on the required button.

5 Web scenarios

Overview

The **web scenario** list for a template can be accessed from *Data collection* → *Templates* by clicking on *Web* for the respective template.

A list of existing web scenarios is displayed.

Name ▲	Number of steps	Interval	Attempts	Authentication	HTTP proxy	Status	Tags
<input type="checkbox"/> Frontend check	5	1m	1	None	No	Enabled	component: web-scen...

Displaying 1 of 1 found

Displayed data:

Column	Description
<i>Name</i>	Name of the web scenario. Clicking on the web scenario name opens the web scenario configuration form . If the web scenario is inherited from another template, the template name is displayed before the web scenario name, as a gray link. Clicking on the template link will open the web scenarios list on that template level.
<i>Number of steps</i>	The number of steps the scenario contains.
<i>Update interval</i>	How often the scenario is performed.
<i>Attempts</i>	How many attempts for executing web scenario steps are performed.
<i>Authentication</i>	Authentication method is displayed - Basic, NTLM or None.
<i>HTTP proxy</i>	Displays HTTP proxy or 'No' if not used.
<i>Status</i>	Web scenario status is displayed - <i>Enabled</i> or <i>Disabled</i> . By clicking on the status you can change it.
<i>Tags</i>	Web scenario tags are displayed. Up to three tags (name:value pairs) can be displayed. If there are more tags, a "..." link is displayed that allows to see all tags on mouseover.

To configure a new web scenario, click on the *Create web scenario* button at the top right corner.

Mass editing options

Buttons below the list offer some mass-editing options:

- *Enable* - change the scenario status to *Enabled*
- *Disable* - change the scenario status to *Disabled*
- *Delete* - delete the web scenarios

To use these options, mark the checkboxes before the respective web scenarios, then click on the required button.

Using filter

You can use the filter to display only the scenarios you are interested in. For better search performance, data is searched with macros unresolved.

The *Filter* link is available above the list of web scenarios. If you click on it, a filter becomes available where you can filter scenarios by template group, template, status and tags.

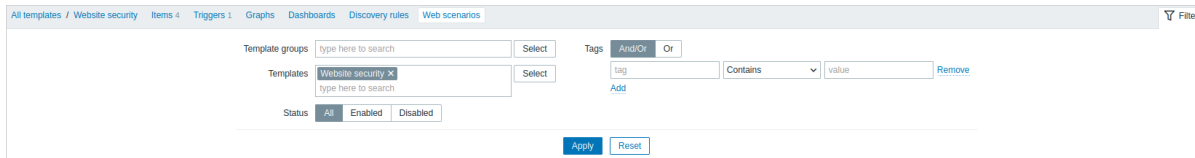

1 Template groups

Overview

In the *Data collection* → *Templates groups* section users can configure and maintain template groups.

A listing of existing template groups with their details is displayed. You can search and filter template groups by name.

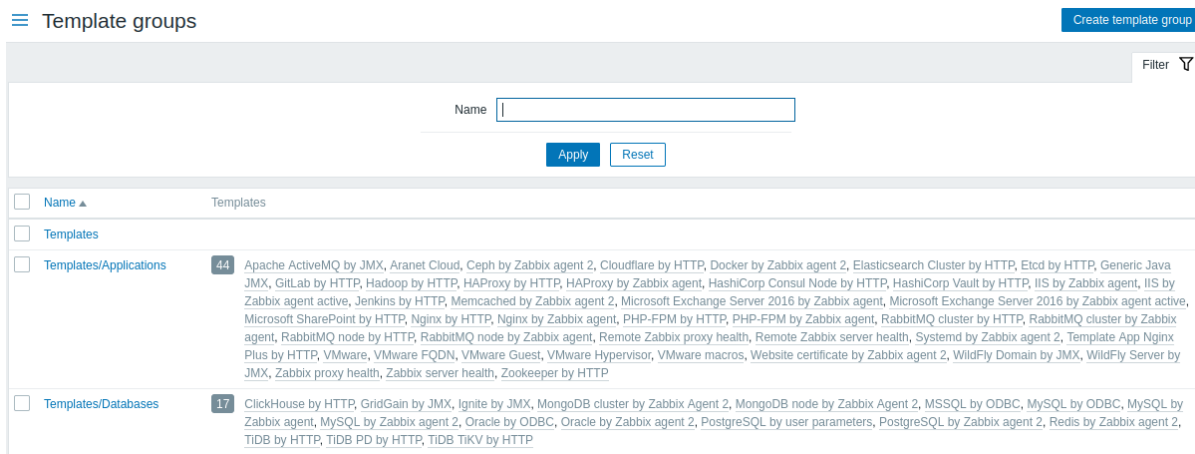

Displayed data:

Column	Description
<i>Name</i>	Name of the template group. Clicking on the group name opens the group configuration form .
<i>Templates</i>	Number of templates in the group (displayed in gray) followed by the list of group members. Clicking on a template name will open the template configuration form. Clicking on the number opens the list of templates in this group.

Mass editing options

To delete several template groups at once, mark the checkboxes before the respective groups, then click on the Delete button below the list.

Using filter

You can use the filter to display only the template groups you are interested in. For better search performance, data is searched with macros unresolved.

2 Host groups

Overview

In the *Data collection* → *Host groups* section users can configure and maintain host groups.

A listing of existing host groups with their details is displayed. You can search and filter host groups by name.

Filter

Apply Reset

<input type="checkbox"/>	Name	Hosts	Info
<input type="checkbox"/>	Applications		
<input type="checkbox"/>	Databases	6 vm-server-a1-db1, vm-server-a1-db2, vm-server-a2-db1, vm-server-a2-db2, vm-server-a3-db1, vm-server-a3-db2	
<input type="checkbox"/>	Discovered hosts	10 vm-esxi-01.example.com, vm-esxi-02.example.com, vm-esxi-03.example.com, vm-server-a1-db1, vm-server-a1-db2, vm-server-a2-db1, vm-server-a2-db2, vm-server-a3-db1, vm-server-a3-db2, vm-vcenter	
<input type="checkbox"/>	Hypervisors	3 vm-esxi-01.example.com, vm-esxi-02.example.com, vm-esxi-03.example.com	
<input type="checkbox"/>	Linux servers	3 HA node 1, HA node 2, Test host	
<input type="checkbox"/>	Virtual machines	1 vm-vcenter	
<input type="checkbox"/>	Discover VMware hypervisors, ..., Discover VMs A3: vmware	10 vm-esxi-01.example.com, vm-esxi-02.example.com, vm-esxi-03.example.com, vm-server-a1-db1, vm-server-a1-db2, vm-server-a2-db1, vm-server-a2-db2, vm-server-a3-db1, vm-server-a3-db2, vm-vcenter	
<input type="checkbox"/>	Zabbix servers	1 Zabbix server	

Displaying 8 of 8 found

0 selected
Enable hosts
Disable hosts
Delete

Displayed data:

Column	Description
<i>Name</i>	Name of the host group. Clicking on the group name opens the group configuration form . Discovered host groups are displayed with low-level discovery rule names as a prefix. Clicking on the LLD rule name opens the host prototype configuration form . Note that discovered host groups are deleted when all LLD rules that discovered it are deleted.
<i>Hosts</i>	Number of hosts in the group (displayed in gray) followed by the list of group members. Clicking on a host name will open the host configuration form. Clicking on the number will, in the whole listing of hosts, filter out those that belong to the group.
<i>Info</i>	Error information (if any) regarding the host group is displayed.

Mass editing options

Buttons below the list offer some mass-editing options:

- *Enable hosts* - change the status of all hosts in the group to "Monitored"
- *Disable hosts* - change the status of all hosts in the group to "Not monitored"
- *Delete* - delete the host groups

To use these options, mark the checkboxes before the respective host groups, then click on the required button.

Using filter

You can use the filter to display only the host groups you are interested in. For better search performance, data is searched with macros unresolved.

3 Templates

Overview

In the *Data collection* → *Templates* section users can configure and maintain templates.

A listing of existing templates with their details is displayed.

Filter

Templates
?
Create template
Import

<input type="checkbox"/>	Name	Hosts	Items	Triggers	Graphs	Dashboards	Discovery	Web	Vendor	Version	Linked templates	Linked to templates	Tags
<input type="checkbox"/>	Linux by Prom	Hosts	Items 34	Triggers 12	Graphs 7	Dashboards 2	Discovery 3	Web	Zabbix	6.4-0			class: os target: linux
<input type="checkbox"/>	Linux by SNMP	Hosts	Items 27	Triggers 10	Graphs 5	Dashboards 2	Discovery 5	Web	Zabbix	6.4-0			class: os target: linux
<input type="checkbox"/>	Linux by Zabbix agent	Hosts 2	Items 43	Triggers 14	Graphs 8	Dashboards 2	Discovery 3	Web	Zabbix	6.4-0			class: os target: linux
<input type="checkbox"/>	Linux by Zabbix agent active	Hosts 1	Items 43	Triggers 15	Graphs 8	Dashboards 2	Discovery 3	Web	Zabbix	6.4-0			class: os target: linux

Displaying 4 of 4 found

0 selected
Export
Mass update
Delete
Delete and clear

Displayed data:

Column	Description
<i>Name</i>	Name of the template. Clicking on the template name opens the template configuration form .
<i>Hosts</i>	Number of editable hosts to which the template is linked; read-only hosts are not included. Clicking on <i>Hosts</i> will open the host list with only those hosts filtered that are linked to the template.
<i>Entities (Items, Triggers, Graphs, Dashboards, Discovery, Web)</i>	Number of the respective entities in the template (displayed in gray). Clicking on the entity name will, in the whole listing of that entity, filter out those that belong to the template.
<i>Linked templates</i>	Templates that are linked to the template.
<i>Linked to templates</i>	Templates that the template is linked to.
<i>Vendor, Version</i>	Template vendor and version; displayed if the template configuration contains such information, and only for out-of-the-box templates, imported templates , or templates modified through the Template API . For out-of-the-box templates, version is displayed as follows: major version of Zabbix, delimiter (" - "), revision number (increased with each new version of the template, and reset with each major version of Zabbix). For example, 7.0-0, 7.0-3, 7.2-0, 7.2-3.
<i>Tags</i>	Tags of the template, with macros unresolved.

To **configure a new template**, click on the *Create template* button in the top right-hand corner.

To **import a template** from a YAML, XML, or JSON file, click on the *Import* button in the top right-hand corner.

Using filter

You can use the filter to display only the templates you are interested in. For better search performance, data is searched with macros unresolved.

The *Filter* link is available below *Create template* and *Import* buttons. If you click on it, a filter becomes available where you can filter templates by template group, linked templates, name and tags.

Parameter	Description
<i>Template groups</i>	Filter by one or more template groups. Specifying a parent template group implicitly selects all nested groups.
<i>Linked templates</i>	Filter by directly linked templates.
<i>Name</i>	Filter by template name.
<i>Vendor</i>	Filter by template vendor.
<i>Version</i>	Filter by template version.

Parameter	Description
<i>Tags</i>	<p>Filter by template tag name and value.</p> <p>Filtering is possible only by template-level tags (not inherited ones). It is possible to include as well as exclude specific tags and tag values. Several conditions can be set. Tag name matching is always case-sensitive.</p> <p>There are several operators available for each condition:</p> <p>Exists - include the specified tag names;</p> <p>Equals - include the specified tag names and values (case-sensitive);</p> <p>Contains - include the specified tag names where the tag values contain the entered string (substring match, case-insensitive);</p> <p>Does not exist - exclude the specified tag names;</p> <p>Does not equal - exclude the specified tag names and values (case-sensitive);</p> <p>Does not contain - exclude the specified tag names where the tag values contain the entered string (substring match, case-insensitive).</p> <p>There are two calculation types for conditions:</p> <p>And/Or - all conditions must be met, conditions having the same tag name will be grouped by the Or condition;</p> <p>Or - enough if one condition is met.</p>

Mass editing options

Buttons below the list offer some mass-editing options:

- *Export* - export the template to a YAML, XML or JSON file;
- *Mass update* - **update several properties** for a number of templates at once;
- *Delete* - delete the template while leaving its linked entities (items, triggers etc.) with the hosts;
- *Delete and clear* - delete the template and its linked entities from the hosts.

To use these options, mark the checkboxes before the respective templates, then click on the required button.

4 Hosts

Overview

In the *Data collection* → *Hosts* section users can configure and maintain hosts.

A listing of existing hosts with their details is displayed.

Displayed data:

Column	Description
<i>Name</i>	<p>Name of the host.</p> <p>Clicking on the host name opens the host configuration form.</p>
<i>Entities (Items, Triggers, Graphs, Discovery, Web)</i>	<p>Clicking on the entity name will display items, triggers, etc., of the host.</p>
<i>Interface</i>	<p>The number of the respective entities is displayed in gray.</p> <p>The main interface of the host is displayed.</p>

Column	Description
<i>Proxy</i>	<p>Assigned proxies are displayed in this column:</p> <p><Proxy name> - host is monitored by standalone proxy (even if the proxy is part of proxy group);</p> <p><Proxy group name: proxy name> - host is monitored by proxy group, and Zabbix server has assigned a proxy to monitor the host;</p> <p><Proxy group name> - host is monitored by proxy group without any proxies, or if Zabbix server has not assigned a proxy to monitor the host;</p> <p>Nothing - host is not monitored by either proxy or proxy group.</p> <p>This column is only displayed if the <i>Monitored by</i> filter option is set to 'Any', 'Proxy', or 'Proxy group'.</p>
<i>Templates</i>	<p>The templates linked to the host are displayed.</p> <p>If other templates are contained in the linked template, those are displayed in parentheses, separated by a comma.</p> <p>Clicking on a template name will open its configuration form.</p>
<i>Status</i>	<p>Host status is displayed - <i>Enabled</i> or <i>Disabled</i>.</p> <p>By clicking on the status you can change it manually.</p> <p>An orange wrench icon  before the host status indicates that this host is in maintenance. Maintenance details are displayed when the mouse pointer is positioned on the icon.</p> <p>Discovered hosts that have been lost are marked with an info icon. The tooltip text provides details on their status.</p>
<i>Availability</i>	<p>Host availability per configured interface is displayed.</p> <p>Availability icons represent host interface current status on Zabbix server. Therefore, if you disable a host in the frontend, its availability will update after Zabbix server has synchronized the configuration changes. Similarly, if you enable a host, its availability will update after Zabbix server has synchronized the configuration changes and polled the host.</p> <p>Availability icons represent only those interface types (Agent, SNMP, IPMI, JMX) that are configured.</p> <p>Hovering over the icon displays a pop-up with a list of all interfaces of the same type with details, status, and errors. For Agent interface, the pop-up displays interfaces (passive) and active checks. If a host has active checks only, the Agent interface icon is displayed even if the host does not have an Agent interface (passive) configured.</p> <p>The column is empty for hosts with no interfaces.</p> <p>The current status of all interfaces of one type is indicated by the icon color:</p> <p>Green - all interfaces are available;</p> <p>Yellow - at least one interface is not available, and at least one is available or unknown;</p> <p>Red - all interfaces are not available;</p> <p>Gray - at least one interface is unknown, but none are not available.</p> <p>For details on how Zabbix server determines the "Unknown" status, see Unknown interface status.</p> <p>Active check availability. Active checks also affect host interface availability if at least one active check is enabled on the host. Active check availability is counted towards the total Agent interface availability as described above. For example, if a host has an Agent interface (passive) that is available, but active checks are unknown, the total Agent interface availability is displayed as gray (unknown).</p> <p>Note: There are two exceptions for determining the total Agent interface availability:</p> <ul style="list-style-type: none"> - if active checks are available, but at least one Agent interface (passive) is unknown while the host also has at least one item using this interface, the total Agent interface availability is displayed as gray (unknown); - if active checks are available and all Agent interfaces (passive) are unknown (and no items are using this interface), the total Agent interface availability is displayed as green (available). <p>To determine active check availability, heartbeat messages are sent in the agent active check thread. The frequency of heartbeat messages is controlled by the <code>HeartbeatFrequency</code> parameter in Zabbix <code>agent</code> or <code>agent 2</code> configuration (default 60 seconds, range 0-3600). Active checks are considered unavailable when the active check heartbeat is older than $2 \times \text{HeartbeatFrequency}$ seconds.</p> <p>Note: Zabbix agents older than version 6.2.x do not send active check heartbeats, so the availability of their hosts remains unknown.</p>

Column	Description
<i>Agent encryption</i>	Encryption status for connections to the host is displayed: None - no encryption; PSK - using pre-shared key; Cert - using certificate.
<i>Info</i>	Error information (if any) regarding the host is displayed.
<i>Tags</i>	Tags of the host with macros unresolved.

To configure a new host, click on the *Create host* button in the top right-hand corner. To import a host from a YAML, XML, or JSON file, click on the *Import* button in the top right-hand corner.

Mass editing options

Buttons below the list offer some mass editing options:

- *Enable* - change host status to *Monitored*;
- *Disable* - change host status to *Not monitored*;
- *Export* - export the hosts to a YAML, XML or JSON file;
- *Mass update* - **update several properties** for a number of hosts at once;
- *Delete* - delete the hosts.

To use these options, mark the checkboxes before the respective hosts, then click on the required button.

Using filter

You can use the filter to display only the hosts you are interested in. For better search performance, data is searched with macros unresolved.

The *Filter* icon is available at the top right corner. Clicking on it will open a filter where you can specify the desired filtering criteria.

Parameter	Description
<i>Host groups</i>	Filter by one or more host groups. Specifying a parent host group implicitly selects all nested host groups.
<i>Templates</i>	Filter by linked templates.
<i>Name</i>	Filter by visible host name.
<i>DNS</i>	Filter by DNS name.
<i>IP</i>	Filter by IP address.
<i>Port</i>	Filter by port number.
<i>Status</i>	Filter by host status.
<i>Monitored by</i>	Filter hosts that are monitored by Zabbix server, proxy, or proxy group.
<i>Proxies</i>	Filter hosts that are monitored by the proxies specified here. This field is only available if "Proxy" is selected in the <i>Monitored by</i> field.
<i>Proxy groups</i>	Filter hosts that are monitored by the proxy groups specified here. This field is only available if "Proxy group" is selected in the <i>Monitored by</i> field.

Parameter	Description
Tags	<p>Filter by host tag name and value.</p> <p>It is possible to include as well as exclude specific tags and tag values. Several conditions can be set. Tag name matching is always case-sensitive.</p> <p>There are several operators available for each condition:</p> <p>Exists - include the specified tag names;</p> <p>Equals - include the specified tag names and values (case-sensitive);</p> <p>Contains - include the specified tag names where the tag values contain the entered string (substring match, case-insensitive);</p> <p>Does not exist - exclude the specified tag names;</p> <p>Does not equal - exclude the specified tag names and values (case-sensitive);</p> <p>Does not contain - exclude the specified tag names where the tag values contain the entered string (substring match, case-insensitive).</p> <p>There are two calculation types for conditions:</p> <p>And/Or - all conditions must be met, conditions having the same tag name will be grouped by the Or condition;</p> <p>Or - enough if one condition is met.</p>

Unknown interface status

Zabbix server displays the "Unknown" status for a host interface (Agent, SNMP, IPMI, JMX) in the following cases:

- Host is disabled.
- Host is set to be monitored by proxy, different proxy, or server if it was previously monitored by proxy.
- Host is monitored by a proxy that appears to be offline (no updates received from the proxy during the maximum heartbeat interval - 1 hour).
- All host items with that interface type are disabled.
- No pollers for that interface type have been configured (for example, the `StartAgentPollers` or `StartSNMPPollers` server configuration parameter is set to 0).

Interface availability is set to "Unknown" after Zabbix server configuration cache synchronization.

Interface availability (Available/Not available) on hosts monitored by proxies is restored after proxy configuration cache synchronization.

For details on host interface unreachability, see [Unreachable/unavailable host interface settings](#).

1 Items

Overview

The item list for a host can be accessed from *Data collection* → *Hosts* by clicking on *Items* for the respective host.

A list of existing items is displayed.

Name	Triggers	Key	Interval	History	Trends	Type	Status	Tags
Linux by Zabbix agent: Available memory	Triggers 1	vm.memory.size[available]	1m	7d	365d	Zabbix agent	Enabled	component: memory
Linux by Zabbix agent: Available memory in %		vm.memory.size[pavailable]	1m	7d	365d	Zabbix agent	Enabled	component: memory
Linux by Zabbix agent: Checksum of /etc/passwd	Triggers 1	vfs.file.cksum[etc/passwd.sha256]	15m	7d		Zabbix agent	Enabled	component: security
Zabbix server health: Configuration cache, % used	Triggers 1	zabbix[cache,buffer,pused]	1m	7d	365d	Zabbix internal	Enabled	component: system
Zabbix server health: Connector queue		zabbix[connector_queue]	1m	7d	365d	Zabbix internal	Enabled	component: system
Linux by Zabbix agent: Context switches per second		system.cpu.switches	1m	7d	365d	Zabbix agent	Enabled	component: cpu
Linux by Zabbix agent: CPU guest nice time		system.cpu.util[guest_nice]	1m	7d	365d	Zabbix agent	Enabled	component: cpu
Linux by Zabbix agent: CPU guest time		system.cpu.util[guest]	1m	7d	365d	Zabbix agent	Enabled	component: cpu

Displayed data:

Column	Description
<i>Item menu</i>	Click on the three-dot icon to open the item menu .

Column	Description
<i>Host</i>	Host of the item. Clicking on the host name opens the host configuration form .
<i>Name</i>	This column is displayed only if multiple hosts or no hosts are selected in the filter. Name of the item displayed as a blue link to item details. Clicking on the item name link opens the item configuration form . If the host item belongs to a template, the template name is displayed before the item name as a gray link. Clicking on the template link will open the item list on the template level. If the item has been created from an item prototype, its name is preceded by the low-level discovery rule name, in orange. Clicking on the discovery rule name will open the item prototype list.
<i>Triggers</i>	Moving the mouse over Triggers will display an infobox displaying the triggers associated with the item. The number of the triggers is displayed in gray.
<i>Key</i>	Item key is displayed.
<i>Interval</i>	Frequency of the check is displayed. <i>Note</i> that passive items can also be checked immediately by pushing the Execute now button .
<i>History</i>	How many days item data history will be kept is displayed.
<i>Trends</i>	How many days item trends history will be kept is displayed.
<i>Type</i>	Item type is displayed (Zabbix agent, SNMP agent, simple check, etc).
<i>Status</i>	Item status is displayed - <i>Enabled</i> , <i>Disabled</i> or <i>Not supported</i> . You can change the status manually by clicking on it - from Enabled to Disabled (and back); from Not supported to Disabled (and back). Discovered items that have been lost are marked with an info icon. The tooltip text provides details on their status.
<i>Tags</i>	Item tags are displayed. Up to three tags (name:value pairs) can be displayed. If there are more tags, a "..." link is displayed that allows to see all tags on mouseover.
<i>Info</i>	If the item is working correctly, no icon is displayed in this column. In case of errors, a square icon with the letter "i" is displayed. Hover over the icon to see a tooltip with the error description.

To configure a new item, click on the *Create item* button at the top right corner.

Mass editing options

Buttons below the list offer some mass-editing options:

- *Enable* - change item status to *Enabled*
- *Disable* - change item status to *Disabled*
- *Execute now* - execute a check for new item values immediately. Supported for **passive** checks only (see [more details](#)).
Note that when checking for values immediately, configuration cache is not updated, thus the values will not reflect very recent changes to item configuration.
- *Clear history and trends* - delete history and trend data for items.
- *Copy* - copy the items to other hosts or templates.
- *Mass update* - [update several properties](#) for a number of items at once.
- *Delete* - delete the items.

To use these options, mark the checkboxes before the respective items, then click on the required button.

Using filter

You can use the filter to display only the items you are interested in. For better search performance, data is searched with macros unresolved.

The *Filter* icon is available at the top right corner. Clicking on it will open a filter where you can specify the desired filtering criteria.

Parameter	Description
<i>Host groups</i>	Filter by one or more host groups. Specifying a parent host group implicitly selects all nested host groups. Host groups containing templates only cannot be selected.
<i>Hosts</i>	Filter by one or more hosts.
<i>Name</i>	Filter by item name.
<i>Key</i>	Filter by item key.
<i>Value mapping</i>	Filter by the value map used.
<i>Type</i>	This parameter is not displayed if the <i>Hosts</i> option is empty. Filter by item type (Zabbix agent, SNMP agent, etc.).
<i>Type of information</i>	Filter by type of information (Numeric unsigned, float, etc.).
<i>History</i>	Filter by how long item history is kept.
<i>Trends</i>	Filter by how long item trends are kept.
<i>Update interval</i>	Filter by item update interval.
<i>Tags</i>	Specify tags to limit the number of items displayed. It is possible to include as well as exclude specific tags and tag values. Several conditions can be set. Tag name matching is always case-sensitive. There are several operators available for each condition: Exists - include the specified tag names Equals - include the specified tag names and values (case-sensitive) Contains - include the specified tag names where the tag values contain the entered string (substring match, case-insensitive) Does not exist - exclude the specified tag names Does not equal - exclude the specified tag names and values (case-sensitive) Does not contain - exclude the specified tag names where the tag values contain the entered string (substring match, case-insensitive) There are two calculation types for conditions: And/Or - all conditions must be met, conditions having the same tag name will be grouped by the Or condition Or - enough if one condition is met
<i>State</i>	Filter by item state - <i>Normal</i> or <i>Not supported</i> .
<i>Status</i>	Filter by item status - <i>Enabled</i> or <i>Disabled</i> .
<i>Triggers</i>	Filter items with (or without) triggers.
<i>Inherited</i>	Filter items inherited (or not inherited) from a template.
<i>Discovery</i>	Filter items discovered (or not discovered) by low-level discovery.

Using subfilter

The subfilter allows to further modify the filtering from the main filter.

It contains clickable links for a quick access to related items. Items are related by common entity - tag, item type, item state, item

update interval, etc. When an entity is clicked, the entity is highlighted with a gray background, and items are immediately filtered (no need to click *Apply* in the main filter). Clicking another entity adds it to the filtered results. Clicking the entity again removes the filtering.

Subfilter affects only filtered data

TAGS
[component: application](#) 1 [component: cpu](#) 17 [component: data-collector](#) 15 [component: environment](#) 1 [component: internal-process](#) 24 [component: memory](#) 7 [component: network](#) 9
[disk: sda](#) 8 [filesystem: /](#) 7 [filesystem: /var/snap/firefox/common/host-hunspell](#) 7 [fstype: ext4](#) 14 [interface: enp0s3](#) 9

TYPES
[Zabbix agent](#) 50 [Zabbix internal](#) 68 [Calculated](#) 2 [Dependent item](#) 22

TYPE OF INFORMATION
[Numeric \(float\)](#) 88 [Character](#) 8 [Numeric \(unsigned\)](#) 40 [Text](#) 6

STATE
[Normal](#) 131 [Not supported](#) 11

TEMPLATE
[Not inherited items](#) 32 [Inherited items](#) 110

WITH TRIGGERS
[Without triggers](#) 59 [With triggers](#) 83

DISCOVERY
[Regular](#) 110 [Discovered](#) 32

HISTORY
[0](#) 4 [1h](#) 2 [1w](#) 136

TRENDS
[0](#) 4 [52w](#) 1d 124

INTERVAL
[30s](#) 1 [1m](#) 100 [3m](#) 6 [5m](#) 1 [15m](#) 3 [1h](#) 9

Subfilters are generated based on the filtered data, which is limited to 1000 records. If you want to see more records in the subfilter, you need to increase the value of *Limit for search and filter results* parameter (in *Administration* -> *General* -> *GUI*).

Unlike the main filter, the subfilter is updated with each table refresh request to always have up-to-date information of available filtering options and their counter numbers.

The number of entities displayed is limited to 100 horizontally. If there are more, a three-dot icon is displayed at the end; it is not clickable.

A number next to each clickable entity indicates the number of items grouped in it (based on the results of the main filter). When an entity is clicked, the numbers with other available entities are displayed with a plus sign indicating how many items may be added to the current selection. Entities without items are not displayed unless selected in the subfilter before.

2 Triggers

Overview

The trigger list for a host can be accessed from *Data collection* → *Hosts* by clicking on *Triggers* for the respective host.

Triggers ? Create trigger

All hosts / Zabbix server Enabled [ZBX](#) [SNMP](#) [IPMI](#) [JMX](#) Items 142 Triggers 67 Graphs 27 Discovery rules 3 Web scenarios 1 Filter

Severity	Value	Name	Operational data	Expression	Status	Info	Tags
Average	OK	Mounted filesystem discovery: /: Disk space is critically low (used > {SVFS.FS.PUSED.MAX.CRIT:"7"}%)	Space used: {ITEM.LASTVALUE3} of {ITEM.LASTVALUE2} ({ITEM.LASTVALUE1})	<code>last(Zabbix server/vfs.fs.size[/,pused])>{SVFS.FS.PUSED.MAX.CRIT:"7"} and ((last(Zabbix server/vfs.fs.size[/,total])-last(Zabbix server/vfs.fs.size[/,used]))<5G or timeleft(Zabbix server/vfs.fs.size[/,pused],1h,100)<1d)</code>	Enabled		
Warning	OK	Mounted filesystem discovery: /: Disk space is low (used > {SVFS.FS.PUSED.MAX.WARN:"7"}%) Depends on: Zabbix server: /: Disk space is critically low (used > {SVFS.FS.PUSED.MAX.CRIT:"7"}%)	Space used: {ITEM.LASTVALUE3} of {ITEM.LASTVALUE2} ({ITEM.LASTVALUE1})	<code>last(Zabbix server/vfs.fs.size[/,pused])>{SVFS.FS.PUSED.MAX.WARN:"7"} and ((last(Zabbix server/vfs.fs.size[/,total])-last(Zabbix server/vfs.fs.size[/,used]))<10G or timeleft(Zabbix server/vfs.fs.size[/,pused],1h,100)<1d)</code>	Enabled		
Average	OK	Mounted filesystem discovery: /: Running out of free inodes (free < {SVFS.FS.INODE.PFREE.MIN.CRIT:"7"}%)	Free inodes: {ITEM.LASTVALUE1}	<code>min(Zabbix server/vfs.fs.inode[/,pfree],5m)<{SVFS.FS.INODE.PFREE.MIN.CRIT:"7"}</code>	Enabled		
Warning	OK	Mounted filesystem discovery: /: Running out of free inodes (free < {SVFS.FS.INODE.PFREE.MIN.WARN:"7"}%) Depends on: Zabbix server: /: Running out of free inodes (free < {SVFS.FS.INODE.PFREE.MIN.CRIT:"7"}%)	Free inodes: {ITEM.LASTVALUE1}	<code>min(Zabbix server/vfs.fs.inode[/,pfree],5m)<{SVFS.FS.INODE.PFREE.MIN.WARN:"7"}</code>	Enabled		
Information	OK	Template Module Linux generic by Zabbix agent: /etc/passwd has been changed Depends on: Zabbix server: Operating system description has changed Zabbix server: System name has changed (new name: {ITEM.VALUE})		<code>(last(Zabbix server/vfs.file.cksum[/etc/passwd],#1)<>last(Zabbix server/vfs.file.cksum[/etc/passwd],#2))>0</code>	Enabled		

Displayed data:

Column	Description
<i>Severity Value</i>	Severity of the trigger is displayed by both name and cell background color. Trigger value is displayed: OK - the trigger is in the OK state PROBLEM - the trigger is in the Problem state
<i>Host</i>	Host of the trigger. Clicking on the host name opens the host configuration form .
<i>Name</i>	This column is displayed only if multiple hosts or no hosts are selected in the filter. Name of the trigger, displayed as a blue link to trigger details. Clicking on the trigger name link opens the trigger configuration form . If the host trigger belongs to a template, the template name is displayed before the trigger name, as a gray link. Clicking on the template link will open the trigger list on the template level. If the trigger has been created from a trigger prototype, its name is preceded by the low-level discovery rule name, in orange. Clicking on the discovery rule name will open the trigger prototype list.
<i>Operational data</i>	Operational data definition of the trigger, containing arbitrary strings and macros that will resolve dynamically in <i>Monitoring</i> → <i>Problems</i> .
<i>Expression</i>	Trigger expression is displayed. The host-item part of the expression is displayed as a link, leading to the item configuration form.
<i>Status</i>	Trigger status is displayed - <i>Enabled</i> , <i>Disabled</i> or <i>Unknown</i> . By clicking on the status you can manually change it - from Enabled to Disabled (and back); from Unknown to Disabled (and back). Problems of a disabled trigger are no longer displayed in the frontend, but are not deleted. Discovered triggers that have been lost are marked with an info icon. The tooltip text provides details on their status.
<i>Info</i>	If everything is working correctly, no icon is displayed in this column. In case of errors, a square icon with the letter "i" is displayed. Hover over the icon to see a tooltip with the error description.
<i>Tags</i>	If a trigger contains tags, tag name and value are displayed in this column.

To configure a new trigger, click on the *Create trigger* button at the top right corner.

Mass editing options

Buttons below the list offer some mass-editing options:

- *Enable* - change trigger status to *Enabled*.
- *Disable* - change trigger status to *Disabled*.
- *Copy* - copy the triggers to other hosts or templates.
- *Mass update* - update several properties for a number of triggers at once.
- *Delete* - delete the triggers.

To use these options, mark the checkboxes before the respective triggers, then click on the required button.

Using filter

You can use the filter to display only the triggers you are interested in. For better search performance, data is searched with macros unresolved.

The *Filter* icon is available at the top right corner. Clicking on it will open a filter where you can specify the desired filtering criteria.

Parameter	Description
<i>Host groups</i>	Filter by one or more host groups. Specifying a parent host group implicitly selects all nested host groups. Host groups containing templates only cannot be selected.
<i>Hosts</i>	Filter by one or more hosts. If host groups are already selected above, host selection is limited to those groups.

Parameter	Description
<i>Name</i>	Filter by trigger name.
<i>Severity</i>	Select to filter by one or several trigger severities.
<i>State</i>	Filter by trigger state.
<i>Status</i>	Filter by trigger status.
<i>Value</i>	Filter by trigger value.
<i>Tags</i>	Filter by trigger tag name and value. It is possible to include as well as exclude specific tags and tag values. Several conditions can be set. Tag name matching is always case-sensitive. There are several operators available for each condition: Exists - include the specified tag names Equals - include the specified tag names and values (case-sensitive) Contains - include the specified tag names where the tag values contain the entered string (substring match, case-insensitive) Does not exist - exclude the specified tag names Does not equal - exclude the specified tag names and values (case-sensitive) Does not contain - exclude the specified tag names where the tag values contain the entered string (substring match, case-insensitive) There are two calculation types for conditions: And/Or - all conditions must be met, conditions having the same tag name will be grouped by the Or condition Or - enough if one condition is met Macros and macro functions are supported both in tag name and tag value fields.
<i>Inherited</i>	Filter triggers inherited (or not inherited) from a template.
<i>Discovered</i>	Filter triggers discovered (or not discovered) by low-level discovery.
<i>With dependencies</i>	Filter triggers with (or without) dependencies.

3 Graphs

Overview

The custom graph list for a host can be accessed from *Data collection* → *Hosts* by clicking on *Graphs* for the respective host.

A list of existing graphs is displayed.

Name	Width	Height	Graph type	Info
Mounted filesystem discovery: /: Disk space usage	600	340	Pie	
Template Module Linux CPU by Zabbix agent: CPU jumps	900	200	Normal	
Template Module Linux CPU by Zabbix agent: CPU usage	900	200	Stacked	
Template Module Linux CPU by Zabbix agent: CPU utilization	900	200	Normal	
Network interface discovery: Interface enp4s0: Network traffic	900	200	Normal	
Network interface discovery: Interface ppp0: Network traffic	900	200	Normal	i
Network interface discovery: Interface wlp3s0: Network traffic	900	200	Normal	
Template Module Linux memory by Zabbix agent: Memory usage	900	200	Normal	
Template Module Linux memory by Zabbix agent: Memory utilization	900	200	Normal	
Template Module Linux generic by Zabbix agent: Processes	900	200	Normal	
Block devices discovery: sda: Disk average waiting time	900	200	Normal	
Block devices discovery: sda: Disk read/write rates	900	200	Normal	

Displayed data:

Column	Description
<i>Host</i>	Host of the graph. Clicking on the host name opens the host configuration form . This column is displayed only if multiple hosts or no hosts are selected in the filter.

Column	Description
<i>Name</i>	Name of the custom graph, displayed as a blue link to graph details. Clicking on the graph name link opens the graph configuration form . If the host graph belongs to a template, the template name is displayed before the graph name, as a gray link. Clicking on the template link will open the graph list on the template level. If the graph has been created from a graph prototype, its name is preceded by the low-level discovery rule name, in orange. Clicking on the discovery rule name will open the graph prototype list.
<i>Width</i>	Graph width is displayed.
<i>Height</i>	Graph height is displayed.
<i>Graph type</i>	Graph type is displayed - <i>Normal</i> , <i>Stacked</i> , <i>Pie</i> or <i>Exploded</i> .
<i>Info</i>	If the graph is working correctly, no icon is displayed in this column. In case of errors, a square icon with the letter "i" is displayed. Hover over the icon to see a tooltip with the error description.

To configure a new graph, click on the *Create graph* button at the top right corner.

Mass editing options

Buttons below the list offer some mass-editing options:

- *Copy* - copy the graphs to other hosts or templates
- *Delete* - delete the graphs

To use these options, mark the checkboxes before the respective graphs, then click on the required button.

Using filter

You can filter graphs by host group and host. For better search performance, data is searched with macros unresolved.

4 Discovery rules

Overview

The list of low-level discovery rules for a host can be accessed from *Data collection* → *Hosts* by clicking on *Discovery* for the respective host.

A list of existing low-level discovery rules is displayed. It is also possible to see all discovery rules independently of the host, or all discovery rules of a specific host group by changing the filter settings.

Displayed data:

Column	Description
<i>Host</i>	The visible host name is displayed. Clicking on the host name opens the host configuration form . In the absence of a visible host name, the technical host name is displayed.
<i>Name</i>	Name of the rule, displayed as a blue link. Clicking on the rule name opens the low-level discovery rule configuration form . If the discovery rule belongs to a template, the template name is displayed before the rule name, as a gray link. Clicking on the template link will open the rule list on the template level.
<i>Items</i>	A link to the list of item prototypes is displayed.
<i>Triggers</i>	The number of existing item prototypes is displayed in gray. A link to the list of trigger prototypes is displayed.
	The number of existing trigger prototypes is displayed in gray.

Column	Description
<i>Graphs</i>	A link to the list of graph prototypes is displayed. The number of existing graph prototypes is displayed in gray.
<i>Hosts</i>	A link to the list of host prototypes is displayed. The number of existing host prototypes is displayed in gray.
<i>Key</i>	The item key used for discovery is displayed.
<i>Interval</i>	The frequency of performing discovery is displayed. <i>Note</i> that discovery can also be performed immediately by pushing the <i>Execute now</i> button below the list.
<i>Type</i>	The item type used for discovery is displayed (Zabbix agent, SNMP agent, etc).
<i>Status</i>	Discovery rule status is displayed - <i>Enabled</i> , <i>Disabled</i> or <i>Not supported</i> . By clicking on the status you can change it - from Enabled to Disabled (and back); from Not supported to Disabled (and back).
<i>Info</i>	If everything is fine, no icon is displayed in this column. In case of errors, a square icon with the letter "i" is displayed. Hover over the icon to see a tooltip with the error description.

To configure a new low-level discovery rule, click on the *Create discovery rule* button at the top right corner.

Mass editing options

Buttons below the list offer some mass-editing options:

- *Enable* - change the low-level discovery rule status to *Enabled*.
- *Disable* - change the low-level discovery rule status to *Disabled*.
- *Execute now* - perform discovery based on the discovery rules immediately. See [more details](#). Note that when performing discovery immediately, the configuration cache is not updated, thus the result will not reflect very recent changes to discovery rule configuration.
- *Delete* - delete the low-level discovery rules.

To use these options, mark the checkboxes before the respective discovery rules, then click on the required button.

Using filter

You can use the filter to display only the discovery rules you are interested in. For better search performance, data is searched with macros unresolved.

The *Filter* link is available above the list of discovery rules. If you click on it, a filter becomes available where you can filter discovery rules by host group, host, name, item key, item type, and other parameters.

Parameter	Description
<i>Host groups</i>	Filter by one or more host groups. Specifying a parent host group implicitly selects all nested host groups.
<i>Hosts</i>	Filter by one or more hosts.
<i>Name</i>	Filter by discovery rule name.
<i>Key</i>	Filter by discovery item key.
<i>Type</i>	Filter by discovery item type.
<i>Update interval</i>	Filter by update interval.
<i>Delete lost resources</i>	Not available for Zabbix trapper and dependent items. Filter by <i>Delete lost resources</i> period.
<i>Disable lost resources</i>	Filter by <i>Disable lost resources</i> period.
<i>SNMP OID</i>	Filter by SNMP OID.
<i>State</i>	Only available if <i>SNMP agent</i> is selected as type. Filter by discovery rule state (All/Normal/Not supported).
<i>Status</i>	Filter by discovery rule status (All/Enabled/Disabled).

1 Item prototypes

Overview

In this section the item prototypes of a low-level discovery rule on the host are displayed. Item prototypes are the basis of real host **items** that are created during low-level discovery.

☰ Item prototypes ? Create item prototype

	Name	Key	Interval	History	Trends	Type	Create enabled	Discover	Tags
<input type="checkbox"/>	Linux by Zabbix agent: (#DEVNAME): Get stats: (#DEVNAME): Disk average queue size (avgqu-sz)	vfs.dev.queue_size[#{DEVNAME}]	7d	365d	Dependent item	Yes	Yes	component: storage disk: [#{DEVNAME}]	
<input type="checkbox"/>	Linux by Zabbix agent: (#DEVNAME): Get stats: (#DEVNAME): Disk read rate	vfs.dev.read.rate[#{DEVNAME}]	7d	365d	Dependent item	Yes	Yes	component: storage disk: [#{DEVNAME}]	
<input type="checkbox"/>	Linux by Zabbix agent: (#DEVNAME): Disk read request avg waiting time (r_await)	vfs.dev.read.await[#{DEVNAME}]	1m	7d	Calculated	Yes	Yes	component: storage disk: [#{DEVNAME}]	
<input type="checkbox"/>	Linux by Zabbix agent: (#DEVNAME): Get stats: (#DEVNAME): Disk read time (rate)	vfs.dev.read.time.rate[#{DEVNAME}]	7d	365d	Dependent item	Yes	Yes	component: storage disk: [#{DEVNAME}]	
<input type="checkbox"/>	Linux by Zabbix agent: (#DEVNAME): Get stats: (#DEVNAME): Disk utilization	vfs.dev.util[#{DEVNAME}]	7d	365d	Dependent item	Yes	Yes	component: storage disk: [#{DEVNAME}]	
<input type="checkbox"/>	Linux by Zabbix agent: (#DEVNAME): Get stats: (#DEVNAME): Disk write rate	vfs.dev.write.rate[#{DEVNAME}]	7d	365d	Dependent item	Yes	Yes	component: storage disk: [#{DEVNAME}]	
<input type="checkbox"/>	Linux by Zabbix agent: (#DEVNAME): Disk write request avg waiting time (w_await)	vfs.dev.write.await[#{DEVNAME}]	1m	7d	Calculated	Yes	Yes	component: storage disk: [#{DEVNAME}]	
<input type="checkbox"/>	Linux by Zabbix agent: (#DEVNAME): Get stats: (#DEVNAME): Disk write time (rate)	vfs.dev.write.time.rate[#{DEVNAME}]	7d	365d	Dependent item	Yes	Yes	component: storage disk: [#{DEVNAME}]	
<input type="checkbox"/>	Linux by Zabbix agent: (#DEVNAME): Get stats	vfs.file.contents[sys/block/#{DEVNAME}/stat]	1m	0	Zabbix agent	Yes	Yes	component: raw	

0 selected

Displaying 9 of 9 found

Displayed data:

Column	Description
<i>Name</i>	Name of the item prototype, displayed as a blue link. Clicking on the name opens the item prototype configuration form . If the item prototype belongs to a template, the template name is displayed before the rule name, as a gray link. Clicking on the template link will open the item prototype list on the template level.
<i>Key</i>	Key of the item prototype is displayed.
<i>Interval</i>	Frequency of the check is displayed.
<i>History</i>	How many days to keep item data history is displayed.
<i>Trends</i>	How many days to keep item trends history is displayed.
<i>Type</i>	Type of the item prototype is displayed (Zabbix agent, SNMP agent, simple check, etc).
<i>Create enabled</i>	Create the item based on this prototype as: Yes - enabled No - disabled. You can switch between 'Yes' and 'No' by clicking on them.
<i>Discover</i>	Discover the item based on this prototype: Yes - discover No - do not discover. You can switch between 'Yes' and 'No' by clicking on them.
<i>Tags</i>	Tags of the item prototype are displayed.

To configure a new item prototype, click on the *Create item prototype* button at the top right corner.

Mass editing options

Buttons below the list offer some mass-editing options:

- *Create enabled* - create these items as *Enabled*
- *Create disabled* - create these items as *Disabled*
- *Mass update* - mass update these item prototypes
- *Delete* - delete these item prototypes

To use these options, mark the checkboxes before the respective item prototypes, then click on the required button.

2 Trigger prototypes

Overview

In this section the trigger prototypes of a low-level discovery rule on the host are displayed. Trigger prototypes are the basis of real host **triggers** that are created during low-level discovery.

All hosts / Zabbix server Enabled ZBX SNMP IPMI Discovery list / Network interface discovery

Item prototypes 8 Trigger prototypes 3 Graph prototypes 1 Host prototypes

Severity	Name	Operational data	Expression	Create enabled	Discover	Tags
Information	Template Module Linux network interfaces by Zabbix agent: Interface {#IFNAME}: Ethernet has changed to lower speed than it was before Depends on: Zabbix server: Interface {#IFNAME}: Link down	Current reported speed: {ITEM.LASTVALUE1}	Problem: <code>change((Zabbix server/vfs.file.contents["/sys/class/net/{#IFNAME}/type"])<0 and last((Zabbix server/vfs.file.contents["/sys/class/net/{#IFNAME}/type"])>0 and (last((Zabbix server/vfs.file.contents["/sys/class/net/{#IFNAME}/type"])>6 or last((Zabbix server/vfs.file.contents["/sys/class/net/{#IFNAME}/type"])=1) and (last((Zabbix server/vfs.file.contents["/sys/class/net/{#IFNAME}/operstate"])<-2)</code> Recovery: <code>(change((Zabbix server/vfs.file.contents["/sys/class/net/{#IFNAME}/type"])>0 and last((Zabbix server/vfs.file.contents["/sys/class/net/{#IFNAME}/type"],#2)>0) or (last((Zabbix server/vfs.file.contents["/sys/class/net/{#IFNAME}/operstate"])<-2)</code>	Yes	Yes	
Warning	Template Module Linux network interfaces by Zabbix agent: Interface {#IFNAME}: High error rate (> {#IFERRORS.WARN:"{#IFNAME}"}) for 5m Depends on: Zabbix server: Interface {#IFNAME}: Link down	errors in: {ITEM.LASTVALUE1}, errors out: {ITEM.LASTVALUE2}	Problem: <code>min((Zabbix server/net.if.in["{#IFNAME}","errors],5m)>{#IFERRORS.WARN:"{#IFNAME}"}) or min((Zabbix server/net.if.out["{#IFNAME}","errors],5m)>{#IFERRORS.WARN:"{#IFNAME}"})</code> Recovery: <code>max((Zabbix server/net.if.in["{#IFNAME}","errors],5m)<{#IFERRORS.WARN:"{#IFNAME}"})*0.8 and max((Zabbix server/net.if.out["{#IFNAME}","errors],5m)<{#IFERRORS.WARN:"{#IFNAME}"})*0.8</code>	Yes	Yes	
Average	Template Module Linux network interfaces by Zabbix agent: Interface {#IFNAME}: Link down	Current state: {ITEM.LASTVALUE1}	Problem: <code>{#IFCONTROL:"{#IFNAME}"}=1 and (last((Zabbix server/vfs.file.contents["/sys/class/net/{#IFNAME}/operstate"])=2 and (last((Zabbix server/vfs.file.contents["/sys/class/net/{#IFNAME}/operstate"],#1)<-last((Zabbix server/vfs.file.contents["/sys/class/net/{#IFNAME}/operstate"],#2))=1)</code> Recovery: <code>last((Zabbix server/vfs.file.contents["/sys/class/net/{#IFNAME}/operstate"])<-2</code>	Yes	Yes	

0 selected Create enabled Create disabled Mass update Delete

Displaying 3 of 3 found

Displayed data:

Column	Description
Name	Name of the trigger prototype, displayed as a blue link. Clicking on the name opens the trigger prototype configuration form . If the trigger prototype belongs to a linked template, the template name is displayed before the trigger name, as a gray link. Clicking on the template link will open the trigger prototype list on the linked template level.
Operational data	Format of the operational data of the trigger is displayed, containing arbitrary strings and macros that will resolve dynamically in <i>Monitoring</i> → <i>Problems</i> .
Create enabled	Create the trigger based on this prototype as: Yes - enabled No - disabled. You can switch between 'Yes' and 'No' by clicking on them.
Discover	Discover the trigger based on this prototype: Yes - discover No - do not discover. You can switch between 'Yes' and 'No' by clicking on them.
Tags	Tags of the trigger prototype are displayed.

To configure a new trigger prototype, click on the *Create trigger prototype* button at the top right corner.

Mass editing options

Buttons below the list offer some mass-editing options:

- *Create enabled* - create these triggers as *Enabled*
- *Create disabled* - create these triggers as *Disabled*
- *Mass update* - mass update these trigger prototypes
- *Delete* - delete these trigger prototypes

To use these options, mark the checkboxes before the respective trigger prototypes, then click on the required button.

3 Graph prototypes

Overview

In this section the graph prototypes of a low-level discovery rule on the host are displayed. Graph prototypes are the basis of real host **graphs** that are created during low-level discovery.

☰ Graph prototypes ? Create graph prototype

All hosts / Zabbix server Enabled ZBX SNMP IPMI Discovery list / Network interface discovery

Item prototypes 8 Trigger prototypes 3 Graph prototypes 1 Host prototypes

<input type="checkbox"/> Name ▲	Width	Height	Graph type	Discover
<input type="checkbox"/> Template Module Linux network interfaces by Zabbix agent: Interface {#IFNAME}: Network traffic	900	200	Normal	Yes

0 selected

Displayed data:

Column	Description
<i>Name</i>	Name of the graph prototype, displayed as a blue link. Clicking on the name opens the graph prototype configuration form . If the graph prototype belongs to a linked template, the template name is displayed before the graph name, as a gray link. Clicking on the template link will open the graph prototype list on the linked template level.
<i>Width</i>	Width of the graph prototype is displayed.
<i>Height</i>	Height of the graph prototype is displayed.
<i>Type</i>	Type of the graph prototype is displayed - <i>Normal, Stacked, Pie</i> or <i>Exploded</i> .
<i>Discover</i>	Discover the graph based on this prototype: Yes - discover No - do not discover. You can switch between 'Yes' and 'No' by clicking on them.

To configure a new graph prototype, click on the *Create graph prototype* button at the top right corner.

Mass editing options

Buttons below the list offer some mass-editing options:

- *Delete* - delete these graph prototypes

To use these options, mark the checkboxes before the respective graph prototypes, then click on the required button.

4 Host prototypes

Overview

In this section the host prototypes of a low-level discovery rule on the host are displayed. Host prototypes are the basis of real **hosts** that are created during low-level discovery.

☰ Host prototypes ? Create host prototype

All hosts / Server1 Enabled ZBX Discovery list / Discover VMware VMs Item prototypes Trigger prototypes Graph prototypes Host prototypes 1

<input type="checkbox"/> Name ▲	Templates	Create enabled	Discover	Tags
<input type="checkbox"/> Template VM VMware: {#VM.NAME}	Template VM VMware Guest	Yes	Yes	

0 selected

Displayed data:

Column	Description
<i>Name</i>	Name of the host prototype, displayed as a blue link. Clicking on the name opens the host prototype configuration form. If the host prototype belongs to a linked template, the template name is displayed before the host name, as a gray link. Clicking on the template link will open the host prototype list on the linked template level.
<i>Templates</i>	Templates of the host prototype are displayed.
<i>Create enabled</i>	Create the host based on this prototype as: Yes - enabled No - disabled. You can switch between 'Yes' and 'No' by clicking on them.
<i>Discover</i>	Discover the host based on this prototype: Yes - discover No - do not discover. You can switch between 'Yes' and 'No' by clicking on them.

Column	Description
Tags	Tags of the host prototype are displayed.

To configure a new host prototype, click on the *Create host prototype* button at the top right corner.

Mass editing options

Buttons below the list offer some mass-editing options:

- *Create enabled* - create these hosts as *Enabled*
- *Create disabled* - create these hosts as *Disabled*
- *Delete* - delete these host prototypes

To use these options, mark the checkboxes before the respective host prototypes, then click on the required button.

5 Web scenarios

Overview

The **web scenario** list for a host can be accessed from *Data collection* → *Hosts* by clicking on *Web* for the respective host.

A list of existing web scenarios is displayed.

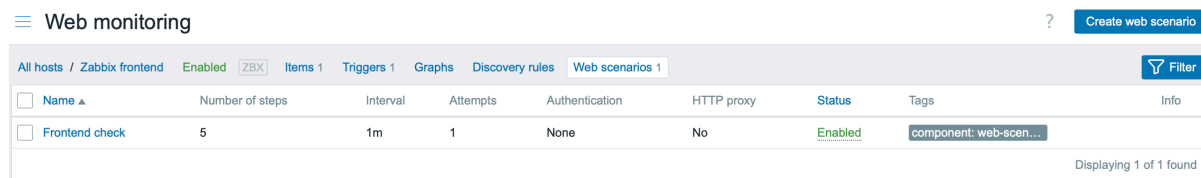

Displayed data:

Column	Description
<i>Name</i>	Name of the web scenario. Clicking on the web scenario name opens the web scenario configuration form . If the host web scenario belongs to a template, the template name is displayed before the web scenario name as a gray link. Clicking on the template link will open the web scenario list on the template level.
<i>Number of steps</i>	The number of steps the scenario contains.
<i>Update interval</i>	How often the scenario is performed.
<i>Attempts</i>	How many attempts for executing web scenario steps are performed.
<i>Authentication</i>	Authentication method is displayed - Basic, NTLM, or None.
<i>HTTP proxy</i>	Displays HTTP proxy or 'No' if not used.
<i>Status</i>	Web scenario status is displayed - <i>Enabled</i> or <i>Disabled</i> . By clicking on the status you can change it.
<i>Tags</i>	Web scenario tags are displayed. Up to three tags (name:value pairs) can be displayed. If there are more tags, a "..." link is displayed that allows to see all tags on mouseover.
<i>Info</i>	If everything is working correctly, no icon is displayed in this column. In case of errors, a square icon with the letter "i" is displayed. Hover over the icon to see a tooltip with the error description.

To configure a new web scenario, click on the *Create web scenario* button at the top right corner.

Mass editing options

Buttons below the list offer some mass-editing options:

- *Enable* - change the scenario status to *Enabled*
- *Disable* - change the scenario status to *Disabled*
- *Clear history and trends* - clear history and trend data for the scenarios
- *Delete* - delete the web scenarios

To use these options, mark the checkboxes before the respective web scenarios, then click on the required button.

Using filter

You can use the filter to display only the scenarios you are interested in. For better search performance, data is searched with macros unresolved.

The *Filter* link is available above the list of web scenarios. If you click on it, a filter becomes available where you can filter scenarios by host group, host, status and tags.

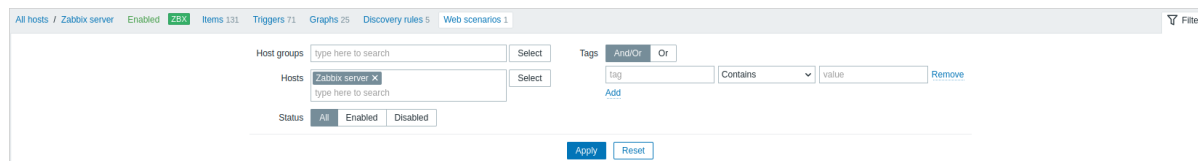

5 Maintenance

Overview

In the *Data collection* → *Maintenance* section users can configure and maintain maintenance periods for hosts.

A listing of existing maintenance periods with their details is displayed.

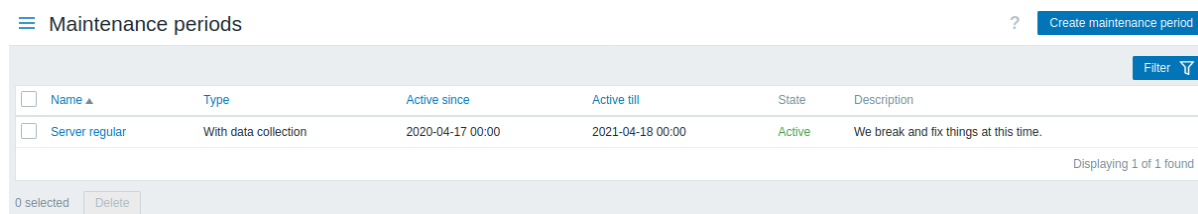

Displayed data:

Column	Description
<i>Name</i>	Name of the maintenance period. Clicking on the maintenance period name opens the maintenance period configuration form .
<i>Type</i>	The type of maintenance is displayed: <i>With data collection</i> or <i>No data collection</i>
<i>Active since</i>	The date and time when executing maintenance periods becomes active. Note: This time does not activate a maintenance period; maintenance periods need to be set separately.
<i>Active till</i>	The date and time when executing maintenance periods stops being active.
<i>State</i>	The state of the maintenance period: Approaching - will become active soon Active - is active Expired - is not active any more
<i>Description</i>	Description of the maintenance period is displayed.

To configure a new maintenance period, click on the *Create maintenance period* button in the top right-hand corner.

Mass editing options

A button below the list offers one mass-editing option:

- *Delete* - delete the maintenance periods

To use this option, mark the checkboxes before the respective maintenance periods and click on *Delete*.

Using filter

You can use the filter to display only the maintenance periods you are interested in. For better search performance, data is searched with macros unresolved.

The *Filter* link is available above the list of maintenance periods. If you click on it, a filter becomes available where you can filter maintenance periods by host group, name and state.

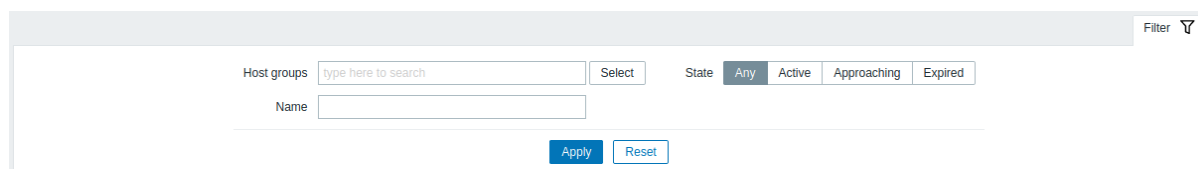

6 Event correlation

Overview

In the *Data collection* → *Event correlation* section users can configure and maintain global correlation rules for Zabbix events.

Name	Conditions	Operations	Status
<input type="checkbox"/> Close old events	Value of old event tag application equals value of new event tag application Value of old event tag application equals abc Value of old event tag status equals down Value of new event tag status equals up	Close old events	Enabled
<input type="checkbox"/> Correlate network port problems	Value of old event tag host equals value of new event tag host Value of old event tag port equals value of new event tag port	Close new event	Enabled

Displayed data:

Column	Description
<i>Name</i>	Name of the correlation rule. Clicking on the correlation rule name opens the rule configuration form .
<i>Conditions</i>	Correlation rule conditions are displayed.
<i>Operations</i>	Correlation rule operations are displayed.
<i>Status</i>	Correlation rule status is displayed - <i>Enabled</i> or <i>Disabled</i> . By clicking on the status you can change it.

To configure a new correlation rule, click on the *Create event correlation* button in the top right-hand corner.

Mass editing options

Buttons below the list offer some mass-editing options:

- *Enable* - change the correlation rule status to *Enabled*
- *Disable* - change the correlation rule status to *Disabled*
- *Delete* - delete the correlation rules

To use these options, mark the checkboxes before the respective correlation rules, then click on the required button.

Using filter

You can use the filter to display only the correlation rules you are interested in. For better search performance, data is searched with macros unresolved.

The *Filter* link is available above the list of correlation rules. If you click on it, a filter becomes available where you can filter correlation rules by name and status.

Name	Status
<input type="text"/>	<input type="button" value="Any"/> <input type="button" value="Enabled"/> <input type="button" value="Disabled"/>

7 Discovery

Overview

In the *Data collection* → *Discovery* section users can configure and maintain discovery rules.

A listing of existing discovery rules with their details is displayed.

Discovery rules ? [Create discovery rule](#)

Name	IP range	Proxy	Interval	Checks	Status	Info
<input type="checkbox"/> Local network	192.168.6.1-254		1h	HTTP, HTTPS, Zabbix agent	Enabled	

0 selected [Enable](#) [Disable](#) [Delete](#) Filter

Displayed data:

Column	Description
<i>Name</i>	Name of the discovery rule. Clicking on the discovery rule name opens the discovery rule configuration form .
<i>IP range</i>	The range of IP addresses to use for network scanning is displayed.
<i>Proxy</i>	The proxy name is displayed, if discovery is performed by the proxy.
<i>Interval</i>	The frequency of performing discovery displayed.
<i>Checks</i>	The types of checks used for discovery are displayed.
<i>Status</i>	The discovery rule status is displayed - <i>Enabled</i> or <i>Disabled</i> . By clicking on the status you can change it.
<i>Info</i>	If everything is working correctly, nothing is displayed in this column. In case of errors, a red info icon with the letter "i" is displayed. Hover over the icon to see a tooltip with the error description.

To configure a new discovery rule, click on the *Create discovery rule* button in the top right-hand corner.

Mass editing options

Buttons below the list offer some mass-editing options:

- *Enable* - change the discovery rule status to *Enabled*
- *Disable* - change the discovery rule status to *Disabled*
- *Delete* - delete the discovery rules

To use these options, mark the checkboxes before the respective discovery rules, then click on the required button.

Using filter

You can use the filter to display only the discovery rules you are interested in. For better search performance, data is searched with macros unresolved.

The *Filter* link is available above the list of discovery rules. If you click on it, a filter becomes available where you can filter discovery rules by name and status.

Filter

Name

Status Any Enabled Disabled

Apply
Reset

7 Alerts

Overview

This menu features sections that are related to configuring alerts in Zabbix.

1 Actions

Overview

In the *Alerts* → *Actions* section users can configure and maintain actions.

The actions displayed are actions assigned to the selected event source (trigger, services, discovery, autoregistration, internal actions).

To switch to a different event source, click on *Actions* in the *Alerts* menu section. It is also possible to switch between sources by using the title dropdown in the top left corner.

Name	Conditions	Operations	Status
<input type="checkbox"/> Report problems to Zabbix administrators		Send message to user groups: Zabbix administrators via Email Send message to user groups: Managers via SMS Run remote commands on current host	Enabled

Displayed data:

Column	Description
<i>Name</i>	Name of the action. Clicking on the action name opens the action configuration form .
<i>Conditions</i>	Action conditions are displayed.
<i>Operations</i>	Action operations are displayed. The operation list also displays the media type (email, SMS or script) used for notification as well as the name and surname (in parentheses after the username) of a notification recipient. Action operation can both be a notification or a remote command depending on the selected type of operation.
<i>Status</i>	Action status is displayed - <i>Enabled</i> or <i>Disabled</i> . By clicking on the status you can change it. See the Escalations section for more details as to what happens if an action is disabled during an escalation in progress.

To configure a new action, click on the *Create action* button in the top right-hand corner.

For users without Super admin rights actions are displayed according to the permission settings. That means in some cases a user without Super admin rights isn't able to view the complete action list because of certain permission restrictions. An action is displayed to the user without Super admin rights if the following conditions are fulfilled:

- The user has read-write access to host groups, hosts, templates, and triggers in action conditions
- The user has read-write access to host groups, hosts, and templates in action operations, recovery operations, and update operations
- The user has read access to user groups and users in action operations, recovery operations, and update operations

Mass editing options

Buttons below the list offer some mass-editing options:

- *Enable* - change the action status to *Enabled*
- *Disable* - change the action status to *Disabled*
- *Delete* - delete the actions

To use these options, mark the checkboxes before the respective actions, then click on the required button.

Using filter

You can use the filter to display only the actions you are interested in. For better search performance, data is searched with macros unresolved.

The *Filter* link is available above the list of actions. If you click on it, a filter becomes available where you can filter actions by name and status.

Name

Status Any Enabled Disabled

2 Media types

Overview

In the *Alerts* → *Media types* section users can configure and maintain media type information.

Media type information contains general instructions for using a medium as delivery channel for notifications. Specific details, such as the individual email addresses to send a notification to are kept with individual users.

A listing of existing media types with their details is displayed.

Media types ? Create media type Import

Name	Type	Status	Used in actions	Details	Action
Brevis.one	Webhook	Disabled	4 Report not supported items, Report not supported low level discovery rules, Report problems to Zabbix administrators, Report unknown triggers		Test
Discord	Webhook	Disabled	4 Report not supported items, Report not supported low level discovery rules, Report problems to Zabbix administrators, Report unknown triggers		Test
Email	Email	Enabled	4 Report not supported items, Report not supported low level discovery rules, Report problems to Zabbix administrators, Report unknown triggers	SMTP server: "mail.example.com", SMTP helo: "example.com", email: "zabbix@example.com"	Test
Email (HTML)	Email	Enabled	4 Report not supported items, Report not supported low level discovery rules, Report problems to Zabbix administrators, Report unknown triggers	SMTP server: "mail.example.com", SMTP helo: "example.com", email: "zabbix@example.com"	Test
Event-Driven Ansible	Webhook	Disabled	4 Report not supported items, Report not supported low level discovery rules, Report problems to Zabbix administrators, Report unknown triggers		Test
Express.ms	Webhook	Disabled	4 Report not supported items, Report not supported low level discovery rules, Report problems to Zabbix administrators, Report unknown triggers		Test
Github	Webhook	Disabled	4 Report not supported items, Report not supported low level discovery rules, Report problems to Zabbix administrators, Report unknown triggers		Test
GLPI	Webhook	Disabled	4 Report not supported items, Report not supported low level discovery rules, Report problems to Zabbix administrators, Report unknown triggers		Test
Gmail	Email	Disabled	4 Report not supported items, Report not supported low level discovery rules, Report problems to Zabbix administrators, Report unknown triggers	SMTP server: "smtp.gmail.com", email: "zabbix@example.com"	Test

Displayed data:

Column	Description
<i>Name</i>	Name of the media type. Clicking on the name opens the media type configuration form .
<i>Type</i>	Type of the media (email, SMS, etc) is displayed.
<i>Status</i>	Media type status is displayed - <i>Enabled</i> or <i>Disabled</i> . By clicking on the status you can change it.
<i>Used in actions</i>	Actions where the media type is used are displayed, preceded by the total number of these actions. Clicking on the action name opens the action configuration form. If the user has no permissions to the action, the name is not clickable.
<i>Details</i>	Detailed information of the media type is displayed.
<i>Actions</i>	The following action is available: Test - click to open a testing form where you can enter media type parameters (e.g. a recipient address with test subject and body) and send a test message to verify that the configured media type works. See also: Media type testing for Email , Webhook , or Script .

To configure a new media type, click on the *Create media type* button in the top right-hand corner.

To import a media type, click on the *Import* button in the top right-hand corner.

Mass editing options

Buttons below the list offer some mass-editing options:

- *Enable* - change the media type status to *Enabled*
- *Disable* - change the media type status to *Disabled*
- *Export* - export the media types to a YAML, XML or JSON file
- *Delete* - delete the media types

To use these options, mark the checkboxes before the respective media types, then click on the required button.

Using filter

You can use the filter to display only the media types you are interested in. For better search performance, data is searched with macros unresolved.

The *Filter* link is available above the list of media types. If you click on it, a filter becomes available where you can filter media types by name and status. Additionally, you can use the filter to display actions in the *Used in actions* column based on the scope of their media type usage (defined by the *Send to media type* parameter in action **operation details**).

Filter

Name <input type="text"/>	Status Any Enabled Disabled	Display actions ? All All available Specific
<input type="button" value="Apply"/> <input type="button" value="Reset"/>		

3 Scripts

Overview

In the *Alerts* → *Scripts* section user-defined global scripts can be configured and maintained.

Global scripts, depending on the configured scope and also user permissions, are available for execution:

- from the **host menu** in various frontend locations (*Dashboard*, *Problems*, *Latest data*, *Maps*, etc.)
- from the **event menu**
- can be run as an action operation

The scripts are executed on Zabbix agent, Zabbix server (proxy) or Zabbix server only. See also **Command execution**.

Both on Zabbix agent and Zabbix proxy remote scripts are disabled by default. They can be enabled by:

- For remote commands executed on Zabbix agent:
 - adding an `AllowKey=system.run[<command>,*]` parameter for each allowed command in agent configuration, * stands for wait and nowait mode;
- For remote commands executed on Zabbix proxy:
 - **Warning: It is not required to enable remote commands on Zabbix proxy if remote commands are executed on Zabbix agent that is monitored by Zabbix proxy.** If, however, it is required to execute remote commands on Zabbix proxy, set `EnableRemoteCommands` parameter to '1' in the proxy configuration.

Global script execution on Zabbix server can be disabled by setting `EnableGlobalScripts=0` in server configuration. For new installations, since Zabbix 7.0, global script execution on Zabbix server is disabled by default.

A listing of existing scripts with their details is displayed.

Name	Scope	Used in actions	Type	Execute on	Commands	User group	Host group	Host access
Detect operating system	Manual host action		Script	Server (proxy)	<code>sudo /usr/bin/nmap -O {HOST.CONN}</code>	Zabbix administrators	All	Read
Ping	Manual host action		Script	Server (proxy)	<code>ping -c 3 {HOST.CONN}; case \$? in [01]) true;; *) false;; esac</code>	All	All	Read
Restart apache	Action operation	1 Report problems to Zabbix administrators	Script	Server (proxy)	<code>sudo /etc/init.d/apache restart</code>	All	All	Read
Traceroute	Manual host action		Script	Server (proxy)	<code>/usr/bin/traceroute {HOST.CONN}</code>	All	All	Read

0 selected

Displayed data:

Column	Description
<i>Name</i>	Name of the script. Clicking on the script name opens the script configuration form .
<i>Scope</i>	Scope of the script - action operation, manual host action or manual event action. This setting determines where the script is available.
<i>Used in actions</i>	All actions where the script is used are displayed, preceded by the total number of these actions. Clicking on the action name opens the action configuration form. If the user has no permissions to the action, the name is not clickable.
<i>Type</i>	Script type is displayed - <i>URL</i> , <i>Webhook</i> , <i>Script</i> , <i>SSH</i> , <i>Telnet</i> or <i>IPMI</i> command.
<i>Execute on</i>	It is displayed whether the script will be executed on Zabbix agent, Zabbix proxy or server, or Zabbix server only.
<i>Commands</i>	All commands to be executed within the script are displayed. Nothing is displayed here for webhooks.
<i>User group</i>	The user group that the script is available to is displayed (or <i>All</i> for all user groups).
<i>Host group</i>	The host group that the script is available for is displayed (or <i>All</i> for all host groups).
<i>Host access</i>	The permission level for the host group is displayed - <i>Read</i> or <i>Write</i> . Only users with the required permission level will have access to executing the script.

To configure a new script, click on the *Create script* button in the top right-hand corner.

Mass editing options

A button below the list offers one mass-editing option:

- *Delete* - delete the scripts

To use this option, mark the checkboxes before the respective scripts and click on *Delete*.

Using filter

You can use the filter to display only the scripts you are interested in. For better search performance, data is searched with macros unresolved.

The *Filter* link is available above the list of scripts. If you click on it, a filter becomes available where you can filter scripts by name and scope.

The screenshot shows a filter interface with a search box labeled 'Name', a 'Scope' dropdown menu with options 'Any', 'Action operation', 'Manual host action', and 'Manual event action', and buttons for 'Apply' and 'Reset'. A 'Filter' link with a funnel icon is visible in the top right corner.

Configuring a global script

The 'New script' form contains the following fields and options:

- Name:** Restart webserver
- Scope:** Action operation, Manual host action, Manual event action
- Menu path:** <sub-menu/sub-menu/...>
- Type:** URL, Webhook, Script, SSH, Telnet, IPMI
- Execute on:** Zabbix agent, Zabbix proxy or server, Zabbix server
- Commands:** sudo /etc/init.d/apache2 restart
- Description:** (empty text area)
- Host group:** All
- User group:** All
- Required host permissions:** Read, Write
- Advanced configuration:** (collapsed section)

Buttons for 'Add' and 'Cancel' are located at the bottom right of the form.

Script attributes:

Parameter	Description
<i>Name</i>	Unique name of the script. E.g. Clear /tmp filesystem

Parameter	Description
<i>Scope</i>	<p>Scope of the script - action operation, manual host action or manual event action. This setting determines where the script can be used - in remote commands of action operations, from the host menu or from the event menu respectively.</p> <p>Setting the scope to 'Action operation' makes the script available for all users with access to <i>Alerts</i> → <i>Actions</i>.</p> <p>If a script is actually used in an action, its scope cannot be changed away from 'action operation'.</p> <p>Macro support</p> <p>The scope affects the range of available macros. For example, user-related macros (<code>{USER.*}</code>) are supported in scripts to allow passing information about the user that launched the script. However, they are not supported if the script scope is action operation, as action operations are executed automatically.</p> <p>A <code>{MANUALINPUT}</code> macro allows to specify manual input at script execution time. It is supported for manual host action and manual event action scripts.</p> <p>To find out which other macros are supported, do a search for 'Trigger-based notifications and commands/Trigger-based commands', 'Manual host action scripts' and 'Manual event action scripts' in the supported macro table. Note that if a macro may resolve to a value with spaces (for example, host name), don't forget to quote as needed.</p>
<i>Menu path</i>	<p>The desired menu path to the script. For example, Default or Default/, will display the script in the respective directory. Menus can be nested, e.g. Main menu/Sub menu1/Sub menu2. When accessing scripts through the host/event menu in monitoring sections, they will be organized according to the given directories.</p> <p>This field is displayed only if 'Manual host action' or 'Manual event action' is selected as <i>Scope</i>.</p>
<i>Type</i>	<p>Click the respective button to select script type: URL, Webhook, Script, SSH, Telnet or IPMI command.</p> <p>The type URL is available only when 'Manual host action' or 'Manual event action' is selected as <i>Scope</i>.</p>
Script type: URL <i>URL</i>	<p>Specify the URL for quick access from the host menu or event menu. Macros and custom user macros are supported. Macro support depends on the scope of the script (see <i>Scope</i> above).</p> <p>Use the <code>{MANUALINPUT}</code> macro in this field to be able to specify manual input at script execution time, for example: <code>http://{MANUALINPUT}/zabbix/zabbix.php?action=dashboard.view</code></p> <p>Macro values must not be URL-encoded.</p>
<i>Open in new window</i>	Determines whether the URL should be opened in a new or the same browser tab.
Script type: Webhook <i>Parameters</i>	<p>Specify the webhook variables as attribute-value pairs. See also: Webhook media configuration.</p> <p>Macros and custom user macros are supported in parameter values. Macro support depends on the scope of the script (see <i>Scope</i> above).</p>
<i>Script</i>	<p>Enter the JavaScript code in the modal editor that opens when clicking in the parameter field or on the pencil icon next to it.</p> <p>Macro support depends on the scope of the script (see <i>Scope</i> above).</p> <p>See also: Webhook media configuration, Additional Javascript objects.</p>
<i>Timeout</i>	<p>JavaScript execution timeout (1-60s, default 30s). Time suffixes are supported, e.g. 30s, 1m.</p>
Script type: Script <i>Execute on</i>	<p>Click the respective button to execute the shell script on:</p> <p>Zabbix agent - the script will be executed by Zabbix agent (if the system.run item is allowed) on the host</p> <p>Zabbix proxy or server - the script will be executed by Zabbix proxy or server - depending on whether the host is monitored by proxy or server. It will be executed on the proxy if enabled by EnableRemoteCommands. It will be executed on the server if global scripts are enabled by the EnableGlobalScripts server parameter.</p> <p>Zabbix server - the script will be executed by Zabbix server only. This option will not be available if global scripts are disabled by the EnableGlobalScripts server parameter.</p>

Parameter	Description
<i>Commands</i>	Enter full path to the commands to be executed within the script. Macro support depends on the scope of the script (see <i>Scope</i> above). Custom user macros are supported.
Script type: SSH	
<i>Authentication method</i>	Select authentication method - password or public key.
<i>Username</i>	Enter the username.
<i>Password</i>	Enter the password. This field is available if 'Password' is selected as the authentication method.
<i>Public key file</i>	Enter the path to the public key file. This field is available if 'Public key' is selected as the authentication method.
<i>Private key file</i>	Enter the path to the private key file. This field is available if 'Public key' is selected as the authentication method.
<i>Passphrase</i>	Enter the passphrase. This field is available if 'Public key' is selected as the authentication method.
<i>Port</i>	Enter the port.
<i>Commands</i>	Enter the commands. Macro support depends on the scope of the script (see <i>Scope</i> above). Custom user macros are supported.
Script type: Telnet	
<i>Username</i>	Enter the username.
<i>Password</i>	Enter the password.
<i>Port</i>	Enter the port.
<i>Commands</i>	Enter the commands. Macro support depends on the scope of the script (see <i>Scope</i> above). Custom user macros are supported.
Script type: IPMI	
<i>Command</i>	Enter the IPMI command. Macro support depends on the scope of the script (see <i>Scope</i> above). Custom user macros are supported.
<i>Description</i>	Enter a description for the script.
<i>Host group</i>	Select the host group that the script will be available for (or <i>All</i> for all host groups).
<i>User group</i>	Select the user group that the script will be available to (or <i>All</i> for all user groups). This field is displayed only if 'Manual host action' or 'Manual event action' is selected as <i>Scope</i> .
<i>Required host permissions</i>	Select the permission level for the host group - <i>Read</i> or <i>Write</i> . Only users with the required permission level will have access to executing the script. This field is displayed only if 'Manual host action' or 'Manual event action' is selected as <i>Scope</i> .
<i>Advanced configuration</i>	Click on the <i>Advanced configuration</i> label to display advanced configuration options. This field is displayed only if 'Manual host action' or 'Manual event action' is selected as <i>Scope</i> .

Advanced configuration

Advanced configuration options are available in a collapsible *Advanced configuration* section:

Advanced configuration

Enable user input

* Input prompt

Input type String Dropdown

Default input string

* Input validation rule

Enable confirmation

* Confirmation text

Parameter	Description
<i>Enable user input</i>	Mark the checkbox to enable manual user input before executing the script. Manual user input will replace the {MANUALINPUT} macro value in the script. See also: Manual user input .
<i>Input prompt</i>	Enter custom text prompting for custom user input. This text will be displayed above the input field in the <i>Manual input</i> popup. To see a preview of the <i>Manual input</i> popup, click on <i>Test user input</i> . The preview also allows to test if the input string complies with the input validation rule (see parameters below). Macro and user macro support depends on the scope of the script (see <i>Scope</i> in general script configuration parameters).
<i>Input type</i>	Select the manual input type: String - single string; Dropdown - value is selected from multiple dropdown options.
<i>Dropdown options</i>	Enter unique values for the user input dropdown in a comma-delimited list. To include an empty option in the dropdown, add an extra comma at the beginning, middle, or end of the list. This field is displayed only if 'Dropdown' is selected as <i>Input type</i> .
<i>Default input string</i>	Enter the default string for user input (or none). This field will be validated against the regular expression provided in the <i>Input validation rule</i> field. The value entered here will be displayed by default in the <i>Manual input</i> popup.
<i>Input validation rule</i>	This field is displayed only if 'String' is selected as <i>Input type</i> . Enter a regular expression to validate the user input string. Global regular expressions are supported. This field is displayed only if 'String' is selected as <i>Input type</i> .
<i>Enable confirmation</i>	Mark the checkbox to display a confirmation message before executing the script. This feature might be especially useful with potentially dangerous operations (like a reboot script) or ones that might take a long time.
<i>Confirmation text</i>	Enter custom confirmation text for the confirmation popup enabled with the checkbox above (for example, <i>Remote system will be rebooted. Are you sure?</i>). To see how the text will look like, click on <i>Test confirmation</i> next to the field. Macros and custom user macros are supported. <i>Note:</i> the macros will not be expanded when testing the confirmation message.

If both manual user input and a confirmation message are configured, they will be displayed in consecutive popup windows.

Manual user input

Manual user input allows to supply a custom parameter on each execution of the script. This saves the necessity to create multiple similar user scripts with only a single parameter difference.

For example, you may want to supply a different integer or a different URL address to the script during execution.

To enable manual user input:

- use the {MANUALINPUT} macro in the script (commands, script, script parameter) where required; or in the URL field of URL scripts;
- in **advanced script configuration**, enable manual user input and configure input options.

With user input enabled, before script execution, a *Manual input* popup will appear to the user asking to supply a custom value. The supplied value will replace {MANUALINPUT} in the script.

Depending on the configuration, the user will be asked to enter a string value:

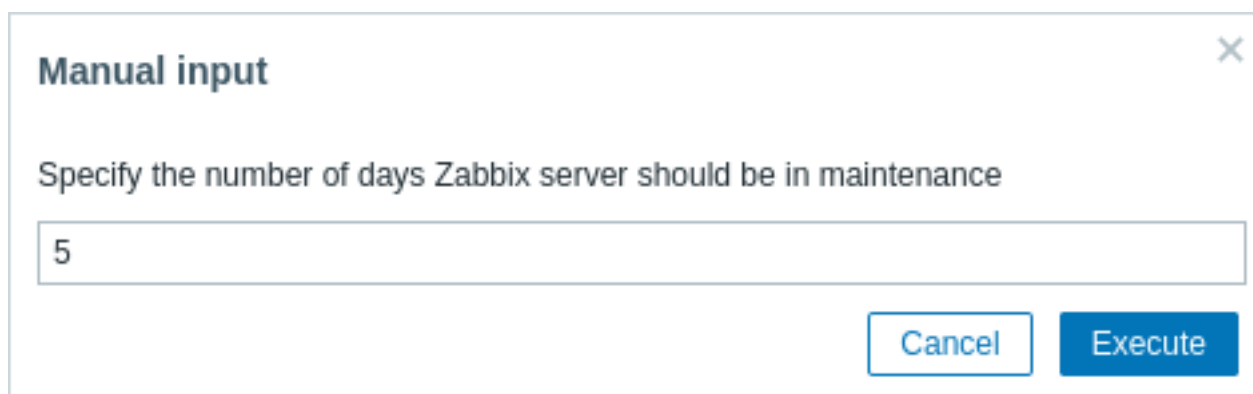

Or select the value from a dropdown of pre-determined options:

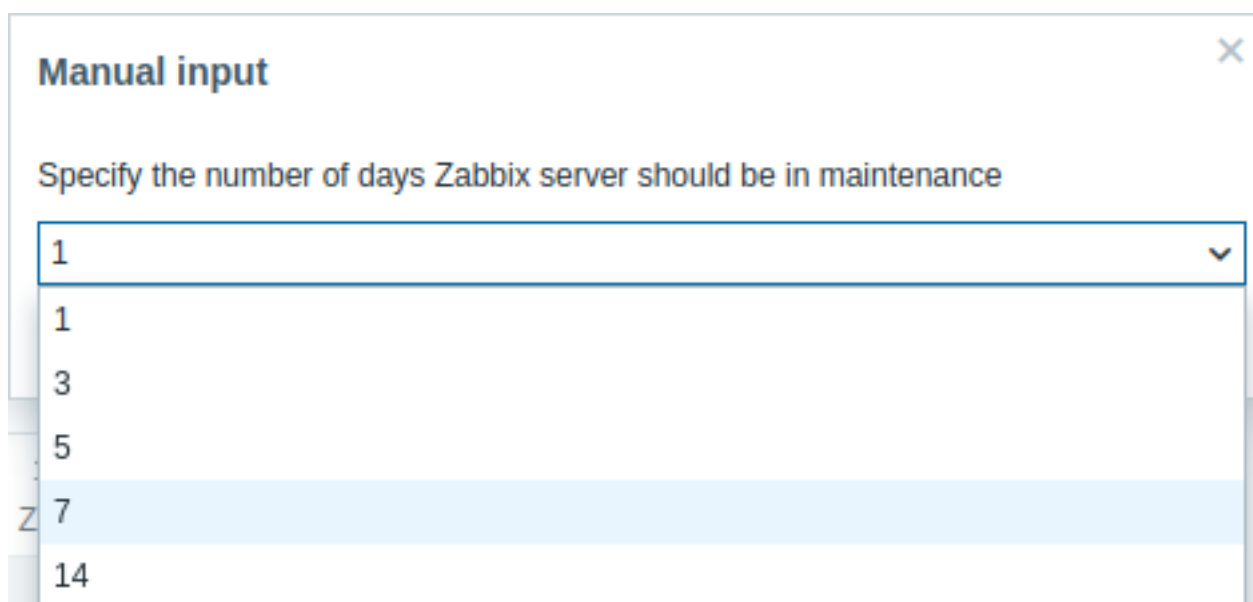

Manual user input is available only for scripts where the scope is 'Manual host action' or 'Manual event action'.

Script execution and result

Scripts run by Zabbix server are executed in the order described in the *Command execution* page (including exit code checking). The script result will be displayed in a pop-up window that will appear after the script is run.

The return value of the script is a standard output together with a standard error.

The return value is limited to 16MB (including trailing whitespace that is truncated); *database limits* also apply. When data has to pass through Zabbix proxy, it must be stored in the database, thus subjecting it to the same *database limits*.

See an example of a script and the result window below:

```
uname -v
/tmp/non_existing_script.sh
echo "This script was started by {USER.USERNAME}"
```

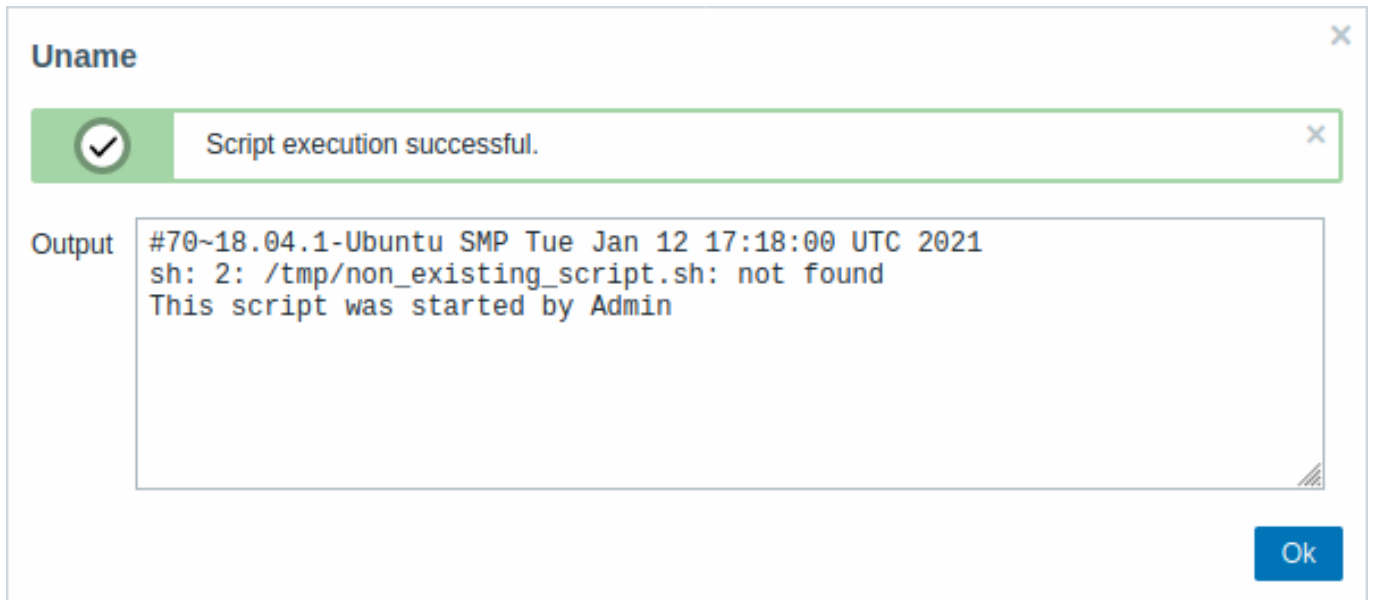

The script result does not display the script itself.

Script timeout

Zabbix agent

You may encounter a situation when a timeout occurs while executing a script.

See an example of a script running on Zabbix agent and the result window below:

```
sleep 5
df -h
```

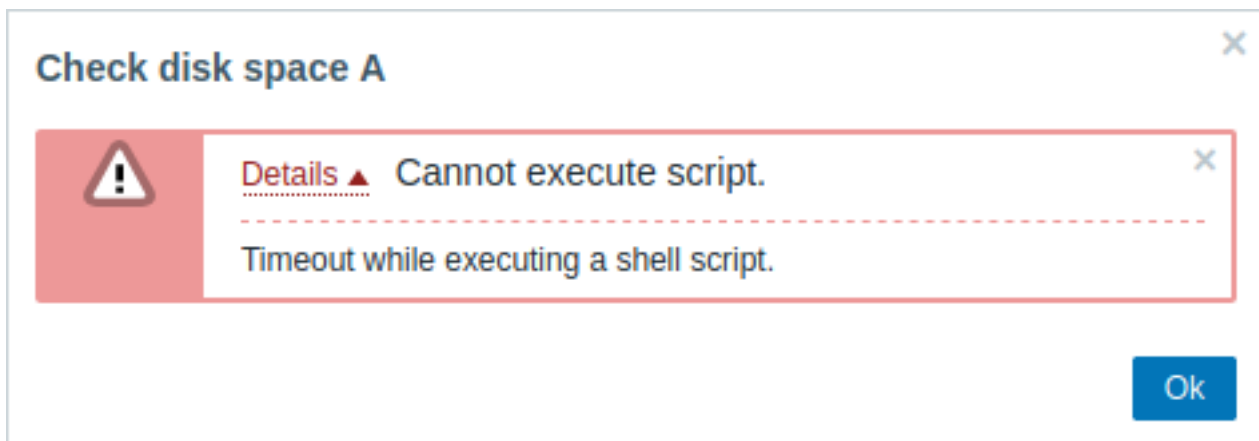

The error message, in this case, is the following:

Timeout while executing a shell script.

To avoid such situations, it is advised to optimize the script itself (in the example above, "5") instead of adjusting the Timeout parameter in [Zabbix agent configuration](#) and [Zabbix server configuration](#). However, for Zabbix agent in active mode, the Timeout parameter in [Zabbix server configuration](#) should be at least several seconds longer than the RefreshActiveChecks parameter in [Zabbix agent configuration](#). This ensures that the server has enough time to receive the active check results from the agent. Note that script execution on an active agent is supported since Zabbix agent 7.0.

In case the Timeout parameter has been changed in [Zabbix agent configuration](#), the following error message will appear:

```
Get value from agent failed: ZBX_TCP_READ() timed out.
```

It means that the modification has been made in [Zabbix agent configuration](#), but it is required to modify the Timeout parameter in [Zabbix server configuration](#) as well.

Zabbix server/proxy

See an example of a script running on Zabbix server and the result window below:

```
sleep 11
df -h
```

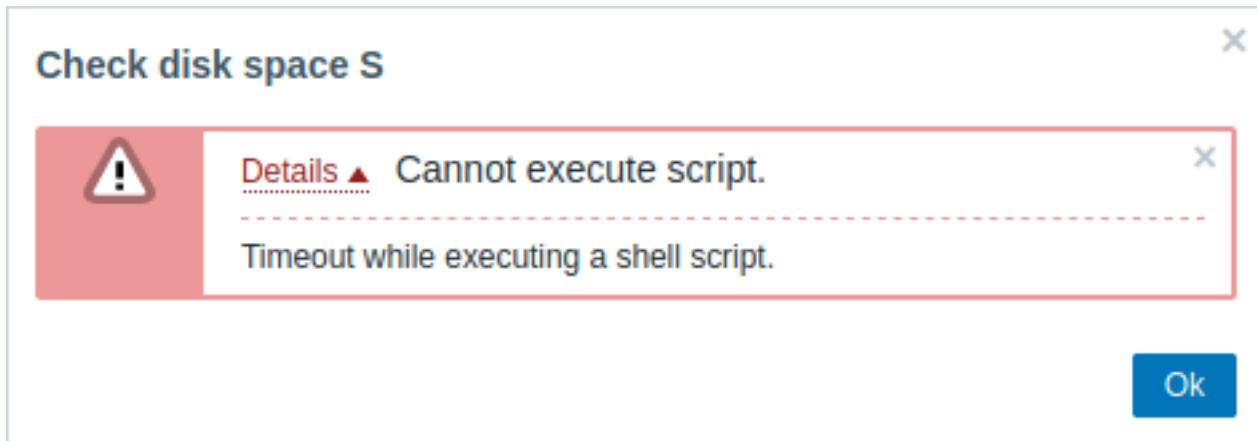

It is also advised to optimize the script itself (instead of adjusting `TrapperTimeout` parameter to a corresponding value (in our case, > '11') by modifying the [Zabbix server configuration](#)).

8 Users

Overview

This menu features sections that are related to configuring users in Zabbix. This menu is available to **SuperAdmin** user type users only.

1 User groups

Overview

In the *Users* → *User groups* section user groups of the system are maintained.

User groups

A listing of existing user groups with their details is displayed.

☰ User groups ? Create user group

<input type="checkbox"/> Name ▲	#	Members	Frontend access	Debug mode	Status
<input type="checkbox"/> Disabled	Users 1	guest	System default	Disabled	Disabled
<input type="checkbox"/> Enabled debug mode	Users		System default	Enabled	Enabled
<input type="checkbox"/> Guests	Users 1	guest	Internal	Disabled	Enabled
<input type="checkbox"/> No access to the frontend	Users		Disabled	Disabled	Enabled
<input type="checkbox"/> Zabbix administrators	Users 1	Admin (Zabbix Administrator)	System default	Disabled	Enabled

Displaying 5 of 5 found

0 selected

Displayed data:

Column	Description
<i>Name</i>	Name of the user group. Clicking on the user group name opens the user group configuration form .
<i>#</i>	The number of users in the group. Clicking on <i>Users</i> will display the respective users filtered out in the user list.
<i>Members</i>	Usernames of individual users in the user group (with name and surname in parentheses). Clicking on the username will open the user configuration form. Users from disabled groups are displayed in red.
<i>Frontend access</i>	Frontend access level is displayed: System default - users are authenticated by Zabbix, LDAP or HTTP (depending on the authentication method set globally); Internal - users are authenticated by Zabbix; ignored if HTTP authentication is the global default; LDAP - users are authenticated by LDAP; ignored if HTTP authentication is the global default; Disabled - access to Zabbix frontend is forbidden for this group. By clicking on the current level, you can change it.

Column	Description
<i>Debug mode</i>	Debug mode status is displayed - <i>Enabled</i> or <i>Disabled</i> . By clicking on the status you can change it.
<i>Status</i>	User group status is displayed - <i>Enabled</i> or <i>Disabled</i> . By clicking on the status you can change it.

To configure a new user group, click on the *Create user group* button in the top right-hand corner.

Mass editing options

Buttons below the list offer some mass-editing options:

- *Enable* - change the user group status to *Enabled*
- *Disable* - change the user group status to *Disabled*
- *Enable debug mode* - enable debug mode for the user groups
- *Disable debug mode* - disable debug mode for the user groups
- *Delete* - delete the user groups

To use these options, mark the checkboxes before the respective user groups, then click on the required button.

Using filter

You can use the filter to display only the user groups you are interested in. For better search performance, data is searched with macros unresolved.

The *Filter* link is available above the list of user groups. If you click on it, a filter becomes available where you can filter user groups by name and status.

2 User roles

Overview

In the *Users* → *User roles* section you may create user roles.

User roles allow to create fine-grained permissions based on the initially selected user type (*User*, *Admin*, *Super admin*).

Upon selecting a user type, all available permissions for this user type are granted (checked by default).

Permissions can only be revoked from the subset that is available for the user type; they cannot be extended beyond what is available for the user type.

Checkboxes for unavailable permissions are grayed out; users will not be able to access the element even by entering a direct URL to this element into the browser.

User roles can be assigned to system users. Each user may have only one role assigned.

Default user roles

By default, Zabbix is configured with four user roles, which have a pre-defined set of permissions:

- Guest role
- User role
- Admin role
- Super admin role

These are based on the main user types in Zabbix. The list of all users assigned the respective role is displayed. The users included in disabled groups are stated in red. The *Guest role* is a user-type role with the only permissions to view some frontend sections.

Note:

The default *Super admin role* cannot be modified or deleted, because at least one Super admin user with unlimited privileges must exist in Zabbix. Users of type *Super admin* can modify settings of their own role, but not the user type.

Configuration

To create a new role, click on the *Create user role* button at the top right corner. To update an existing role, click on the role name to open the configuration form.

* Name

User type

Access to UI elements

- Dashboards
- Monitoring Problems Latest data Discovery
 Hosts Maps
- Services Services SLA SLA report
- Inventory Overview Hosts
- Reports System information Top 100 triggers Notifications
 Scheduled reports Audit log
 Availability report Action log
- Data collection Template groups Hosts Discovery
 Host groups Maintenance
 Templates Event correlation
- Alerts Trigger actions Autoregistration actions Scripts
 Service actions Internal actions
 Discovery actions Media types
- Users User groups Users Authentication
 User roles API tokens
- Administration General Proxy groups Queue
 Audit log Proxies
 Housekeeping Macros

* At least one UI element must be checked.

Default access to new UI elements

Access to services

Read-write access to services

Read-only access to services

Access to modules

- Action log
- Clock
- Discovery status
- Favorite graphs
- Favorite maps
- Gauge
- Geomap
- Graph
- Graph (classic)
- Graph prototype
- Honeycomb
- Host availability
- Host card
- Host navigator
- Item history
- Item navigator
- Item value
- Map
- Map navigation tree
- Pie chart
- Problem hosts
- Problems
- Problems by severity
- SLA report
- System information
- Top hosts
- Top items
- Top triggers
- Trigger overview
- URL
- Web monitoring

Default access to new modules

Access to API

Enabled

API methods

Access to actions

- Create and edit dashboards
- Create and edit maps
- Create and edit maintenance
- Add problem comments
- Change severity
- Acknowledge problems
- Suppress problems
- Close problems
- Execute scripts
- Manage API tokens
- Manage scheduled reports
- Manage SLA
- Invoke "Execute now" on read-only hosts
- Change problem ranking

Default access to new actions

Available permissions are displayed. To revoke a certain permission, unmark its checkbox.

Available permissions along with the defaults for each pre-configured user role in Zabbix are described below.

Default permissions

Access to UI elements

The default access to menu sections depends on the user type. See the Permissions page for [details](#).

Access to other options

Parameter	Description	Default user roles			
		Super admin role	Admin role	User role	Guest role
Default access to new UI elements	Enable/disable access to the custom UI elements. Modules, if present, will be listed below.	Yes	Yes	Yes	Yes
Access to services					
Read-write access to services	Select read-write access to services: None - no access at all All - access to all services is read-write Service list - select services for read-write access	All	All	None	None
Read-write access to services with tag	The read-write access, if granted, takes precedence over the read-only access settings and is dynamically inherited by the child services. Specify tag name and, optionally, value to additionally grant read-write access to services matching the tag. This option is available if 'Service list' is selected in the <i>Read-write access to services</i> parameter. The read-write access, if granted, takes precedence over the read-only access settings and is dynamically inherited by the child services.				
Read-only access to services	Select read-only access to services: None - no access at all All - access to all services is read-only Service list - select services for read-only access			All	All
Read-only access to services with tag	The read-only access does not take precedence over the read-write access and is dynamically inherited by the child services. Specify tag name and, optionally, value to additionally grant read-only access to services matching the tag. This option is available if 'Service list' is selected in the <i>Read-only access to services</i> parameter. The read-only access does not take precedence over the read-write access and is dynamically inherited by the child services.				
Access to modules					

<Module name>	Allow/deny access to a specific module. Only enabled modules are shown in this section. It is not possible to grant or restrict access to a module that is currently disabled.	Yes	Yes	Yes	Yes
<i>Default access to new modules</i>	Enable/disable access to modules that may be added in the future.				
Access to API					
<i>Enabled API methods</i>	Enable/disable access to API. Select either <i>Allow list</i> to allow, or <i>Deny list</i> to deny the API methods specified in the search field. Note that it is not possible to allow some API methods and deny others.	Yes	Yes	Yes	No
	In the search field, start typing the method name, then select the method from the auto-complete list. You can also press the Select button and select methods from the full list available for this user type. Note that if certain action from the Access to actions block is unchecked, users will not be able to use API methods related to this action.				
	Wildcards are supported. Examples: <code>dashboard.*</code> (all methods of 'dashboard.' API service) <code>* (any method)</code> , <code>*.export</code> (methods with '.export' name from all API services).				
	If no methods have been specified the <i>Allow/Deny list</i> rule will be ignored.				
Access to actions					
Create and edit dashboards	Clearing this checkbox will also revoke the rights to use <code>.create</code> , <code>.update</code> and <code>.delete</code> API methods for the corresponding elements.	Yes	Yes	Yes	No
Create and edit maps					
Create and edit maintenance					No
Add problem comments	Clearing this checkbox will also revoke the rights to perform corresponding action via event <code>.acknowledge</code> API method.				Yes
Change severity					
Acknowledge problems					
Suppress problems					
Close problems					
Execute scripts	Clearing this checkbox will also revoke the rights to use the <code>script.execute</code> API method.				
Manage API tokens	Clearing this checkbox will also revoke the rights to use all <code>token.</code> API methods.				
Manage scheduled reports	Clearing this checkbox will also revoke the rights to use all <code>report.</code> API methods.				No
Manage SLA	Enable/disable the rights to manage SLA .				
Invoke "Execute now" on read-only hosts	Allow to use the "Execute now" option in latest data for items of read-only hosts.				Yes
Change problem ranking	Allow to change the problem ranking from cause to symptom, and vice versa.				

Default access to new actions Enable/disable access to new actions.

See also:

- [Configuring a user](#)

3 Users

Overview

In the *Users* → *Users* section users of the system are maintained.

Users

A listing of existing users with their details is displayed.

<input type="checkbox"/>	Username ▲	Name	Last name	User role	Groups	Is online?	Login	Frontend access	API access	Debug mode	Status	Provisioned	Info
<input type="checkbox"/>	Admin	Zabbix	Administrator	Super admin role	Zabbix administrators	Yes (2022-12-06 16:12:32)	Ok	System default	Enabled	Disabled	Enabled		
<input type="checkbox"/>	guest			Guest role	Disabled, Guests	No	Ok	Internal	Disabled	Disabled	Disabled		

0 selected Provision now Reset TOTP secret Unblock Delete

Displayed data:

Column	Description
<i>Username</i>	Username for logging into Zabbix. Clicking on the username opens the user configuration form .
<i>Name</i>	First name of the user.
<i>Last name</i>	Second name of the user.
<i>User role</i>	User role is displayed.
<i>Groups</i>	Groups that the user is a member of are listed. Clicking on the user group name opens the user group configuration form. Disabled groups are displayed in red.
<i>Is online?</i>	The on-line status of the user is displayed - <i>Yes</i> or <i>No</i> . The time of last user activity is displayed in parentheses.
<i>Login</i>	The login status of the user is displayed - <i>Ok</i> or <i>Blocked</i> . A user can become temporarily blocked upon exceeding the number of unsuccessful login attempts set in the Administration → General → Other section (five by default). By clicking on <i>Blocked</i> you can unblock the user.
<i>Frontend access</i>	Frontend access level is displayed - <i>System default</i> , <i>Internal</i> , <i>LDAP</i> , or <i>Disabled</i> , depending on the one set for the whole user group.
<i>API access</i>	API access status is displayed - <i>Enabled</i> or <i>Disabled</i> , depending on the one set for the user role.
<i>Debug mode</i>	Debug mode status is displayed - <i>Enabled</i> or <i>Disabled</i> , depending on the one set for the whole user group.
<i>Status</i>	User status is displayed - <i>Enabled</i> or <i>Disabled</i> , depending on the one set for the whole user group.
<i>Provisioned</i>	The date when the user was last provisioned is displayed.
<i>Info</i>	Used for users created by JIT provisioning from LDAP/SAML. Information about errors is displayed. A yellow warning is displayed for users without user groups. A red warning is displayed for users without roles, and for users without roles and user groups.

To configure a new user, click on the *Create user* button in the top right-hand corner.

Mass editing options

Buttons below the list offer some mass-editing options:

- *Provision now* - update user information from LDAP (this option is only enabled if an **LDAP** user is selected)
- *Reset TOTP secret* - reset user TOTP secrets for all TOTP methods and delete the user session (this option is only enabled if **MFA** is enabled; for users without TOTP secrets, their session will not be deleted)
- *Unblock* - re-enable system access to blocked users
- *Delete* - delete the users

To use these options, mark the check-boxes before the respective users, then click on the required button.

Using filter

You can use the filter to display only the users you are interested in. For better search performance, data is searched with macros unresolved.

The *Filter* link is available above the list of users. If you click on it, a filter becomes available where you can filter users by username, name, last name, user role and user group.

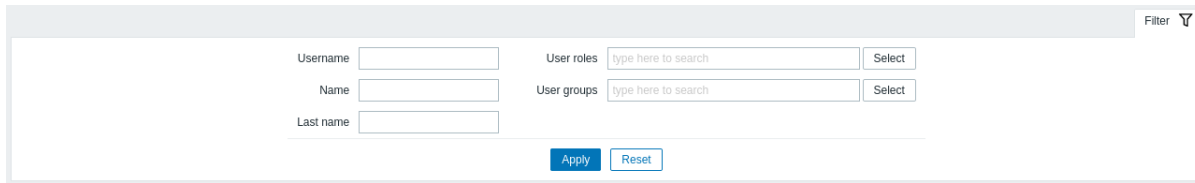

A filter dialog box with a title bar containing a 'Filter' label and a dropdown arrow. The dialog contains several input fields: 'Username', 'Name', and 'Last name' on the left; 'User roles' and 'User groups' on the right, each with a 'Select' button. At the bottom, there are 'Apply' and 'Reset' buttons.

4 API tokens

Overview

This section allows to create and manage API tokens.

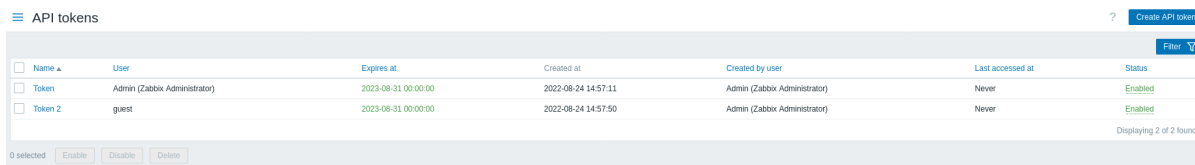

A table titled 'API tokens' with a 'Create API token' button at the top right. The table has columns: Name, User, Expires at, Created at, Created by user, Last accessed at, and Status. It lists two tokens: 'Token' assigned to 'Admin (Zabbix Administrator)' and 'Token 2' assigned to 'guest'. Below the table are buttons for '0 selected', 'Enable', 'Disable', and 'Delete'.

Name	User	Expires at	Created at	Created by user	Last accessed at	Status
Token	Admin (Zabbix Administrator)	2023-08-31 00:00:00	2022-08-24 14:57:11	Admin (Zabbix Administrator)	Never	Enabled
Token 2	guest	2023-08-31 00:00:00	2022-08-24 14:57:50	Admin (Zabbix Administrator)	Never	Enabled

You may filter API tokens by name, users to whom the tokens are assigned, expiry date, users that created tokens, or status (enabled/disabled). Click on the token status in the list to quickly enable/disable a token. You may also mass enable/disable tokens by selecting them in the list and then clicking on the *Enable/Disable* buttons below the list.

To create a new token, press *Create API token* button at the top right corner, then fill out the required fields in the token configuration screen:

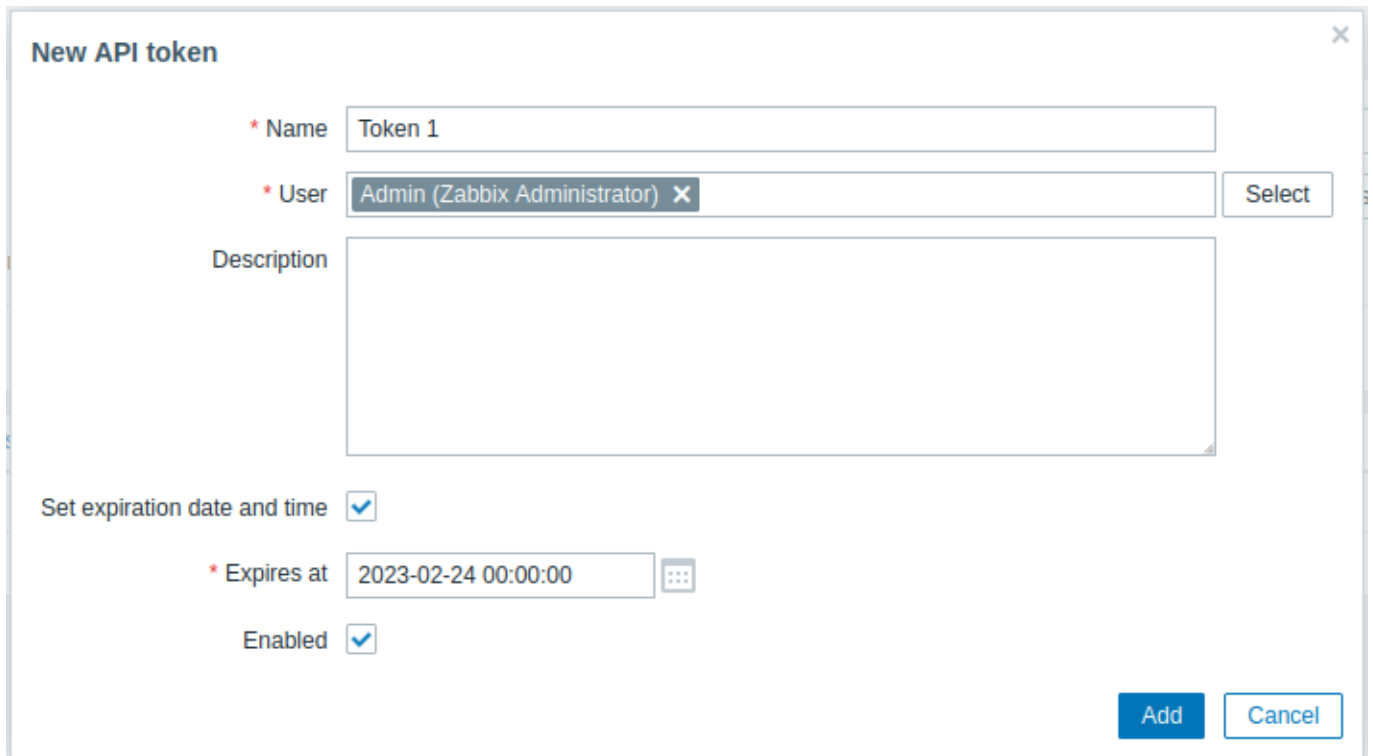

A 'New API token' configuration form. It includes fields for 'Name' (Token 1), 'User' (Admin (Zabbix Administrator) with a 'Select' button), and a 'Description' text area. There are checkboxes for 'Set expiration date and time' and 'Enabled'. The 'Expires at' field is set to '2023-02-24 00:00:00'. At the bottom right are 'Add' and 'Cancel' buttons.

Parameter	Description
Name	Token's visible name.
User	User the token should be assigned to. To quickly select a user, start typing the username, first or last name, then select the required user from the auto-complete list. Alternatively, you can press the <i>Select</i> button and select a user from the full user list. A token can be assigned only to one user.

Parameter	Description
Description	Optional token description.
Set expiration date and time	Unmark this checkbox if a token should not have an expiry date.
Expiry date	Click on the calendar icon to select token expiry date or enter the date manually in a format YYYY-MM-DD hh:mm:ss
Enabled	Unmark this checkbox if you need to create a token in a disabled state.

Press Add to create a token. On the next screen, copy and save in a safe place *Auth token* value **before closing the page**, then press Close. The token will appear in the list.

Warning:

Auth token value cannot be viewed again later. It is only available immediately after creating a token. If you lose a saved token you will have to regenerate it and doing so will create a new authorization string.

Click on the token name to edit the name, description, expiry date settings, or token status. Note that it is not possible to change to which user the token is assigned. Press *Update* button to save changes. If a token has been lost or exposed, you may press *Regenerate* button to generate new token value. A confirmation dialog box will appear, asking you to confirm this operation since after proceeding the previously generated token will become invalid.

Users without access to the *Administration* menu section can see and modify details of tokens assigned to them in the *User profile* → *API tokens* section only if *Manage API tokens* is allowed in their *user role* permissions.

5 Authentication

Overview

The *Users* → *Authentication* section allows to specify the user authentication method for Zabbix and internal password requirements.

The available authentication methods are internal, HTTP, LDAP, SAML, and MFA authentication.

Default authentication

By default, Zabbix uses **internal** Zabbix authentication for all users.

It is possible to change the default authentication method to **LDAP** system-wide. To do so, navigate to the *LDAP* tab and configure LDAP parameters, then return to the *Authentication* tab and switch the *Default authentication* selector to LDAP.

Note that the authentication method can be fine-tuned on the *user group* level. Even if LDAP authentication is set globally, some user groups can still be authenticated by Zabbix. These groups must have **frontend access** set to Internal.

It is also possible to enable LDAP authentication only for specific user groups, if internal authentication is used globally. In this case LDAP authentication details can be specified and used for specific user groups whose **frontend access** must then be set to LDAP. If a user is included into at least one user group with LDAP authentication, this user will not be able to use the internal authentication method.

HTTP, SAML 2.0, and MFA authentication methods can be used in addition to the default authentication method.

Zabbix supports just-in-time (JIT) provisioning that allows to create user accounts in Zabbix the first time an external user authenticates and provision these user accounts. JIT provisioning is supported for LDAP and SAML.

See also:

- [HTTP authentication](#)
- [LDAP authentication](#)
- [SAML authentication](#)
- [MFA authentication](#)

Configuration

The *Authentication* tab allows to set the default authentication method, specify a group for deprovisioned users and set password complexity requirements for Zabbix users.

Authentication **HTTP settings** LDAP settings SAML settings MFA settings

Default authentication Internal LDAP

Deprovisioned users group

Password policy

Minimum password length

Password must contain an uppercase and a lowercase Latin letter
 a digit
 a special character

Avoid easy-to-guess passwords

Configuration parameters:

Parameter	Description
<i>Default authentication</i>	Select the default authentication method for Zabbix - <i>Internal</i> or <i>LDAP</i> .
<i>Deprovisioned users group</i>	Specify a user group for deprovisioned users. This setting is required only for JIT provisioning, regarding users that were created in Zabbix from LDAP or SAML systems, but no longer need to be provisioned. A disabled user group must be specified.
<i>Minimum password length</i>	By default, the minimum password length is set to 8. Supported range: 1-70. Note that passwords longer than 72 characters will be truncated.
<i>Password must contain</i>	Mark one or several checkboxes to require usage of specified characters in a password: - an uppercase and a lowercase Latin letter - a digit - a special character
<i>Avoid easy-to-guess passwords</i>	Hover over the question mark to see a hint with the list of characters for each option. If marked, a password will be checked against the following requirements: - must not contain user's name, surname, or username - must not be one of the common or context-specific passwords. The list of common and context-specific passwords is generated automatically from the list of NCSC "Top 100k passwords", the list of SecLists "Top 1M passwords" and the list of Zabbix context-specific passwords. Internal users will not be allowed to set passwords included in this list as such passwords are considered weak due to their common use.

Changes in password complexity requirements will not affect existing user passwords, but if an existing user chooses to change a password, the new password will have to meet current requirements. A hint with the list of requirements will be displayed next to the *Password* field in the [user profile](#) and in the [user configuration form](#) accessible from the *Users* → *Users* menu.

1 HTTP

Overview

HTTP or web server-based [authentication](#) (for example: BasicAuthentication, NTLM/Kerberos) can be used to check user names and passwords. Note that a user must exist in Zabbix as well, however its Zabbix password will not be used.

Attention:

Be careful! Make sure that web server authentication is configured and works properly before switching it on.

HTTP authentication can be disabled in the frontend configuration file by setting `$ALLOW_HTTP_AUTH=false` in `zabbix.conf.php`. In this case the tab with HTTP authentication options will not be displayed in the frontend. Note that reinstalling the frontend (running `setup.php`) will remove this parameter.

Configuration

Authentication HTTP settings ● LDAP settings SAML settings MFA settings

Enable HTTP authentication ?

Default login form

Remove domain name

Case-sensitive login

Configuration parameters:

Parameter	Description
<i>Enable HTTP authentication</i>	Mark the checkbox to enable HTTP authentication. Hovering the mouse over ? will bring up a hint box warning that in the case of web server authentication, all users (even with frontend access set to LDAP/Internal) will be authenticated by the web server, not by Zabbix.
<i>Default login form</i>	Specify whether to direct non-authenticated users to: Zabbix login form - standard Zabbix login page. HTTP login form - HTTP login page. It is recommended to enable web-server based authentication for the <code>index_http.php</code> page only. If <i>Default login form</i> is set to 'HTTP login page' the user will be logged in automatically if web server authentication module will set valid user login in the <code>\$_SERVER</code> variable. Supported <code>\$_SERVER</code> keys are <code>PHP_AUTH_USER</code> , <code>REMOTE_USER</code> , <code>AUTH_USER</code> .
<i>Remove domain name</i>	A comma-delimited list of domain names that should be removed from the username. E.g. <code>comp,any</code> - if username is 'Admin@any', 'comp\Admin', user will be logged in as 'Admin'; if username is 'notacompany\Admin', login will be denied.
<i>Case sensitive login</i>	Unmark the checkbox to disable case-sensitive login (enabled by default) for usernames. E.g. disable case-sensitive login and log in with, for example, 'ADMIN' user even if the Zabbix user is 'Admin'. <i>Note that with case-sensitive login disabled the login will be denied if multiple users exist in Zabbix database with similar usernames (e.g. Admin, admin).</i>

Note:

For internal users who are unable to log in using HTTP credentials (with HTTP login form set as default) leading to the 401 error, you may want to add a `ErrorDocument 401 /index.php?form=default` line to basic authentication directives, which will redirect to the regular Zabbix login form.

2 LDAP

Overview

External LDAP **authentication** can be used to check user names and passwords.

Zabbix LDAP authentication works at least with Microsoft Active Directory and OpenLDAP.

If only LDAP sign-in is configured, then the user must also exist in Zabbix, however, its Zabbix password will not be used. If authentication is successful, then Zabbix will match a local username with the username attribute returned by LDAP.

User provisioning

It is possible to configure JIT (just-in-time) **user provisioning** for LDAP users. In this case, it is not required that a user already exists in Zabbix. The user account can be created when the user logs into Zabbix for the first time.

When an LDAP user enters their LDAP login and password, Zabbix checks the *default* LDAP server if this user exists. If the user exists and does not have an account in Zabbix yet, a new user is created in Zabbix and the user is able to log in.

Attention:

If JIT provisioning is enabled, a user group for deprovisioned users must be specified in the *Authentication* tab.

JIT provisioning also allows to update provisioned user accounts based on changes in LDAP. For example, if a user is moved from one LDAP group to another, the user will also be moved from one group to another in Zabbix; if a user is removed from an LDAP group, the user will also be removed from the group in Zabbix and, if not belonging to any other group, added to the user group for deprovisioned users. Note that provisioned user accounts are updated based on the configured **provisioning period** or when the user logs into Zabbix.

LDAP JIT provisioning is available only when LDAP is configured to use "anonymous" or "special user" for binding. For direct user binding, provisioning will be made only for user login action, because logging in user password is used for such type of binding.

Multiple servers

Several LDAP servers can be defined, if necessary. For example, a different server can be used to authenticate a different user group. Once LDAP servers are configured, in **user group** configuration it becomes possible to select the required LDAP server for the respective user group.

If a user is in multiple user groups and multiple LDAP servers, the first server in the list of LDAP servers sorted by name in ascending order will be used for authentication.

Configuration

Configuration parameters:

Parameter	Description
<i>Enable LDAP authentication</i>	Mark the checkbox to enable LDAP authentication.
<i>Enable JIT provisioning</i>	Mark the checkbox to enable JIT provisioning.
<i>Servers</i>	Click on <i>Add</i> to configure an LDAP server (see LDAP server configuration below).
<i>Case-sensitive login</i>	Unmark the checkbox to disable case-sensitive login (enabled by default) for usernames. E.g. disable case-sensitive login and log in with, for example, 'ADMIN' user even if the Zabbix user is 'Admin'. <i>Note that with case-sensitive login disabled the login will be denied if multiple users exist in Zabbix database with similar usernames (e.g. Admin, admin).</i>
<i>Provisioning period</i>	Set the provisioning period, i.e. how often user provisioning is performed.

LDAP server configuration

New LDAP server ✕

* Name

* Host

* Port

* Base DN

* Search attribute

Bind DN

Bind password

Description

Configure JIT provisioning

Group configuration ? memberOf groupOfNames

Group name attribute

User group membership attribute

User name attribute

User last name attribute

* User group mapping

LDAP group pattern	User groups	User role	Action
zabbix-admin	Zabbix administrators	Super admin role	Remove
zabbix-user	Zabbix users	User role	Remove
Add			

Media type mapping ?

Name	Media type	Attribute	Action
Add			

^ Advanced configuration

StartTLS

Search filter

Add
Test
Cancel

LDAP server configuration parameters:

Parameter	Description
<i>Name</i>	Name of the LDAP server in Zabbix configuration.

Parameter	Description
<i>Host</i>	<p>Hostname, IP or URI of the LDAP server. Examples: ldap.example.com, 127.0.0.1, ldap://ldap.example.com</p> <p>For secure LDAP server, use <i>ldaps</i> protocol and hostname. Example: ldaps://ldap.example.com</p> <p>With OpenLDAP 2.x.x and later, a full LDAP URI of the form ldap://hostname:port or ldaps://hostname:port may be used.</p>
<i>Port</i>	<p>Port of the LDAP server. Default is 389.</p> <p>For secure LDAP connection port number is normally 636.</p> <p>Not used when using full LDAP URIs.</p>
<i>Base DN</i>	<p>Base path to user accounts in LDAP server:</p> <p>ou=Users,ou=system (for OpenLDAP), DC=company,DC=com (for Microsoft Active Directory) uid=%{user},dc=example,dc=com (for direct user binding, see a note below)</p>
<i>Search attribute</i>	<p>LDAP account attribute used for search:</p> <p>uid (for OpenLDAP), sAMAccountName (for Microsoft Active Directory)</p>
<i>Bind DN</i>	<p>LDAP account for binding and searching over the LDAP server, examples:</p> <p>uid=ldap_search,ou=system (for OpenLDAP), CN=ldap_search,OU=user_group,DC=company,DC=com (for Microsoft Active Directory)</p> <p>Anonymous binding is also supported. Note that anonymous binding potentially opens up domain configuration to unauthorized users (information about users, computers, servers, groups, services, etc.). For security reasons, disable anonymous binds on LDAP hosts and use authenticated access instead.</p>
<i>Bind password</i>	LDAP password of the account for binding and searching over the LDAP server.
<i>Description</i>	Description of the LDAP server.
<i>Configure JIT provisioning</i>	Mark this checkbox to show options related to JIT provisioning.
<i>Group configuration</i>	<p>Select the group configuration method:</p> <p>memberOf - by searching users and their group membership attribute groupOfNames - by searching groups through the member attribute</p> <p>Note that memberOf is preferable as it is faster; use groupOfNames if your LDAP server does not support memberOf or group filtering is required.</p>
<i>Group name attribute</i>	<p>Specify the attribute to get the group name from all objects in the memberOf attribute (see the <i>User group membership attribute</i> field)</p> <p>The group name is necessary for user group mapping.</p>
<i>User group membership attribute</i>	<p>Specify the attribute that contains information about the groups that the user belongs to (e.g. memberOf).</p> <p>For example, the memberOf attribute may hold information like this: memberOf=cn=zabbix-admin,ou=Groups,dc=example,dc=com</p> <p>This field is available only for the memberOf method.</p>
<i>User name attribute</i>	Specify the attribute that contains the user's first name.
<i>User last name attribute</i>	Specify the attribute that contains the user's last name.
<i>User group mapping</i>	<p>Map an LDAP user group pattern to Zabbix user group and user role.</p> <p>This is required to determine what user group/role the provisioned user will get in Zabbix.</p> <p>Click on <i>Add</i> to add a mapping.</p> <p>The <i>LDAP group pattern</i> field supports wildcards. The group name must match an existing group. If an LDAP user matches several Zabbix user groups, the user becomes a member of all of them. If a user matches several Zabbix user roles, the user will get the one with the highest permission level among them.</p>
<i>Media type mapping</i>	Map the user's LDAP media attributes (e.g. email) to Zabbix user media for sending notifications.
<i>Advanced configuration</i>	Click on the <i>Advanced configuration</i> label to display advanced configuration options (see below).
<i>StartTLS</i>	<p>Mark the checkbox to use the StartTLS operation when connecting to LDAP server. The connection will fail if the server doesn't support StartTLS.</p> <p>StartTLS cannot be used with servers that use the <i>ldaps</i> protocol.</p>
<i>Search filter</i>	<p>Define a custom string when authenticating a user in LDAP. The following placeholders are supported:</p> <p>%{attr} - search attribute name (uid, sAMAccountName) %{user} - user username value to authenticate</p> <p>For example, to carry out a case-sensitive search within the case-insensitive LDAP or Microsoft Active Directory environment, the string can be defined as follows: (%{attr}:caseExactMatch=%{user}).</p> <p>If the filter is not customized, LDAP will use the default: (%{attr}=%{user}).</p>

Note:

To configure an LDAP server for **direct user binding**, append an attribute `uid=%{user}` to the *Base DN* parameter (for example, `uid=%{user},dc=example,dc=com`) and leave *BindDN* and *Bind password* parameters empty. When authenticating, a placeholder `%{user}` will be replaced by the username entered during login.

The following fields are specific to "groupOfNames" as the *Group configuration* method:

Group configuration ?	memberOf groupOfNames
Group base DN	ou=Groups,dc=example,dc=com
Group name attribute	cn
Group member attribute	member
Reference attribute ?	uid
Group filter	(member=uid=%{ref},ou=Users,dc=example,dc=com)

Parameter	Description
<i>Group base DN</i>	Base path to the groups in LDAP server.
<i>Group name attribute</i>	Specify the attribute to get the group name in the specified base path to groups. The group name is necessary for user group mapping.
<i>Group member attribute</i>	Specify the attribute that contains information about the members of the group in LDAP (e.g. <code>member</code>).
<i>Reference attribute</i>	Specify the reference attribute for the group filter (see the <i>Group filter</i> field). Then use <code>%{ref}</code> in the group filter to get values for the attribute specified here.
<i>Group filter</i>	Specify the filter to retrieve the group that the user is member of. For example, <code>(member=uid=%{ref},ou=Users,dc=example,dc=com)</code> will match "User1" if the member attribute of the group is <code>uid=User1,ou=Users,dc=example,dc=com</code> and will return the group that "User1" is a member of.

Warning:

In case of trouble with certificates, to make a secure LDAP connection (ldaps) work you may need to add a `TLS_REQCERT allow` line to the `/etc/openldap/ldap.conf` configuration file. It may decrease the security of connection to the LDAP catalog.

Note:

It is recommended to create a separate LDAP account (*Bind DN*) to perform binding and searching over the LDAP server with minimal privileges in the LDAP instead of using real user accounts (used for logging in the Zabbix frontend). Such an approach provides more security and does not require changing the *Bind password* when the user changes his own password in the LDAP server. In the table above it's the *ldap_search* account name.

Testing access

The *Test* button allows to test user access:

Parameter	Description
<i>Login</i>	LDAP user name to test (prefilled with the current user name from Zabbix frontend). This user name must exist in the LDAP server.
<i>User password</i>	Zabbix will not activate LDAP authentication if it is unable to authenticate the test user. LDAP user password to test.

Overview

SAML 2.0 **authentication** can be used to sign in to Zabbix.

If only SAML sign-in is configured, then the user must also exist in Zabbix, however, its Zabbix password will not be used. If authentication is successful, then Zabbix will match a local username with the username attribute returned by SAML.

User provisioning

It is possible to configure JIT (just-in-time) **user provisioning** for SAML users. In this case, it is not required that a user already exists in Zabbix. The user account can be created when the user logs into Zabbix for the first time.

Attention:

If JIT provisioning is enabled, a user group for deprovisioned users must be specified in the *Authentication* tab.

On top of JIT provisioning it is also possible to enable and configure SCIM (System for Cross-domain Identity Management) provisioning - *continuous* user account management for those users that have been created by user provisioning. SCIM provisioning requires a Zabbix **API token** (with Super admin permissions) for authentication into Zabbix.

For example, if a user is moved from one SAML group to another, the user will also be moved from one group to another in Zabbix; if a user is removed from a SAML group, the user will also be removed from the group in Zabbix and, if not belonging to any other group, added to the user group for deprovisioned users.

If SCIM is enabled and configured, a SAML user will be provisioned at the moment the user logs into Zabbix and continuously updated based on changes in SAML. Already existing SAML users will not be provisioned, and only provisioned users will be updated. Note that only valid media will be added to a user when the user is provisioned or updated.

If SCIM is not enabled, a SAML user will be provisioned (and later updated) at the moment the user logs into Zabbix.

Note:

If SAML authentication is enabled, users will be able to choose between logging in locally or via SAML single sign-on. If JIT provisioning is used, then only single sign-on is possible.

Setting up identity provider

In order to work with Zabbix, a SAML identity provider (onelogin.com, auth0.com, okta.com, etc.) needs to be configured in the following way:

- *Assertion Consumer URL* should be set to `<path_to_zabbix_ui>/index_sso.php?acs`
- *Single Logout URL* should be set to `<path_to_zabbix_ui>/index_sso.php?sls`

`<path_to_zabbix_ui>` examples: `https://example.com/zabbix/ui`, `http://another.example.com/zabbix`, `http://<any_public_ip_address>/zabbix`

Setting up Zabbix

Attention:

It is required to install php-openssl if you want to use SAML authentication in the frontend.

To use SAML authentication Zabbix should be configured in the following way:

1. Private key and certificate should be stored in the `ui/conf/certs/`, unless custom paths are provided in `zabbix.conf.php`.

By default, Zabbix will look in the following locations:

- `ui/conf/certs/sp.key` - SP private key file
- `ui/conf/certs/sp.crt` - SP cert file
- `ui/conf/certs/idp.crt` - IDP cert file

2. All of the most important settings can be configured in the Zabbix frontend. However, it is possible to specify additional settings in the **configuration file**.

Enable SAML authentication

Enable JIT provisioning

* IdP entity ID

* SSO service URL

SLO service URL

* Username attribute

* SP entity ID

SP name ID format

- Sign Messages
 Assertions
 AuthN requests
 Logout requests
 Logout responses

- Encrypt Name ID
 Assertions

Case-sensitive login

Configure JIT provisioning

* Group name attribute

User name attribute

User last name attribute

* User group mapping

SAML group pattern	User groups	User role	Action
zabbix* Add	Zabbix administrators	Admin role	Remove

Media type mapping ?

Name	Media type	Attribute
Add		

Enable SCIM provisioning

Configuration parameters, available in the Zabbix frontend:

Parameter	Description
<i>Enable SAML authentication</i>	Mark the checkbox to enable SAML authentication.
<i>Enable JIT provisioning</i>	Mark the checkbox to enable JIT user provisioning.
<i>IDP entity ID</i>	The unique entity identifier within the SAML identity provider.
<i>SSO service URL</i>	The URL users will be redirected to when logging in.

Parameter	Description
<i>SLO service URL</i>	The URL users will be redirected to when logging out. If left empty, the SLO service will not be used.
<i>Username attribute</i>	SAML attribute to be used as a username when logging into Zabbix. The list of supported values is determined by the identity provider. Examples: uid userprincipalname samaccountname username userusername urn:oid:0.9.2342.19200300.100.1.1 urn:oid:1.3.6.1.4.1.5923.1.1.1.13 urn:oid:0.9.2342.19200300.100.1.44
<i>SP entity ID</i>	The unique service provider identifier (if not matching, the operation will be rejected). It is possible to specify a URL or any string of data.
<i>SP name ID format</i>	Defines which name identifier format should be used. Examples: urn:oasis:names:tc:SAML:2.0:nameid-format:persistent urn:oasis:names:tc:SAML:2.0:nameid-format:transient urn:oasis:names:tc:SAML:2.0:nameid-format:kerberos urn:oasis:names:tc:SAML:2.0:nameid-format:entity
<i>Sign</i>	Mark the checkboxes to select entities for which SAML signature should be enabled: <i>Messages</i> <i>Assertions</i> <i>AuthN requests</i> <i>Logout requests</i> <i>Logout responses</i>
<i>Encrypt</i>	Mark the checkboxes to select entities for which SAML encryption should be enabled: <i>Name ID</i> <i>Assertions</i>
<i>Case-sensitive login</i>	Mark the checkbox to enable case-sensitive login (disabled by default) for usernames. E.g. disable case-sensitive login and log in with, for example, 'ADMIN' user even if the Zabbix user is 'Admin'. <i>Note that with case-sensitive login disabled the login will be denied if multiple users exist in Zabbix database with similar usernames (e.g. Admin, admin).</i>
<i>Configure JIT provisioning</i>	Mark this checkbox to show options related to JIT user provisioning.
<i>Group name attribute</i>	Specify the group name attribute for JIT user provisioning.
<i>User name attribute</i>	Specify the user name attribute for JIT user provisioning.
<i>User last name attribute</i>	Specify the user last name attribute for JIT user provisioning.
<i>User group mapping</i>	Map a SAML user group pattern to Zabbix user group and user role. This is required to determine what user group/role the provisioned user will get in Zabbix. Click on <i>Add</i> to add a mapping. The <i>SAML group pattern</i> field supports wildcards. The group name must match an existing group. If a SAML user matches several Zabbix user groups, the user becomes a member of all of them. If a user matches several Zabbix user roles, the user will get the highest permission level among them.
<i>Media type mapping</i>	Map the user's SAML media attributes (e.g. email) to Zabbix user media for sending notifications.
<i>Enable SCIM provisioning</i>	Mark this checkbox to enable SCIM 2.0 provisioning.

See examples of configuring SAML identity providers for sign-in and user provisioning into Zabbix with:

- [Microsoft Azure AD](#)
- [Okta](#)
- [Onelogin](#)

Notes on SCIM provisioning

For SCIM provisioning specify the path to the Zabbix frontend and append `api_scim.php` to it, on the identity provider side, i.e.:

`https://<path-to-zabbix-ui>/api_scim.php`

User attributes that are used in Zabbix (username, user name, user lastname and media attributes) need to be added as custom attributes and, if necessary, external namespace should be the same as user schema: `urn:ietf:params:scim:schemas:core:2.0:User`.

Advanced settings

Additional SAML parameters can be configured in the Zabbix frontend configuration file (`zabbix.conf.php`):

- `$SSO['SP_KEY'] = '<path to the SP private key file>';`
- `$SSO['SP_CERT'] = '<path to the SP cert file>';`
- `$SSO['IDP_CERT'] = '<path to the IDP cert file>';`
- `$SSO['SETTINGS']`

Note:

Zabbix uses [OneLogin's SAML PHP Toolkit](#) library (version 3.4.1). The structure of `$SSO['SETTINGS']` section should be similar to the structure used by the library. For the description of configuration options, see official library [documentation](#).

Only the following options can be set as part of `$SSO['SETTINGS']`:

- *strict*
- *baseurl*
- *compress*
- *contactPerson*
- *organization*
- *sp* (only options specified in this list)
 - *attributeConsumingService*
 - *x509certNew*
- *idp* (only options specified in this list)
 - *singleLogoutService* (only one option)
 - * *responseUrl*
 - *certFingerprint*
 - *certFingerprintAlgorithm*
 - *x509certMulti*
- *security* (only options specified in this list)
 - *signMetadata*
 - *wantNameId*
 - *requestedAuthnContext*
 - *requestedAuthnContextComparison*
 - *wantXMLValidation*
 - *relaxDestinationValidation*
 - *destinationStrictlyMatches*
 - *rejectUnsolicitedResponsesWithInResponseTo*
 - *signatureAlgorithm*
 - *digestAlgorithm*
 - *lowercaseUrlencoding*

All other options will be taken from the database and cannot be overridden. The *debug* option will be ignored.

In addition, if Zabbix UI is behind a proxy or a load balancer, the custom *use_proxy_headers* option can be used:

- *false* (default) - ignore the option;
- *true* - use X-Forwarded-* HTTP headers for building the base URL.

If using a load balancer to connect to Zabbix instance, where the load balancer uses TLS/SSL and Zabbix does not, you must indicate 'baseurl', 'strict' and 'use_proxy_headers' parameters as follows:

```
$SSO['SETTINGS']=['strict' => false, 'baseurl' => "https://zabbix.example.com/zabbix/", 'use_proxy_headers'
```

Configuration example:

```
$SSO['SETTINGS'] = [  
    'security' => [  
        'signatureAlgorithm' => 'http://www.w3.org/2001/04/xmldsig-more#rsa-sha384'  
        'digestAlgorithm' => 'http://www.w3.org/2001/04/xmldsig-more#sha384',  
        // ...  
    ],  
    // ...  
];
```

4 MFA

Overview

Multi-factor **authentication** (MFA) can be used to sign in to Zabbix, providing an additional layer of security beyond just a username and password.

With MFA, the user must exist in Zabbix, must provide Zabbix credentials when logging in, and must also prove their identity by other means, usually, a code generated by an authenticator app on the user's phone.

Multiple MFA methods are available, allowing users to choose the option that best fits their security requirements and preferences. These methods are Time-Based One-Time Password (TOTP) and Duo Universal Prompt.

Configuration

Name	Type	User groups	Default	Action
Zabbix TOTP	TOTP	5	<input checked="" type="radio"/>	Remove
Zabbix Duo	Duo Universal Prompt	1	<input type="radio"/>	Remove

Configuration parameters:

Parameter	Description
<i>Enable multi-factor authentication</i>	Mark the checkbox to enable multi-factor authentication.
<i>Methods</i>	Click <i>Add</i> to configure an MFA method (see method configuration below).

Method configuration

Type: TOTP
* Name: Zabbix TOTP
Hash function: SHA-1
Code length: 6

Add Cancel

Method configuration parameters:

Parameter	Description
<i>Type</i>	Select the type of MFA method: TOTP - use an authenticator app to generate time-based one-time passwords; Duo Universal Prompt - use the Duo authentication service to provide multi-factor authentication.
<i>Name</i>	Enter a name that is displayed as the account name to all MFA users in authenticator apps (for example, "Zabbix").
<i>Hash function</i>	Select the hash function (SHA-1, SHA-256, or SHA-512) for generating TOTP codes. This parameter is available if the MFA method type is set to "TOTP". Note that choosing SHA-256 or SHA-512 may significantly limit compatibility, as many applications currently do not support these functions.

Parameter	Description
<i>Code length</i>	Select the verification code length (6 or 8). This parameter is available if MFA method type is set to "TOTP".
<i>API hostname</i>	Enter the API hostname provided by the Duo authentication service. This parameter is available if MFA method type is set to "Duo Universal Prompt".
<i>Client ID</i>	Enter the client ID provided by the Duo authentication service. This parameter is available if MFA method type is set to "Duo Universal Prompt".
<i>Client secret</i>	Enter the client secret provided by the Duo authentication service. This parameter is available if MFA method type is set to "Duo Universal Prompt".

Configuration examples

This section provides examples of configuring MFA using **Time-Based One-Time Password (TOTP)** and **Duo Universal Prompt**.

TOTP

For TOTP, users must verify their identity using an authenticator app (for example, the [Google Authenticator](#) app).

1. Go to the MFA settings in Zabbix under *Users* → *Authentication* and enable multi-factor authentication.
2. Add a new MFA **method** with the following configuration:
 - Type: TOTP
 - Name: Zabbix TOTP
 - Hash function: SHA-1
 - Code length: 6
3. Go to *Users* → *User groups* and create a new user group with the following **configuration**:
 - Group name: TOTP group
 - Users: Admin
 - Multi-factor authentication: Default (or "Zabbix TOTP" if it is not set as default)
4. Log out of Zabbix and log back in using your credentials. Upon successful login, you will be prompted to enroll in MFA, displaying a QR code and a secret key.

ZABBIX

Scan this QR code

Please scan and get your verification code displayed in your authenticator app.



Unable to scan? You can use SHA1 secret key to manually configure your authenticator app:
NVC4MMZGQHPQMOTDOYBA7BO4B2OXHRUY

Verification code

Sign in

5. Scan the QR code or enter the secret key into the Google Authenticator app. The app will generate a verification code which you should enter to complete the login process.

6. For subsequent logins, retrieve the verification code from the Google Authenticator app and enter it during login.

Duo Universal Prompt

For Duo Universal Prompt, users must verify their identity using the [Duo Mobile](#) authenticator app.

Attention:

The Duo Universal Prompt MFA method requires the installation of the [php-curl](#) extension, access to Zabbix over HTTPS, and permission for outbound connections to Duo servers. Moreover, if you have [enabled Content Security Policy \(CSP\) on the web server](#), make sure to add "duo.com" to the CSP directive in your virtual host's configuration file.

1. Signup for a free Duo admin account at [Duo Signup](#).
2. Open the Duo Admin Panel, go to *Applications* → [Protect an Application](#), search for the *Web SDK* application, and click *Protect*.
3. Note the credentials (Client ID, Client secret, API hostname) required for configuring the MFA method in Zabbix.
4. Go to MFA settings in Zabbix under *Users* → *Authentication* and enable multi-factor authentication.
5. Add a new MFA [method](#) with the following configuration:
 - Type: Duo Universal Prompt
 - Name: Zabbix Duo
 - API hostname: (use API hostname from Duo)
 - Client ID: (use Client ID from Duo)

- Client secret: (use Client secret from Duo)
6. Go to *Users* → *User groups* and create a new user group with the following configuration:
 - Group name: Duo group
 - Users: Admin
 - Multi-factor authentication: Default (or "Zabbix Duo" if it is not set as default)
 7. Log out of Zabbix and log back in using your credentials. Upon successful login, you will be prompted to enroll in MFA and redirected to Duo. Complete the Duo setup and verify your user with your phone's Duo app to log in.
 8. For subsequent logins, use the appropriate MFA method provided by the Duo app (such as retrieving a verification code, responding to push notifications, or using hard keys), and enter the required information during login.

9 Administration

Overview

The Administration menu is for administrative functions of Zabbix. This menu is available to **SuperAdmin** user type users only.

1 General

Overview

The *Administration* → *General* section contains a number of subsections for setting frontend-related defaults and customizing Zabbix.

The list of available subsections appears upon pressing on *General* in the *Administration* menu section. It is also possible to switch between subsections by using the title dropdown in the top left corner.

1 GUI

This section provides customization of several frontend-related defaults.

Default language	English (en_US) ▾
Default time zone	(UTC-08:00) America/Los_Angeles ▾
Default theme	Blue ▾
* Limit for search and filter results	1000
* Max number of columns and rows in overview tables	50
* Max count of elements to show inside table cell	20
Show warning if Zabbix server is down	<input checked="" type="checkbox"/>
* Working time	{\$WORKING_HOURS}
Show technical errors	<input type="checkbox"/>
* Max history display period	24h
* Time filter default period	1h
* Max period for time selector	2y

Configuration parameters:

Parameter	Description
<i>Default language</i>	Default language for users who have not specified a language in their profiles and guest users. For more information, see Installation of additional frontend languages .
<i>Default time zone</i>	Default time zone for users who have not specified a time zone in their profiles and guest users.
<i>Default theme</i>	Default theme for users who have not specified a theme in their profiles and guest users.
<i>Limit for search and filter results</i>	Maximum amount of elements (rows) that will be displayed in a web-interface list, for example, in <i>Data collection</i> → <i>Hosts</i> . <i>Note:</i> If set to, for example, '50', only the first 50 elements will be displayed in all affected frontend lists. If some list contains more than fifty elements, the indication of that will be the '+' sign in <i>"Displaying 1 to 50 of 50+ found"</i> . Also, if filtering is used and still there are more than 50 matches, only the first 50 will be displayed. <i>Note:</i> that increasing the value of this parameter may lead to decreased performance and increased memory consumption on the web server side.
<i>Max number of columns
and rows in overview tables</i>	Maximum number of columns and rows to display in the <i>Trigger overview</i> dashboard widget. The same limit applies to both columns and rows. If more rows and/or columns than shown exist, the system will display a warning at the bottom of the table: "Not all results are displayed. Please provide more specific search criteria."
<i>Max count of elements
to show inside table cell</i>	For entries that are displayed in a single table cell, no more than configured here will be shown.
<i>Show warning if Zabbix server is down</i>	This parameter enables a warning message to be displayed in a browser window if the Zabbix server cannot be reached (possibly down). The message remains visible even if the user scrolls down the page. When hovered over, the message is temporarily hidden to reveal the contents underneath it.
<i>Working time</i>	This system-wide parameter defines working hours. In graphs, working time is displayed as a white background and non-working time is displayed as gray. See Time period specification page for description of the time format. User macros are supported.
<i>Show technical errors</i>	If checked, all registered users will be able to see technical errors (PHP/SQL). If unchecked, the information is only available to Zabbix Super Admins and users belonging to the user groups with enabled debug mode .
<i>Max history display period</i>	Maximum time period for which to display historical data in <i>Monitoring</i> subsections: <i>Latest data</i> , <i>Web</i> , and in the <i>Top items</i> dashboard widget. Allowed range: 24 hours (default) - 1 week. Time suffixes , e.g. 1w (one week), 36h (36 hours), are supported.
<i>Time filter default period</i>	Time period to be used in graphs and dashboards by default. Allowed range: 1 minute - 10 years (default: 1 hour). Time suffixes , e.g. 10m (ten minutes), 5w (five weeks), are supported. <i>Note:</i> when a user changes the time period while viewing a graph, this time period is stored as user preference, replacing the global default or a previous user selection.
<i>Max period for time selector</i>	Maximum available time period for graphs and dashboards. Users will not be able to visualize older data. Allowed range: 1 year - 10 years (default: 2 years). Time suffixes , e.g. 1y (one year), 365w (365 weeks), are supported.

2 Autoregistration

In this section, you can configure the encryption level for active agent autoregistration.

Encryption level No encryption

PSK

* PSK identity

* PSK

Parameters marked with an asterisk are mandatory.

Configuration parameters:

Parameter	Description
<i>Encryption level</i>	Select one or both options for encryption level: No encryption - unencrypted connections are allowed PSK - TLS encrypted connections with a pre-shared key are allowed
<i>PSK identity</i>	Enter the pre-shared key identity string. This field is only available if 'PSK' is selected as <i>Encryption level</i> . Do not put sensitive information in the PSK identity, it is transmitted unencrypted over the network to inform a receiver which PSK to use.
<i>PSK</i>	Enter the pre-shared key (an even number of hexadecimal characters). Maximum length: 512 hex-digits (256-byte PSK) if Zabbix uses GnuTLS or OpenSSL library, 64 hex-digits (32-byte PSK) if Zabbix uses mbed TLS (PolarSSL) library. Example: 1f87b595725ac58dd977beef14b97461a7c1045b9a1c963065002c5473194952 This field is only available if 'PSK' is selected as <i>Encryption level</i> .

See also: [Secure autoregistration](#)

3 Timeouts

In this section, it is possible to set global item-type timeouts and network timeouts. All fields in this form are mandatory.

☰ Timeouts ▾

Timeouts for item types

* Zabbix agent	<input type="text" value="3s"/>
* Simple check	<input type="text" value="3s"/>
* SNMP agent	<input type="text" value="3s"/>
* External check	<input type="text" value="3s"/>
* Database monitor	<input type="text" value="3s"/>
* HTTP agent	<input type="text" value="3s"/>
* SSH agent	<input type="text" value="3s"/>
* TELNET agent	<input type="text" value="3s"/>
* Script	<input type="text" value="3s"/>
* Browser	<input type="text" value="60s"/>

Network timeouts for UI

* Communication	<input type="text" value="3s"/>
* Connection	<input type="text" value="3s"/>
* Media type test	<input type="text" value="65s"/>
* Script execution	<input type="text" value="60s"/>
* Item test	<input type="text" value="60s"/>
* Scheduled report test	<input type="text" value="60s"/>

Parameter	Description
<i>Timeouts for item types</i>	<p>How many seconds to wait for a response from a monitored item (based on its type). Allowed range: 1 - 600s (default: 3s; default for Browser item type: 60s). Time suffixes, e.g. 30s, 1m, and user macros are supported.</p> <p>Supported item types:</p> <ul style="list-style-type: none"> - Zabbix agent (both passive and active checks) - Simple check (except <code>icmping*</code>, <code>vmware.*</code> items) - SNMP agent (only for SNMP walk [OID] and get [OID] items) - External check - Database monitor - HTTP agent - SSH agent - TELNET agent - Script - Browser <p>Note that if a proxy is used and has timeouts configured, the timeout settings of the proxy will override the global ones. If there are timeouts set for specific items, they will override the proxy and global settings.</p>
<i>Network timeouts for UI</i>	<p>Communication How many seconds to wait before closing an idle socket (if a connection to Zabbix server has been established earlier, but frontend cannot finish data reading/sending operation during this time, the connection will be dropped). Allowed range: 1 - 300s (default: 3s).</p> <p>Connection How many seconds to wait before stopping an attempt to connect to Zabbix server. Allowed range: 1 - 30s (default: 3s).</p> <p>Media type test How many seconds to wait for a response when testing a media type. Allowed range: 1 - 300s (default: 65s).</p> <p>Script execution How many seconds to wait for a response when executing a script. Allowed range: 1 - 300s (default: 60s).</p> <p>Item test How many seconds to wait for returned data when testing an item. Allowed range: 1 - 600s (default: 60s).</p> <p>Scheduled report test How many seconds to wait for returned data when testing a scheduled report. Allowed range: 1 - 300s (default: 60s).</p>

4 Images

The Images section displays all the images available in Zabbix. Images are stored in the database.

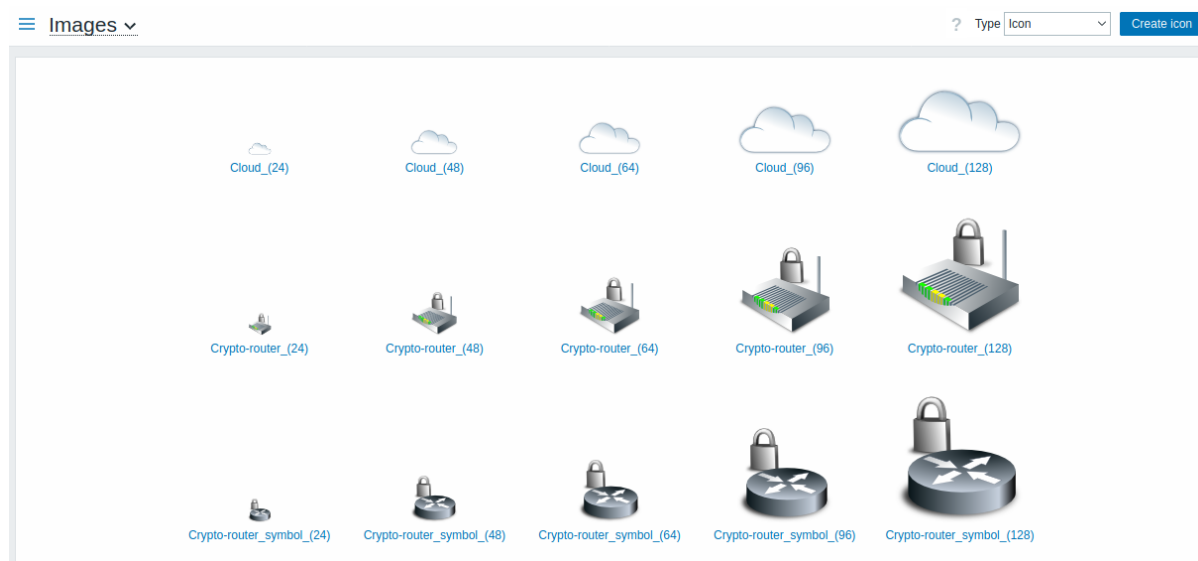

The *Type* dropdown allows you to switch between icon and background images:

- Icons are used to display **network map** elements
- Backgrounds are used as background images of network maps

Adding image

You can add your own image by clicking on the *Create icon* or *Create background* button in the top right corner.

Image attributes:

Parameter	Description
<i>Name</i>	Unique name of an image.
<i>Upload</i>	Select the file (PNG, JPEG, GIF) from a local system to be uploaded to Zabbix. <i>Note</i> that it may be possible to upload other formats that will be converted to PNG during upload. GD library is used for image processing, therefore formats that are supported depend on the library version used (2.0.28 or higher is required by Zabbix).

Note:

Maximum size of the upload file is limited by the value of ZBX_MAX_IMAGE_SIZE that is 1024x1024 bytes or 1 MB.

The upload of an image may fail if the image size is close to 1 MB and the `max_allowed_packet` MySQL configuration parameter is at a default of 1MB. In this case, increase the [max_allowed_packet](#) parameter.

5 Icon mapping

This section allows creating the mapping of certain hosts with certain icons. Host inventory field information is used to create the mapping.

The mappings can then be used in [network map configuration](#) to assign appropriate icons to matching hosts automatically.

To create a new icon map, click on *Create icon map* in the top right corner.

Configuration parameters:

Parameter	Description
<i>Name</i>	Unique name of icon map.
<i>Mappings</i>	A list of mappings. The order of mappings determines which one will have priority. You can move mappings up and down the list with drag-and-drop.
<i>Inventory field</i>	Host inventory field that will be looked into to seek a match.
<i>Expression</i>	Regular expression describing the match.
<i>Icon</i>	Icon to use if a match for the expression is found.
<i>Default</i>	Default icon to use.

6 Regular expressions

This section allows creating custom regular expressions that can be used in several places in the frontend. See [Regular expressions](#) section for details.

7 Trigger displaying options

This section allows customizing how trigger status is displayed in the frontend and [trigger severity](#) names and colors.

Use custom event status colors

* Unacknowledged PROBLEM events blinking

* Acknowledged PROBLEM events blinking

* Unacknowledged RESOLVED events blinking

* Acknowledged RESOLVED events blinking

* Display OK triggers for

* On status change triggers blink for

* Not classified

* Information

* Warning

* Average

* High

* Disaster



Parameter	Description
<i>Use custom event status colors</i>	Checking this parameter turns on the customization of colors for acknowledged/unacknowledged problems.
<i>Unacknowledged PROBLEM events, Acknowledged PROBLEM events, Unacknowledged RESOLVED events, Acknowledged RESOLVED events</i>	Enter new color code or click on the color to select a new one from the provided palette. If <i>blinking</i> checkbox is marked, triggers will blink for some time upon the status change to become more visible.
<i>Display OK triggers for</i>	Time period for displaying OK triggers. Allowed range: 0 - 24 hours. Time suffixes , e.g. 5m, 2h, 1d, are supported.
<i>On status change triggers blink for</i>	Length of trigger blinking. Allowed range: 0 - 24 hours. Time suffixes , e.g. 5m, 2h, 1d, are supported.

Parameter	Description
<i>Not classified, Information, Warning, Average, High, Disaster</i>	Custom severity names and/or colors to display instead of system default. Enter new color code or click on the color to select a new one from the provided palette. Note that custom severity names entered here will be used in all locales. If you need to translate them to other languages for certain users, see Customizing trigger severities page.

8 Geographical maps

This section allows selecting geographical map tile service provider and configuring service provider settings for the Geomap [dashboard widget](#). To provide visualization using the geographical maps, Zabbix uses open-source JavaScript interactive maps library Leaflet. Please note that Zabbix has no control over the quality of images provided by third-party tile providers, including the predefined tile providers.

* Tile provider

* Tile URL

* Max zoom level

Parameter	Description
Tile provider	Select one of the available tile service providers or select <i>Other</i> to add another tile provider or self-hosted tiles (see Using a custom tile service provider).
Tile URL	The URL template (up to 2048 characters) for loading and displaying the tile layer on geographical maps. This field is editable only if <i>Tile provider</i> is set to <i>Other</i> . The following placeholders are supported: <ul style="list-style-type: none"> {s} represents one of the available subdomains; {z} represents zoom level parameter in the URL; {x} and {y} represent tile coordinates; {r} can be used to add "@2x" to the URL to load retina tiles. Example: <code>https://{s}.example.com/{z}/{x}/{y}{r}.png</code>
Attribution text	Tile provider attribution text to be displayed in a small text box on the map. This field is visible only if <i>Tile provider</i> is set to <i>Other</i> .
Max zoom level	Maximum zoom level of the map. This field is editable only if <i>Tile provider</i> is set to <i>Other</i> .

Using a custom tile service provider

The Geomap widget is capable to load raster tile images from a custom self-hosted or a third-party tile provider service. To use a custom third-party tile provider service or a self-hosted tile folder or server, select *Other* in the *Tile provider* field and specify the custom URL in the *Tile URL* field using proper placeholders.

9 Modules

This section allows to administer custom, as well as built-in [frontend modules](#).

☰ Modules ?

Name ▲	Version	Author	Description	Status
<input type="checkbox"/> Action log	1.0	Zabbix	Displays records about executed action operations (notifications, remote commands).	Enabled
<input type="checkbox"/> Clock	1.0	Zabbix	Displays local, server, or specified host time.	Enabled
<input type="checkbox"/> Custom module	2.0	Example.com	Short description of the module.	Enabled
<input type="checkbox"/> Data overview	1.0	Zabbix	Displays the latest item data and current status of each item for selected hosts.	Enabled
<input type="checkbox"/> Discovery status	1.0	Zabbix	Displays the status summary of the active network discovery rules.	Enabled

Click on *Scan directory* to register/unregister any custom modules. Registered modules will appear in the list; unregistered modules will be removed from the list.

Click on the module status in the list to enable/disable a module. You may also mass enable/disable modules by selecting them in the list and then clicking on the *Enable/Disable* buttons below the list.

Click on the module name in the list to view its **details** in a pop-up window.

Module ? ×

Name Action log

Version 1.0

Author Zabbix

Description Displays records about executed action operations (notifications, remote commands).

Directory widgets/actionlog

Namespace Widgets\ActionLog

URL https://www.zabbix.com/documentation/7.0/en/manual/web_interface/frontend_sections/dashboards/...

Enabled

Update **Cancel**

Module status can also be updated in the module details pop-up window; to do this, mark/unmark the *Enabled* checkbox and then click on *Update*.

You may filter modules by name or status (enabled/disabled).

10 Connectors

This section allows to configure connectors for Zabbix data **streaming to external systems** over HTTP.

Connectors ? **Create connector**

<input type="checkbox"/> Name <small>▲</small>	Data type	Status
<input type="checkbox"/> Event export to Example Service	Events	Enabled
<input type="checkbox"/> Item value export to Example Service	Item values	Enabled

0 selected **Enable** **Disable** **Delete** Filter Displaying 2 of 2 found

Click on *Create connector* to configure a new **connector**.

You may filter connectors by name or status (enabled/disabled). Click on the connector status in the list to enable/disable a connector. You may also mass enable/disable connectors by selecting them in the list and then clicking on the *Enable/Disable* buttons below the list.

11 Other

This section allows configuring miscellaneous other frontend parameters.

Frontend URL

* Group for discovered hosts

Default host inventory mode Disabled Manual Automatic

User group for database down message

Log unmatched SNMP traps

Authorization

* Login attempts

* Login blocking interval

Storage of secrets

Vault provider HashiCorp Vault CyberArk Vault

Security

Validate URI schemes

* Use X-Frame-Options HTTP header

Use iframe sandboxing

Parameter	Description
<i>Frontend URL</i>	URL (up to 2048 characters) to Zabbix web interface. This parameter is used by Zabbix web service for communication with frontend and should be specified to enable scheduled reports.
<i>Group for discovered hosts</i>	Hosts discovered by network discovery and agent autoregistration will be automatically placed in the host group, selected here.
<i>Default host inventory mode</i>	Default mode for host inventory. It will be followed whenever a new host or host prototype is created by server or frontend unless overridden during host discovery/autoregistration by the <i>Set host inventory mode</i> operation.
<i>User group for database down message</i>	User group for sending alarm message or 'None'. Zabbix server depends on the availability of the backend database. It cannot work without a database. If the database is down, selected users can be notified by Zabbix. Notifications will be sent to the user group set here using all configured user media entries. Zabbix server will not stop; it will wait until the database is back again to continue processing. Notification consists of the following content: [MySQL\ PostgreSQL] database <DB Name> [on <DB Host>:<DB Port>] is not available: <error message depending on the type of DBMS (database)> <DB Host> is not added to the message if it is defined as an empty value and <DB Port> is not added if it is the default value ("0"). The alert manager (a special Zabbix server process) tries to establish a new connection to the database every 10 seconds. If the database is still down the alert manager repeats sending alerts, but not more often than every 15 minutes.
<i>Log unmatched SNMP traps</i>	Log SNMP trap if no corresponding SNMP interfaces have been found.

Authorization

Parameter	Description
<i>Login attempts</i>	Number of unsuccessful login attempts before the possibility to log in gets blocked.
<i>Login blocking interval</i>	Period of time for which logging in will be prohibited when <i>Login attempts</i> limit is exceeded. Allowed range: 0 - 3600 seconds. Time suffixes , e.g. 90s, 5m, 1h, are supported.

Storage of secrets

Vault provider parameter allows selecting secret management software for storing **user macro** values. Supported options:

- HashiCorp Vault (default)
- CyberArk Vault

See also: [Storage of secrets](#).

Security

Parameter	Description
<i>Validate URI schemes</i>	Unmark this checkbox to disable URI scheme validation (enabled by default). If marked, you can specify a comma-separated list of allowed URI schemes (default: http,https,ftp,file,mailto,tel,ssh). Applies to all fields in the frontend where URIs are used (for example, map element URLs).
<i>Use X-Frame-Options HTTP header</i>	Unmark this checkbox to disable the HTTP X-Frame-options header (not recommended). If marked, you can specify the value of the HTTP X-Frame-options header. Supported values: SAMEORIGIN (default) or 'self' (must be single-quoted) - the page can only be displayed in a frame on the same origin as the page itself; DENY or 'none' (must be single-quoted) - the page cannot be displayed in a frame, regardless of the site attempting to do so; a string of space-separated hostnames ; adding 'self' (must be single-quoted) to the list allows the page to be displayed in a frame on the same origin as the page itself. Note that using 'self' or 'none' without single quotes will result in them being regarded as hostnames.
<i>Use iframe sandboxing</i>	Unmark this checkbox to disable putting the retrieved URL content into sandbox (not recommended). If marked, you can specify the iframe sandboxing exceptions; unspecified restrictions will still be applied. If this field is empty, all sandbox attribute restrictions apply. For more information, see the description of the sandbox attribute.

2 Audit log

Overview

This section allows configuring audit log settings.

The following parameters are available:

Parameter	Description
<i>Enable audit logging</i>	Enable (default) or disable audit logging.
<i>Log system actions</i>	Enable (default) or disable audit logging of low-level discovery, network discovery and autoregistration activities performed by the server (System user).
<i>Enable internal housekeeping</i>	Enable (default) or disable internal housekeeping for audit log records.
<i>Data storage period</i>	Amount of days audit log records should be kept before being removed by the housekeeper. Mandatory if housekeeping is enabled. Default: 31 days.

3 Housekeeping

Overview

The housekeeper is a periodical process, executed by Zabbix server. The process removes outdated information and information deleted by user.

Events and alerts

Enable internal housekeeping

* Trigger data storage period

* Service data storage period

* Internal data storage period

* Network discovery data storage period

* Autoregistration data storage period

Services

Enable internal housekeeping

* Data storage period

User sessions

Enable internal housekeeping

* Data storage period

History

Enable internal housekeeping

Override item history period

* Data storage period

Trends

Enable internal housekeeping

Override item trend period

* Data storage period

Audit log

[Audit settings](#)

In this section housekeeping tasks can be enabled or disabled on a per-task basis separately for: events and alerts/IT services/user sessions/history/trends. Audit housekeeping settings are available in a separate [menu section](#).

If housekeeping is enabled, it is possible to set for how many days data records will be kept before being removed by the housekeeper.

Deleting an item/trigger will also delete problems generated by that item/trigger.

Also, an event will only be deleted by the housekeeper if it is not associated with a problem in any way. This means that if an event is either a problem or recovery event, it will not be deleted until the related problem record is removed. The housekeeper will delete problems first and events after, to avoid potential problems with stale events or problem records.

For history and trends an additional option is available: *Override item history period* and *Override item trend period*. This option allows setting globally for how many days item history/trends will be stored (1 hour to 25 years; or "0"), overriding the respective

Store up to values set for individual items in the **item configuration** form. Note that the storage period will not be overridden for items that have configuration option *Do not store* enabled.

It is possible to override the history/trend storage period even if internal housekeeping is disabled. Thus, when using an external housekeeper, the history storage period could be set using the history *Data storage period* field.

Attention:

If using TimescaleDB, in order to take full advantage of TimescaleDB automatic partitioning of history and trends tables, *Override item history period* and *Override item trend period* options must be enabled as well as *Enable internal housekeeping* option for history and trends. Otherwise, data kept in these tables will still be stored in partitions, however, the housekeeper will not drop outdated partitions, and warnings about incorrect configuration will be displayed. When dropping of outdated partitions is enabled, Zabbix server and frontend will no longer keep track of deleted items, and history for deleted items will be cleared when an outdated partition is deleted.

Time suffixes are supported in the period fields, e.g., 1d (one day), 1w (one week). The minimum is 1 day (1 hour for history), the maximum - 25 years.

The *Reset defaults* button allows reverting any changes made.

4 Proxies

Overview

In the *Administration* → *Proxies* section proxies for **distributed monitoring** can be configured in the Zabbix frontend.

Proxies

A listing of existing proxies with their details is displayed.

Name	Mode	Encryption	State	Version	Last seen (age)	Item count	Required vps	Hosts
Riga: proxy01	Active	PSK CERT	Online	7.0.0	1m 48s	202	0.02	host001, host005, host015, host019, host024
Riga: proxy02	Passive	None	Online	6.4.0	2m 50s	305	0.12	host002, host003, host004, host011, host020
Riga: proxy03	Active	CERT	Online	6.4.0	5m 51s	144	0	host006, host007, host008, host009, host010
Riga: proxy04	Passive	None	Online	6.4.0	4m 46s	442	0.56	host012, host013, host014, host016, host017
Riga: proxy05	Active	None	Online	6.4.0	1m 43s	96	0	host018, host021, host022, host023, host025
Riga: proxy06	Active	None	Online	6.4.0	7m 49s	55	0.4	host026, host027, host028, host029, host030
proxy07	Active	None	Offline		Never			
Berlin: proxy08	Active	None	Offline		Never			host031, host032, host033
London: proxy09	Active	None	Offline		Never			host034, host035, host036, host037, host038, host039, host040
Paris: proxy10	Passive	CERT	Online	5.2.1	5m 58s	16	0	host041, host042, host043, host044, host045
Paris: proxy11	Active	None	Online	6.4.0	6m 8s	88	0	host041, host042, host043, host044, host045
Paris: proxy12	Active	None	Online	6.4.0	4m 18s	160	1.21	host041, host042, host043, host044, host045
Warsaw: proxy13	Active	None	Online	6.0.6	6m 3s	45	0	host046, host047, host048, host049, host050
Warsaw: proxy14	Passive	None	Online	6.4.0	3m	33	0.6	host046, host047, host048, host049, host050
Warsaw: proxy15	Active	None	Online	6.4.0	2m 9s	179	0	host046, host047, host048, host049, host050

Displayed data:

Column	Description
Name	Name of the proxy. Clicking on the proxy name opens the proxy configuration form . If the proxy belongs to a proxy group, the group name is displayed before the proxy name, as a gray link. Clicking on the group name opens the proxy group configuration form .
Mode	Proxy mode is displayed - <i>Active</i> or <i>Passive</i> .
Encryption	Encryption status for connections from the proxy is displayed: None - no encryption; PSK - using pre-shared key; Cert - using certificate.
State	Proxy state is displayed - <i>Online</i> , <i>Offline</i> , or <i>Unknown</i> .
Version	Proxy version (three digit version number). If proxy is outdated or unsupported, version number is highlighted (red) and info status icon (yellow or red) is displayed. Hover over the icon for details.
Last seen (age)	The time when the proxy was last seen by the server is displayed.
Item count	The number of enabled items on enabled hosts assigned to the proxy is displayed.

Column	Description
<i>Required vps</i>	Required proxy performance is displayed (the number of values that need to be collected per second).
<i>Hosts</i>	Count of enabled hosts assigned to the proxy is displayed and hosts monitored by the proxy are listed. Clicking on the host name opens the host configuration form.

To configure a new proxy, click on the *Create proxy* button in the top right-hand corner.

Mass editing options

Buttons below the list offer some mass-editing options:

- *Refresh configuration* - refresh configuration of the proxies;
- *Enable hosts* - change the status of hosts monitored by the proxy to *Monitored*;
- *Disable hosts* - change the status of hosts monitored by the proxy to *Not monitored*;
- *Delete* - delete the proxies.

To use these options, mark the checkboxes before the respective proxies, then click on the required button.

Using filter

You can use the filter to display only the proxies you are interested in. For better search performance, data is searched with macros unresolved.

The *Filter* link is available above the list of proxies. If you click on it, a filter becomes available where you can filter proxies by name, mode and version. Note that the filter option *Outdated* displays both outdated (partially supported) and unsupported proxies.

5 Proxy groups

Overview

In *Administration* → *Proxy groups* it is possible to configure proxy groups.

Proxy groups are used in **proxy load balancing** with automated distribution of hosts between proxies and high availability between proxies.

Proxy groups

A listing of existing proxy groups with their details is displayed.

Name	State	Failover period	Online proxies	Minimum proxies	Proxies
Amsterdam		1m	0	3	
Berlin	Unknown	1m	0	1	1 proxy08
London	Offline	3m	0	1	1 proxy09
Paris	Recovering	5m	2	3	3 proxy10, proxy11, proxy12
Riga	Online	5m	5	5	6 proxy01, proxy02, proxy03, proxy04, proxy05, proxy06
Warsaw	Degrading	5m	3	3	3 proxy13, proxy14, proxy15

Displayed data:

Column	Description
<i>Name</i>	Name of the proxy group. Clicking on the proxy group name opens the proxy group configuration form .

Column	Description
State	State of the proxy group is displayed: Unknown - if group was created with Zabbix server down or Zabbix server has not yet updated the state; Online - the minimum number of proxies are online; Degrading - the transition from online to offline status; Offline - less than the minimum number of proxies are online; Recovering - the transition from offline to online status. The state is not displayed if there are no proxies in the group.
Failover period	The period in seconds before failover is executed is displayed. Time suffixes are supported.
Online proxies	The number of online proxies is displayed. If the number is below the group minimum, it is displayed is red.
Minimum proxies	The minimum number of online proxies required for the group to be Online is displayed.
Proxies	Count of proxies of the group is displayed and proxies of the group are listed, with links to the proxy configuration form. The maximum number of listed proxies is limited by the <i>Max count of elements to show inside table cell</i> value.

To configure a new proxy group, click on the *Create proxy groups* button in the top right-hand corner.

Mass editing options

Buttons below the list offer some mass-editing options:

- *Delete* - delete the proxy groups.

To use these options, mark the checkboxes before the respective proxy groups, then click on the required button.

Using filter

You can use the filter to display only the proxy groups you are interested in. For better search performance, data is searched with macros unresolved.

The *Filter* link is available above the list of proxy groups. If you click on it, a filter becomes available where you can filter proxy groups by name and status.

6 Macros

Overview

This section allows to define system-wide **user macros** as name-value pairs. Note that macro values can be kept as plain text, secret text or Vault secret. Adding a description is also supported.

Macro	Value		Description
{MYSQL_PASSWORD}	*****		description
{MYSQL_USERNAME}	*****		description
{SECRET_PASSWORD}	path/to/secret:password		description
{SECRET_USERNAME}	path/to/secret:username		description
{SNMP_COMMUNITY}	public		description
{WORKING_HOURS}	1-5,09:00-18:00		description

[Add](#)

7 Queue

Overview

In the *Administration* → *Queue* section items that are waiting to be updated are displayed.

Ideally, when you open this section it should all be "green" meaning no items in the queue. If all items are updated without delay, there are none waiting. However, due to lacking server performance, some items may get delayed and the information is displayed in this section. For more details, see the [Queue](#) section.

Note:

The queue is available only if Zabbix server is running. Items are not counted in the queue if the item interface becomes unavailable due to connection problems or agent not working properly.

The *Administration* → *Queue* section contains the following pages:

- Queue overview — displays queue by item type;
- Queue overview by proxy — displays queue by proxy;
- Queue details — displays a list of delayed items.

The list of available pages appears upon pressing on *Queue* in the *Administration* menu section. It is also possible to switch between pages by using a title dropdown in the top left corner.

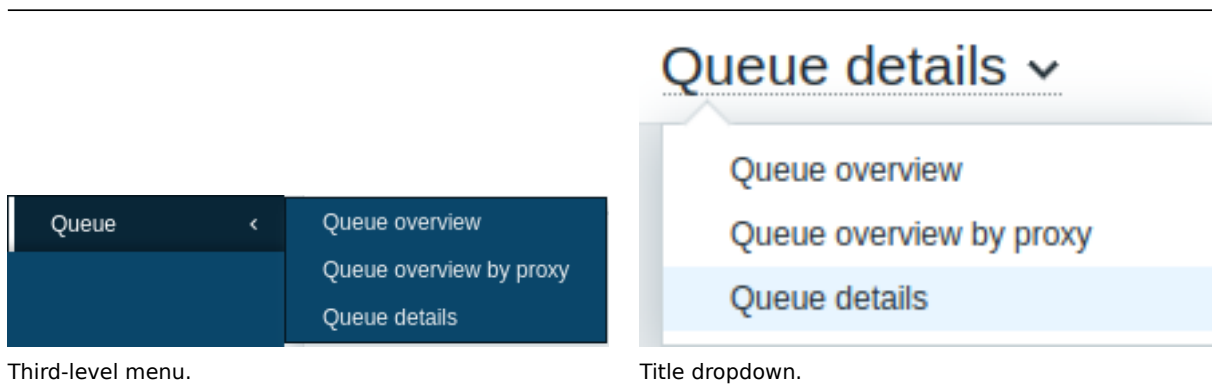

Overview by item type

In this screen it is easy to locate if the problem is related to one or several item types.

Queue overview ▾							?
Items	5 seconds	10 seconds	30 seconds	1 minute	5 minutes	More than 10 minutes	
Zabbix agent	1	11	1	0	0	0	
Zabbix agent (active)	0	0	0	0	0	0	
Simple check	0	0	0	0	0	0	
SNMPv1 agent	0	0	0	0	0	0	
SNMPv2 agent	0	0	0	0	0	0	
SNMPv3 agent	0	0	0	0	0	0	
Zabbix internal	0	0	0	0	0	0	
Zabbix aggregate	0	0	0	0	0	0	
External check	0	0	0	0	0	0	
Database monitor	0	0	0	0	0	0	
HTTP agent	0	0	0	0	0	0	

Each line contains an item type. Each column shows the number of waiting items - waiting for 5-10 seconds/10-30 seconds/30-60 seconds/1-5 minutes/5-10 minutes or over 10 minutes respectively.

Overview by proxy

In this screen it is easy to locate if the problem is related to one of the proxies or the server.

Queue overview by proxy ▾							?
Proxy	5 seconds	10 seconds	30 seconds	1 minute	5 minutes	More than 10 minutes	
Remote proxy	0	8	11	0	0	0	
Server	0	0	0	0	0	0	
						Total: 2	

Each line contains a proxy, with the server last in the list. Each column shows the number of waiting items - waiting for 5-10 seconds/10-30 seconds/30-60 seconds/1-5 minutes/5-10 minutes or over 10 minutes respectively.

List of waiting items

In this screen, each waiting item is listed.

☰ Queue details ▾

?

Scheduled check	Delayed by	Host	Name	Proxy
2019-09-02 11:46:40	58s	My host	CPU idle time	Remote proxy
2019-09-02 11:46:41	57s	My host	CPU interrupt time	Remote proxy
2019-09-02 11:46:42	56s	My host	CPU iowait time	Remote proxy
2019-09-02 11:46:43	55s	My host	CPU nice time	Remote proxy
2019-09-02 11:46:44	54s	My host	CPU softirq time	Remote proxy
2019-09-02 11:46:45	53s	My host	CPU steal time	Remote proxy
2019-09-02 11:46:46	52s	My host	CPU system time	Remote proxy

Displayed data:

Column	Description
<i>Scheduled check</i>	The time when the check was due is displayed.
<i>Delayed by</i>	The length of the delay is displayed.
<i>Host</i>	Host of the item is displayed.
<i>Name</i>	Name of the waiting item is displayed.
<i>Proxy</i>	The proxy name is displayed, if the host is monitored by proxy.

Possible error messages

You may encounter a situation when no data is displayed and the following error message appears:



Error message in this case is the following:

Cannot display item queue. Permission denied

This happens when the PHP configuration parameters in the *zabbix.conf.php* file - `$ZBX_SERVER` or both `$ZBX_SERVER` and `$ZBX_SERVER_PORT` - point to an existing Zabbix server that uses a different database.

3 User settings

Overview

Depending on user role permissions, the *User settings* section may contain the following pages:

- *Profile or User profile* - for customizing certain Zabbix frontend features.
- *API tokens* - for managing API tokens assigned to the current user.

The list of available pages appears upon clicking the  user icon near the bottom of the Zabbix menu (not available for the *guest* user). It is also possible to switch between pages by using the title dropdown in the top left corner.

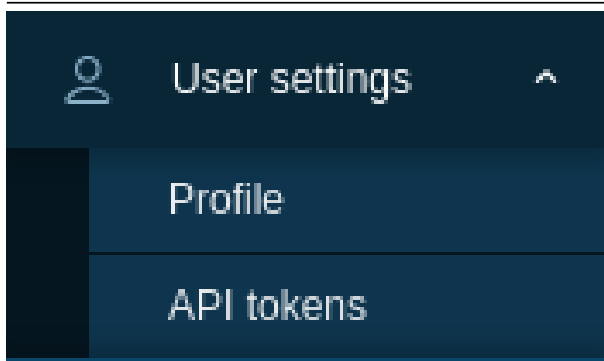

Third-level menu.

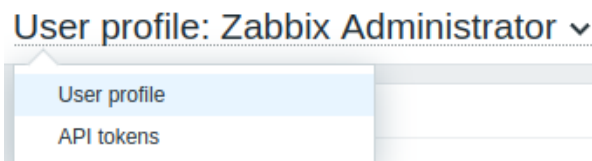

Title dropdown.

User profile

The **User profile** section provides options to set a custom interface language, color theme, number of rows displayed in the lists, etc. The changes made here will be applied to the current user only.

The **User** tab allows you to set various user preferences.

Parameter	Description
<i>Password</i>	Click on the <i>Change password</i> button to open three fields: <i>Old password</i> , <i>New password</i> , <i>New password (once again)</i> . On a successful password change, the user will be logged out of all active sessions.
<i>Language</i>	Note that the password can only be changed for users using Zabbix internal authentication . Select the interface language of your choice or select System default to use default system settings. Selecting <i>English (en_US)</i> will also enable the US time/date format in the frontend.
<i>Time zone</i>	For more information, see Installation of additional frontend languages . Select the time zone to override the global time zone on the user level or select System default to use global time zone settings.
<i>Theme</i>	Select a color theme specifically for your profile: System default - use default system settings; Blue - standard blue theme; Dark - alternative dark theme; High-contrast light - light theme with high contrast; High-contrast dark - dark theme with high contrast.

Parameter	Description
<i>Auto-login</i>	Mark this checkbox to make Zabbix remember you and log you in automatically for 30 days. Browser cookies are used for this.
<i>Auto-logout</i>	With this checkbox marked, you will be logged out automatically after the set amount of seconds (minimum 90 seconds, maximum 1 day). Time suffixes are supported, for example: 90s, 5m, 2h, 1d. Note that this option will not work in the following cases: * When the <i>Monitoring</i> menu pages perform background information refreshes. In case pages that are refreshing data in a specific time interval (dashboards, graphs, latest data, etc.) are left open, the session lifetime is extended, respectively disabling the auto-logout feature. * If logging in with the <i>Remember me for 30 days</i> option checked. <i>Auto-logout</i> can also accept "0", meaning that the auto-logout feature becomes disabled after profile settings update.
<i>Refresh</i>	Set how often the information on the <i>Monitoring</i> menu pages will be refreshed (minimum 0 seconds, maximum 1 hour). Time suffixes are supported, for example: 30s, 90s, 1m, 1h.
<i>Rows per page</i>	Set how many rows will be displayed per page in the lists. Fewer rows (and fewer records to display) result in faster loading times.
<i>URL (after login)</i>	Set a specific URL to be displayed after login. Instead of the default <i>Dashboards</i> , it can be, for example, the URL of <i>Monitoring</i> → <i>Triggers</i> .

The **Media** tab allows you to specify **media details** for the user, such as media types and addresses to use and when to use them to deliver notifications.

Media	Type	Send to	When active	Use if severity	Status	Action
	Email	example@zabbix.com	1-7,00:00-24:00	N I W A H D	Disabled	Edit Remove
	Gmail	example@gmail.com	1-7,00:00-24:00	N I W A H D	Enabled	Edit Remove

If the media type has been disabled:

- a yellow info icon is displayed after the name;
- "Disabled" is displayed in the *Status* column.

Note:

Only *Admin* and *Super admin* type **users** can change their own media details.

Note that for provisioned users:

- provisioned user media cannot be deleted;
- provisioned user media can be disabled/enabled;
- such provisioned user media fields as *When active*, *Use if severity* and *Enabled* can be manually edited;
- additional user media can be added (for example, additional email addresses) for provisioned users manually;
- manually added user media can be deleted.

The **Frontend notifications** tab allows you to set **global notifications**.

API tokens

The *API tokens* section allows you to view tokens assigned to the user, edit token details and **create new tokens**. This section is available to a user only if the *Manage API tokens* action is allowed in the **user role** settings.

Name	Expires at	Created at	Last accessed at	Status
Token 1	Never	2021-01-22 18:58:11	Never	Enabled
Token 2	2021-01-26 00:00:00	2021-01-22 16:13:03	Never	Enabled

You can filter API tokens by name, expiry date, or status (*Enabled/Disabled*). Click on the token status in the list to quickly enable/disable a token. You can also enable/disable multiple tokens at once by selecting them in the list and then clicking on the *Enable/Disable* buttons below the list.

Attention:

Users cannot view the *Auth token* value of the tokens assigned to them in Zabbix. The *Auth token* value is displayed only once - immediately after creating a token. If the token has been lost, it has to be regenerated.

1 Global notifications

Overview

Global notifications provide a way to display real-time issues directly on your current screen within Zabbix frontend.

Without global notifications, when working outside the *Problems* or *Dashboard* sections, you would not receive any information about current issues. Global notifications ensure that this information is displayed, regardless of your current location within the Zabbix frontend.

Global notifications include both **displaying a message** and **playing a sound**.

Attention:

The autoplay of sounds might be disabled (by default) in recent browser versions. In such cases, you need to enable this setting manually.

Configuration

Global notifications can be enabled per user in the **Frontend notifications** tab of **profile configuration**.

The screenshot shows the 'Frontend notifications' configuration page for a user. The page has three tabs: 'User', 'Media 1', and 'Frontend notifications', with the last one being active. The configuration includes:

- Frontend notifications:** A checked checkbox.
- Message timeout:** A text input field containing '60'.
- Play sound:** A dropdown menu set to 'Once'.
- Trigger severity:** A list of seven severity levels, each with a checked checkbox, a dropdown menu for the sound, and 'Play' and 'Stop' buttons:
 - Recovery: alarm_ok
 - Not classified: no_sound
 - Information: alarm_information
 - Warning: alarm_warning
 - Average: alarm_average
 - High: alarm_high
 - Disaster: alarm_disaster
- Show suppressed problems:** An unchecked checkbox.
- Buttons:** 'Update' and 'Cancel' buttons at the bottom.



Parameter	Description
<i>Frontend notifications</i>	Mark the checkbox to enable global notifications.
<i>Message timeout</i>	Set the duration for which the message will be displayed. By default, messages remain on the screen for 60 seconds. Time suffixes are supported, for example: 30s, 5m, 2h, 1d.
<i>Play sound</i>	Set the duration for which the sound will be played. Once - sound is played once and fully; 10 seconds - sound is repeated for 10 seconds; Message timeout - sound is repeated while the message is visible.
<i>Trigger severity</i>	Set the trigger severities for which global notifications and sounds will be activated. You can also select sounds appropriate for various severities. If no severity is marked, no messages will be displayed. Additionally, recovery messages will only be displayed for marked severities. For instance, if <i>Recovery</i> and <i>Disaster</i> are marked, global notifications will be displayed for problems and recoveries of <i>Disaster</i> severity triggers.
<i>Show suppressed problems</i>	Mark the checkbox to display notifications for problems that would otherwise be suppressed (not shown) due to host maintenance.

Global messages displayed

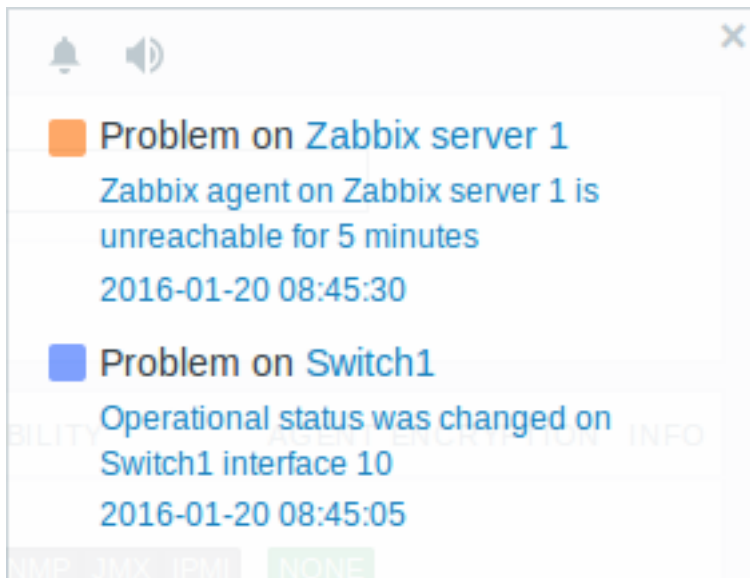
As messages arrive, they are displayed in a floating section on the right-hand side. You can freely reposition this section by dragging the section header.



For this section, several controls are available:



-  **Snooze** button silences the currently active alarm sound;
-  **Mute/Unmute** button switches between playing and not playing the alarm sounds at all.

2 Sound in browsers

Overview

Sound is used in [global notifications](#).

For the sounds to be played in Zabbix frontend, *Frontend notifications* must be enabled in the user profile's *Frontend notifications* tab, with all trigger severities checked. Additionally, sounds should be enabled in the global notification pop-up window.

If, for any reason, audio cannot be played on the device, the  button in the global notification pop-up window will remain permanently in the "mute" state, accompanied by the message "Cannot support notification audio for this device" upon hovering over the  button.

Sounds, including the default audio clips, are supported in MP3 format only.

The sounds of Zabbix frontend have been successfully tested in recent Firefox and Opera browsers on Linux, and in Chrome, Firefox, Microsoft Edge, and Opera browsers on Windows.

Attention:

The autoplay of sounds might be disabled (by default) in recent browser versions. In such cases, you need to enable this setting manually.

4 Global search

It is possible to search Zabbix frontend for hosts, host groups, templates and template groups.

The search input box is located below the Zabbix logo in the menu. The search can be started by pressing *Enter* or clicking on the

 search icon.



If there is a host that contains the entered string in any part of the name, a dropdown will appear, listing all such hosts (with the matching part highlighted in orange). The dropdown will also list a host if that host's visible name is a match to the technical name entered as a search string; the matching host will be listed, but without any highlighting.

Searchable attributes

Hosts can be searched by the following properties:

- Host name
- Visible name
- IP address
- DNS name

Templates can be searched by name or visible name. If you search by a name that is different from the visible name (of a template/host), in the search results it is displayed below the visible name in parentheses.

Host and template groups can be searched by name. Specifying a parent group implicitly selects all nested groups.

Search results

Search results consist of four separate blocks for hosts, host groups, templates and template groups.

Hosts												
Host	IP	DNS	Monitoring				Configuration					
Zabbix server	127.0.0.1		Latest data	Problems	Graphs	Dashboards	Web	Items 131	Triggers 71	Graphs 25	Discovery 5	Web
Displaying 1 of 1 found												
Host groups												
Host group	Monitoring				Configuration							
Zabbix servers			Latest data	Problems	Web	Hosts 1						
Displaying 1 of 1 found												
Templates												
Template	Configuration											
Remote Zabbix server health			Items 58	Triggers 42	Graphs 11	Dashboards 2	Discovery 2	Web				
Zabbix server health			Items 58	Triggers 42	Graphs 11	Dashboards 2	Discovery 2	Web				
Displaying 2 of 2 found												
Template groups												
Template group	Configuration											
No data found												

It is possible to collapse/expand each individual block. The entry count is displayed at the bottom of each block, for example, *Displaying 13 of 13 found*. If there are no entries, the entry count is not displayed. Total entries displayed within one block are limited to 100.

Each entry provides links to monitoring and configuration data. See the [full list](#) of links.

For all configuration data (such as items, triggers, graphs) the amount of entities found is displayed by a number next to the entity name, in gray. **Note** that if there are zero entities, no number is displayed.

Enabled hosts are displayed in blue, disabled hosts in red.

Links available

For each entry the following links are available:

- Hosts
 - Monitoring
 - * Latest data
 - * Problems
 - * Graphs
 - * Host dashboards
 - * Web scenarios
 - Configuration
 - * Items
 - * Triggers
 - * Graphs
 - * Discovery rules
 - * Web scenarios
- Host groups
 - Monitoring
 - * Latest data
 - * Problems
 - * Web scenarios
 - Configuration
 - * Hosts
- Templates
 - Configuration
 - * Items
 - * Triggers
 - * Graphs
 - * Template dashboards
 - * Discovery rules
 - * Web scenarios
- Template groups
 - Configuration
 - * Templates

5 Frontend maintenance mode

Overview

It is possible to temporarily disable Zabbix frontend to restrict access. This is useful for protecting Zabbix database from user-initiated changes, preserving its integrity.

While Zabbix frontend is in maintenance mode, you can safely stop the database and perform maintenance tasks.

Users from defined IP addresses will be able to interact with the frontend normally during maintenance mode.

Configuration

To enable maintenance mode, open the `maintenance.inc.php` file (located in `/conf` of the Zabbix HTML document directory on the web server) and uncomment the following lines:

```
// Maintenance mode.
define('ZBX_DENY_GUI_ACCESS', 1);

// Array of IP addresses, which are allowed to connect to frontend (optional).
$ZBX_GUI_ACCESS_IP_RANGE = array('127.0.0.1');

// Message shown on warning screen (optional).
$ZBX_GUI_ACCESS_MESSAGE = 'We are upgrading MySQL database till 15:00. Stay tuned...';
```

Note:

In most cases, the `maintenance.inc.php` file is located in `/conf` of the Zabbix HTML document directory on the web server. However, some operating systems and web servers may use a different location.

For example, the location for:

- SUSE and RedHat is `/etc/zabbix/web/maintenance.inc.php`.
- Debian-based systems is `/usr/share/zabbix/conf/`.

See also [Copying PHP files](#).

Parameter	Details
ZBX_DENY_GUI_ACCESS	If defined with any value, maintenance mode will be enabled. To disable maintenance mode, comment out or delete.
ZBX_GUI_ACCESS_IP_RANGE	Array of IP addresses, which are allowed to connect to the frontend (optional). For example: <code>array('192.168.1.1', '192.168.1.2')</code>
ZBX_GUI_ACCESS_MESSAGE	Message to inform users about the maintenance (optional). If undefined, the default message <i>'Zabbix is under maintenance'</i> will be used.

Display

Users will see the following screen when trying to access Zabbix frontend while in maintenance mode. The screen is refreshed every 30 seconds in order to return to a normal state without user intervention when the maintenance is over.

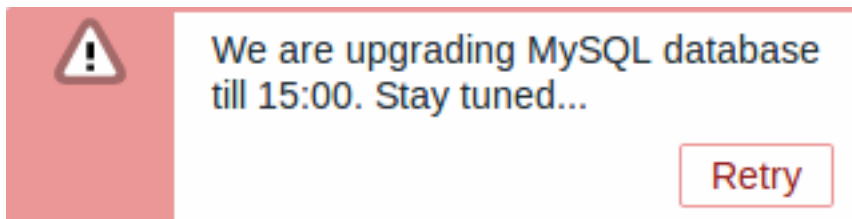

IP addresses defined in `ZBX_GUI_ACCESS_IP_RANGE` will be able to access the frontend as usual.

6 Page parameters

Overview

Most Zabbix web interface pages support various HTTP GET parameters that control what will be displayed. They may be passed by specifying parameter=value pairs after the URL, separated from the URL by a question mark (?) and from each other by ampersands (&).

Monitoring > Problems

The following parameters are supported:

Parameter	Description	Example
<i>show</i>	Filter option <i>Show</i> . Possible values: 1 - recent problems; 2 - all; 3 - in problem state.	show=1
<i>name</i>	Filter option <i>Problem</i> : freeform string.	name=Zabbix agent
<i>severities</i>	Filter option <i>Severity</i> : array of selected severities in the format <i>severities[*]=*</i> (replace * with severity level). Possible values: 0 - not classified; 1 - information; 2 - warning; 3 - average; 4 - high; 5 - disaster.	severities[3]=3
<i>inventory evaltype</i>	Filter option <i>Host inventory</i> : array of inventory fields [field], [value] Filter option <i>Tags</i> , tag filtering strategy. Possible values: 0 - and/or; 2 - or.	inventory[0][field]=type&inventory[0][value]=value&evaltype=0
<i>tags</i>	Filter option <i>Tags</i> : array of defined tags [tag], [operator], [value] Possible operator values: 0 - contains; 1 - equals; 2 - does not contain; 3 - does not equal; 4 - exists; 5 - does not exist.	tags[0][tag]=target&tags[0][operator]=&tags[0][value]=value
<i>show_tags</i>	Filter option <i>Show tags</i> . Possible values: 0 - none; 1 - one; 2 - two; 3 - three.	show_tags=3
<i>tag_name_format</i>	Filter option <i>Tag name</i> . Possible values: 0 - full name; 1 - shortened name; 2 - none.	tag_name_format=1
<i>tag_priority</i>	Filter option <i>Tag display priority</i> : comma-separated string of tag display priority	tag_priority=customer, target
<i>show_suppressed</i>	Filter option <i>Show suppressed problems</i> . Possible values: 1 - show; 2 - do not show.	show_suppressed=1

Parameter	Description	Example
<i>acknowledgement_status</i>	Filter option <i>Acknowledgement status</i> . Possible values: 0 - all; 1 - unacknowledged; 2 - acknowledged.	acknowledgement_status=0
<i>acknowledged_by_me</i>	Filter option <i>By me</i> ; supported only with <i>acknowledgement_status</i> =2. Possible values: 0 - disabled; 1 - enabled.	acknowledged_by_me=1
<i>compact_view</i>	Filter option <i>Compact view</i> . Possible values: 0 - disabled; 1 - enabled.	compact_view=1
<i>highlight_row</i>	Filter option <i>Highlight whole row</i> ; supported only with <i>compact_view</i> =1. Possible values: 0 - disabled; 1 - enabled.	highlight_row=1
<i>filter_name</i>	Filter properties option <i>Name</i> : freeform string	filter_name=Databases
<i>filter_show_counter</i>	Filter properties option <i>Show number of records</i> . Possible values: 0 - disabled; 1 - enabled.	filter_show_counter=1
<i>filter_custom_time</i>	Filter properties option <i>Set custom time period</i> . Possible values: 0 - disabled; 1 - enabled.	filter_custom_time=1
<i>sort</i>	Column to sort by. Possible values: 0 - disabled; 1 - enabled.	sort=clock
<i>sortorder</i>	Sort order of results. Possible values: clock - sort by <i>Time</i> column; host - sort by <i>Host</i> column; severity - sort by <i>Severity</i> column; name - sort by <i>Problem</i> column.	sortorder=DESC
<i>age_state</i>	Filter option <i>Age less than</i> ; supported only with <i>show</i> =3. Possible values: DESC - descending; ASC - ascending.	age_state=1
<i>age</i>	Filter option <i>Age less than</i> : integer, number of days; supported only with <i>age_state</i> =1 and <i>show</i> =3. Possible values: 0 - disable age parameter; 1 - enable age parameter.	age=7
<i>groupids</i>	Filter option <i>Host groups</i> : array of host group IDs.	groupids[]=4
<i>hostids</i>	Filter option <i>Hosts</i> : array of host IDs	hostids[]=10084
<i>triggerids</i>	Filter option <i>Triggers</i> : array of trigger IDs	triggerids[]=22382
<i>show_timeline</i>	Filter option <i>Show timeline</i> ; not supported with <i>compact_view</i> =1. Possible values: 0 - do not show; 1 - show.	show_timeline=1

Parameter	Description	Example
<i>details</i>	Filter option <i>Show details</i> .	details=1
	Possible values: 0 - do not show; 1 - show.	
<i>from</i>	Date range start, can be relative (e.g., now-1m); supported only with filter_custom_time=1	from=now-2h
<i>to</i>	Date range end, can be relative (e.g., now-1m); supported only with filter_custom_time=1	to=now

See also: Problems page [filter options](#).

Kiosk mode

The kiosk mode in supported frontend pages can be activated using URL parameters. For example, in dashboards:

- /zabbix.php?action=dashboard.view&kiosk=1 - activate kiosk mode
- /zabbix.php?action=dashboard.view&kiosk=0 - activate normal mode

Slideshow

It is possible to activate a slideshow in the dashboard:

- /zabbix.php?action=dashboard.view&slideshow=1 - activate slideshow

7 Definitions

Overview

While many things in the frontend can be configured using the frontend itself, some customizations are currently only possible by editing a definitions file.

This file is defines.inc.php located in /include of the Zabbix HTML document directory.

Parameters

Parameters in this file that could be of interest to users:

- ZBX_MIN_PERIOD

Minimum graph period, in seconds. One minute by default.

- GRAPH_YAXIS_SIDE_DEFAULT

Default location of Y axis in simple graphs and default value for drop down box when adding items to custom graphs. Possible values: 0 - left, 1 - right.

Default: 0

- ZBX_SESSION_NAME

String used as the name of the Zabbix frontend session cookie.

Default: zbx_sessionid

- ZBX_DATA_CACHE_TTL

TTL timeout in seconds used to invalidate data cache of **Vault response**. Set 0 to disable Vault response caching.

Default: 60

- SUBFILTER_VALUES_PER_GROUP

Number of subfilter values per group (For example, in the **latest data** subfilter).

Default: 1000

- ZBX_MAX_WIDGET_LINES

Maximum number of widget lines to display.

Default: 1000

8 Creating your own theme

Overview

By default, Zabbix provides a number of predefined themes. You may follow the step-by-step procedure provided here in order to create your own. Feel free to share the result of your work with Zabbix community if you created something nice.

Step 1

To define your own theme you'll need to create a CSS file and save it in the `assets/styles/` folder (for example, `custom-theme.css`). You can either copy the files from a different theme and create your theme based on it or start from scratch.

Step 2

Add your theme to the list of themes returned by the `APP::getThemes()` method. You can do this by overriding the `ZBase::getThemes()` method in the `APP` class. This can be done by adding the following code before the closing brace in `include/classes/core/APP.php`:

```
public static function getThemes() {
    return array_merge(parent::getThemes(), [
        'custom-theme' => _('Custom theme')
    ]);
}
```

Attention:

Note that the name you specify within the first pair of quotes must match the name of the theme file without extension.

To add multiple themes, just list them under the first theme, for example:

```
public static function getThemes() {
    return array_merge(parent::getThemes(), [
        'custom-theme' => _('Custom theme'),
        'anothertheme' => _('Another theme'),
        'onemoretheme' => _('One more theme')
    ]);
}
```

Note that every theme except the last one must have a trailing comma.

Note:

To change graph colors, the entry must be added in the `graph_theme` database table.

Step 3

Activate the new theme.

In Zabbix frontend, you may either set this theme to be the default one or change your theme in the user profile.

Enjoy the new look and feel!

9 Debug mode

Overview

Debug mode may be used to diagnose performance problems with frontend pages.

Configuration

Debug mode can be activated for individual users who belong to a user group:

- when configuring a **user group**;
- when viewing configured **user groups**.

When *Debug mode* is enabled for a user group, its users will see a *Debug* button in the lower right corner of the browser window:

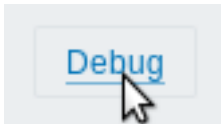

Clicking on the *Debug* button opens a new window below the page contents which contains the SQL statistics of the page, along with a list of API calls and individual SQL statements:

```

***** Script profiler *****
Total time: 0.249825
Total SQL time: 0.139814
SQL count: 143 (selects: 117 | executes: 26)
Peak memory usage: 6M
Memory limit: 128M

1. hostgroup.get [latest.php:124]

Parameters:          Result:
Array                Array
(                   (
    [output] => Array    [4] => Array
        (               (
            [0] => groupid    [groupid] => 4
        )
    )
)
  
```

Hide debug

In case of performance problems with the page, this window may be used to search for the root cause of the problem.

Warning:
Enabled *Debug mode* negatively affects frontend performance.

10 Cookies used by Zabbix

Overview

This page provides a list of cookies used by Zabbix.

Name	Description	Values	Expires/Max-Age	HttpOnly ¹	Secure ²
ZBX_SESSIONID	Zabbix frontend session data, stored as JSON encoded by base64		Session (expires when the browsing session ends)	+	+ (only if HTTPS is enabled on a web server)
tab	Active tab number; this cookie is only used on pages with multiple tabs (e.g. <i>Host</i> , <i>Trigger</i> or <i>Action</i> configuration page) and is created, when a user navigates from a primary tab to another tab (such as <i>Tags</i> or <i>Dependencies</i> tab). 0 is used for the primary tab.	Example: 1	Session (expires when the browsing session ends)	-	-
browserwarning	Whether a warning about using an outdated browser should be ignored.	yes	Session (expires when the browsing session ends)	-	-
system-message-ok	A message to show as soon as page is reloaded.	Plain text message	Session (expires when the browsing session ends) or as soon as page is reloaded	+	-
system-message-error	An error message to show as soon as page is reloaded.	Plain text message	Session (expires when the browsing session ends) or as soon as page is reloaded	+	-

Note:

Forcing 'HttpOnly' flag on Zabbix cookies by a webserver directive is not supported.

Footnotes

¹ When `HttpOnly` is 'true' the cookie will be made accessible only through the HTTP protocol. This means that the cookie won't be accessible by scripting languages, such as JavaScript. This setting can effectively help to reduce identity theft through XSS attacks (although it is not supported by all browsers).

² `Secure` indicates that the cookie should only be transmitted over a secure HTTPS connection from the client. When set to 'true', the cookie will only be set if a secure connection exists.

11 Time zones

Overview

The frontend time zone can be set globally in the frontend and adjusted for individual users.

The screenshot shows a user settings interface with several configuration options on the left and a dropdown menu for 'Default time zone' on the right. The dropdown menu is open, showing a list of time zones. The selected option is 'System: (UTC+02:00) Europe/Riga'. Other visible options include '(UTC-01:00) America/Scoresbysund', '(UTC-01:00) Atlantic/Azores', '(UTC-01:00) Atlantic/Cape_Verde', '(UTC-02:00) America/Noronha', '(UTC-02:00) Atlantic/South_Georgia', '(UTC-03:00) America/Araguaina', '(UTC-03:00) America/Argentina/Buenos_Aires', '(UTC-03:00) America/Argentina/Catamarca', '(UTC-03:00) America/Argentina/Cordoba', and '(UTC-03:00) America/Argentina/Jujuy'.

If `System` is selected, the web server time zone will be used for the frontend (including the value of 'date.timezone' of `php.ini`, if set), while Zabbix server will use the time zone of the machine it is running on.

Note:

Zabbix server will only use the specified global/user time zone when expanding macros in notifications (e.g. `{EVENT.TIME}` can expand to a different time zone per user) and for the time limit when notifications are sent (see "When active" setting in user [media configuration](#)).

The choice of time zone does not affect the frontend time/date format. Instead, you may adjust the interface language (either at installation or under [user settings](#)) - selecting `English (en_US)` will also enable the US time/date format in the frontend.

Configuration

The global time zone:

- can be set manually when [installing](#) the frontend
- can be modified in *Administration* → *General* → *GUI*

User-level time zone:

- can be set when [configuring/updating](#) a user

- can be set by each user in their [user profile](#)

See also: Aligning time zones when using [scheduling intervals](#).

12 Resetting password

Overview This section describes the steps for resetting user passwords in Zabbix.

Steps Turn to your Zabbix administrator if you have forgotten your Zabbix password and cannot log in.

A Super administrator user can change passwords for all users in the [user configuration form](#).

If a Super administrator has forgotten their password and cannot log in, the following SQL query must be run to apply the default password to the Super admin user (replace 'Admin' with the appropriate Super admin username):

```
UPDATE users SET passwd = '$2a$10$ZXIvHAEP2ZM.dLXTm6uPHOMV1ARXX7cqjbbM6Fn0cANzkCQBWpMrS' WHERE username =
```

After running this query, the user password will be set to *zabbix*. Make sure to change the default password on the first login.

13 Time period selector

Overview

The *Time period* selector allows to select often required periods with one mouse click. It can be expanded or collapsed by clicking the *Time period* tab in the top right corner.

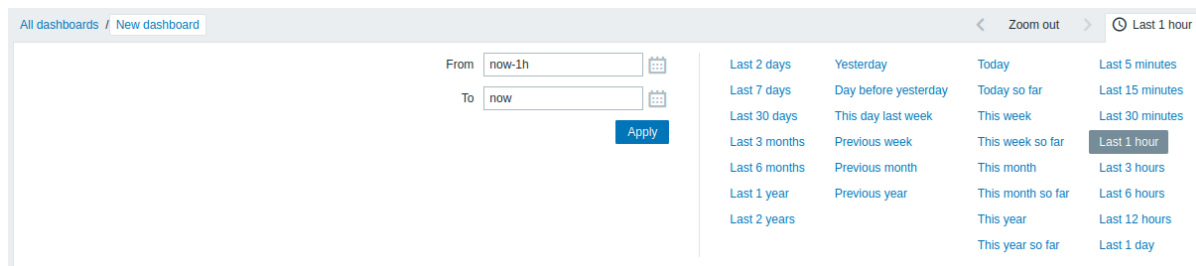

Options such as *Today*, *This week*, etc., display the whole period, including the hours/days in the future. Options such as *Today so far*, *This week so far*, etc., display only the hours passed.

Once a period is selected, it can be moved back and forth in time by clicking the arrow buttons. The *Zoom out* button allows to zoom out the period by 50% in each direction.

Note:

For [graphs](#), selecting the displayed time period is also possible by highlighting an area in the graph with the left mouse button. Once you release the left mouse button, the graph will zoom into the highlighted area. Zooming out is also possible by double-clicking in the graph.

The *From/To* fields display the selected period in either absolute time syntax (in format `Y-m-d H:i:s`) or relative time syntax. A relative time period can contain one or several mathematical operations (- or +), for example, `now-1d` or `now-1d-2h+5m`.

The following relative time abbreviations are supported:

- `now`
- `s` (seconds)
- `m` (minutes)
- `h` (hours)
- `d` (days)
- `w` (weeks)
- `M` (months)
- `y` (years)

Precision is supported in the *Time period* selector (for example, `/M` in `now-1d/M`). Details of precision:

Precision	From	To
m	Y-m-d H:m:00	Y-m-d H:m:59
h	Y-m-d H:00:00	Y-m-d H:59:59
d	Y-m-d 00:00:00	Y-m-d 23:59:59
w	Monday of the week 00:00:00	Sunday of the week 23:59:59
M	First day of the month 00:00:00	Last day of the month 23:59:59
y	1st of January of the year 00:00:00	31st of December of the year 23:59:59

It is also possible to select a time period using the *Date picker*. To open it, click the calendar icon next to the *From/To* fields.

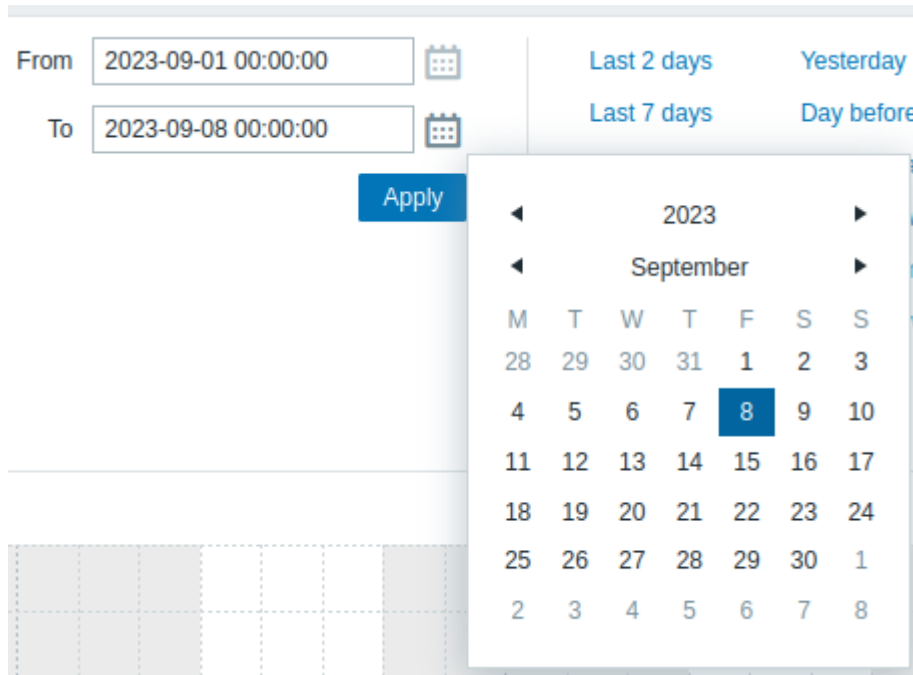

Note: Within the date picker, you can navigate between year/month/date using Tab, Shift+Tab, and keyboard arrow buttons. Pressing Enter confirms the selection.

Examples

From	To	Selected period
now/d	now/d	00:00 - 23:59 today
now/d	now/d+1d	00:00 today - 23:59 tomorrow
now/w	now/w	Monday 00:00:00 - Sunday 23:59:59 this week
now-1y/w	now-1y/w	The week of Monday 00:00:00 - Sunday 23:59:59 one year ago

19 Best practices

Overview This section outlines best practices for setting up Zabbix.

While these practices are not mandatory for Zabbix to operate, implementing them is highly recommended for optimal and secure usage experience.

1 Security best practices

Overview

This section contains best practices for setting up Zabbix in a secure way.

The practices in this section are not required for the functioning of Zabbix but are recommended for better system security.

UTF-8 encoding

UTF-8 is the only encoding supported by Zabbix. It is known to work without any security flaws. Users should be aware that there are known security issues if using some of the other encodings.

Windows installer paths

When using Windows installers, it is recommended to use the default paths provided by the installer. Using custom paths without proper permissions could compromise the security of the installation.

Zabbix Security Advisories and CVE database

See [Zabbix Security Advisories and CVE database](#).

1 Access control

Overview

This section contains best practices for setting up access control in a secure way.

Principle of least privilege

User accounts, at all times, should run with as few privileges as possible. This means that user accounts in Zabbix frontend, database users, or the user for Zabbix server/proxy/agent processes should only have the privileges that are essential for performing the intended functions.

Attention:

Giving extra privileges to the 'zabbix' user will allow it to access configuration files and execute operations that can compromise the infrastructure security.

When configuring user account privileges, Zabbix **frontend user types** should be considered. Note that although the *Admin* user type has fewer privileges than the *Super Admin* user type, it can still manage configuration and execute custom scripts.

Note:

Some information is available even for non-privileged users. For example, while *Alerts* → *Scripts* is available only for *Super Admin* users, scripts can also be retrieved through Zabbix API. In this case, limiting script permissions and excluding sensitive information from scripts (for example, access credentials) can help avoid exposing sensitive information available in global scripts.

Secure user for Zabbix agent

By default, Zabbix server and Zabbix agent processes share one 'zabbix' user. To ensure that Zabbix agent cannot access sensitive details in the server configuration (for example, database login information), the agent should be run as a different user:

1. Create a secure user.
2. Specify this user in the agent configuration file **User** parameter.
3. Restart the agent with administrator privileges. Privileges will be dropped to the specified user.

Revoke write access to SSL configuration file in Windows

Zabbix Windows agent compiled with OpenSSL will try to reach the SSL configuration file in `c:\openssl-64bit`. The `openssl-64bit` directory on disk C: can be created by non-privileged users.

To improve security, create this directory manually and revoke write access from non-admin users.

Please note that directory names will differ on 32-bit and 64-bit versions of Windows.

Hardening security of Zabbix components

Some functionality can be switched off to harden the security of Zabbix components:

- global script execution on Zabbix server can be disabled by setting `EnableGlobalScripts=0` in server configuration;
- global script execution on Zabbix proxy is disabled by default (can be enabled by setting `EnableRemoteCommands=1` in proxy configuration);
- global script execution on Zabbix agents is disabled by default (can be enabled by adding an `AllowKey=system.run[<command>,*]` parameter for each allowed command in agent configuration);
- user HTTP authentication can be disabled by setting `$ALLOW_HTTP_AUTH=false` in the frontend configuration file (`zabbix.conf.php`). Note that reinstalling the frontend (running `setup.php`) will remove this parameter.

1 Securing MySQL/MariaDB

Overview

This section contains best practices for securing a MySQL/MariaDB database.

Note:

For a basic setup, see the default [MySQL/MariaDB database creation](#) instructions, which include creating the 'zabbix' user with full privileges on the Zabbix database. This user is the database owner that also has the necessary privileges for modifying the database structure when [upgrading](#) Zabbix.

To improve security, creating additional database roles and users with minimal privileges is recommended. These roles and users should be configured based on the [principle of least privilege](#), that is, they should only have privileges that are essential for performing the intended functions.

Creating user roles

Create the following roles with the corresponding privileges:

- **zbx_srv** - role for running Zabbix server and proxy:

```
CREATE ROLE 'zbx_srv';
GRANT DELETE, INSERT, SELECT, UPDATE ON zabbix.* TO 'zbx_srv';
FLUSH PRIVILEGES;
```

- **zbx_web** - role for running Zabbix frontend and API:

```
CREATE ROLE 'zbx_web';
GRANT DELETE, INSERT, SELECT, UPDATE ON zabbix.* TO 'zbx_web';
FLUSH PRIVILEGES;
```

- **zbx_bckp** - role for table backup:

```
CREATE ROLE 'zbx_bckp';
GRANT LOCK TABLES, TRIGGER, SELECT ON zabbix.* TO 'zbx_bckp';
GRANT process ON *.* TO 'zbx_bckp';
FLUSH PRIVILEGES;
```

Note:

Table restoration and upgrade should be performed by the database owner.

- **zbx_part** - role with a reduced set of privileges for database partitioning; note that this role can be created only after the database has been created, as it grants privileges on specific database tables:

```
CREATE ROLE 'zbx_part';
GRANT SELECT, ALTER, DROP ON zabbix.history TO 'zbx_part';
GRANT SELECT, ALTER, DROP ON zabbix.history_uint TO 'zbx_part';
GRANT SELECT, ALTER, DROP ON zabbix.history_str TO 'zbx_part';
GRANT SELECT, ALTER, DROP ON zabbix.history_text TO 'zbx_part';
GRANT SELECT, ALTER, DROP ON zabbix.history_log TO 'zbx_part';
GRANT SELECT, ALTER, DROP ON zabbix.trends TO 'zbx_part';
GRANT SELECT, ALTER, DROP ON zabbix.trends_uint TO 'zbx_part';
-- For MariaDB: skip the next line (GRANT session_variables_admin ON *.* TO 'zbx_part');
GRANT session_variables_admin ON *.* TO 'zbx_part';
GRANT SELECT ON zabbix.dbversion TO 'zbx_part';
GRANT SELECT, DELETE ON zabbix.housekeeper TO 'zbx_part';
FLUSH PRIVILEGES;
```

After creating roles, they can be assigned to users.

Assigning user roles

To assign the created user roles, create users and assign the relevant roles to them. Replace <user>, <host>, <role>, and <password> as necessary.

```
CREATE USER '<user>'@'<host>' IDENTIFIED BY '<password>';
GRANT '<role>' TO '<user>'@'<host>';
SET DEFAULT ROLE '<role>' TO '<user>'@'<host>';
```

```
-- For MariaDB: SET DEFAULT ROLE '<role>' FOR '<user>'@'<host>'
FLUSH PRIVILEGES;
```

For example, to create and assign the role for running Zabbix server and proxy:

```
CREATE USER 'usr_srv'@'localhost' IDENTIFIED BY 'password';
GRANT 'zbx_srv' TO 'usr_srv'@'localhost';
SET DEFAULT ROLE ALL TO 'usr_srv'@'localhost';
FLUSH PRIVILEGES;
```

2 Securing PostgreSQL/TimescaleDB

Overview

This section contains best practices for securing a PostgreSQL database.

Note:

For a basic setup, see the default [PostgreSQL database creation](#) instructions, which include creating the 'zabbix' user with full privileges on the Zabbix database. This user is the database owner that also has the necessary privileges for modifying the database structure when [upgrading Zabbix](#).

To improve security, configuring a secure schema usage pattern, as well as creating additional database roles and users with minimal privileges is recommended. These roles and users should be configured based on the [principle of least privilege](#), that is, they should only have privileges that are essential for performing the intended functions.

Database setup

Create the user that will be the database owner, and create the Zabbix database; the database owner is the user that is specified on database creation:

```
createuser -U postgres -h localhost --pwprompt usr_owner
createdb -U postgres -h localhost -O usr_owner -E Unicode -T template0 zabbix
```

Note:

A clean install or upgrade of the database has to be performed by the database owner. This is because the right to drop a database object or alter its definition is a privilege that is inherent to the database owner and cannot be granted or revoked.

Attention:

The following commands on this page must be executed while the connection to PostgreSQL is made specifically to the zabbix database.

Create the zabbix schema and set the database owner (usr_owner) to be the owner of this schema:

```
CREATE SCHEMA zabbix AUTHORIZATION usr_owner;
```

Configure a secure schema [usage pattern](#):

```
REVOKE CREATE ON SCHEMA public FROM PUBLIC;
REVOKE ALL ON DATABASE zabbix FROM PUBLIC;
-- Note: search_path should point to the "zabbix" schema:
ALTER ROLE ALL IN DATABASE zabbix SET search_path = "zabbix";
```

After setting up the database, proceed to creating user roles.

Creating user roles

Create the following roles with the corresponding privileges:

- **zbx_srv** - role for running Zabbix server and proxy:

```
CREATE ROLE zbx_srv;
GRANT CONNECT ON DATABASE zabbix TO zbx_srv;
GRANT USAGE ON SCHEMA zabbix TO zbx_srv;
ALTER DEFAULT PRIVILEGES FOR ROLE usr_owner IN SCHEMA zabbix GRANT DELETE, INSERT, SELECT, UPDATE ON TABLES;
ALTER DEFAULT PRIVILEGES FOR ROLE usr_owner IN SCHEMA zabbix GRANT SELECT, UPDATE, USAGE ON SEQUENCES TO zbx_srv;
```

- **zbx_web** - role for running Zabbix frontend and API:

```
CREATE ROLE zbx_web;
GRANT CONNECT ON DATABASE zabbix TO zbx_web;
GRANT USAGE ON SCHEMA zabbix TO zbx_web;
ALTER DEFAULT PRIVILEGES FOR ROLE usr_owner IN SCHEMA zabbix GRANT DELETE, INSERT, SELECT, UPDATE ON TABLES TO zbx_web;
ALTER DEFAULT PRIVILEGES FOR ROLE usr_owner IN SCHEMA zabbix GRANT SELECT, UPDATE, USAGE ON SEQUENCES TO zbx_web;
```

- **zbx_bckp** - role for table backup:

```
CREATE ROLE zbx_bckp;
GRANT CONNECT ON DATABASE zabbix TO zbx_bckp;
GRANT USAGE ON SCHEMA zabbix TO zbx_bckp;
ALTER DEFAULT PRIVILEGES FOR ROLE usr_owner IN SCHEMA zabbix GRANT SELECT ON TABLES TO zbx_bckp;
ALTER DEFAULT PRIVILEGES FOR ROLE usr_owner IN SCHEMA zabbix GRANT SELECT, UPDATE, USAGE ON SEQUENCES TO zbx_bckp;
```

Note:
Table restoration is possible only by the database owner.

After creating roles, they can be assigned to users.

Assigning user roles

To assign the created user roles, create users and assign the relevant roles to them. Replace <user>, <role>, and <password> as necessary.

```
CREATE USER <user> WITH ENCRYPTED password '<password>';
GRANT <role> TO <user>;
```

For example, to create and assign the role for running Zabbix server and proxy:

```
CREATE USER usr_srv WITH ENCRYPTED password 'password';
GRANT zbx_srv TO usr_srv;
```

Database partitioning with TimescaleDB

Database partitioning is facilitated by TimescaleDB. To utilize TimescaleDB, Zabbix server requires database owner privileges.

If the PostgreSQL zabbix schema has already been created in the zabbix database, you can enable TimescaleDB with the following command:

```
echo "CREATE EXTENSION IF NOT EXISTS timescaledb WITH SCHEMA zabbix CASCADE;" | sudo -u postgres psql zabbix
```

2 Cryptography

Overview

This section contains best practices for setting up cryptography in a secure way.

Setting up SSL for Zabbix frontend

On RHEL-based systems, install the mod_ssl package:

```
dnf install mod_ssl
```

Create a directory for SSL keys:

```
mkdir -p /etc/httpd/ssl/private
chmod 700 /etc/httpd/ssl/private
```

Create the SSL certificate:

```
openssl req -x509 -nodes -days 365 -newkey rsa:2048 -keyout /etc/httpd/ssl/private/apache-selfsigned.key -out /etc/httpd/ssl/private/apache-selfsigned.crt
```

Fill out the prompts appropriately. The most important line is the one that requests the Common Name. You must enter the domain name you want to be associated with your server. You can enter the public IP address instead if you do not have a domain name.

```
Country Name (2 letter code) [XX]:
State or Province Name (full name) []:
Locality Name (eg, city) [Default City]:
Organization Name (eg, company) [Default Company Ltd]:
```

```
Organizational Unit Name (eg, section) []:  
Common Name (eg, your name or your server's hostname) []:example.com  
Email Address []:
```

Edit the Apache SSL configuration file (/etc/httpd/conf.d/ssl.conf):

```
DocumentRoot "/usr/share/zabbix"  
ServerName example.com:443  
SSLCertificateFile /etc/httpd/ssl/apache-selfsigned.crt  
SSLCertificateKeyFile /etc/httpd/ssl/private/apache-selfsigned.key
```

Restart the Apache service to apply the changes:

```
systemctl restart httpd.service
```

3 Web server

Overview

This section contains best practices for setting up the web server in a secure way.

Enabling Zabbix on root directory of URL

On RHEL-based systems, add a virtual host to Apache configuration (/etc/httpd/conf/httpd.conf) and set a permanent redirect for document root to Zabbix SSL URL. Note that `example.com` should be replaced with the actual name of the server.

Add lines:

```
<VirtualHost *:*>  
    ServerName example.com  
    Redirect permanent / https://example.com  
</VirtualHost>
```

Restart the Apache service to apply the changes:

```
systemctl restart httpd.service
```

Enabling HTTP Strict Transport Security (HSTS) on the web server

To protect Zabbix frontend against protocol downgrade attacks, we recommend enabling the [HSTS](#) policy on the web server.

To enable the HSTS policy for your Zabbix frontend in Apache configuration, follow these steps:

1. Locate your virtual host's configuration file:

- /etc/httpd/conf/httpd.conf on RHEL-based systems
- /etc/apache2/sites-available/000-default.conf on Debian/Ubuntu

2. Add the following directive to your virtual host's configuration file:

```
<VirtualHost *:*>  
    Header set Strict-Transport-Security "max-age=31536000"  
</VirtualHost>
```

3. Restart the Apache service to apply the changes:

On RHEL-based systems:

```
systemctl restart httpd.service
```

On Debian/Ubuntu

```
systemctl restart apache2.service
```

Enabling Content Security Policy (CSP) on the web server

To protect Zabbix frontend against Cross Site Scripting (XSS), data injection, and similar attacks, we recommend enabling Content Security Policy on the web server. To do so, configure the web server to return the [HTTP header](#).

Attention:

The following CSP header configuration is only for the default Zabbix frontend installation and for cases when all content originates from the site's domain (excluding subdomains). A different CSP header configuration may be required if you are, for example, configuring the *URL* widget to display content from the site's subdomains or external domains, switching from *OpenStreetMap* to another map engine, or adding external CSS or widgets. If you're using the Duo Universal Prompt **multi-factor authentication** method, make sure to add "duo.com" to the CSP directive in your virtual host's configuration file.

To enable CSP for your Zabbix frontend in Apache configuration, follow these steps:

1. Locate your virtual host's configuration file:

- /etc/httpd/conf/httpd.conf on RHEL-based systems
- /etc/apache2/sites-available/000-default.conf on Debian/Ubuntu

2. Add the following directive to your virtual host's configuration file:

```
<VirtualHost *:*>
    Header set Content-Security-Policy: "default-src 'self' *.openstreetmap.org; script-src 'self' 'unsafe-
```

3. Restart the Apache service to apply the changes:

```
#### On RHEL-based systems:
systemctl restart httpd.service
```

```
#### On Debian/Ubuntu
systemctl restart apache2.service
```

Disabling web server information exposure

To improve security, disabling all web server signatures is recommended.

By default, the web server is exposing the software signature:

```
▼ Response Headers    view source
Cache-Control: no-store, no-cache, must-revalidate
Connection: Keep-Alive
Content-Encoding: gzip
Content-Length: 1160
Content-Type: text/html; charset=UTF-8
Keep-Alive: timeout=5, max=100
Pragma: no-cache
Server: Apache/2.4.18 (Ubuntu)
```

The signature can be disabled by adding the following parameters to the Apache configuration file:

```
ServerSignature Off
ServerTokens Prod
```

PHP signature (X-Powered-By HTTP header) can be disabled by changing the `php.ini` configuration file (by default, the signature is disabled):

```
expose_php = Off
```

Web server restart is required for configuration file changes to be applied.

For additional security, you can use the `mod_security` tool with Apache (package `libapache2-mod-security2`). This tool allows removing the server signature instead of removing only the version from the server signature. The server signature can be changed to any value by setting "SecServerSignature" to any desired value after installing `mod_security`.

Please refer to the documentation of your web server to find help on how to remove/change software signatures.

Disabling web server default error pages

To avoid information exposure, disabling the default error pages is recommended.

By default, a web server uses built-in error pages:

Not Found

The requested URL `/custom-text` was not found on this server.

Apache/2.4.18 (Ubuntu) Server at localhost Port 80

These default error pages should be replaced/removed. For example, the "ErrorDocument" directive can be used to define a custom error page/text for the Apache web server.

Please refer to the documentation of your web server to find help on how to replace/remove default error pages.

Removing web server test page

To avoid information exposure, removing the web server test page is recommended.

By default, the Apache web server webroot contains the `index.html` test page:

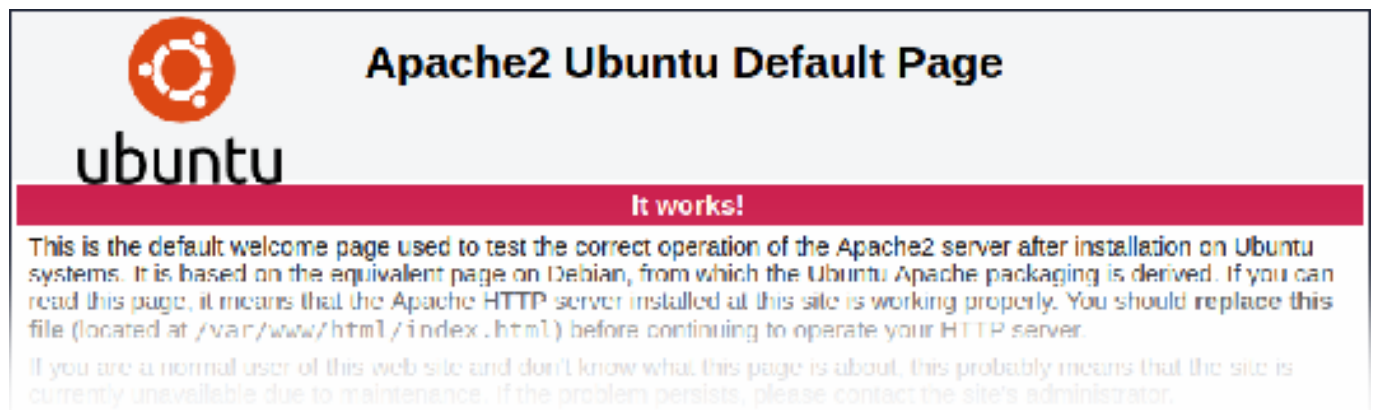

Please refer to the documentation of your web server to find help on how to remove default test pages.

Set X-Frame-Options HTTP response header

By default, Zabbix is configured with the *Use X-Frame-Options HTTP header* parameter set to `SAMEORIGIN`. This means that content can only be loaded in a frame that has the same origin as the page itself.

Zabbix frontend elements that pull content from external URLs (namely, the URL `dashboard widget`) display retrieved content in a sandbox with all sandboxing restrictions enabled.

These settings enhance the security of the Zabbix frontend and provide protection against XSS and clickjacking attacks. *Super admin* users can *modify* the *Use iframe sandboxing* and *Use X-Frame-Options HTTP header* parameters as needed. Please carefully weigh the risks and benefits before changing default settings. Turning iframe sandboxing or X-Frame-Options HTTP header off completely is not recommended.

Hiding the file with list of common passwords

To increase the complexity of password brute force attacks, limiting access to the `ui/data/top_passwords.txt` file is recommended. This file contains a list of the most common and context-specific passwords and prevents users from setting such passwords (if the *Avoid easy-to-guess passwords* parameter is enabled in the `password policy`).

To limit access to the `top_passwords.txt` file, modify your web server configuration.

On Apache, file access can be limited using the `.htaccess` file:

```
<Files "top_passwords.txt">
  Order Allow,Deny
  Deny from all
</Files>
```

On NGINX, file access can be limited using the `location` directive:

```
location = /data/top_passwords.txt {
    deny all;
    return 404;
}
```

2 Configuration best practices

Overview This section outlines best practices for configuring Zabbix to achieve optimal performance and ease of use. The recommendations are based on the advice of Zabbix developers and practical experience of Zabbix trainers and support engineers.

Every Zabbix installation is unique and some of these guidelines might not be suitable for your specific configuration. However, it is recommended to try to adhere to these guidelines as much as possible to avoid common potential issues.

Note:

If you believe this page could be improved, we'd love to hear from you! Please highlight the text in question and press **ctrl+Enter** to report a mistake or share your feedback.

Hosts and items

Defining a host

A host in Zabbix is not a physical machine or device, but a logical entity. For monitoring purposes, you can create separate hosts for a database or, for example, a virtual machine. Alternatively, you can create a generic host *John's laptop* and monitor all metrics under that host.

The best practice is to create a separate host for each independent instance such as a virtual machine, a database, a container, or a network switch. By utilizing this approach, you will:

1. Avoid clutter in the monitoring data by having separate items, triggers, and alert notifications for each host.
2. Fine-tune user-access levels. You can configure **user-roles** to grant access to viewing and/or configuring only specific hosts. See also [the principle of least privilege](#).

Hosts with duplicated items

If you have several similar hosts, such as *Network switch 1* and *Network switch 2*, Zabbix provides multiple ways to quickly recreate the host. You can simply clone a host with all of its metrics by pressing the Clone button, but in this case, to update an item later, you will need to do it manually on each host.

The best practice is to create a template with all of the required metrics, for example, *Network switch template*. Then group the similar hosts into a host group, for the example above it could be *Network switches*. Now, in the *Data Collection -> Hosts* section you can filter all hosts by host group and use the *Mass update* button to link the template to all of your network switches.

Dependent items

To minimize the number of requests to the target entity, Zabbix allows the creation of master and dependent items. In this case, the master item collects a large set of information in a single request. Then dependent items can be configured to extract specific pieces of data from that collection via preprocessing and store them as individual metrics.

For example, the master item might collect a JSON or XML response containing multiple metrics or execute a database query that returns multiple columns of data (e.g., number of open connections, aborted connections, maximum allowed simultaneous connections, and total cumulative connections since startup), and dependent items will parse and store each required value separately.

The best practice for this configuration is to discard master item's history right after collection and only keep the dependent items data.

Servers and proxies If all hosts are in the same local network as the Zabbix server and there are no scalability or performance concerns, you may not need a proxy. In larger or more complex environments, directly monitoring hosts with the Zabbix server may not be sufficient. Adding a proxy and assigning part of the hosts to that proxy allows for a more even load distribution.

The best practice is to add a Zabbix proxy when:

1. You are monitoring multiple hosts using various metric collection methods behind a firewall. The proxy will gather data from the hosts and forward it to the Zabbix server, reducing the need for opening multiple firewall ports.

2. You are monitoring remote locations, branches, and/or networks. In case of a network interruption between the Zabbix server and your remote locations, the Zabbix proxies deployed in the remote locations will continue data collection and send the collected data back to the Zabbix server whenever the network connection is restored.
3. You have a large-scale deployment and want to reduce the load on Zabbix server and improve performance. The definition of a large-scale deployment is very broad and depends not only on the number of hosts, but also on the number of values collected per second.

20 API

Overview The Zabbix API allows you to programmatically retrieve and modify configuration of Zabbix and provides access to historical data. It is widely used to:

- create new applications to work with Zabbix;
- integrate Zabbix into a third-party software;
- automate routine tasks.

The Zabbix API is an HTTP-based API, and it is shipped as a part of the web frontend. It uses the JSON-RPC 2.0 protocol, which means two things:

- the API consists of a set of separate methods;
- requests and responses between the clients and the API are encoded using the JSON format.

For more information about the protocol and JSON, see the [JSON-RPC 2.0 specification](#) and the [JSON format homepage](#).

For more information about integrating Zabbix functionality into your Python applications, see the [zabbix_utils](#) Python library for Zabbix API.

Structure The API consists of a number of methods that are nominally grouped into separate APIs. Each of the methods performs one specific task. For example, the `host.create` method belongs to the `host` API and is used to create new hosts. Historically, APIs are sometimes referred to as “classes”.

Note:

Most APIs contain at least four methods: `get`, `create`, `update` and `delete` for retrieving, creating, updating and deleting data respectively, but some APIs may provide a totally different set of methods.

Performing requests Once you have set up the frontend, you can use remote HTTP requests to call the API. To do that, you need to send HTTP POST requests to the `api_jsonrpc.php` file located in the frontend directory. For example, if your Zabbix frontend is installed under `https://example.com/zabbix`, an HTTP request to call the `apiinfo.version` method may look like this:

```
curl --request POST \
  --url 'https://example.com/zabbix/api_jsonrpc.php' \
  --header 'Content-Type: application/json-rpc' \
  --data '{"jsonrpc":"2.0","method":"apiinfo.version","params":{},"id":1}'
```

The request must have the `Content-Type` header set to one of these values: `application/json-rpc`, `application/json` or `application/jsonrequest`.

The request object contains the following properties:

- `jsonrpc` - the version of the JSON-RPC protocol used by the API (Zabbix API implements JSON-RPC version 2.0);
- `method` - the API method being called;
- `params` - the parameters that will be passed to the API method;
- `id` - an arbitrary identifier of the request.

If the request is correct, the response returned by the API should look like this:

```
{
  "jsonrpc": "2.0",
  "result": "7.4.0",
  "id": 1
}
```

The response object, in turn, contains the following properties:

- `jsonrpc` - the version of the JSON-RPC protocol;
- `result` - the data returned by the method;
- `id` - an identifier of the corresponding request.

Example workflow The following section will walk you through some examples of usage in a greater detail.

Authentication To access any data in Zabbix, you need to either:

- use an existing **API token** (created in Zabbix frontend or using the **Token API**);
- use an authentication token obtained with the `user.login` method.

For example, if you wanted to obtain a new authentication token by logging in as a standard *Admin* user, then a JSON request would look like this:

```
curl --request POST \
  --url 'https://example.com/zabbix/api_jsonrpc.php' \
  --header 'Content-Type: application/json-rpc' \
  --data '{"jsonrpc": "2.0", "method": "user.login", "params": {"username": "Admin", "password": "zabbix"}, "id": 1}'
```

If you provided the credentials correctly, the response returned by the API should contain the user authentication token:

```
{
  "jsonrpc": "2.0",
  "result": "0424bd59b807674191e7d77572075f33",
  "id": 1
}
```

Authorization methods By "Authorization" header

All API requests require an authentication or an API token. You can provide the credentials by using the Authorization header in the request:

```
curl --request POST \
  --url 'https://example.com/zabbix/api_jsonrpc.php' \
  --header 'Authorization: Bearer 0424bd59b807674191e7d77572075f33'
```

Attention:

If you are using Apache, you may need to change the default Apache configuration in `/etc/apache2/apache2.conf` by adding the following line:

```
SetEnvIf Authorization "(.*)" HTTP_AUTHORIZATION=$1
```

Otherwise, Apache might not send the Authorization header in the request.

By Zabbix cookie

A `zbx_session` cookie is used to authorize an API request from Zabbix UI performed using JavaScript (from a module or a custom widget).

Retrieving hosts Now you have a valid user authentication token that can be used to access the data in Zabbix. For example, you can use the `host.get` method to retrieve the IDs, host names and interfaces of all the configured **hosts**:

Request:

```
curl --request POST \
  --url 'https://example.com/zabbix/api_jsonrpc.php' \
  --header 'Authorization: Bearer ${AUTHORIZATION_TOKEN}' \
  --header 'Content-Type: application/json-rpc' \
  --data @data.json
```

Note:

`data.json` is a file that contains a JSON query. Instead of a file, you can pass the query in the `--data` argument.

`data.json`

```
{
  "jsonrpc": "2.0",
  "method": "host.get",
}
```

```

"params": {
  "output": [
    "hostid",
    "host"
  ],
  "selectInterfaces": [
    "interfaceid",
    "ip"
  ]
},
"id": 2
}

```

The response object will contain the requested data about the hosts:

```

{
  "jsonrpc": "2.0",
  "result": [
    {
      "hostid": "10084",
      "host": "Zabbix server",
      "interfaces": [
        {
          "interfaceid": "1",
          "ip": "127.0.0.1"
        }
      ]
    }
  ],
  "id": 2
}

```

Note:

For performance reasons it is always recommended to list the object properties you want to retrieve. Thus, you will avoid retrieving everything.

Creating a new item Now, create a new **item** on the host "Zabbix server" using the data you have obtained from the previous `host.get` request. This can be done using the `item.create` method:

```

curl --request POST \
  --url 'https://example.com/zabbix/api_jsonrpc.php' \
  --header 'Authorization: Bearer ${AUTHORIZATION_TOKEN}' \
  --header 'Content-Type: application/json-rpc' \
  --data '{"jsonrpc":"2.0","method":"item.create","params":{"name":"Free disk space on /home/joe/","key_":

```

A successful response will contain the ID of the newly created item, which can be used to reference the item in the following requests:

```

{
  "jsonrpc": "2.0",
  "result": {
    "itemids": [
      "24759"
    ]
  },
  "id": 3
}

```

Note:

The `item.create` method as well as other *create methods* can also accept arrays of objects and create multiple items with one API call.

Creating multiple triggers Thus, if *create methods* accept arrays, you can add multiple **triggers**, for example, this one:

```
curl --request POST \
  --url 'https://example.com/zabbix/api_jsonrpc.php' \
  --header 'Authorization: Bearer ${AUTHORIZATION_TOKEN}' \
  --header 'Content-Type: application/json-rpc' \
  --data '{"jsonrpc":"2.0","method":"trigger.create","params":[{"description":"Processor load is too high
```

The successful response will contain the IDs of the newly created triggers:

```
{
  "jsonrpc": "2.0",
  "result": {
    "triggerids": [
      "17369",
      "17370"
    ]
  },
  "id": 4
}
```

Updating an item Enable an item by setting its status to "0":

```
curl --request POST \
  --url 'https://example.com/zabbix/api_jsonrpc.php' \
  --header 'Authorization: Bearer ${AUTHORIZATION_TOKEN}' \
  --header 'Content-Type: application/json-rpc' \
  --data '{"jsonrpc":"2.0","method":"item.update","params":{"itemid":"10092","status":0},"id":5}'
```

The successful response will contain the ID of the updated item:

```
{
  "jsonrpc": "2.0",
  "result": {
    "itemids": [
      "10092"
    ]
  },
  "id": 5
}
```

Note:

The `item.update` method as well as other *update methods* can also accept arrays of objects and update multiple items with one API call.

Updating multiple triggers Enable multiple triggers by setting their status to "0":

```
curl --request POST \
  --url 'https://example.com/zabbix/api_jsonrpc.php' \
  --header 'Authorization: Bearer ${AUTHORIZATION_TOKEN}' \
  --header 'Content-Type: application/json-rpc' \
  --data '{"jsonrpc":"2.0","method":"trigger.update","params":[{"triggerid":"13938","status":0},{triggerid
```

The successful response will contain the IDs of the updated triggers:

```
{
  "jsonrpc": "2.0",
  "result": {
    "triggerids": [
      "13938",
      "13939"
    ]
  },
  "id": 6
}
```

Note:

This is the preferred method of updating. Some API methods, such as the `host.massupdate` allow to write a simpler code. However, it is not recommended to use these methods as they will be removed in the future releases.

Error handling Up to the present moment, everything you have tried has worked fine. But what would happen if you tried making an incorrect call to the API? Try to create another host by calling `host.create` but omitting the mandatory `groups` parameter:

```
curl --request POST \
  --url 'https://example.com/zabbix/api_jsonrpc.php' \
  --header 'Authorization: Bearer ${AUTHORIZATION_TOKEN}' \
  --header 'Content-Type: application/json-rpc' \
  --data '{"jsonrpc": "2.0", "method": "host.create", "params": {"host": "Linux server", "interfaces": [{"type": 1,
```

The response will then contain an error message:

```
{
  "jsonrpc": "2.0",
  "error": {
    "code": -32602,
    "message": "Invalid params.",
    "data": "No groups for host \"Linux server\"."
  },
  "id": 7
}
```

If an error has occurred, instead of the `result` property, the response object will contain the `error` property with the following data:

- `code` - an error code;
- `message` - a short error summary;
- `data` - a more detailed error message.

Errors can occur in various cases, such as, using incorrect input values, a session timeout or trying to access non-existing objects. Your application should be able to gracefully handle these kinds of errors.

API versions To simplify API versioning, since Zabbix 2.0.4, the version of the API matches the version of Zabbix itself. You can use the `apiinfo.version` method to find out the version of the API you are working with. This can be useful for adjusting your application to use version-specific features.

Zabbix guarantees feature backward compatibility inside a major version. When making backward incompatible changes between major releases, Zabbix usually leaves the old features as deprecated in the next release, and only removes them in the release after that. Occasionally, Zabbix may remove features between major releases without providing any backward compatibility. It is important that you never rely on any deprecated features and migrate to newer alternatives as soon as possible.

Note:

You can follow all the changes made to the API in the [API changelog](#).

Further reading Now, you have enough knowledge to start working with the Zabbix API, however, do not stop here. For further reading you are advised to have a look at the [list of available APIs](#).

Method reference

This section provides an overview of the functions provided by the Zabbix API and will help you find your way around the available classes and methods.

Monitoring The Zabbix API allows you to access history and other data gathered during monitoring.

Dashboards

Manage dashboards and make scheduled reports based on them.

[Dashboard API](#) | [Template dashboard API](#) | [Report API](#)

High availability cluster

Retrieve a list of server nodes and their status.

[High availability cluster API](#)

History

Retrieve historical values gathered by Zabbix monitoring processes for presentation or further processing.

[History API](#)

Trends

Retrieve trend values calculated by Zabbix server for presentation or further processing.

[Trend API](#)

Events

Retrieve events generated by triggers, network discovery and other Zabbix systems for more flexible situation management or third-party tool integration.

[Event API](#)

Problems

Retrieve problems according to the given parameters.

[Problem API](#)

Maps

Configure maps to create detailed dynamic representations of your IT infrastructure.

[Map API](#)

Tasks

Interact with Zabbix server task manager, creating tasks and retrieving response.

[Task API](#)

Services The Zabbix API allows you to access data gathered during service monitoring.

Service Level Agreement

Define Service Level Objectives (SLO), retrieve detailed Service Level Indicators (SLI) information about service performance.

[SLA API](#)

Services

Manage services for service-level monitoring and retrieve detailed SLA information about any service.

[Service API](#)

Data collection The Zabbix API allows you to manage the configuration of your monitoring system.

Hosts and host groups

Manage host groups, hosts and everything related to them, including host interfaces, host macros and maintenance periods.

[Host API](#) | [Host group API](#) | [Host interface API](#) | [User macro API](#) | [Value map API](#) | [Maintenance API](#)

Items

Define items to monitor.

[Item API](#)

Triggers

Configure triggers to notify you about problems in your system. Manage trigger dependencies.

[Trigger API](#)

Graphs

Edit graphs or separate graph items for better presentation of the gathered data.

[Graph API](#) | [Graph item API](#)

Templates and template groups

Manage templates and link them to hosts or other templates.

[Template API](#) | [Template group API](#) | [Value map API](#)

Low-level discovery

Configure low-level discovery rules as well as item, trigger and graph prototypes to monitor dynamic entities.

[LLD rule API](#) | [Item prototype API](#) | [Trigger prototype API](#) | [Graph prototype API](#) | [Host prototype API](#)

Event correlation

Create custom event correlation rules.

[Correlation API](#)

Network discovery

Manage network-level discovery rules to automatically find and monitor new hosts. Gain full access to information about discovered services and hosts.

[Discovery rule API](#) | [Discovery check API](#) | [Discovered host API](#) | [Discovered service API](#)

Export and import

Export and import Zabbix configuration data for configuration backups, migration or large-scale configuration updates.

[Configuration API](#)

Web monitoring

Configure web scenarios to monitor your web applications and services.

[Web scenario API](#)

Alerts The Zabbix API allows you to manage the actions and alerts of your monitoring system.

Actions and alerts

Define actions and operations to notify users about certain events or automatically execute remote commands. Gain access to information about generated alerts and their receivers.

[Action API](#) | [Alert API](#)

Media types

Configure media types and multiple ways users will receive alerts.

[Media type API](#)

Scripts

Configure and execute scripts to help you with your daily tasks.

[Script API](#)

Users The Zabbix API allows you to manage users of your monitoring system.

Users and user groups

Add users that will have access to Zabbix, assign them to user groups and grant permissions. Make roles for granular management of user rights.

[User API](#) | [User group API](#) | [User directory API](#) | [User role API](#)

API Tokens

Manage authorization tokens.

[Token API](#)

Authentication

Change authentication configuration options.

[Authentication API](#)

Administration With the Zabbix API you can change administration settings of your monitoring system.

General

Change certain global configuration options.

[Autoregistration API](#) | [Icon map API](#) | [Image API](#) | [Settings API](#) | [Regular expression API](#) | [Module API](#) | [Connector API](#)

Audit log

Track configuration changes each user has done.

[Audit log API](#)

Housekeeping

Configure housekeeping.

[Housekeeping API](#)

Proxies and proxy groups

Manage the proxies used in your distributed monitoring setup.

[Proxy API](#) | [Proxy group API](#)

Macros

Manage macros.

[User macro API](#)

API information Retrieve the version of the Zabbix API so that your application could use version-specific features.

[API info API](#)

Action

This class is designed to work with actions.

Object references:

- [Action](#)
- [Action operation](#)
- [Action operation message](#)
- [Action operation condition](#)
- [Action recovery operation](#)
- [Action update operation](#)
- [Action filter](#)
- [Action filter condition](#)

Available methods:

- [action.create](#) - create new actions
- [action.delete](#) - delete actions
- [action.get](#) - retrieve actions
- [action.update](#) - update actions

Action object

The following objects are directly related to the `action` API.

Action

The action object has the following properties.

Property	Type	Description
<code>actionid</code>	ID	ID of the action.

Property behavior:
- *read-only*
- *required* for update operations

Property	Type	Description
esc_period	string	Default operation step duration. Must be at least 60 seconds. Accepts seconds, time unit with suffix, or a user macro.
eventsources	integer	<p>Property behavior:</p> <ul style="list-style-type: none"> - <i>supported</i> if <code>eventsources</code> is set to "event created by a trigger", "internal event", or "event created on service status update" <p>Type of events that the action will handle.</p> <p>Refer to the event source property for a list of supported event types.</p> <p>Property behavior:</p> <ul style="list-style-type: none"> - <i>constant</i> - <i>required</i> for create operations
name	string	<p>Name of the action.</p> <p>Property behavior:</p> <ul style="list-style-type: none"> - <i>required</i> for create operations
status	integer	<p>Whether the action is enabled or disabled.</p> <p>Possible values:</p> <ul style="list-style-type: none"> 0 - (<i>default</i>) enabled; 1 - disabled.
pause_symptoms	integer	<p>Whether to pause escalation if event is a symptom event.</p> <p>Possible values:</p> <ul style="list-style-type: none"> 0 - Don't pause escalation for symptom problems; 1 - (<i>default</i>) Pause escalation for symptom problems.
pause_suppressed	integer	<p>Whether to pause escalation during maintenance periods or not.</p> <p>Possible values:</p> <ul style="list-style-type: none"> 0 - Don't pause escalation; 1 - (<i>default</i>) Pause escalation. <p>Property behavior:</p> <ul style="list-style-type: none"> - <i>supported</i> if <code>eventsources</code> is set to "event created by a trigger"
notify_if_canceled	integer	<p>Whether to notify when escalation is canceled.</p> <p>Possible values:</p> <ul style="list-style-type: none"> 0 - Don't notify when escalation is canceled; 1 - (<i>default</i>) Notify when escalation is canceled. <p>Property behavior:</p> <ul style="list-style-type: none"> - <i>supported</i> if <code>eventsources</code> is set to "event created by a trigger"

Action operation

The action operation object defines an operation that will be performed when an action is executed. It has the following properties.

Property	Type	Description
operationtype	integer	<p>Type of operation.</p> <p>Possible values:</p> <ul style="list-style-type: none"> 0 - send message; 1 - global script; 2 - add host; 3 - remove host; 4 - add to host group; 5 - remove from host group; 6 - link template; 7 - unlink template; 8 - enable host; 9 - disable host; 10 - set host inventory mode; 13 - add host tags; 14 - remove host tags. <p>Possible values if <code>eventsource</code> of Action object is set to "event created by a trigger" or "event created on service status update":</p> <ul style="list-style-type: none"> 0 - "send message"; 1 - "global script". <p>Possible values if <code>eventsource</code> of Action object is set to "internal event":</p> <ul style="list-style-type: none"> 0 - "send message".
esc_period	string	<p>Property behavior:</p> <ul style="list-style-type: none"> - <i>required</i> <p>Duration of an escalation step in seconds. Must be greater than 60 seconds. Accepts seconds, time unit with suffix, or a user macro. If set to 0 or 0s, the default action escalation period will be used.</p> <p>Default: 0s.</p> <p>Property behavior:</p> <ul style="list-style-type: none"> - <i>supported</i> if <code>eventsource</code> of Action object is set to "event created by a trigger", "internal event", or "event created on service status update"
esc_step_from	integer	<p>Step to start escalation from.</p> <p>Default: 1.</p> <p>Property behavior:</p> <ul style="list-style-type: none"> - <i>supported</i> if <code>eventsource</code> of Action object is set to "event created by a trigger", "internal event", or "event created on service status update"
esc_step_to	integer	<p>Step to end escalation at.</p> <p>Default: 1.</p> <p>Property behavior:</p> <ul style="list-style-type: none"> - <i>supported</i> if <code>eventsource</code> of Action object is set to "event created by a trigger", "internal event", or "event created on service status update"
evaltype	integer	<p>Operation condition evaluation method.</p> <p>Possible values:</p> <ul style="list-style-type: none"> 0 - (<i>default</i>) AND / OR; 1 - AND; 2 - OR.

Property	Type	Description
opcommand	object	Global script to execute. The global script must have the <code>scriptid</code> property defined.
opcommand_grp	array	Property behavior: - <i>required</i> if <code>operationtype</code> is set to "global script" Host groups to run global scripts on. The host groups must have the <code>groupid</code> property defined.
opcommand_hst	array	Property behavior: - <i>required</i> if <code>operationtype</code> is set to "global script" and <code>opcommand_hst</code> is not set Host to run global scripts on. The hosts must have the <code>hostid</code> property defined.
opconditions	array	Property behavior: - <i>required</i> if <code>operationtype</code> is set to "global script" and <code>opcommand_grp</code> is not set Operation conditions used for trigger actions.
opgroup	array	The operation condition object is described in detail below . Host groups to add hosts to. The host groups must have the <code>groupid</code> property defined.
opmessage	object	Property behavior: - <i>required</i> if <code>operationtype</code> is set to "add to host group" or "remove from host group" Object containing the data about the message sent by the operation. The operation message object is described in detail below .
opmessage_grp	array	Property behavior: - <i>required</i> if <code>operationtype</code> is set to "send message" User groups to send messages to. The user groups must have the <code>usrgrp</code> property defined.
opmessage_usr	array	Property behavior: - <i>required</i> if <code>operationtype</code> is set to "send message" and <code>opmessage_usr</code> is not set Users to send messages to. The users must have the <code>userid</code> property defined.
optemplate	array	Property behavior: - <i>required</i> if <code>operationtype</code> is set to "send message" and <code>opmessage_grp</code> is not set Templates to link to the hosts. The templates must have the <code>templateid</code> property defined.
		Property behavior: - <i>required</i> if <code>operationtype</code> is set to "link template" or "unlink template"

Property	Type	Description
opinVENTORY	object	Inventory mode set host to. The inventory must have the <code>inventory_mode</code> property defined.
optag	array	Property behavior: - <i>required</i> if <code>operationtype</code> is set to "set host inventory mode" Host tags to add or remove. Tags must have <code>tag</code> property defined. The <code>value</code> property is optional. Property behavior: - <i>supported</i> if <code>operationtype</code> is set to "add host tags" or "remove host tags".

Action operation message

The operation message object contains data about the message that will be sent by the operation. It has the following properties.

Property	Type	Description
default_msg	integer	Whether to use the default action message text and subject. Possible values: 0 - use the data from the operation; 1 - (<i>default</i>) use the data from the media type.
mediatypeid	ID	ID of the media type that will be used to send the message. Property behavior: - <i>supported</i> if <code>operationtype</code> of Action operation object , Action recovery operation object , or Action update operation object is set to "send message", or if <code>operationtype</code> of Action update operation object is set to "notify all involved"
message	string	Operation message text. Property behavior: - <i>supported</i> if <code>default_msg</code> is set to "use the data from the operation"
subject	string	Operation message subject. Property behavior: - <i>supported</i> if <code>default_msg</code> is set to "use the data from the operation"

Action operation condition

The action operation condition object defines a condition that must be met to perform the current operation. It has the following properties.

Property	Type	Description
conditiontype	integer	Type of condition. Possible values: 14 - event acknowledged. Property behavior: - <i>required</i>
value	string	Value to compare with. Property behavior: - <i>required</i>

Property	Type	Description
operator	integer	Condition operator. Possible values: 0 - (default) =

The following operators and values are supported for each operation condition type.

Condition	Condition name	Supported operators	Expected value
14	Event acknowledged	=	Whether the event is acknowledged. Possible values: 0 - not acknowledged; 1 - acknowledged.

Action recovery operation

The action recovery operation object defines an operation that will be performed when a problem is resolved. Recovery operations are possible **only** for trigger, internal and service actions. It has the following properties.

Property	Type	Description
operationtype	integer	Type of operation. Possible values if eventsource of Action object is set to "event created by a trigger" or "event created on service status update": 0 - send message; 1 - global script; 11 - notify all involved. Possible values if eventsource of Action object is set to "internal event": 0 - send message; 11 - notify all involved.
opcommand	object	Property behavior: - <i>required</i> Global script to execute. The global script must have the scriptid property defined.
opcommand_grp	array	Property behavior: - <i>required</i> if operationtype is set to "global script" Host groups to run global scripts on. The host groups must have the groupid property defined.
opcommand_hst	array	Property behavior: - <i>required</i> if eventsource of Action object is set to "event created by a trigger", and operationtype is set to "global script", and opcommand_hst is not set Host to run global scripts on. The hosts must have the hostid property defined.
		Property behavior: - <i>required</i> if eventsource of Action object is set to "event created by a trigger", and operationtype is set to "global script", and opcommand_grp is not set

Property	Type	Description
opmessage	object	Object containing the data about the message sent by the recovery operation. The operation message object is described in detail above .
opmessage_grp	array	Property behavior: - <i>required</i> if <code>operationtype</code> is set to "send message" User groups to send messages to. The user groups must have the <code>usrgrp</code> property defined. Property behavior: - <i>required</i> if <code>operationtype</code> is set to "send message" and <code>opmessage_usr</code> is not set
opmessage_usr	array	Users to send messages to. The users must have the <code>userid</code> property defined. Property behavior: - <i>required</i> if <code>operationtype</code> is set to "send message" and <code>opmessage_grp</code> is not set

Action update operation

The action update operation object defines an operation that will be performed when a problem is updated (commented upon, acknowledged, severity changed, or manually closed). Update operations are possible **only** for trigger and service actions. It has the following properties.

Property	Type	Description
operationtype	integer	Type of operation. Possible values: 0 - send message; 1 - global script; 12 - notify all involved.
opcommand	object	Property behavior: - <i>required</i> Global script to execute. The global script must have the <code>scriptid</code> property defined. Property behavior: - <i>required</i> if <code>operationtype</code> is set to "global script"
opcommand_grp	array	Host groups to run global scripts on. The host groups must have the <code>groupid</code> property defined. Property behavior: - <i>required</i> if <code>eventsource</code> of Action object is set to "event created by a trigger", and <code>operationtype</code> is set to "global script", and <code>opcommand_hst</code> is not set
opcommand_hst	array	Host to run global scripts on. The hosts must have the <code>hostid</code> property defined. Property behavior: - <i>required</i> if <code>eventsource</code> of Action object is set to "event created by a trigger", and <code>operationtype</code> is set to "global script", and <code>opcommand_grp</code> is not set

Property	Type	Description
opmessage	object	Object containing the data about the message sent by the update operation.
opmessage_grp	array	The operation message object is described in detail above . User groups to send messages to. The user groups must have the <code>usrgrp_id</code> property defined. Property behavior: - <i>required</i> if <code>operationtype</code> is set to "send message" and <code>opmessage_usr</code> is not set
opmessage_usr	array	Users to send messages to. The users must have the <code>userid</code> property defined. Property behavior: - <i>required</i> if <code>operationtype</code> is set to "send message" and <code>opmessage_grp</code> is not set

Action filter

The action filter object defines a set of conditions that must be met to perform the configured action operations. It has the following properties.

Property	Type	Description
conditions	array	Set of filter conditions to use for filtering results. The conditions will be sorted in the order of their placement in the formula. Property behavior: - <i>required</i>
evaltype	integer	Filter condition evaluation method. Possible values: 0 - and/or; 1 - and; 2 - or; 3 - custom expression. Property behavior: - <i>required</i>
eval_formula	string	Generated expression that will be used for evaluating filter conditions. The expression contains IDs that reference specific filter conditions by its <code>formulaid</code> . The value of <code>eval_formula</code> is equal to the value of <code>formula</code> for filters with a custom expression. Property behavior: - <i>read-only</i>
formula	string	User-defined expression to be used for evaluating conditions of filters with a custom expression. The expression must contain IDs that reference specific filter conditions by its <code>formulaid</code> . The IDs used in the expression must exactly match the ones defined in the filter conditions: no condition can remain unused or omitted. Property behavior: - <i>required</i> if <code>evaltype</code> is set to "custom expression"

Action filter condition

The action filter condition object defines a specific condition that must be checked before running the action operations.

Property	Type	Description
conditiontype	integer	<p>Type of condition.</p> <p>Possible values if eventsource of Action object is set to "event created by a trigger":</p> <ul style="list-style-type: none"> 0 - host group; 1 - host; 2 - trigger; 3 - event name; 4 - trigger severity; 6 - time period; 13 - host template; 16 - problem is suppressed; 25 - event tag; 26 - event tag value. <p>Possible values if eventsource of Action object is set to "event created by a discovery rule":</p> <ul style="list-style-type: none"> 7 - host IP; 8 - discovered service type; 9 - discovered service port; 10 - discovery status; 11 - uptime or downtime duration; 12 - received value; 18 - discovery rule; 19 - discovery check; 20 - proxy; 21 - discovery object. <p>Possible values if eventsource of Action object is set to "event created by active agent autoregistration":</p> <ul style="list-style-type: none"> 20 - proxy; 22 - host name; 24 - host metadata. <p>Possible values if eventsource of Action object is set to "internal event":</p> <ul style="list-style-type: none"> 0 - host group; 1 - host; 13 - host template; 23 - event type; 25 - event tag; 26 - event tag value. <p>Possible values if eventsource of Action object is set to "event created on service status update":</p> <ul style="list-style-type: none"> 25 - event tag; 26 - event tag value; 27 - service; 28 - service name. <p>Property behavior:</p> <ul style="list-style-type: none"> - <i>required</i>
value	string	<p>Value to compare with.</p> <p>Property behavior:</p> <ul style="list-style-type: none"> - <i>required</i>

Property	Type	Description
value2	string	Secondary value to compare with.
		<p>Property behavior:</p> <ul style="list-style-type: none"> - <i>required</i> if <code>eventsourcesource</code> of Action object is set to "event created by a trigger", <code>conditiontype</code> is set to any possible value for trigger actions, and the type of condition (see below) is "26" - <i>required</i> if <code>eventsourcesource</code> of Action object is set to "internal event", <code>conditiontype</code> is set to any possible value for internal actions, and the type of condition (see below) is "26" - <i>required</i> if <code>eventsourcesource</code> of Action object is set to "event created on service status update", <code>conditiontype</code> is set to any possible value for service actions, and the type of condition (see below) is "26"
formulaid	string	Arbitrary unique ID that is used to reference the condition from a custom expression. Can only contain capital-case letters. The ID must be defined by the user when modifying filter conditions, but will be generated anew when requesting them afterward.
operator	integer	Condition operator.
		<p>Possible values:</p> <ul style="list-style-type: none"> 0 - (default) equals; 1 - does not equal; 2 - contains; 3 - does not contain; 4 - in; 5 - is greater than or equals; 6 - is less than or equals; 7 - not in; 8 - matches; 9 - does not match; 10 - Yes; 11 - No.

Note:

To better understand how to use filters with various types of expressions, see examples on the [action.get](#) and [action.create](#) method pages.

The following operators and values are supported for each condition type.

Condition	Condition name	Supported operators	Expected value
0	Host group	equals, does not equal	Host group ID.
1	Host	equals, does not equal	Host ID.
2	Trigger	equals, does not equal	Trigger ID.
3	Event name	contains, does not contain	Event name.
4	Trigger severity	equals, does not equal, is greater than or equals, is less than or equals	Trigger severity. Refer to the trigger severity property for a list of supported trigger severities.
5	Trigger value	equals	Trigger value. Refer to the trigger value property for a list of supported trigger values.
6	Time period	in, not in	Time when the event was triggered as a time period .
7	Host IP	equals, does not equal	One or several IP ranges to check, separated by commas. Refer to the network discovery configuration section for more information on supported formats of IP ranges.

Condition	Condition name	Supported operators	Expected value
8	Discovered service type	equals, does not equal	Type of discovered service. The type of service matches the type of the discovery check used to detect the service. Refer to the discovery check type property for a list of supported types.
9	Discovered service port	equals, does not equal	One or several port ranges, separated by commas.
10	Discovery status	equals	Status of a discovered object. Possible values: 0 - host or service up; 1 - host or service down; 2 - host or service discovered; 3 - host or service lost.
11	Uptime or downtime duration	is greater than or equals, is less than or equals	Time indicating how long has the discovered object been in the current status in seconds.
12	Received values	equals, does not equal, is greater than or equals, is less than or equals, contains, does not contain	Value returned when performing a Zabbix agent, SNMPv1, SNMPv2 or SNMPv3 discovery check.
13	Host template	equals, does not equal	Linked template ID.
16	Problem is suppressed	Yes, No	No value required: using the "Yes" operator means that problem must be suppressed, "No" - not suppressed.
18	Discovery rule	equals, does not equal	ID of the discovery rule.
19	Discovery check	equals, does not equal	ID of the discovery check.
20	Proxy	equals, does not equal	ID of the proxy.
21	Discovery object	equals	Type of object that triggered the discovery event. Possible values: 1 - discovered host; 2 - discovered service.
22	Host name	contains, does not contain, matches, does not match	Host name. Using a regular expression is supported for operators <i>matches</i> and <i>does not match</i> in autoregistration conditions.
23	Event type	equals	Specific internal event. Possible values: 0 - item in "not supported" state; 1 - item in "normal" state; 2 - LLD rule in "not supported" state; 3 - LLD rule in "normal" state; 4 - trigger in "unknown" state; 5 - trigger in "normal" state.
24	Host metadata	contains, does not contain, matches, does not match	Metadata of the auto-registered host. Using a regular expression is supported for operators <i>matches</i> and <i>does not match</i> .
25	Tag	equals, does not equal, contains, does not contain	Event tag.

Condition	Condition name	Supported operators	Expected value
26	Tag value	equals, does not equal, contains, does not contain	Event tag value.
27	Service	equals, does not equal	Service ID.
28	Service name	equals, does not equal	Service name.

action.create

Description

object action.create(object/array actions)

This method allows to create new actions.

Note:

This method is only available to *Admin* and *Super admin* user types. Permissions to call the method can be revoked in user role settings. See [User roles](#) for more information.

Parameters

(object/array) Actions to create.

Additionally to the [standard action properties](#), the method accepts the following parameters.

Parameter	Type	Description
filter	object	Action filter object for the action.
operations	array	Action operations to create for the action.
recovery_operations	array	Action recovery operations to create for the action.
update_operations	array	Action update operations to create for the action.

Return values

(object) Returns an object containing the IDs of the created actions under the `actionids` property. The order of the returned IDs matches the order of the passed actions.

Examples

Create a trigger action

Create a trigger action that will begin once a trigger (with the word "memory" in its name) from host "10084" goes into a PROBLEM state. The action will have 4 configured operations. The first and immediate operation will send a message to all users in user group "7" via media type "1". If the event is not resolved in 30 minutes, the second operation will run `script "5"` (script with scope "Action operation") on all hosts in group "2". If the event is resolved, a recovery operation will notify all users who received any messages regarding the problem. If the event is updated, an acknowledge/update operation will notify (with a custom subject and message) all users who received any messages regarding the problem.

Request:

```
{
  "jsonrpc": "2.0",
  "method": "action.create",
  "params": {
    "name": "Trigger action",
    "eventsources": 0,
    "esc_period": "30m",
    "filter": {
      "evaltype": 0,
      "conditions": [
        {
          "conditiontype": 1,
```

```

        "operator": 0,
        "value": "10084"
    },
    {
        "conditiontype": 3,
        "operator": 2,
        "value": "memory"
    }
]
},
"operations": [
    {
        "operationtype": 0,
        "esc_step_from": 1,
        "esc_step_to": 1,
        "opmessage_grp": [
            {
                "usrgrp": "7"
            }
        ],
        "opmessage": {
            "default_msg": 1,
            "mediatypeid": "1"
        }
    },
    {
        "operationtype": 1,
        "esc_step_from": 2,
        "esc_step_to": 2,
        "opconditions": [
            {
                "conditiontype": 14,
                "operator": 0,
                "value": "0"
            }
        ],
        "opcommand_grp": [
            {
                "groupid": "2"
            }
        ],
        "opcommand": {
            "scriptid": "5"
        }
    }
],
"recovery_operations": [
    {
        "operationtype": "11",
        "opmessage": {
            "default_msg": 1
        }
    }
],
"update_operations": [
    {
        "operationtype": "12",
        "opmessage": {
            "default_msg": 0,
            "message": "Custom update operation message body",
            "subject": "Custom update operation message subject"
        }
    }
]
}

```

```
    }
  ],
  "id": 1
}
```

Response:

```
{
  "jsonrpc": "2.0",
  "result": {
    "actionids": [
      "17"
    ]
  },
  "id": 1
}
```

Create a discovery action

Create a discovery action that will link template "10001" to discovered hosts.

Request:

```
{
  "jsonrpc": "2.0",
  "method": "action.create",
  "params": {
    "name": "Discovery action",
    "eventsources": 1,
    "filter": {
      "evaltype": 0,
      "conditions": [
        {
          "conditiontype": 21,
          "operator": 0,
          "value": "1"
        },
        {
          "conditiontype": 10,
          "operator": 0,
          "value": "2"
        }
      ]
    },
    "operations": [
      {
        "operationtype": 6,
        "optemplate": [
          {
            "templateid": "10001"
          }
        ]
      }
    ]
  },
  "id": 1
}
```

Response:

```
{
  "jsonrpc": "2.0",
  "result": {
    "actionids": [
      "18"
    ]
  }
}
```

```

    ],
    "id": 1
}

```

Using a custom expression filter

Create a trigger action that uses a custom expression - "A and (B or C)" - for evaluating action conditions. Once a trigger with a severity higher or equal to "Warning" from host "10084" or host "10106" goes into a PROBLEM state, the action will send a message to all users in user group "7" via media type "1". The formula IDs "A", "B" and "C" have been chosen arbitrarily.

Request:

```

{
  "jsonrpc": "2.0",
  "method": "action.create",
  "params": {
    "name": "Trigger action",
    "eventsources": 0,
    "esc_period": "15m",
    "filter": {
      "evaltype": 3,
      "formula": "A and (B or C)",
      "conditions": [
        {
          "conditiontype": 4,
          "operator": 5,
          "value": "2",
          "formulaid": "A"
        },
        {
          "conditiontype": 1,
          "operator": 0,
          "value": "10084",
          "formulaid": "B"
        },
        {
          "conditiontype": 1,
          "operator": 0,
          "value": "10106",
          "formulaid": "C"
        }
      ]
    },
    "operations": [
      {
        "operationtype": 0,
        "esc_step_from": 1,
        "esc_step_to": 1,
        "opmessage_grp": [
          {
            "usrgrp": "7"
          }
        ],
        "opmessage": {
          "default_msg": 1,
          "mediatypeid": "1"
        }
      }
    ]
  },
  "id": 1
}

```

Response:

```

{
  "jsonrpc": "2.0",
  "result": {
    "actionids": [
      "18"
    ]
  },
  "id": 1
}

```

Create agent autoregistration rule

Create an autoregistration action that adds a host to host group "2" when the host name contains "SRV" or metadata contains "AlmaLinux".

Request:

```

{
  "jsonrpc": "2.0",
  "method": "action.create",
  "params": {
    "name": "Register Linux servers",
    "eventsources": "2",
    "filter": {
      "evaltype": "2",
      "conditions": [
        {
          "conditiontype": "22",
          "operator": "2",
          "value": "SRV"
        },
        {
          "conditiontype": "24",
          "operator": "2",
          "value": "AlmaLinux"
        }
      ]
    },
    "operations": [
      {
        "operationtype": "4",
        "opgroup": [
          {
            "groupid": "2"
          }
        ]
      }
    ]
  },
  "id": 1
}

```

Response:

```

{
  "jsonrpc": "2.0",
  "result": {
    "actionids": [
      19
    ]
  },
  "id": 1
}

```

Create agent autoregistration rule with host tags

Create an autoregistration action that adds a host to host group "2" and adds two host tags.

Request:

```
{
  "jsonrpc": "2.0",
  "method": "action.create",
  "params": {
    "name": "Register Linux servers with tags",
    "eventsources": "2",
    "operations": [
      {
        "operationtype": "4",
        "opgroup": [
          {
            "groupid": "2"
          }
        ]
      },
      {
        "operationtype": "13",
        "optag": [
          {
            "tag": "location",
            "value": "office"
          },
          {
            "tag": "city",
            "value": "Riga"
          }
        ]
      }
    ]
  },
  "id": 1
}
```

Response:

```
{
  "jsonrpc": "2.0",
  "result": {
    "actionids": [
      20
    ]
  },
  "id": 1
}
```

See also

- [Action filter](#)
- [Action operation](#)
- [Script](#)

Source

CAction::create() in *ui/include/classes/api/services/CAction.php*.

action.delete

Description

object action.delete(array actionIds)

This method allows to delete actions.

Note:

This method is only available to *Admin* and *Super admin* user types. Permissions to call the method can be revoked in user role settings. See [User roles](#) for more information.

Parameters

(array) IDs of the actions to delete.

Return values

(object) Returns an object containing the IDs of the deleted actions under the `actionids` property.

Examples**Delete multiple actions**

Delete two actions.

Request:

```
{
  "jsonrpc": "2.0",
  "method": "action.delete",
  "params": [
    "17",
    "18"
  ],
  "id": 1
}
```

Response:

```
{
  "jsonrpc": "2.0",
  "result": {
    "actionids": [
      "17",
      "18"
    ]
  },
  "id": 1
}
```

Source

CAction::delete() in `ui/include/classes/api/services/CAction.php`.

action.get**Description**

integer/array `action.get(object parameters)`

The method allows to retrieve actions according to the given parameters.

Note:

This method is available to users of any type. Permissions to call the method can be revoked in user role settings. See [User roles](#) for more information.

Parameters

(object) Parameters defining the desired output.

The method supports the following parameters.

Parameter	Type	Description
actionids	ID/array	Return only actions with the given IDs.
groupids	ID/array	Return only actions that use the given host groups in action conditions.
hostids	ID/array	Return only actions that use the given hosts in action conditions.

Parameter	Type	Description
triggerids	ID/array	Return only actions that use the given triggers in action conditions.
mediatypeids	ID/array	Return only actions that use the given media types to send messages.
usrgrpids	ID/array	Return only actions that are configured to send messages to the given user groups.
userid	ID/array	Return only actions that are configured to send messages to the given users.
scriptids	ID/array	Return only actions that are configured to run the given scripts.
selectFilter	query	Return a filter property with the action condition filter.
selectOperations	query	Return an operations property with action operations.
selectRecoveryOperations	query	Return a recovery_operations property with action recovery operations.
selectUpdateOperations	query	Return an update_operations property with action update operations.
sortfield	string/array	Sort the result by the given properties. Possible values: <code>actionid</code> , <code>name</code> , <code>status</code> .
countOutput	boolean	These parameters being common for all get methods are described in the reference commentary .
excludeSearch	boolean	
filter	object	
limit	integer	
output	query	
preservekeys	boolean	
search	object	
searchByAny	boolean	
searchWildcardsEnabled	boolean	
sortorder	string/array	
startSearch	boolean	

Return values

(integer/array) Returns either:

- an array of objects;
- the count of retrieved objects, if the `countOutput` parameter has been used.

Examples

Retrieve trigger actions

Retrieve all configured trigger actions together with action conditions and operations.

Request:

```
{
  "jsonrpc": "2.0",
  "method": "action.get",
  "params": {
    "output": "extend",
    "selectOperations": "extend",
    "selectRecoveryOperations": "extend",
    "selectUpdateOperations": "extend",
    "selectFilter": "extend",
    "filter": {
      "eventsources": 0
    }
  },
  "id": 1
}
```

Response:

```
{
  "jsonrpc": "2.0",
  "result": [
```

```

{
  "actionid": "3",
  "name": "Report problems to Zabbix administrators",
  "eventsources": "0",
  "status": "1",
  "esc_period": "1h",
  "pause_suppressed": "1",
  "filter": {
    "evaltype": "0",
    "formula": "",
    "conditions": [],
    "eval_formula": ""
  },
  "operations": [
    {
      "operationid": "3",
      "actionid": "3",
      "operationtype": "0",
      "esc_period": "0",
      "esc_step_from": "1",
      "esc_step_to": "1",
      "evaltype": "0",
      "opconditions": [],
      "opmessage": [
        {
          "default_msg": "1",
          "subject": "",
          "message": "",
          "mediatypeid" => "0"
        }
      ],
      "opmessage_grp": [
        {
          "usrgrpid": "7"
        }
      ]
    }
  ],
  "recovery_operations": [
    {
      "operationid": "7",
      "actionid": "3",
      "operationtype": "11",
      "evaltype": "0",
      "opconditions": [],
      "opmessage": {
        "default_msg": "0",
        "subject": "{TRIGGER.STATUS}: {TRIGGER.NAME}",
        "message": "Trigger: {TRIGGER.NAME}\r\nTrigger status: {TRIGGER.STATUS}\r\nTrigger",
        "mediatypeid": "0"
      }
    }
  ],
  "update_operations": [
    {
      "operationid": "31",
      "operationtype": "12",
      "evaltype": "0",
      "opmessage": {
        "default_msg": "1",
        "subject": "",
        "message": ""
      }
    }
  ]
}

```

```

        "mediatypeid": "0"
      }
    },
    {
      "operationid": "32",
      "operationtype": "0",
      "evaltype": "0",
      "opmessage": {
        "default_msg": "0",
        "subject": "Updated: {TRIGGER.NAME}",
        "message": "{USER.FULLNAME} updated problem at {EVENT.UPDATE.DATE} {EVENT.UPDATE.T",
        "mediatypeid": "1"
      },
      "opmessage_grp": [
        {
          "usrgrp": "7"
        }
      ],
      "opmessage_usr": []
    },
    {
      "operationid": "33",
      "operationtype": "1",
      "evaltype": "0",
      "opcommand": {
        "scriptid": "3"
      },
      "opcommand_hst": [
        {
          "hostid": "10084"
        }
      ],
      "opcommand_grp": []
    }
  ]
}
],
"id": 1
}

```

Retrieve discovery actions

Retrieve all configured discovery actions together with action conditions and operations. The filter uses the "and" evaluation type, so the formula property is empty and eval_formula is generated automatically.

Request:

```

{
  "jsonrpc": "2.0",
  "method": "action.get",
  "params": {
    "output": "extend",
    "selectOperations": "extend",
    "selectFilter": "extend",
    "filter": {
      "eventsources": 1
    }
  },
  "id": 1
}

```

Response:

```

{
  "jsonrpc": "2.0",

```

```

"result": [
  {
    "actionid": "2",
    "name": "Auto discovery. Linux servers.",
    "eventsources": "1",
    "status": "1",
    "esc_period": "0s",
    "pause_suppressed": "1",
    "filter": {
      "evaltype": "0",
      "formula": "",
      "conditions": [
        {
          "conditiontype": "10",
          "operator": "0",
          "value": "0",
          "value2": "",
          "formulaid": "B"
        },
        {
          "conditiontype": "8",
          "operator": "0",
          "value": "9",
          "value2": "",
          "formulaid": "C"
        },
        {
          "conditiontype": "12",
          "operator": "2",
          "value": "Linux",
          "value2": "",
          "formulaid": "A"
        }
      ],
      "eval_formula": "A and B and C"
    },
    "operations": [
      {
        "operationid": "1",
        "actionid": "2",
        "operationtype": "6",
        "esc_period": "0s",
        "esc_step_from": "1",
        "esc_step_to": "1",
        "evaltype": "0",
        "opconditions": [],
        "optemplate": [
          {
            "templateid": "10001"
          }
        ]
      },
      {
        "operationid": "2",
        "actionid": "2",
        "operationtype": "4",
        "esc_period": "0s",
        "esc_step_from": "1",
        "esc_step_to": "1",
        "evaltype": "0",
        "opconditions": [],
        "opgroup": [

```

```

    {
      "groupid": "2"
    }
  ],
  "id": 1
}

```

See also

- [Action filter](#)
- [Action operation](#)

Source

CAction::get() in `ui/include/classes/api/services/CAction.php`.

action.update

Description

object action.update(object/array actions)

This method allows to update existing actions.

Note:

This method is only available to *Admin* and *Super admin* user types. Permissions to call the method can be revoked in user role settings. See [User roles](#) for more information.

Parameters

(object/array) Action properties to be updated.

The `actionid` property must be defined for each action, all other properties are optional. Only the passed properties will be updated, all others will remain unchanged.

Additionally to the [standard action properties](#), the method accepts the following parameters.

Parameter	Type	Description
filter	object	Action filter object to replace the current filter.
operations	array	Action operations to replace existing operations.
recovery_operations	array	Action recovery operations to replace existing recovery operations.
		Parameter behavior: - <i>supported</i> if <code>eventsources</code> of Action object is set to "event created by a trigger", "internal event", or "event created on service status update"
update_operations	array	Action update operations to replace existing update operations.
		Parameter behavior: - <i>supported</i> if <code>eventsources</code> of Action object is set to "event created by a trigger" or "event created on service status update"

Return values

(object) Returns an object containing the IDs of the updated actions under the `actionids` property.

Examples

Disable action

Disable an action, that is, set its status to "1".

Request:

```
{
  "jsonrpc": "2.0",
  "method": "action.update",
  "params": {
    "actionid": "2",
    "status": "1"
  },
  "id": 1
}
```

Response:

```
{
  "jsonrpc": "2.0",
  "result": {
    "actionids": [
      "2"
    ]
  },
  "id": 1
}
```

See also

- [Action filter](#)
- [Action operation](#)

Source

CAction::update() in *ui/include/classes/api/services/CAction.php*.

Alert

This class is designed to work with alerts.

Object references:

- [Alert](#)

Available methods:

- [alert.get](#) - retrieve alerts

Alert object

The following objects are directly related to the alert API.

Alert

Note:

Alerts are created by Zabbix server and cannot be modified via the API.

The alert object contains information about whether certain action operations have been executed successfully. It has the following properties.

Property	Type	Description
alertid	ID	ID of the alert.
actionid	ID	ID of the action that generated the alert.
alerttype	integer	Alert type. Possible values: 0 - message; 1 - remote command.
clock	timestamp	Time when the alert was generated.
error	string	Error text if there are problems sending a message or running a command.

Property	Type	Description
esc_step	integer	Action escalation step during which the alert was generated.
eventid	ID	ID of the event that triggered the action.
mediatypeid	ID	ID of the media type that was used to send the message.
message	text	Message text.
Property behavior:		
- <i>supported</i> if alerttype is set to "message"		
retries	integer	Number of times Zabbix tried to send the message.
sendto	string	Address, user name or other identifier of the recipient.
Property behavior:		
- <i>supported</i> if alerttype is set to "message"		
status	integer	Status indicating whether the action operation has been executed successfully.
Possible values if alerttype is set to "message":		
0 - message not sent;		
1 - message sent;		
2 - failed after a number of retries;		
3 - new alert is not yet processed by alert manager.		
Possible values if alerttype is set to "remote command":		
0 - command not run;		
1 - command run;		
2 - tried to run the command on Zabbix agent, but it was unavailable.		
subject	string	Message subject.
Property behavior:		
- <i>supported</i> if alerttype is set to "message"		
userid	ID	ID of the user that the message was sent to.
p_eventid	ID	ID of problem event, which generated the alert.
acknowledgeid	ID	ID of acknowledgment, which generated the alert.

alert.get

Description

integer/array alert.get(object parameters)

The method allows to retrieve alerts according to the given parameters.

Note:

This method is available to users of any type. Permissions to call the method can be revoked in user role settings. See [User roles](#) for more information.

Parameters

(object) Parameters defining the desired output.

The method supports the following parameters.

Parameter	Type	Description
alertids	ID/array	Return only alerts with the given IDs.
actionids	ID/array	Return only alerts generated by the given actions.
eventids	ID/array	Return only alerts generated by the given events.
groupids	ID/array	Return only alerts generated by objects from the given host groups.
hostids	ID/array	Return only alerts generated by objects from the given hosts.
mediatypeids	ID/array	Return only message alerts that used the given media types.
objectids	ID/array	Return only alerts generated by the given objects
userid	ID/array	Return only message alerts that were sent to the given users.

Parameter	Type	Description
eventobject	integer	Return only alerts generated by events related to objects of the given type. See event object for a list of supported object types. Default: 0 - trigger.
eventsources	integer	Return only alerts generated by events of the given type. See event source for a list of supported event types. Default: 0 - trigger events.
time_from	timestamp	Return only alerts that have been generated after the given time.
time_till	timestamp	Return only alerts that have been generated before the given time.
selectHosts	query	Return a hosts property with data of hosts that triggered the action operation.
selectMediatypes	query	Return a mediatypes property with an array of the media types that were used for the message alert. See mediatype.get for restrictions based on user type.
selectUsers	query	Return a users property with an array of the users that the message was addressed to.
sortfield	string/array	Sort the result by the given properties. Possible values: alertid, clock, eventid, mediatypeid, sendto, status.
countOutput	boolean	These parameters being common for all get methods are described in the reference commentary .
editable	boolean	
excludeSearch	boolean	
filter	object	
limit	integer	
output	query	
preservekeys	boolean	
search	object	
searchByAny	boolean	
searchWildcardsEnabled	boolean	
sortorder	string/array	
startSearch	boolean	

Return values

(integer/array) Returns either:

- an array of objects;
- the count of retrieved objects, if the countOutput parameter has been used.

Examples

Retrieve alerts by action ID

Retrieve all alerts generated by action "3".

Request:

```
{
  "jsonrpc": "2.0",
  "method": "alert.get",
  "params": {
    "output": "extend",
    "actionids": "3"
  },
  "id": 1
}
```

Response:

```

{
  "jsonrpc": "2.0",
  "result": [
    {
      "alertid": "1",
      "actionid": "3",
      "eventid": "21243",
      "userid": "1",
      "clock": "1362128008",
      "mediatypeid": "1",
      "sendto": "support@company.com",
      "subject": "PROBLEM: Zabbix agent on Linux server is unreachable for 5 minutes: ",
      "message": "Trigger: Zabbix agent on Linux server is unreachable for 5 minutes: \nTrigger stat",
      "status": "0",
      "retries": "3",
      "error": "",
      "esc_step": "1",
      "alerttype": "0",
      "p_eventid": "0",
      "acknowledgeid": "0"
    }
  ],
  "id": 1
}

```

See also

- [Host](#)
- [Media type](#)
- [User](#)

Source

`CAAlert::get()` in `ui/include/classes/api/services/CAAlert.php`.

API info

This class is designed to retrieve meta information about the API.

Available methods:

- `apiinfo.version` - retrieve the version of Zabbix API

`apiinfo.version`

Description

`string apiinfo.version(array)`

This method allows to retrieve the version of the Zabbix API.

Attention:

This method is only available to unauthenticated users.

Parameters

(array) The method accepts an empty array.

Return values

(string) Returns the version of the Zabbix API.

Note:

Starting from Zabbix 2.0.4 the version of the API matches the version of Zabbix.

Examples

Retrieving the version of the API

Retrieve the version of the Zabbix API.

Request:

```
{
  "jsonrpc": "2.0",
  "method": "apiinfo.version",
  "params": [],
  "id": 1
}
```

Response:

```
{
  "jsonrpc": "2.0",
  "result": "7.4.0",
  "id": 1
}
```

Source

CAPInfo::version() in *ui/include/classes/api/services/CAPInfo.php*.

Audit log

This class is designed to work with audit log.

Object references:

- [Audit log](#)

Available methods:

- [auditlog.get](#) - retrieve audit log records

Audit log object

The following objects are directly related to the `auditlog` API.

Audit log

The audit log object contains information about user actions. It has the following properties.

Property	Type	Description
auditid	ID	ID of audit log entry. Generated using CUID algorithm.
userid	ID	Audit log entry author userid.
username	string	Audit log entry author username.
clock	timestamp	Audit log entry creation timestamp.
ip	string	Audit log entry author IP address.
action	integer	Audit log entry action.

Possible values:

- 0 - Add;
- 1 - Update;
- 2 - Delete;
- 4 - Logout;
- 7 - Execute;
- 8 - Login;
- 9 - Failed login;
- 10 - History clear;
- 11 - Config refresh;
- 12 - Push.

Property	Type	Description
resourcetype	integer	<p>Audit log entry resource type.</p> <p>Possible values:</p> <ul style="list-style-type: none"> 0 - User; 3 - Media type; 4 - Host; 5 - Action; 6 - Graph; 11 - User group; 13 - Trigger; 14 - Host group; 15 - Item; 16 - Image; 17 - Value map; 18 - Service; 19 - Map; 22 - Web scenario; 23 - Discovery rule; 25 - Script; 26 - Proxy; 27 - Maintenance; 28 - Regular expression; 29 - Macro; 30 - Template; 31 - Trigger prototype; 32 - Icon mapping; 33 - Dashboard; 34 - Event correlation; 35 - Graph prototype; 36 - Item prototype; 37 - Host prototype; 38 - Autoregistration; 39 - Module; 40 - Settings; 41 - Housekeeping; 42 - Authentication; 43 - Template dashboard; 44 - User role; 45 - API token; 46 - Scheduled report; 47 - High availability node; 48 - SLA; 49 - User directory; 50 - Template group; 51 - Connector; 52 - LLD rule; 53 - History.
resourceid	ID	Audit log entry resource identifier.
resourceName	string	Audit log entry resource human readable name.
recordsetid	ID	Audit log entry recordset ID. The audit log records created during the same operation will have the same recordset ID. Generated using CUID algorithm.

Property	Type	Description
details	text	<p>Audit log entry details. The details are stored as a JSON object, where each property name is a path to the property or nested object in which the change occurred, and where each value contains the data (in array format) about the change in this property or nested object.</p> <p>Possible value formats:</p> <p>["add"] - Nested object has been added;</p> <p>["add", "<value>"] - The property of the added object equals <value>;</p> <p>["update"] - Nested object has been updated;</p> <p>["update", "<new value>", "<old value>"] - The property of the updated object was changed from <old value> to <new value>;</p> <p>["delete"] - Nested object has been deleted.</p>

auditlog.get

Description

`integer/array auditlog.get(object parameters)`

The method allows to retrieve audit log records according to the given parameters.

Note:

This method is only available to *Super admin* user type. Permissions to call the method can be revoked in user role settings. See [User roles](#) for more information.

Parameters

(object) Parameters defining the desired output.

The method supports the following parameters.

Parameter	Type	Description
auditids	ID/array	Return only audit log with the given IDs.
userids	ID/array	Return only audit log that were created by the given users.
time_from	timestamp	Returns only audit log entries that have been created after or at the given time.
time_till	timestamp	Returns only audit log entries that have been created before or at the given time.
sortfield	string/array	Sort the result by the given properties.
countOutput	boolean	<p>Possible values: <code>auditid</code>, <code>userid</code>, <code>clock</code>.</p> <p>These parameters being common for all get methods are described in the reference commentary.</p>
excludeSearch	boolean	
filter	object	
limit	integer	
output	query	
preservekeys	boolean	
search	object	
searchByAny	boolean	
searchWildcardsEnabled	boolean	
sortorder	string/array	
startSearch	boolean	

Return values

(integer/array) Returns either:

- an array of objects;
- the count of retrieved objects, if the `countOutput` parameter has been used.

Examples

Retrieve audit log

Retrieve two latest audit log records.

Request:

```
{
  "jsonrpc": "2.0",
  "method": "auditlog.get",
  "params": {
    "output": "extend",
    "sortfield": "clock",
    "sortorder": "DESC",
    "limit": 2
  },
  "id": 1
}
```

Response:

```
{
  "jsonrpc": "2.0",
  "result": [
    {
      "auditid": "cksstgfam0001yhdcc41y20q2",
      "userid": "1",
      "username": "Admin",
      "clock": "1629975715",
      "ip": "127.0.0.1",
      "action": "1",
      "resourcetype": "0",
      "resourceid": "0",
      "resourcename": "Jim",
      "recordsetid": "cksstgfal0000yhdcso67ond1",
      "details": "{\"user.name\": [\"update\", \"Jim\", \"\"], \"user.medias[37]\": [\"add\"], \"user.medias[37].id\": [\"1\"]}"
    },
    {
      "auditid": "ckssofl0p0001yhdcqxclsg8r",
      "userid": "1",
      "username": "Admin",
      "clock": "1629967278",
      "ip": "127.0.0.1",
      "action": "0",
      "resourcetype": "0",
      "resourceid": "20",
      "resourcename": "John",
      "recordsetid": "ckssofl0p0000yhdcpxyo1jgo",
      "details": "{\"user.username\": [\"add\", \"John\"], \"user.userid\": [\"add\", \"20\"], \"user.userid.id\": [\"20\"]}"
    }
  ],
  "id": 1
}
```

See also

- [Audit log object](#)

Source

CAuditLog::get() in *ui/include/classes/api/services/CAuditLog.php*.

Authentication

This class is designed to work with authentication settings.

Object references:

- **Authentication**

Available methods:

- **authentication.get** - retrieve authentication settings
- **authentication.update** - update authentication settings

Authentication object

The following objects are directly related to the authentication API.

Authentication

The authentication object has the following properties.

Property	Type	Description
authentication_type	integer	Default authentication. Possible values: 0 - (default) Internal; 1 - LDAP.
http_auth_enabled	integer	HTTP authentication. Possible values: 0 - (default) Disabled; 1 - Enabled. Property behavior: - supported if \$ALLOW_HTTP_AUTH is enabled in the frontend configuration file (zabbix.conf.php).
http_login_form	integer	Default login form. Possible values: 0 - (default) Zabbix login form; 1 - HTTP login form. Property behavior: - supported if \$ALLOW_HTTP_AUTH is enabled in the frontend configuration file (zabbix.conf.php).
http_strip_domains	string	Domain name to remove. Property behavior: - supported if \$ALLOW_HTTP_AUTH is enabled in the frontend configuration file (zabbix.conf.php).
http_case_sensitive	integer	HTTP case sensitive login. Possible values: 0 - Off; 1 - (default) On. Property behavior: - supported if \$ALLOW_HTTP_AUTH is enabled in the frontend configuration file (zabbix.conf.php).
ldap_auth_enabled	integer	LDAP authentication. Possible values: 0 - (default) Disabled; 1 - Enabled.
ldap_case_sensitive	integer	LDAP case sensitive login. Possible values: 0 - Off; 1 - (default) On.

Property	Type	Description
ldap_userdirectoryid	ID	ID of the default user directory for LDAP authentication. Used for user groups with <code>gui_access</code> set to LDAP or System default.
saml_auth_enabled	integer	<p>Property behavior: - <i>required</i> if <code>ldap_auth_enabled</code> is set to "Enabled" SAML authentication.</p> <p>Possible values: 0 - (<i>default</i>) Disabled; 1 - Enabled.</p>
saml_case_sensitive	integer	<p>SAML case sensitive login.</p> <p>Possible values: 0 - Off; 1 - (<i>default</i>) On.</p>
passwd_min_length	integer	<p>Password minimal length requirement.</p> <p>Possible values range from 1 to 70.</p>
passwd_check_rules	integer	<p>Default: 8. Password checking rules.</p> <p>Possible bitmap values: 0 - Check password length; 1 - Check if password uses uppercase and lowercase Latin letters; 2 - Check if password uses digits; 4 - Check if password uses special characters; 8 - (<i>default</i>) Check if password is not in the list of commonly used passwords and does not contain derivations of word "Zabbix" or user's name, last name, or username.</p>
ldap_jit_status	integer	<p>This is a bitmask field; any sum of possible bitmap values is acceptable (for example, 15 for checking all rules). Status of LDAP provisioning.</p> <p>Possible values: 0 - Disabled for configured LDAP IdPs; 1 - Enabled for configured LDAP IdPs.</p>
saml_jit_status	integer	<p>Status of SAML provisioning.</p> <p>Possible values: 0 - Disabled for configured SAML IdPs; 1 - Enabled for configured SAML IdPs.</p>
jit_provision_interval	string	<p>Time interval between JIT provision requests for logged-in user. Accepts seconds and time unit with suffix with month and year support (3600s,60m,1h,1d,1M,1y). Minimum value: 1h.</p> <p>Default: 1h.</p>
disabled_usrgrpid	ID	<p>Available only for LDAP provisioning. ID of the user group to assign the deprovisioned user to. The user group must be disabled and cannot be enabled or deleted when configured.</p> <p>Property behavior: - <i>required</i> if <code>ldap_jit_status</code> is set to "Enabled for configured LDAP IdPs", or <code>saml_jit_status</code> is set to "Enabled for configured SAML IdPs"</p>

Property	Type	Description
mfa_status	integer	Multi-factor authentication. Possible values: 0 - Disabled (for all configured MFA methods); 1 - Enabled (for all configured MFA methods).
mfaid	ID	Default MFA method for user groups with MFA enabled. Property behavior: - <i>required</i> if mfa_status is set to "Enabled"

authentication.get

Description

object authentication.get(object parameters)

The method allows to retrieve authentication object according to the given parameters.

Note:

This method is only available to *Super admin* user type. Permissions to call the method can be revoked in user role settings. See **User roles** for more information.

Parameters

(object) Parameters defining the desired output.

The method supports only one parameter.

Parameter	Type	Description
output	query	This parameter being common for all get methods described in the reference commentary .

Return values

(object) Returns authentication object.

Examples

Request:

```
{
  "jsonrpc": "2.0",
  "method": "authentication.get",
  "params": {
    "output": "extend"
  },
  "id": 1
}
```

Response:

```
{
  "jsonrpc": "2.0",
  "result": {
    "authentication_type": "0",
    "http_auth_enabled": "0",
    "http_login_form": "0",
    "http_strip_domains": "",
    "http_case_sensitive": "1",
    "ldap_auth_enabled": "0",
    "ldap_case_sensitive": "1",
    "ldap_userdirectoryid": "0",
    "saml_auth_enabled": "0",
  }
}
```



```

        "saml_case_sensitive": "0",
        "passwd_min_length": "8",
        "passwd_check_rules": "15",
        "jit_provision_interval": "1h",
        "saml_jit_status": "0",
        "ldap_jit_status": "0",
        "disabled_usrgrp_id": "9",
        "mfa_status": "0",
        "mfa_id": "0"
    },
    "id": 1
}

```

Source

CAuthentication::get() in `ui/include/classes/api/services/CAuthentication.php`.

authentication.update

Description

object authentication.update(object authentication)

This method allows to update existing authentication settings.

Note:

This method is only available to *Super admin* user type. Permissions to call the method can be revoked in user role settings. See [User roles](#) for more information.

Parameters

(object) **Authentication properties** to be updated.

Return values

(array) Returns an array with the names of updated parameters.

Examples

Request:

```

{
  "jsonrpc": "2.0",
  "method": "authentication.update",
  "params": {
    "http_auth_enabled": 1,
    "http_case_sensitive": 0,
    "http_login_form": 1
  },
  "id": 1
}

```

Response:

```

{
  "jsonrpc": "2.0",
  "result": [
    "http_auth_enabled",
    "http_case_sensitive",
    "http_login_form"
  ],
  "id": 1
}

```

Source

CAuthentication::update() in `ui/include/classes/api/services/CAuthentication.php`.

Autoregistration

This class is designed to work with autoregistration.

Object references:

- [Autoregistration](#)

Available methods:

- [autoregistration.get](#) - retrieve autoregistration
- [autoregistration.update](#) - update autoregistration

Autoregistration object

The following objects are directly related to the `autoregistration` API.

Autoregistration

The autoregistration object has the following properties.

Property	Type	Description
<code>tls_accept</code>	integer	Type of allowed incoming connections for autoregistration. Possible values: 1 - allow unencrypted connections; 2 - allow TLS with PSK; 3 - allow both unencrypted and TLS with PSK connections.
<code>tls_psk_identity</code>	string	PSK identity; must be paired with only one PSK (across autoregistration , hosts , and proxies). Do not include sensitive information in the PSK identity, as it is sent unencrypted over the network to inform the receiver which PSK to use. Property behavior: - <i>write-only</i>
<code>tls_psk</code>	string	Pre-shared key (PSK); must be at least 32 hex digits. Property behavior: - <i>write-only</i>

`autoregistration.get`

Description

`object autoregistration.get(object parameters)`

The method allows to retrieve autoregistration object according to the given parameters.

Note:

This method is only available to *Super admin* user type. Permissions to call the method can be revoked in user role settings. See [User roles](#) for more information.

Parameters

(object) Parameters defining the desired output.

The method supports only one parameter.

Parameter	Type	Description
<code>output</code>	query	This parameter being common for all get methods described in the reference commentary .

Return values

(object) Returns autoregistration object.

Examples

Request:

```
{
  "jsonrpc": "2.0",
  "method": "autoregistration.get",
  "params": {
    "output": "extend"
  },
  "id": 1
}
```

Response:

```
{
  "jsonrpc": "2.0",
  "result": {
    "tls_accept": "3"
  },
  "id": 1
}
```

Source

CAutoregistration::get() in *ui/include/classes/api/services/CAutoregistration.php*.

autoregistration.update

Description

object autoregistration.update(object autoregistration)

This method allows to update existing autoregistration.

Note:

This method is only available to *Super admin* user type. Permissions to call the method can be revoked in user role settings. See [User roles](#) for more information.

Parameters

(object) **Autoregistration properties** to be updated.

Return values

(boolean) Returns boolean true as result on successful update.

Examples

Request:

```
{
  "jsonrpc": "2.0",
  "method": "autoregistration.update",
  "params": {
    "tls_accept": "3",
    "tls_psk_identity": "PSK 001",
    "tls_psk": "11111595725ac58dd977beef14b97461a7c1045b9a1c923453302c5473193478"
  },
  "id": 1
}
```

Response:

```
{
  "jsonrpc": "2.0",
  "result": true,
}
```

```
"id": 1  
}
```

Source

CAutoregistration::update() in *ui/include/classes/api/services/CAutoregistration.php*.

Configuration

This class is designed to export and import Zabbix configuration data.

Available methods:

- [configuration.export](#) - export configuration data
- [configuration.import](#) - import configuration data
- [configuration.importcompare](#) - compare import file with current system elements

configuration.export

Description

string `configuration.export(object parameters)`

This method allows to export configuration data as a serialized string.

Note:

This method is available to users of any type. Permissions to call the method can be revoked in user role settings. See [User roles](#) for more information.

Parameters

(object) Parameters defining the objects to be exported and the format to use.

Parameter	Type	Description
format	string	Format in which the data must be exported. Possible values: yaml - YAML; xml - XML; json - JSON; raw - unprocessed PHP array.
prettyprint	boolean	Parameter behavior: - <i>required</i> Make the output more human readable by adding indentation.
options	object	Possible values: true - add indentation; false - (<i>default</i>) do not add indentation. Objects to be exported. The options object has the following parameters: host_groups - (array) IDs of host groups to export; hosts - (array) IDs of hosts to export; images - (array) IDs of images to export; maps - (array) IDs of maps to export; mediaTypes - (array) IDs of media types to export; template_groups - (array) IDs of template groups to export; templates - (array) IDs of templates to export. Parameter behavior: - <i>required</i>

Return values

(string) Returns a serialized string containing the requested configuration data.

Examples

Exporting a template

Export the configuration of template "10571" as an XML string.

Request:

```
{
  "jsonrpc": "2.0",
  "method": "configuration.export",
  "params": {
    "options": {
      "templates": [
        "10571"
      ]
    },
    "format": "xml"
  },
  "id": 1
}
```

Response:

```
{
  "jsonrpc": "2.0",
  "result": "<?xml version='1.0' encoding='UTF-8'?>\n<zabbix_export><version>7.4</version><template_
  "id": 1
}
```

Source

CConfiguration::export() in `ui/include/classes/api/services/CConfiguration.php`.

configuration.import

Description

boolean configuration.import(object parameters)

This method allows to import configuration data from a serialized string.

Note:

This method is available to users of any type. Permissions to call the method can be revoked in user role settings. See [User roles](#) for more information.

Parameters

(object) Parameters containing the data to import and rules how the data should be handled.

Parameter	Type	Description
format	string	Format of the serialized string. Possible values: yaml - YAML; xml - XML; json - JSON. Parameter behavior: - <i>required</i>
source	string	Serialized string containing the configuration data. Parameter behavior: - <i>required</i>

Parameter	Type	Description
rules	object	Rules on how new and existing objects should be imported. The rules parameter is described in detail in the table below. Parameter behavior: - <i>required</i>

Note:

If no rules are given, the configuration will not be updated.

The rules object supports the following parameters.

Parameter	Type	Description
discoveryRules	object	Rules on how to import LLD rules. Supported parameters: createMissing - (boolean) if set to true, new LLD rules will be created; default: false; updateExisting - (boolean) if set to true, existing LLD rules will be updated; default: false; deleteMissing - (boolean) if set to true, LLD rules not present in the imported data will be deleted from the database; default: false.
graphs	object	Rules on how to import graphs. Supported parameters: createMissing - (boolean) if set to true, new graphs will be created; default: false; updateExisting - (boolean) if set to true, existing graphs will be updated; default: false; deleteMissing - (boolean) if set to true, graphs not present in the imported data will be deleted from the database; default: false.
host_groups	object	Rules on how to import host groups. Supported parameters: createMissing - (boolean) if set to true, new host groups will be created; default: false; updateExisting - (boolean) if set to true, existing host groups will be updated; default: false.
template_groups	object	Rules on how to import template groups. Supported parameters: createMissing - (boolean) if set to true, new template groups will be created; default: false; updateExisting - (boolean) if set to true, existing template groups will be updated; default: false.
hosts	object	Rules on how to import hosts. Supported parameters: createMissing - (boolean) if set to true, new hosts will be created; default: false; updateExisting - (boolean) if set to true, existing hosts will be updated; default: false.

Parameter	Type	Description
httptests	object	<p>Rules on how to import web scenarios.</p> <p>Supported parameters: <code>createMissing</code> - (boolean) if set to true, new web scenarios will be created; default: false; <code>updateExisting</code> - (boolean) if set to true, existing web scenarios will be updated; default: false; <code>deleteMissing</code> - (boolean) if set to true, web scenarios not present in the imported data will be deleted from the database; default: false.</p>
images	object	<p>Rules on how to import images.</p> <p>Supported parameters: <code>createMissing</code> - (boolean) if set to true, new images will be created; default: false; <code>updateExisting</code> - (boolean) if set to true, existing images will be updated; default: false.</p>
items	object	<p>Rules on how to import items.</p> <p>Supported parameters: <code>createMissing</code> - (boolean) if set to true, new items will be created; default: false; <code>updateExisting</code> - (boolean) if set to true, existing items will be updated; default: false; <code>deleteMissing</code> - (boolean) if set to true, items not present in the imported data will be deleted from the database; default: false.</p>
maps	object	<p>Rules on how to import maps.</p> <p>Supported parameters: <code>createMissing</code> - (boolean) if set to true, new maps will be created; default: false; <code>updateExisting</code> - (boolean) if set to true, existing maps will be updated; default: false.</p>
mediaTypes	object	<p>Rules on how to import media types.</p> <p>Supported parameters: <code>createMissing</code> - (boolean) if set to true, new media types will be created; default: false; <code>updateExisting</code> - (boolean) if set to true, existing media types will be updated; default: false.</p>
templateLinkage	object	<p>Rules on how to import template links.</p> <p>Supported parameters: <code>createMissing</code> - (boolean) if set to true, templates that are not linked to the host or template being imported, but are present in the imported data, will be linked; default: false; <code>deleteMissing</code> - (boolean) if set to true, templates that are linked to the host or template being imported, but are not present in the imported data, will be unlinked without removing entities (items, triggers, etc.) inherited from the unlinked templates; default: false.</p>
templates	object	<p>Rules on how to import templates.</p> <p>Supported parameters: <code>createMissing</code> - (boolean) if set to true, new templates will be created; default: false; <code>updateExisting</code> - (boolean) if set to true, existing templates will be updated; default: false.</p>

Parameter	Type	Description
templateDashboards	object	<p>Rules on how to import template dashboards.</p> <p>Supported parameters:</p> <ul style="list-style-type: none"> createMissing - (boolean) if set to true, new template dashboards will be created; default: false; updateExisting - (boolean) if set to true, existing template dashboards will be updated; default: false; deleteMissing - (boolean) if set to true, template dashboards not present in the imported data will be deleted from the database; default: false.
triggers	object	<p>Rules on how to import triggers.</p> <p>Supported parameters:</p> <ul style="list-style-type: none"> createMissing - (boolean) if set to true, new triggers will be created; default: false; updateExisting - (boolean) if set to true, existing triggers will be updated; default: false; deleteMissing - (boolean) if set to true, triggers not present in the imported data will be deleted from the database; default: false.
valueMaps	object	<p>Rules on how to import host or template value maps.</p> <p>Supported parameters:</p> <ul style="list-style-type: none"> createMissing - (boolean) if set to true, new value maps will be created; default: false; updateExisting - (boolean) if set to true, existing value maps will be updated; default: false; deleteMissing - (boolean) if set to true, value maps not present in the imported data will be deleted from the database; default: false.

Return values

(boolean) Returns true if importing has been successful.

Examples

Importing a template

Import the template configuration contained in the XML string. If any items or triggers in the XML string are missing, they will be deleted from the database, and everything else will be left unchanged.

Request:

```
{
  "jsonrpc": "2.0",
  "method": "configuration.import",
  "params": {
    "format": "xml",
    "rules": {
      "templates": {
        "createMissing": true,
        "updateExisting": true
      },
      "items": {
        "createMissing": true,
        "updateExisting": true,
        "deleteMissing": true
      },
      "triggers": {
        "createMissing": true,
        "updateExisting": true,
        "deleteMissing": true
      },
      "valueMaps": {
        "createMissing": true,
```



```

        "updateExisting": false
    }
},
"source": "<?xml version=\"1.0\" encoding=\"UTF-8\"?>\n<zabbix_export><version>7.4</version><templ
},
"id": 1
}

```

Response:

```

{
  "jsonrpc": "2.0",
  "result": true,
  "id": 1
}

```

Source

CConfiguration::import() in `ui/include/classes/api/services/CConfiguration.php`.

configuration.importcompare

Description

array configuration.importcompare(object parameters)

This method allows to compare import file with current system elements and shows what will be changed if this import file will be imported.

Note:

This method is available to users of any type. Permissions to call the method can be revoked in user role settings. See [User roles](#) for more information.

Parameters

(object) Parameters containing the possible data to import and rules how the data should be handled.

Parameter	Type	Description
format	string	Format of the serialized string. Possible values: yaml - YAML; xml - XML; json - JSON.
source	string	Parameter behavior: - <i>required</i> Serialized string containing the configuration data.
rules	object	Parameter behavior: - <i>required</i> Rules on how new and existing objects should be compared. The rules parameter is described in detail in the table below. Parameter behavior: - <i>required</i>

Note:

If no rules are given, there will be nothing to update and result will be empty.

Note:

Comparison will be done only for host groups and templates. Triggers and graphs will be compared only for imported templates, any other will be considered as "new".

The rules object supports the following parameters.

Parameter	Type	Description
discoveryRules	object	Rules on how to import LLD rules. Supported parameters: createMissing - (boolean) if set to true, new LLD rules will be created; default: false; updateExisting - (boolean) if set to true, existing LLD rules will be updated; default: false; deleteMissing - (boolean) if set to true, LLD rules not present in the imported data will be deleted from the database; default: false.
graphs	object	Rules on how to import graphs. Supported parameters: createMissing - (boolean) if set to true, new graphs will be created; default: false; updateExisting - (boolean) if set to true, existing graphs will be updated; default: false; deleteMissing - (boolean) if set to true, graphs not present in the imported data will be deleted from the database; default: false.
host_groups	object	Rules on how to import host groups. Supported parameters: createMissing - (boolean) if set to true, new host groups will be created; default: false; updateExisting - (boolean) if set to true, existing host groups will be updated; default: false.
template_groups	object	Rules on how to import template groups. Supported parameters: createMissing - (boolean) if set to true, new template groups will be created; default: false; updateExisting - (boolean) if set to true, existing template groups will be updated; default: false.
hosts	object	Rules on how to import hosts. Supported parameters: createMissing - (boolean) if set to true, new hosts will be created; default: false; updateExisting - (boolean) if set to true, existing hosts will be updated; default: false.
httptests	object	This parameter will make no difference to the output. It is allowed only for consistency with <code>configuration.import</code> . Rules on how to import web scenarios. Supported parameters: createMissing - (boolean) if set to true, new web scenarios will be created; default: false; updateExisting - (boolean) if set to true, existing web scenarios will be updated; default: false; deleteMissing - (boolean) if set to true, web scenarios not present in the imported data will be deleted from the database; default: false.

Parameter	Type	Description
images	object	<p>Rules on how to import images.</p> <p>Supported parameters: <code>createMissing</code> - (boolean) if set to true, new images will be created; default: false; <code>updateExisting</code> - (boolean) if set to true, existing images will be updated; default: false.</p> <p>This parameter will make no difference to the output. It is allowed only for consistency with <code>configuration.import</code>.</p>
items	object	<p>Rules on how to import items.</p> <p>Supported parameters: <code>createMissing</code> - (boolean) if set to true, new items will be created; default: false; <code>updateExisting</code> - (boolean) if set to true, existing items will be updated; default: false; <code>deleteMissing</code> - (boolean) if set to true, items not present in the imported data will be deleted from the database; default: false.</p>
maps	object	<p>Rules on how to import maps.</p> <p>Supported parameters: <code>createMissing</code> - (boolean) if set to true, new maps will be created; default: false; <code>updateExisting</code> - (boolean) if set to true, existing maps will be updated; default: false.</p> <p>This parameter will make no difference to the output. It is allowed only for consistency with <code>configuration.import</code>.</p>
mediaTypes	object	<p>Rules on how to import media types.</p> <p>Supported parameters: <code>createMissing</code> - (boolean) if set to true, new media types will be created; default: false; <code>updateExisting</code> - (boolean) if set to true, existing media types will be updated; default: false.</p> <p>This parameter will make no difference to the output. It is allowed only for consistency with <code>configuration.import</code>.</p>
templateLinkage	object	<p>Rules on how to import template links.</p> <p>Supported parameters: <code>createMissing</code> - (boolean) if set to true, templates that are not linked to the host or template being imported, but are present in the imported data, will be linked; default: false; <code>deleteMissing</code> - (boolean) if set to true, templates that are linked to the host or template being imported, but are not present in the imported data, will be unlinked without removing entities (items, triggers, etc.) inherited from the unlinked templates; default: false.</p>
templates	object	<p>Rules on how to import templates.</p> <p>Supported parameters: <code>createMissing</code> - (boolean) if set to true, new templates will be created; default: false; <code>updateExisting</code> - (boolean) if set to true, existing templates will be updated; default: false.</p>

Parameter	Type	Description
templateDashboards	object	<p>Rules on how to import template dashboards.</p> <p>Supported parameters: createMissing - (boolean) if set to true, new template dashboards will be created; default: false; updateExisting - (boolean) if set to true, existing template dashboards will be updated; default: false; deleteMissing - (boolean) if set to true, template dashboards not present in the imported data will be deleted from the database; default: false.</p>
triggers	object	<p>Rules on how to import triggers.</p> <p>Supported parameters: createMissing - (boolean) if set to true, new triggers will be created; default: false; updateExisting - (boolean) if set to true, existing triggers will be updated; default: false; deleteMissing - (boolean) if set to true, triggers not present in the imported data will be deleted from the database; default: false.</p>
valueMaps	object	<p>Rules on how to import host or template value maps.</p> <p>Supported parameters: createMissing - (boolean) if set to true, new value maps will be created; default: false; updateExisting - (boolean) if set to true, existing value maps will be updated; default: false; deleteMissing - (boolean) if set to true, value maps not present in the imported data will be deleted from the database; default: false.</p>

Return values

(array) Returns an array with changes in configuration, that will be made.

Examples

Comparing the import of a template

Compare the template contained in the XML string to the current system elements, and show what will be changed if this template will be imported.

Request:

```
{
  "jsonrpc": "2.0",
  "method": "configuration.importcompare",
  "params": {
    "format": "xml",
    "rules": {
      "discoveryRules": {
        "createMissing": true,
        "updateExisting": true,
        "deleteMissing": true
      },
      "graphs": {
        "createMissing": true,
        "updateExisting": true,
        "deleteMissing": true
      },
      "host_groups": {
        "createMissing": true,
        "updateExisting": true
      },
      "template_groups": {
        "createMissing": true,
```

```

        "updateExisting": true
    },
    "httptests": {
        "createMissing": true,
        "updateExisting": true,
        "deleteMissing": true
    },
    "items": {
        "createMissing": true,
        "updateExisting": true,
        "deleteMissing": true
    },
    "templateLinkage": {
        "createMissing": true,
        "deleteMissing": true
    },
    "templates": {
        "createMissing": true,
        "updateExisting": true
    },
    "templateDashboards": {
        "createMissing": true,
        "updateExisting": true,
        "deleteMissing": true
    },
    "triggers": {
        "createMissing": true,
        "updateExisting": true,
        "deleteMissing": true
    },
    "valueMaps": {
        "createMissing": true,
        "updateExisting": true,
        "deleteMissing": true
    }
},
"source": "<?xml version=\"1.0\" encoding=\"UTF-8\"?>\n<zabbix_export><version>7.4</version><templ
",
"id": 1
}

```

Response:

```

{
  "jsonrpc": "2.0",
  "result": {
    "templates": {
      "updated": [
        {
          "before": {
            "uuid": "5aef0444a82a4d8cb7a95dc4c0c85330",
            "template": "New template",
            "name": "New template",
            "groups": [
              {
                "name": "Templates"
              }
            ]
          },
          "after": {
            "uuid": "5aef0444a82a4d8cb7a95dc4c0c85330",
            "template": "New template",
            "name": "New template",

```

```

    "groups": [
      {
        "name": "Templates"
      }
    ],
  },
  "items": {
    "added": [
      {
        "after": {
          "uuid": "648006da5971424ead0c47ddb1ea2e",
          "name": "CPU utilization",
          "key": "system.cpu.util",
          "value_type": "FLOAT",
          "units": "%"
        },
        "triggers": {
          "added": [
            {
              "after": {
                "uuid": "736225012c534ec480c2a66a91322ce0",
                "expression": "avg(/New template/system.cpu.util,3m)>70",
                "name": "CPU utilization too high on 'New host' for 3 minutes",
                "priority": "WARNING"
              }
            }
          ]
        }
      }
    ],
    "removed": [
      {
        "before": {
          "uuid": "6805d4c39a624a8bab2cc8ab63df1ab3",
          "name": "CPU load",
          "key": "system.cpu.load",
          "value_type": "FLOAT"
        },
        "triggers": {
          "removed": [
            {
              "before": {
                "uuid": "ab4c2526c2bc42e48a633082255ebcb3",
                "expression": "avg(/New template/system.cpu.load,3m)>2",
                "name": "CPU load too high on 'New host' for 3 minutes",
                "priority": "WARNING"
              }
            }
          ]
        }
      }
    ],
    "updated": [
      {
        "before": {
          "uuid": "7f1e6f1e48aa4a128e5b6a958a5d11c3",
          "name": "Zabbix agent ping",
          "key": "agent.ping"
        },
        "after": {
          "uuid": "7f1e6f1e48aa4a128e5b6a958a5d11c3",
          "name": "Zabbix agent ping",

```

```

    "key": "agent.ping",
    "delay": "3m"
  }
}
]
},
  "id": 1
}
}

```

Source

CConfiguration::importcompare() in *ui/include/classes/api/services/CConfiguration.php*.

Connector

This class is designed to work with connectors.

Object references:

- [Connector](#)
- [Tag filter](#)

Available methods:

- [connector.create](#) - create new connectors
- [connector.delete](#) - delete connectors
- [connector.get](#) - retrieve connectors
- [connector.update](#) - update connectors

Connector object

The following objects are directly related to the connector API.

Connector

The connector object has the following properties.

Property	Type	Description
connectorid	ID	ID of the connector.
name	string	<p>Property behavior:</p> <ul style="list-style-type: none"> - <i>read-only</i> - <i>required</i> for update operations Name of the connector.
url	string	<p>Property behavior:</p> <ul style="list-style-type: none"> - <i>required</i> for create operations Endpoint URL, that is, URL of the receiver. User macros are supported.
protocol	integer	<p>Property behavior:</p> <ul style="list-style-type: none"> - <i>required</i> for create operations Communication protocol.
data_type	integer	<p>Possible values:</p> <ul style="list-style-type: none"> 0 - (<i>default</i>) Zabbix Streaming Protocol v1.0. Data type. <p>Possible values:</p> <ul style="list-style-type: none"> 0 - (<i>default</i>) Item values; 1 - Events.

Property	Type	Description
item_value_type	integer	<p>A sum of item value types to be sent.</p> <p>Possible values: 1 - Numeric (float); 2 - Character; 4 - Log; 8 - Numeric (unsigned); 10 - Text; 20 - Binary.</p> <p>Default: 31 - All item types (except binary).</p> <p>Property behavior: - <i>supported</i> if data_type is set to "Item values".</p>
max_records	integer	<p>Maximum number of events or items that can be sent within one message.</p> <p>Possible values: 0-2147483647 (max value of 32-bit signed integer).</p> <p>Default: 0 - Unlimited.</p>
max_senders	integer	<p>Number of sender processes to run for this connector.</p> <p>Possible values: 1-100.</p>
max_attempts	integer	<p>Default: 1. Number of attempts.</p> <p>Possible values: 1-5.</p>
attempt_interval	string	<p>Default: 1. The interval between retry attempts. Accepts seconds.</p> <p>Possible values: 0s-10s.</p> <p>Default: 5s.</p> <p>Property behavior: - <i>supported</i> if max_attempts is greater than 1.</p>
timeout	string	<p>Timeout. Time suffixes are supported (e.g., 30s, 1m). User macros are supported.</p> <p>Possible values: 1s-60s.</p>
http_proxy	string	<p>Default: 5s. HTTP(S) proxy connection string given as <code>[protocol]://[username[:password]@]proxy.example.com[:port]</code>.</p>
authtype	integer	<p>User macros are supported. HTTP authentication method.</p> <p>Possible values: 0 - (default) None; 1 - Basic; 2 - NTLM; 3 - Kerberos; 4 - Digest; 5 - Bearer.</p>

Property	Type	Description
username	string	User name. User macros are supported.
password	string	Property behavior: - <i>supported</i> if authntype is set to "Basic", "NTLM", "Kerberos", or "Digest" Password. User macros are supported.
token	string	Property behavior: - <i>supported</i> if authntype is set to "Basic", "NTLM", "Kerberos", or "Digest" Bearer token. User macros are supported.
verify_peer	integer	Property behavior: - <i>required</i> if authntype is set to "Bearer" Whether to validate that the host's certificate is authentic.
verify_host	integer	Possible values: 0 - Do not validate; 1 - (<i>default</i>) Validate. Whether to validate that the host name for the connection matches the one in the host's certificate.
ssl_cert_file	string	Possible values: 0 - Do not validate; 1 - (<i>default</i>) Validate. Public SSL Key file path. User macros are supported.
ssl_key_file	string	Private SSL Key file path. User macros are supported.
ssl_key_password	string	Password for SSL Key file. User macros are supported.
description	text	Description of the connector.
status	integer	Whether the connector is enabled.
tags_evaltype	integer	Possible values: 0 - Disabled; 1 - (<i>default</i>) Enabled. Tag evaluation method.
		Possible values: 0 - (<i>default</i>) And/Or; 2 - Or.

Tag filter

Tag filter allows to export only matching item values or events. If not set then everything will be exported. The tag filter object has the following properties.

Property	Type	Description
tag	string	Tag name.
		Property behavior: - <i>required</i>

Property	Type	Description
operator	integer	Condition operator. Possible values: 0 - (default) Equals; 1 - Does not equal; 2 - Contains; 3 - Does not contain; 12 - Exists;
value	string	1 - Does not exist. Tag value.

connector.create

Description

object connector.create(object/array connectors)

This method allows to create new connector objects.

Note:

This method is only available to *Super admin* user type. Permissions to call the method can be revoked in user role settings. See [User roles](#) for more information.

Parameters

(object/array) Connector objects to create.

Additionally to the [standard connector properties](#), the method accepts the following parameters.

Parameter	Type	Description
tags	array	Connector tag filter .

Return values

(object) Returns an object containing the IDs of the created connectors under the `connectorids` property. The order of the returned IDs matches the order of the passed connectors.

Examples

Creating a connector

Create a connector to export trigger events with a tag filter. HTTP authentication will be performed using Bearer token.

Request:

```
{
  "jsonrpc": "2.0",
  "method": "connector.create",
  "params": [
    {
      "name": "Export of events",
      "data_type": 1,
      "url": "${DATA_EXPORT_URL}",
      "authtype": 5,
      "token": "${DATA_EXPORT_BEARER_TOKEN}",
      "tags": [
        {
          "tag": "service",
          "operator": 0,
          "value": "mysqld"
        }
      ]
    }
  ]
}
```

```
    ],  
    "id": 1  
  }  
}
```

Response:

```
{  
  "jsonrpc": "2.0",  
  "result": {  
    "connectorid": [  
      "3"  
    ]  
  },  
  "id": 1  
}
```

Source

CConnector::create() in *ui/include/classes/api/services/CConnector.php*.

connector.delete

Description

object connector.delete(array connectorids)

This method allows to delete connector entries.

Note:

This method is only available to *Super admin* user type. Permissions to call the method can be revoked in user role settings. See [User roles](#) for more information.

Parameters

(array) IDs of the connectors to delete.

Return values

(object) Returns an object containing the IDs of the deleted connectors under the `connectorids` property.

Examples

Deleting multiple connectors

Delete two connector entries.

Request:

```
{  
  "jsonrpc": "2.0",  
  "method": "connector.delete",  
  "params": [  
    3,  
    5  
  ],  
  "id": 1  
}
```

Response:

```
{  
  "jsonrpc": "2.0",  
  "result": {  
    "connectorids": [  
      "3",  
      "5"  
    ]  
  },  
}
```

```
"id": 1
}
```

Source

CConnector::delete() in *ui/include/classes/api/services/CConnector.php*.

connector.get

Description

integer/array connector.get(object parameters)

The method allows to retrieve connector objects according to the given parameters.

Note:

This method is only available to *Super admin* user type. Permissions to call the method can be revoked in user role settings. See [User roles](#) for more information.

Parameters

(object) Parameters defining the desired output.

The method supports the following parameters.

Parameter	Type	Description
connectorids	ID/array	Return only connectors with the given IDs.
selectTags	query	Return a tags property with connector tag filter .
sortfield	string/array	Supports count. Sort the result by the given properties.
countOutput	boolean	Possible values: connectorid, name, data_type, status. These parameters being common for all get methods are described in detail in the reference commentary .
excludeSearch	boolean	
filter	object	
limit	integer	
output	query	
preservekeys	boolean	
search	object	
searchByAny	boolean	
searchWildcardsEnabled	boolean	
sortorder	string/array	
startSearch	boolean	

Return values

(integer/array) Returns either:

- an array of objects;
- the count of retrieved objects, if the `countOutput` parameter has been used.

Examples

Retrieving all connectors

Retrieve all data about all connectors and their properties.

Request:

```
{
  "jsonrpc": "2.0",
  "method": "connector.get",
  "params": {
    "output": "extend",
    "selectTags": ["tag", "operator", "value"],
  }
}
```

```
    "preservekeys": true
  },
  "id": 1
}
```

Response:

```
{
  "jsonrpc": "2.0",
  "result": [
    {
      "connectorid": "1",
      "name": "Export of item values",
      "protocol": "0",
      "data_type": "0",
      "url": "${DATA_EXPORT_VALUES_URL}",
      "item_value_type": "31",
      "authtype": "4",
      "username": "${DATA_EXPORT_VALUES_USERNAME}",
      "password": "${DATA_EXPORT_VALUES_PASSWORD}",
      "token": "",
      "max_records": "0",
      "max_senders": "4",
      "max_attempts": "2",
      "attempt_interval": "10s",
      "timeout": "10s",
      "http_proxy": "${DATA_EXPORT_VALUES_PROXY}",
      "verify_peer": "1",
      "verify_host": "1",
      "ssl_cert_file": "${DATA_EXPORT_VALUES_SSL_CERT_FILE}",
      "ssl_key_file": "${DATA_EXPORT_VALUES_SSL_KEY_FILE}",
      "ssl_key_password": "",
      "description": "",
      "status": "1",
      "tags_evaltype": "0",
      "tags": [
        {
          "tag": "component",
          "operator": "0",
          "value": "memory"
        }
      ]
    },
    {
      "connectorid": "2",
      "name": "Export of events",
      "protocol": "0",
      "data_type": "1",
      "url": "${DATA_EXPORT_EVENTS_URL}",
      "item_value_type": "31",
      "authtype": "5",
      "username": "",
      "password": "",
      "token": "${DATA_EXPORT_EVENTS_BEARER_TOKEN}",
      "max_records": "0",
      "max_senders": "2",
      "max_attempts": "1",
      "attempt_interval": "5s",
      "timeout": "5s",
      "http_proxy": "",
      "verify_peer": "1",
      "verify_host": "1",
      "ssl_cert_file": "",

```

```

        "ssl_key_file": "",
        "ssl_key_password": "",
        "description": "",
        "status": "1",
        "tags_evaltype": "0",
        "tags": [
            {
                "tag": "scope",
                "operator": "0",
                "value": "performance"
            }
        ]
    },
    "id": 1
}

```

Source

CConnector::get() in `ui/include/classes/api/services/CConnector.php`.

connector.update

Description

object connector.update(object/array connectors)

This method allows to update existing connectors.

Note:

This method is only available to *Super admin* user type. Permissions to call the method can be revoked in user role settings. See [User roles](#) for more information.

Parameters

(object/array) Connector properties to be updated.

The `connectorid` property must be defined for each connector, all other properties are optional. Only the passed properties will be updated, all others will remain unchanged.

Additionally to the [standard connector properties](#), the method accepts the following parameters.

Parameter	Type	Description
tags	array	Connector tag filter to replace the current tag filter.

Return values

(object) Returns an object containing the IDs of the updated connectors under the `connectorids` property.

Examples

Changing HTTP authentication type

Change HTTP authentication type to Bearer for connector with ID "3".

Request:

```

{
  "jsonrpc": "2.0",
  "method": "connector.update",
  "params": {
    "connectorid": 3,
    "authtype": 5,
    "token": "{$DATA_EXPORT_BEARER_TOKEN}"
  },
  "id": 1
}

```

Response:

```
{
  "jsonrpc": "2.0",
  "result": {
    "connectorids": [
      "3"
    ]
  },
  "id": 1
}
```

Updating tag filter

Change tag filter for connector with ID "5".

Request:

```
{
  "jsonrpc": "2.0",
  "method": "connector.update",
  "params": [
    {
      "connectorid": 5,
      "tags_evaltype": 2,
      "tags": [
        {
          "tag": "service",
          "operator": 0,
          "value": "mysqld"
        },
        {
          "tag": "error",
          "operator": 12,
          "value": ""
        }
      ]
    }
  ],
  "id": 1
}
```

Response:

```
{
  "jsonrpc": "2.0",
  "result": {
    "connectorids": [
      "5"
    ]
  },
  "id": 1
}
```

Source

CConnector::update() in *ui/include/classes/api/services/CConnector.php*.

Correlation

This class is designed to work with correlations.

Object references:

- [Correlation](#)
- [Correlation operation](#)

- [Correlation filter](#)
- [Correlation filter condition](#)

Available methods:

- [correlation.create](#) - create new correlations
- [correlation.delete](#) - delete correlations
- [correlation.get](#) - retrieve correlations
- [correlation.update](#) - update correlations

Correlation object

The following objects are directly related to the `correlation` API.

Correlation

The correlation object has the following properties.

Property	Type	Description
<code>correlationid</code>	ID	ID of the correlation.
<code>name</code>	string	Name of the correlation. Property behavior: - <i>read-only</i> - <i>required</i> for update operations
<code>description</code>	string	Description of the correlation. Property behavior: - <i>required</i> for create operations
<code>status</code>	integer	Whether the correlation is enabled or disabled. Possible values: 0 - (<i>default</i>) enabled; 1 - disabled.

Correlation operation

The correlation operation object defines an operation that will be performed when a correlation is executed. It has the following properties.

Property	Type	Description
<code>type</code>	integer	Type of operation. Possible values: 0 - close old events; 1 - close new event. Property behavior: - <i>required</i>

Correlation filter

The correlation filter object defines a set of conditions that must be met to perform the configured correlation operations. It has the following properties.

Property	Type	Description
conditions	array	Set of filter conditions to use for filtering results. The conditions will be sorted in the order of their placement in the formula.
evaltype	integer	<p>Property behavior: - <i>required</i></p> <p>Filter condition evaluation method.</p> <p>Possible values: 0 - and/or; 1 - and; 2 - or; 3 - custom expression.</p>
eval_formula	string	<p>Property behavior: - <i>required</i></p> <p>Generated expression that will be used for evaluating filter conditions. The expression contains IDs that reference specific filter conditions by its <code>formulaid</code>. The value of <code>eval_formula</code> is equal to the value of <code>formula</code> for filters with a custom expression.</p>
formula	string	<p>Property behavior: - <i>read-only</i></p> <p>User-defined expression to be used for evaluating conditions of filters with a custom expression. The expression must contain IDs that reference specific filter conditions by its <code>formulaid</code>. The IDs used in the expression must exactly match the ones defined in the filter conditions: no condition can remain unused or omitted.</p> <p>Property behavior: - <i>required</i> if <code>evaltype</code> is set to "custom expression"</p>

Correlation filter condition

The correlation filter condition object defines a specific condition that must be checked before running the correlation operations.

Property	Type	Description
type	integer	<p>Type of condition.</p> <p>Possible values: 0 - old event tag; 1 - new event tag; 2 - new event host group; 3 - event tag pair; 4 - old event tag value; 5 - new event tag value.</p>
tag	string	<p>Property behavior: - <i>required</i></p> <p>Event tag (old or new).</p> <p>Property behavior: - <i>required</i> if <code>type</code> is set to "old event tag", "new event tag", "old event tag value", or "new event tag value"</p>
groupid	ID	<p>ID of the host group.</p> <p>Property behavior: - <i>required</i> if <code>type</code> is set to "new event host group"</p>

Property	Type	Description
oldtag	string	Old event tag.
newtag	string	<p>Property behavior:</p> <p>- <i>required</i> if type is set to "event tag pair"</p> <p>Old event tag.</p>
value	string	<p>Property behavior:</p> <p>- <i>required</i> if type is set to "event tag pair"</p> <p>Event tag (old or new) value.</p>
formulaid	string	<p>Property behavior:</p> <p>- <i>required</i> if type is set to "old event tag value" or "new event tag value"</p> <p>Arbitrary unique ID that is used to reference the condition from a custom expression. Can only contain capital-case letters. The ID must be defined by the user when modifying filter conditions, but will be generated anew when requesting them afterward.</p>
operator	integer	<p>Condition operator.</p> <p>Property behavior:</p> <p>- <i>required</i> if type is set to "new event host group", "old event tag value", or "new event tag value"</p>

Note:

To better understand how to use filters with various types of expressions, see examples on the [correlation.get](#) and [correlation.create](#) method pages.

The following operators and values are supported for each condition type.

Condition	Condition name	Supported operators	Expected value
2	Host group	=, <>	Host group ID.
4	Old event tag value	=, <>, like, not like	string
5	New event tag value	=, <>, like, not like	string

correlation.create

Description

object correlation.create(object/array correlations)

This method allows to create new correlations.

Note:

This method is only available to *Super admin* user type. Permissions to call the method can be revoked in user role settings. See [User roles](#) for more information.

Parameters

(object/array) Correlations to create.

Additionally to the [standard correlation properties](#), the method accepts the following parameters.

Parameter	Type	Description
operations	array	<p>Correlation operations to create for the correlation.</p> <p>Parameter behavior:</p> <p>- <i>required</i></p>

Parameter	Type	Description
filter	object	Correlation filter object for the correlation.

Parameter behavior:
- *required*

Return values

(object) Returns an object containing the IDs of the created correlations under the `correlationids` property. The order of the returned IDs matches the order of the passed correlations.

Examples

Create a new event tag correlation

Create a correlation using evaluation method AND/OR with one condition and one operation. By default the correlation will be enabled.

Request:

```
{
  "jsonrpc": "2.0",
  "method": "correlation.create",
  "params": {
    "name": "new event tag correlation",
    "filter": {
      "evaltype": 0,
      "conditions": [
        {
          "type": 1,
          "tag": "ok"
        }
      ]
    },
    "operations": [
      {
        "type": 0
      }
    ]
  },
  "id": 1
}
```

Response:

```
{
  "jsonrpc": "2.0",
  "result": {
    "correlationids": [
      "1"
    ]
  },
  "id": 1
}
```

Using a custom expression filter

Create a correlation that will use a custom filter condition. The formula IDs "A" or "B" have been chosen arbitrarily. Condition type will be "Host group" with operator "<>".

Request:

```
{
  "jsonrpc": "2.0",
  "method": "correlation.create",
  "params": {
    "name": "new host group correlation",
```

```

    "description": "a custom description",
    "status": 0,
    "filter": {
        "evaltype": 3,
        "formula": "A or B",
        "conditions": [
            {
                "type": 2,
                "operator": 1,
                "formulaid": "A"
            },
            {
                "type": 2,
                "operator": 1,
                "formulaid": "B"
            }
        ]
    },
    "operations": [
        {
            "type": 1
        }
    ]
},
    "id": 1
}

```

Response:

```

{
    "jsonrpc": "2.0",
    "result": {
        "correlationids": [
            "2"
        ]
    },
    "id": 1
}

```

See also

- [Correlation filter](#)
- [Correlation operation](#)

Source

CCorrelation::create() in *ui/include/classes/api/services/CCorrelation.php*.

correlation.delete

Description

object correlation.delete(array correlationids)

This method allows to delete correlations.

Note:

This method is only available to *Super admin* user type. Permissions to call the method can be revoked in user role settings. See [User roles](#) for more information.

Parameters

(array) IDs of the correlations to delete.

Return values

(object) Returns an object containing the IDs of the deleted correlations under the `correlationids` property.

Example

Delete multiple correlations

Delete two correlations.

Request:

```
{
  "jsonrpc": "2.0",
  "method": "correlation.delete",
  "params": [
    "1",
    "2"
  ],
  "id": 1
}
```

Response:

```
{
  "jsonrpc": "2.0",
  "result": {
    "correlationids": [
      "1",
      "2"
    ]
  },
  "id": 1
}
```

Source

CCorrelation::delete() in *ui/include/classes/api/services/CCorrelation.php*.

correlation.get

Description

integer/array correlation.get(object parameters)

The method allows to retrieve correlations according to the given parameters.

Note:

This method is available to users of any type. Permissions to call the method can be revoked in user role settings. See [User roles](#) for more information.

Parameters

(object) Parameters defining the desired output.

The method supports the following parameters.

Parameter	Type	Description
correlationids	ID/array	Return only correlations with the given IDs.
selectFilter	query	Return a filter property with the correlation conditions.
selectOperations	query	Return an operations property with the correlation operations.
sortfield	string/array	Sort the result by the given properties.
countOutput	boolean	Possible values: <code>correlationid</code> , <code>name</code> , <code>status</code> . These parameters being common for all get methods are described in the reference commentary .
editable	boolean	
excludeSearch	boolean	
filter	object	
limit	integer	
output	query	

Parameter	Type	Description
preservekeys	boolean	
search	object	
searchByAny	boolean	
searchWildcardsEnabled	boolean	
sortorder	string/array	
startSearch	boolean	

Return values

(integer/array) Returns either:

- an array of objects;
- the count of retrieved objects, if the `countOutput` parameter has been used.

Examples

Retrieve correlations

Retrieve all configured correlations together with correlation conditions and operations. The filter uses the "and/or" evaluation type, so the `formula` property is empty and `eval_formula` is generated automatically.

Request:

```
{
  "jsonrpc": "2.0",
  "method": "correlation.get",
  "params": {
    "output": "extend",
    "selectOperations": "extend",
    "selectFilter": "extend"
  },
  "id": 1
}
```

Response:

```
{
  "jsonrpc": "2.0",
  "result": [
    {
      "correlationid": "1",
      "name": "Correlation 1",
      "description": "",
      "status": "0",
      "filter": {
        "evaltype": "0",
        "formula": "",
        "conditions": [
          {
            "type": "3",
            "oldtag": "error",
            "newtag": "ok",
            "formulaid": "A"
          }
        ],
        "eval_formula": "A"
      },
      "operations": [
        {
          "type": "0"
        }
      ]
    }
  ],
}
```

```
"id": 1
}
```

See also

- [Correlation filter](#)
- [Correlation operation](#)

Source

CCorrelation::get() in *ui/include/classes/api/services/CCorrelation.php*.

correlation.update

Description

object correlation.update(object/array correlations)

This method allows to update existing correlations.

Note:

This method is only available to *Super admin* user type. Permissions to call the method can be revoked in user role settings. See [User roles](#) for more information.

Parameters

(object/array) Correlation properties to be updated.

The `correlationid` property must be defined for each correlation, all other properties are optional. Only the passed properties will be updated, all others will remain unchanged.

Additionally to the [standard correlation properties](#), the method accepts the following parameters.

Parameter	Type	Description
filter	object	Correlation filter object to replace the current filter.
operations	array	Correlation operations to replace existing operations.

Return values

(object) Returns an object containing the IDs of the updated correlations under the `correlationids` property.

Examples

Disable correlation

Request:

```
{
  "jsonrpc": "2.0",
  "method": "correlation.update",
  "params": {
    "correlationid": "1",
    "status": "1"
  },
  "id": 1
}
```

Response:

```
{
  "jsonrpc": "2.0",
  "result": {
    "correlationids": [
      "1"
    ]
  },
  "id": 1
}
```

Replace conditions, but keep the evaluation method

Request:

```
{
  "jsonrpc": "2.0",
  "method": "correlation.update",
  "params": {
    "correlationid": "1",
    "filter": {
      "conditions": [
        {
          "type": 3,
          "oldtag": "error",
          "newtag": "ok"
        }
      ]
    }
  },
  "id": 1
}
```

Response:

```
{
  "jsonrpc": "2.0",
  "result": {
    "correlationids": [
      "1"
    ]
  },
  "id": 1
}
```

See also

- [Correlation filter](#)
- [Correlation operation](#)

Source

`CCorrelation::update()` in `ui/include/classes/api/services/CCorrelation.php`.

Dashboard

This class is designed to work with dashboards.

Object references:

- [Dashboard](#)
- [Dashboard page](#)
- [Dashboard widget](#)
- [Dashboard widget field](#)
- [Dashboard user group](#)
- [Dashboard user](#)

Available methods:

- `dashboard.create` - create new dashboards
- `dashboard.delete` - delete dashboards
- `dashboard.get` - retrieve dashboards
- `dashboard.update` - update dashboards

Dashboard object

The following objects are directly related to the dashboard API.

Dashboard

The dashboard object has the following properties.

Property	Type	Description
dashboardid	ID	ID of the dashboard.
name	string	<p>Property behavior:</p> <ul style="list-style-type: none">- <i>read-only</i>- <i>required</i> for update operations Name of the dashboard.
userid	ID	ID of the user that is the owner of the dashboard.
private	integer	Type of dashboard sharing.
display_period	integer	<p>Possible values:</p> <ul style="list-style-type: none">0 - public dashboard;1 - (<i>default</i>) private dashboard. Default page display period (in seconds).
auto_start	integer	<p>Possible values:</p> <ul style="list-style-type: none">0 - do not auto start slideshow;1 - (<i>default</i>) auto start slideshow. Default: 30. Auto start slideshow.

Dashboard page

The dashboard page object has the following properties.

Property	Type	Description
dashboard_pageid	ID	ID of the dashboard page.
name	string	<p>Property behavior:</p> <ul style="list-style-type: none">- <i>read-only</i> Dashboard page name.
display_period	integer	<p>Default: empty string.</p> Dashboard page display period (in seconds).
widgets	array	<p>Possible values: 0, 10, 30, 60, 120, 600, 1800, 3600.</p> <p>Default: 0 (will use the default page display period).</p> Array of the dashboard widget objects.

Dashboard widget

The dashboard widget object has the following properties.

Property	Type	Description
widgetid	ID	ID of the dashboard widget.
		<p>Property behavior:</p> <ul style="list-style-type: none">- <i>read-only</i>

Property	Type	Description
type	string	Type of the dashboard widget. Possible values: actionlog - Action log; clock - Clock; discovery - Discovery status; favgraphs - Favorite graphs; favmaps - Favorite maps; gauge - Gauge; geomap - Geomap; graph - Graph (classic); graphprototype - Graph prototype; honeycomb - Honeycomb; hostavail - Host availability; hostcard - Host card; hostnavigator - Host navigator; itemhistory - Item history; itemnavigator - Item navigator; item - Item value; map - Map; navtree - Map Navigation Tree; piechart - Pie chart; problemhosts - Problem hosts; problems - Problems; problemsbysv - Problems by severity; slareport - SLA report; svggraph - Graph; systeminfo - System information; tophosts - Top hosts; topitems - Top items; toptriggers - Top triggers; trigover - Trigger overview; url - URL; web - Web monitoring. Property behavior: - <i>required</i>
name	string	Custom widget name.
x	integer	A horizontal position from the left side of the dashboard.
y	integer	Possible values range from 0 to 71. A vertical position from the top of the dashboard.
width	integer	Possible values range from 0 to 63. The widget width.
height	integer	Possible values range from 1 to 72. The widget height.
view_mode	integer	Possible values range from 1 to 64. The widget view mode.
fields	array	Possible values: 0 - (<i>default</i>) default widget view; 1 - with hidden header; Array of the dashboard widget field objects. Property behavior: - see individual widgets in Dashboard widget fields

The dashboard widget field object has the following properties.

Property	Type	Description
type	integer	Type of the widget field. Possible values: 0 - Integer; 1 - String; 2 - Host group; 3 - Host; 4 - Item; 5 - Item prototype; 6 - Graph; 7 - Graph prototype; 8 - Map; 9 - Service; 10 - SLA; 11 - User; 12 - Action; 13 - Media type.
name	string	Property behavior: - <i>required</i> Widget field name. Possible values: see Dashboard widget fields .
value	mixed	Property behavior: - <i>required</i> Widget field value depending on the type. Possible values: see Dashboard widget fields . Property behavior: - <i>required</i>

Dashboard user group

List of dashboard permissions based on user groups. It has the following properties.

Property	Type	Description
usrgrpid	ID	ID of the user group.
permission	integer	Property behavior: - <i>required</i> Type of permission level. Possible values: 2 - read only; 3 - read-write. Property behavior: - <i>required</i>

Dashboard user

List of dashboard permissions based on users. It has the following properties.

Property	Type	Description
userid	ID	ID of the user.
permission	integer	<p>Type of permission level.</p> <p>Possible values: 2 - read only; 3 - read-write.</p> <p>Property behavior: - <i>required</i></p>

dashboard.create

Description

object dashboard.create(object/array dashboards)

This method allows to create new dashboards.

Note:

This method is available to users of any type. Permissions to call the method can be revoked in user role settings. See [User roles](#) for more information.

Parameters

(object/array) Dashboards to create.

Additionally to the [standard dashboard properties](#), the method accepts the following parameters.

Parameter	Type	Description
pages	array	<p>Dashboard pages to be created for the dashboard. Dashboard pages will be ordered in the same order as specified.</p> <p>Parameter behavior: - <i>required</i></p>
users	array	Dashboard user shares to be created on the dashboard.
userGroups	array	Dashboard user group shares to be created on the dashboard.

Return values

(object) Returns an object containing the IDs of the created dashboards under the dashboardids property. The order of the returned IDs matches the order of the passed dashboards.

Examples

Creating a dashboard

Create a dashboard named "My dashboard" with one Problems widget with tags and using two types of sharing (user group and user) on a single dashboard page.

Request:

```
{
  "jsonrpc": "2.0",
  "method": "dashboard.create",
  "params": {
    "name": "My dashboard",
    "display_period": 30,
    "auto_start": 1,
    "pages": [
      {
```

```

        "widgets": [
            {
                "type": "problems",
                "x": 0,
                "y": 0,
                "width": 36,
                "height": 5,
                "view_mode": 0,
                "fields": [
                    {
                        "type": 1,
                        "name": "tags.0.tag",
                        "value": "service"
                    },
                    {
                        "type": 0,
                        "name": "tags.0.operator",
                        "value": 1
                    },
                    {
                        "type": 1,
                        "name": "tags.0.value",
                        "value": "zabbix_server"
                    }
                ]
            }
        ],
        "userGroups": [
            {
                "usrgrpid": "7",
                "permission": 2
            }
        ],
        "users": [
            {
                "userid": "4",
                "permission": 3
            }
        ]
    },
    "id": 1
}

```

Response:

```

{
    "jsonrpc": "2.0",
    "result": {
        "dashboardids": [
            "2"
        ]
    },
    "id": 1
}

```

See also

- [Dashboard page](#)
- [Dashboard widget](#)
- [Dashboard widget field](#)
- [Dashboard user](#)
- [Dashboard user group](#)

Source

CDashboard::create() in *ui/include/classes/api/services/CDashboard.php*.

dashboard.delete

Description

object dashboard.delete(array dashboardids)

This method allows to delete dashboards.

Note:

This method is available to users of any type. Permissions to call the method can be revoked in user role settings. See [User roles](#) for more information.

Parameters

(array) IDs of the dashboards to delete.

Return values

(object) Returns an object containing the IDs of the deleted dashboards under the `dashboardids` property.

Examples

Deleting multiple dashboards

Delete two dashboards.

Request:

```
{
  "jsonrpc": "2.0",
  "method": "dashboard.delete",
  "params": [
    "2",
    "3"
  ],
  "id": 1
}
```

Response:

```
{
  "jsonrpc": "2.0",
  "result": {
    "dashboardids": [
      "2",
      "3"
    ]
  },
  "id": 1
}
```

Source

CDashboard::delete() in *ui/include/classes/api/services/CDashboard.php*.

dashboard.get

Description

integer/array dashboard.get(object parameters)

The method allows to retrieve dashboards according to the given parameters.

Note:

This method is available to users of any type. Permissions to call the method can be revoked in user role settings. See [User roles](#) for more information.

Parameters

(object) Parameters defining the desired output.

The method supports the following parameters.

Parameter	Type	Description
dashboardids	ID/array	Return only dashboards with the given IDs.
selectPages	query	Return a <code>pages</code> property with dashboard pages, correctly ordered.
selectUsers	query	Return a <code>users</code> property with users that the dashboard is shared with.
selectUserGroups	query	Return a <code>userGroups</code> property with user groups that the dashboard is shared with.
sortfield	string/array	Sort the result by the given properties. Possible values: <code>dashboardid</code> .
countOutput	boolean	These parameters being common for all get methods are described in detail in the reference commentary page.
editable	boolean	
excludeSearch	boolean	
filter	object	
limit	integer	
output	query	
preservekeys	boolean	
search	object	
searchByAny	boolean	
searchWildcardsEnabled	boolean	
sortorder	string/array	
startSearch	boolean	

Return values

(integer/array) Returns either:

- an array of objects;
- the count of retrieved objects, if the `countOutput` parameter has been used.

Examples**Retrieving a dashboard by ID**

Retrieve all data about dashboards "1" and "2".

Request:

```
{
  "jsonrpc": "2.0",
  "method": "dashboard.get",
  "params": {
    "output": "extend",
    "selectPages": "extend",
    "selectUsers": "extend",
    "selectUserGroups": "extend",
    "dashboardids": [
      "1",
      "2"
    ]
  },
  "id": 1
}
```

Response:

```

{
  "jsonrpc": "2.0",
  "result": [
    {
      "dashboardid": "1",
      "name": "Dashboard",
      "userid": "1",
      "private": "0",
      "display_period": "30",
      "auto_start": "1",
      "users": [],
      "userGroups": [],
      "pages": [
        {
          "dashboard_pageid": "1",
          "name": "",
          "display_period": "0",
          "widgets": [
            {
              "widgetid": "9",
              "type": "systeminfo",
              "name": "",
              "x": "12",
              "y": "8",
              "width": "12",
              "height": "5",
              "view_mode": "0",
              "fields": []
            },
            {
              "widgetid": "8",
              "type": "problemsbysv",
              "name": "",
              "x": "12",
              "y": "4",
              "width": "12",
              "height": "4",
              "view_mode": "0",
              "fields": []
            },
            {
              "widgetid": "7",
              "type": "problemhosts",
              "name": "",
              "x": "12",
              "y": "0",
              "width": "12",
              "height": "4",
              "view_mode": "0",
              "fields": []
            },
            {
              "widgetid": "6",
              "type": "discovery",
              "name": "",
              "x": "6",
              "y": "9",
              "width": "18",
              "height": "4",
              "view_mode": "0",
              "fields": []
            }
          ]
        }
      ]
    }
  ]
}

```



```

    {
      "widgetid": "5",
      "type": "web",
      "name": "",
      "x": "0",
      "y": "9",
      "width": "18",
      "height": "4",
      "view_mode": "0",
      "fields": []
    },
    {
      "widgetid": "4",
      "type": "problems",
      "name": "",
      "x": "0",
      "y": "3",
      "width": "12",
      "height": "6",
      "view_mode": "0",
      "fields": []
    },
    {
      "widgetid": "3",
      "type": "favmaps",
      "name": "",
      "x": "8",
      "y": "0",
      "width": "12",
      "height": "3",
      "view_mode": "0",
      "fields": []
    },
    {
      "widgetid": "1",
      "type": "favgraphs",
      "name": "",
      "x": "0",
      "y": "0",
      "width": "12",
      "height": "3",
      "view_mode": "0",
      "fields": []
    }
  ]
},
{
  "dashboard_pageid": "2",
  "name": "",
  "display_period": "0",
  "widgets": []
},
{
  "dashboard_pageid": "3",
  "name": "Custom page name",
  "display_period": "60",
  "widgets": []
}
],
{
  "dashboardid": "2",

```

```

    "name": "My dashboard",
    "userid": "1",
    "private": "1",
    "display_period": "60",
    "auto_start": "1",
    "users": [
      {
        "userid": "4",
        "permission": "3"
      }
    ],
    "userGroups": [
      {
        "usrgrpid": "7",
        "permission": "2"
      }
    ],
    "pages": [
      {
        "dashboard_pageid": "4",
        "name": "",
        "display_period": "0",
        "widgets": [
          {
            "widgetid": "10",
            "type": "problems",
            "name": "",
            "x": "0",
            "y": "0",
            "width": "12",
            "height": "5",
            "view_mode": "0",
            "fields": [
              {
                "type": "2",
                "name": "groupids",
                "value": "4"
              }
            ]
          }
        ]
      }
    ]
  },
  "id": 1
}

```

See also

- [Dashboard page](#)
- [Dashboard widget](#)
- [Dashboard widget field](#)
- [Dashboard user](#)
- [Dashboard user group](#)

Source

CDashboard::get() in *ui/include/classes/api/services/CDashboard.php*.

dashboard.update

Description

object dashboard.update(object/array dashboards)

This method allows to update existing dashboards.

Note:

This method is available to users of any type. Permissions to call the method can be revoked in user role settings. See [User roles](#) for more information.

Parameters

(object/array) Dashboard properties to be updated.

The dashboardid property must be defined for each dashboard, all other properties are optional. Only the passed properties will be updated, all others will remain unchanged.

Additionally to the [standard dashboard properties](#), the method accepts the following parameters.

Parameter	Type	Description
pages	array	Dashboard pages to replace the existing dashboard pages. Dashboard pages are updated by the dashboard_pageid property. New dashboard pages will be created for objects without dashboard_pageid property and the existing dashboard pages will be deleted if not reused. Dashboard pages will be ordered in the same order as specified. Only the specified properties of the dashboard pages will be updated.
users	array	Dashboard user shares to replace the existing elements.
userGroups	array	Dashboard user group shares to replace the existing elements.

Return values

(object) Returns an object containing the IDs of the updated dashboards under the dashboardids property.

Examples

Renaming a dashboard

Rename a dashboard to "SQL server status".

Request:

```
{
  "jsonrpc": "2.0",
  "method": "dashboard.update",
  "params": {
    "dashboardid": "2",
    "name": "SQL server status"
  },
  "id": 1
}
```

Response:

```
{
  "jsonrpc": "2.0",
  "result": {
    "dashboardids": [
      "2"
    ]
  },
  "id": 1
}
```

Updating dashboard pages

Rename the first dashboard page, replace widgets on the second dashboard page and add a new page as the third one. Delete all other dashboard pages.

Request:

```

{
  "jsonrpc": "2.0",
  "method": "dashboard.update",
  "params": {
    "dashboardid": "2",
    "pages": [
      {
        "dashboard_pageid": 1,
        "name": "Renamed Page"
      },
      {
        "dashboard_pageid": 2,
        "widgets": [
          {
            "type": "clock",
            "x": 0,
            "y": 0,
            "width": 12,
            "height": 3
          }
        ]
      }
    ],
    {
      "display_period": 60
    }
  ]
},
"id": 1
}

```

Response:

```

{
  "jsonrpc": "2.0",
  "result": {
    "dashboardids": [
      "2"
    ]
  },
  "id": 1
}

```

Change dashboard owner

Available only for admins and super admins.

Request:

```

{
  "jsonrpc": "2.0",
  "method": "dashboard.update",
  "params": {
    "dashboardid": "2",
    "userid": "1"
  },
  "id": 1
}

```

Response:

```

{
  "jsonrpc": "2.0",
  "result": {
    "dashboardids": [
      "2"
    ]
  }
}

```

```
},  
  "id": 1  
}
```

See also

- [Dashboard page](#)
- [Dashboard widget](#)
- [Dashboard widget field](#)
- [Dashboard user](#)
- [Dashboard user group](#)

Source

`CDashboard::update()` in `ui/include/classes/api/services/CDashboard.php`.

Dashboard widget fields

This page contains navigation links for dashboard widget parameters and possible property values for the respective **dashboard widget field** objects.

To see the parameters and property values for each widget, go to individual widget pages for:

- [Action log](#)
- [Clock](#)
- [Discovery status](#)
- [Favorite graphs](#)
- [Favorite maps](#)
- [Gauge](#)
- [Geomap](#)
- [Graph](#)
- [Graph \(classic\)](#)
- [Graph prototype](#)
- [Honeycomb](#)
- [Host availability](#)
- [Host card](#)
- [Host navigator](#)
- [Item history](#)
- [Item navigator](#)
- [Item value](#)
- [Map](#)
- [Map navigation tree](#)
- [Pie chart](#)
- [Problem hosts](#)
- [Problems](#)
- [SLA report](#)
- [System information](#)
- [Problems by severity](#)
- [Top hosts](#)
- [Top items](#)
- [Top triggers](#)
- [Trigger overview](#)
- [URL](#)
- [Web monitoring](#)

Attention:

Deprecated widgets will be removed in the upcoming major release.

1 [Action log](#)

Description

These parameters and the possible property values for the respective dashboard widget field objects allow to configure the *Action log* widget in `dashboard.create` and `dashboard.update` methods.

Attention:

Widget fields properties are not validated during the creation or update of a dashboard. This allows users to modify **built-in widgets** and create **custom widgets**, but also introduces the risk of creating or updating widgets incorrectly. To ensure the successful creation or update of the *Action log* widget, please refer to the parameter behavior outlined in the tables below.

Parameters

The following parameters are supported for the *Action log* widget.

Parameter	type	name	value
<i>Refresh interval</i>	0	rf_rate	0 - No refresh; 10 - 10 seconds; 30 - 30 seconds; 60 - (default) 1 minute; 120 - 2 minutes; 600 - 10 minutes; 900 - 15 minutes.
<i>Recipients</i>	11	userids.0	User ID. Note: To configure multiple users, create a dashboard widget field object for each user with an incremented number in the property name.
<i>Actions</i>	12	actionids.0	Action ID. Note: To configure multiple actions, create a dashboard widget field object for each action with an incremented number in the property name.
<i>Media types</i>	13	mediatypeids.0	Media type ID. Note: To configure multiple media types, create a dashboard widget field object for each media type with an incremented number in the property name.
<i>Status</i>	0	statuses.0	0 - In progress; 1 - Sent/Executed; 2 - Failed. Note: To configure multiple values, create a dashboard widget field object for each value with an incremented number in the property name.
<i>Search string</i>	1	message	Any string value.
<i>Time period</i>	1	time_period.reference	DASHBOARD._timeperiod - set the Time period selector as the data source; ABCDE._timeperiod - set a compatible widget (with its <i>Reference</i> parameter set to "ABCDE") as the data source. Default: DASHBOARD._timeperiod Alternatively, you can set the time period only in the <i>From</i> and <i>To</i> parameters.
<i>From</i>	1	time_period.from	Valid time string in absolute (YYYY-MM-DD hh:mm:ss) or relative time syntax (now, now/d, now/w-1w, etc.). Parameter behavior: - supported if <i>Time period</i> is not set

Parameter	type	name	value
<i>To</i>	1	time_period.to	Valid time string in absolute (YYYY-MM-DD hh:mm:ss) or relative time syntax (now, now/d, now/w-1w, etc.). Parameter behavior: - <i>supported</i> if Time period is not set
<i>Sort entries by</i>	0	sort_triggers	3 - Time (ascending); 4 - (<i>default</i>) Time (descending); 5 - Type (ascending); 6 - Type (descending); 7 - Status (ascending); 8 - Status (descending); 11 - Recipient (ascending); 12 - Recipient (descending).
<i>Show lines</i>	0	show_lines	Possible values range from 1-100. Default: 25.

Examples

The following examples aim to only describe the configuration of the dashboard widget field objects for the *Action log* widget. For more information on configuring a dashboard, see [dashboard.create](#).

Configuring an *Action log* widget

Configure an *Action log* widget that displays 10 entries of action operation details, sorted by time (in ascending order). In addition, display details only for those action operations that attempted to send an email to user "1", but were unsuccessful.

Request:

```
{
  "jsonrpc": "2.0",
  "method": "dashboard.create",
  "params": {
    "name": "My dashboard",
    "display_period": 30,
    "auto_start": 1,
    "pages": [
      {
        "widgets": [
          {
            "type": "actionlog",
            "name": "Action log",
            "x": 0,
            "y": 0,
            "width": 36,
            "height": 5,
            "view_mode": 0,
            "fields": [
              {
                "type": 0,
                "name": "show_lines",
                "value": 10
              },
              {
                "type": 0,
                "name": "sort_triggers",
                "value": 3
              },
              {
                "type": 11,
                "name": "userids.0",
                "value": 1
              }
            ]
          }
        ]
      }
    ]
  }
}
```

```

    {
      "type": 13,
      "name": "mediatypeids.0",
      "value": 1
    },
    {
      "type": 0,
      "name": "statuses.0",
      "value": 2
    }
  ]
},
"userGroups": [
  {
    "usrgrpId": 7,
    "permission": 2
  }
],
"users": [
  {
    "userId": 1,
    "permission": 3
  }
]
},
"id": 1
}

```

Response:

```

{
  "jsonrpc": "2.0",
  "result": {
    "dashboardids": [
      "3"
    ]
  },
  "id": 1
}

```

See also

- [Dashboard widget field](#)
- [dashboard.create](#)
- [dashboard.update](#)

2 Clock

Description

These parameters and the possible property values for the respective dashboard widget field objects allow to configure the *Clock* widget in `dashboard.create` and `dashboard.update` methods.

Attention:

Widget fields properties are not validated during the creation or update of a dashboard. This allows users to modify **built-in widgets** and create **custom widgets**, but also introduces the risk of creating or updating widgets incorrectly. To ensure the successful creation or update of the *Clock* widget, please refer to the parameter behavior outlined in the tables below.

Parameters

The following parameters are supported for the *Clock* widget.

Parameter	type	name	value
<i>Refresh interval</i>	0	rf_rate	0 - No refresh; 10 - 10 seconds; 30 - 30 seconds; 60 - 1 minute; 120 - 2 minutes; 600 - 10 minutes; 900 - (default) 15 minutes.
<i>Time type</i>	0	time_type	0 - (default) Local time; 1 - Server time; 2 - Host time.
<i>Clock type</i>	0	clock_type	0 - (default) Analog; 1 - Digital.

The following parameters are supported if *Time type* is set to "Host time".

Parameter	type	name	value
<i>Item</i>	4	itemid.0	Item ID. Parameter behavior: - required

The following parameters are supported if *Clock type* is set to "Digital".

Parameter	type	name	value
<i>Show</i>	0	show.0	1 - Date; 2 - (default) Time; 3 - Time zone.

Note: To configure multiple values, create a dashboard widget field object for each value with an incremented number in the property name.

Advanced configuration

The following advanced configuration parameters are supported if *Clock type* is set to "Digital".

Parameter	type	name	value
<i>Background color</i>	1	bg_color	Hexadecimal color code (e.g. FF0000). Default: "" (empty).

Date

The following advanced configuration parameters are supported if *Clock type* is set to "Digital", and *Show* is set to "Date".

Parameter	type	name	value
<i>Bold</i>	0	date_bold	0 - (default) Disabled; 1 - Enabled.
<i>Color</i>	1	date_color	Hexadecimal color code (e.g. FF0000). Default: "" (empty).

Time

The following advanced configuration parameters are supported if *Clock type* is set to "Digital", and *Show* is set to "Time".

Parameter	type	name	value
<i>Bold</i>	0	time_bold	0 - (default) Disabled; 1 - Enabled.
<i>Color</i>	1	time_color	Hexadecimal color code (e.g. FF0000).
<i>Seconds</i>	0	time_sec	Default: "" (empty). 0 - Disabled; 1 - (default) Enabled.
<i>Format</i>	0	time_format	0 - (default) 24-hour; 1 - 12-hour.

Time zone

The following advanced configuration parameters are supported if *Clock type* is set to "Digital", and *Show* is set to "Time zone".

Parameter	type	name	value
<i>Bold</i>	0	tzone_bold	0 - (default) Disabled; 1 - Enabled.
<i>Color</i>	1	tzone_color	Hexadecimal color code (e.g. FF0000).
<i>Time zone</i>	1	tzone_timezone	Default: "" (empty). Valid timezone string (e.g. Europe/Riga, system, UTC, etc.). For the full list of supported time zones please refer to PHP documentation .
<i>Format</i>	0	tzone_format	Default: local. Parameter behavior: - supported if <i>Time type</i> is set to "Local time" or "Server time" 0 - (default) Short; 1 - Full. Parameter behavior: - supported if <i>Time type</i> is set to "Local time" or "Server time"

Examples

The following examples aim to only describe the configuration of the dashboard widget field objects for the *Clock* widget. For more information on configuring a dashboard, see [dashboard.create](#).

Configuring a *Clock* widget

Configure a *Clock* widget that displays local date, time and time zone in a customized digital clock.

Request:

```
{
  "jsonrpc": "2.0",
  "method": "dashboard.create",
  "params": {
    "name": "My dashboard",
    "display_period": 30,
    "auto_start": 1,
    "pages": [
      {
        "widgets": [
          {
            "type": "clock",
            "name": "Clock",
            "x": 0,
            "y": 0,
            "width": 12,
            "height": 3,
            "view_mode": 0,

```

```

        "fields": [
            {
                "type": 0,
                "name": "clock_type",
                "value": 1
            },
            {
                "type": 0,
                "name": "show.0",
                "value": 1
            },
            {
                "type": 0,
                "name": "show.1",
                "value": 2
            },
            {
                "type": 0,
                "name": "show.2",
                "value": 3
            },
            {
                "type": 1,
                "name": "date_color",
                "value": "E1E1E1"
            },
            {
                "type": 0,
                "name": "time_bold",
                "value": 1
            },
            {
                "type": 1,
                "name": "tzone_color",
                "value": "E1E1E1"
            },
            {
                "type": 1,
                "name": "tzone_timezone",
                "value": "Europe/Riga"
            },
            {
                "type": 0,
                "name": "tzone_format",
                "value": 1
            }
        ]
    },
    ],
    "userGroups": [
        {
            "usrgrpId": 7,
            "permission": 2
        }
    ],
    "users": [
        {
            "userid": 1,
            "permission": 3
        }
    ]
}

```

```

    ],
  },
  "id": 1
}

```

Response:

```

{
  "jsonrpc": "2.0",
  "result": {
    "dashboardids": [
      "3"
    ]
  },
  "id": 1
}

```

See also

- [Dashboard widget field](#)
- [dashboard.create](#)
- [dashboard.update](#)

3 Discovery status

Description

These parameters and the possible property values for the respective dashboard widget field objects allow to configure the *Discovery status* widget in `dashboard.create` and `dashboard.update` methods.

Parameters

The following parameters are supported for the *Discovery status* widget.

Parameter	type	name	value
<i>Refresh interval</i>	0	rf_rate	0 - No refresh; 10 - 10 seconds; 30 - 30 seconds; 60 - (default) 1 minute; 120 - 2 minutes; 600 - 10 minutes; 900 - 15 minutes.

Examples

The following examples aim to only describe the configuration of the dashboard widget field objects for the *Discovery status* widget. For more information on configuring a dashboard, see [dashboard.create](#).

Configuring *Discovery status* widget

Configure a *Discovery status* widget with the refresh interval set to 15 minutes.

Request:

```

{
  "jsonrpc": "2.0",
  "method": "dashboard.create",
  "params": {
    "name": "My dashboard",
    "display_period": 30,
    "auto_start": 1,
    "pages": [
      {
        "widgets": [

```

```

        "type": "discovery",
        "name": "Discovery status",
        "x": 0,
        "y": 0,
        "width": 18,
        "height": 3,
        "view_mode": 0,
        "fields": [
            {
                "type": 0,
                "name": "rf_rate",
                "value": 900
            }
        ]
    },
    ],
    "userGroups": [
        {
            "usrgrpid": 7,
            "permission": 2
        }
    ],
    "users": [
        {
            "userid": 1,
            "permission": 3
        }
    ]
},
"id": 1
}

```

Response:

```

{
  "jsonrpc": "2.0",
  "result": {
    "dashboardids": [
      "3"
    ]
  },
  "id": 1
}

```

See also

- [Dashboard widget field](#)
- [dashboard.create](#)
- [dashboard.update](#)

4 Favorite graphs

Description

These parameters and the possible property values for the respective dashboard widget field objects allow to configure the *Favorite graphs* widget in `dashboard.create` and `dashboard.update` methods.

Parameters

The following parameters are supported for the *Favorite graphs* widget.

Parameter	type	name	value
<i>Refresh interval</i>	0	rf_rate	0 - No refresh; 10 - 10 seconds; 30 - 30 seconds; 60 - 1 minute; 120 - 2 minutes; 600 - 10 minutes; 900 - (<i>default</i>) 15 minutes.

Examples

The following examples aim to only describe the configuration of the dashboard widget field objects for the *Favorite graphs* widget. For more information on configuring a dashboard, see [dashboard.create](#).

Configuring a *Favorite graphs* widget

Configure a *Favorite graphs* widget with the refresh interval set to 10 minutes.

Request:

```
{
  "jsonrpc": "2.0",
  "method": "dashboard.create",
  "params": {
    "name": "My dashboard",
    "display_period": 30,
    "auto_start": 1,
    "pages": [
      {
        "widgets": [
          {
            "type": "favgraphs",
            "name": "Favorite graphs",
            "x": 0,
            "y": 0,
            "width": 12,
            "height": 3,
            "view_mode": 0,
            "fields": [
              {
                "type": 0,
                "name": "rf_rate",
                "value": 600
              }
            ]
          }
        ]
      }
    ]
  },
  "userGroups": [
    {
      "usrgrpId": 7,
      "permission": 2
    }
  ],
  "users": [
    {
      "userid": 1,
      "permission": 3
    }
  ]
},
{id": 1
}
```

Response:

```
{
  "jsonrpc": "2.0",
  "result": {
    "dashboardids": [
      "3"
    ]
  },
  "id": 1
}
```

See also

- [Dashboard widget field](#)
- [dashboard.create](#)
- [dashboard.update](#)

5 Favorite maps

Description

These parameters and the possible property values for the respective dashboard widget field objects allow to configure the *Favorite maps* widget in `dashboard.create` and `dashboard.update` methods.

Parameters

The following parameters are supported for the *Favorite maps* widget.

Parameter	type	name	value
<i>Refresh interval</i>	0	rf_rate	0 - No refresh; 10 - 10 seconds; 30 - 30 seconds; 60 - 1 minute; 120 - 2 minutes; 600 - 10 minutes; 900 - (<i>default</i>) 15 minutes.

Examples

The following examples aim to only describe the configuration of the dashboard widget field objects for the *Favorite maps* widget. For more information on configuring a dashboard, see [dashboard.create](#).

Configuring a *Favorite maps* widget

Configure a *Favorite maps* widget with the refresh interval set to 10 minutes.

Request:

```
{
  "jsonrpc": "2.0",
  "method": "dashboard.create",
  "params": {
    "name": "My dashboard",
    "display_period": 30,
    "auto_start": 1,
    "pages": [
      {
        "widgets": [
          {
            "type": "favmaps",
            "name": "Favorite maps",
            "x": 0,
            "y": 0,
            "width": 12,

```

```

        "height": 3,
        "view_mode": 0,
        "fields": [
            {
                "type": 0,
                "name": "rf_rate",
                "value": 600
            }
        ]
    },
    ],
    "userGroups": [
        {
            "usrgrpid": 7,
            "permission": 2
        }
    ],
    "users": [
        {
            "userid": 1,
            "permission": 3
        }
    ]
},
"id": 1
}

```

Response:

```

{
  "jsonrpc": "2.0",
  "result": {
    "dashboardids": [
      "3"
    ]
  },
  "id": 1
}

```

See also

- [Dashboard widget field](#)
- [dashboard.create](#)
- [dashboard.update](#)

6 Gauge

Description

These parameters and the possible property values for the respective dashboard widget field objects allow to configure the *Gauge* widget in `dashboard.create` and `dashboard.update` methods.

Attention:

Widget fields properties are not validated during the creation or update of a dashboard. This allows users to modify **built-in widgets** and create **custom widgets**, but also introduces the risk of creating or updating widgets incorrectly. To ensure the successful creation or update of the *Gauge* widget, please refer to the parameter behavior outlined in the tables below.

Parameters

The following parameters are supported for the *Gauge* widget.

Parameter	type	name	value
<i>Refresh interval</i>	0	rf_rate	0 - No refresh; 10 - 10 seconds; 30 - 30 seconds; 60 - (default) 1 minute; 120 - 2 minutes; 600 - 10 minutes; 900 - 15 minutes.
<i>Item</i>	4	itemid.0	Item ID.
<i>Item (Widget)</i>	1	itemid._reference	Parameter behavior: - <i>required</i> if <i>Item (Widget)</i> is not set Instead of Item ID: ABCDE._itemid - set a compatible widget (with its <i>Reference</i> parameter set to "ABCDE") as the data source for items.
<i>Min</i>	1	min	Parameter behavior: - <i>required</i> if <i>Item</i> is not set Any numeric value. Suffixes (e.g. "1d", "2w", "4K", "8G") are supported.
<i>Max</i>	1	max	Default: "0". Any numeric value. Suffixes (e.g. "1d", "2w", "4K", "8G") are supported.
<i>Value arc</i>	1	value_arc_color	Default: "100". Hexadecimal color code (e.g. FF0000).
<i>Arc background</i>	1	empty_color	Default: "" (empty). Hexadecimal color code (e.g. FF0000).
<i>Background</i>	1	bg_color	Default: "" (empty). Hexadecimal color code (e.g. FF0000).
<i>Show</i>	0	show.0	Default: "" (empty). 1 - Description; 2 - Value; 3 - Needle; 4 - Scale; 5 - Value arc.
			Note: To configure multiple values, create a dashboard widget field object for each value with an incremented number in the property name.
			Default: 1, 2, 4, 5.
			Values "Needle" and "Scale" are not supported if both: - no dashboard widget field object for <i>Show</i> with the value "Value arc" is set; - <i>Show arc advanced configuration</i> parameter is set to "Disabled".
			Advanced configuration parameters for <i>Show</i> options are not supported if no dashboard widget field objects with the respective values are set.
<i>Override host</i>	1	override_hostid._reference	ABCDE._hostid - set a compatible widget (with its <i>Reference</i> parameter set to "ABCDE") as the data source for hosts; DASHBOARD._hostid - set the dashboard Host selector as the data source for hosts.
			This parameter is not supported if configuring the widget on a template dashboard .

Advanced configuration

The following advanced configuration parameters are supported for the *Gauge* widget.

Note:

The number in the *Thresholds* property name (e.g. `thresholds.0.color`) references the threshold place in a list, sorted in ascending order. However, if thresholds are configured in a different order, the values will be sorted in ascending order after updating widget configuration in Zabbix frontend (e.g. `"thresholds.0.threshold": "5" → "thresholds.0.threshold": "1"; "thresholds.1.threshold": "1" → "thresholds.1.threshold": "5"`).

Parameter	type	name	value
<i>Angle</i>	0	angle	Possible values: 180 (<i>default</i>) or 270.
Description			
<i>Description</i>	1	description	Any string value, including macros. Supported macros: {HOST.*}, {ITEM.*}, {INVENTORY.*}, user macros. Default: {ITEM.NAME}.
<i>Size</i>	0	desc_size	Possible values range from 1-100.
<i>Vertical position</i>	0	desc_v_pos	Default: 15. 0 - Top; 1 - (<i>default</i>) Bottom.
<i>Bold</i>	0	desc_bold	0 - (<i>default</i>) Disabled; 1 - Enabled.
<i>Color</i>	1	desc_color	Hexadecimal color code (e.g. FF0000). Default: "" (empty).
Value			
<i>Decimal places</i>	0	decimal_places	Possible values range from 1-10.
<i>Size</i>	0	value_size	Default: 2. Possible values range from 1-100.
<i>Bold</i>	0	value_bold	Default: 25. 0 - (<i>default</i>) Disabled; 1 - Enabled.
<i>Color</i>	1	value_color	Hexadecimal color code (e.g. FF0000). Default: "" (empty).
Units			
<i>Units (checkbox)</i>	0	units_show	0 - Disabled; 1 - (<i>default</i>) Enabled.
<i>Units (value)</i>	1	units	Any string value.
<i>Size</i>	0	units_size	Parameter behavior: - <i>supported</i> if <i>Units (checkbox)</i> is set to "Enabled" Possible values range from 1-100. Default: 25.
<i>Bold</i>	0	units_bold	Parameter behavior: - <i>supported</i> if <i>Units (checkbox)</i> is set to "Enabled" 0 - (<i>default</i>) Disabled; 1 - Enabled. Parameter behavior: - <i>supported</i> if <i>Units (checkbox)</i> is set to "Enabled"

Parameter	type	name	value
<i>Position</i>	0	units_pos	0 - Before value; 1 - Above value; 2 - (default) After value; 3 - Below value. Parameter behavior: - supported if <i>Units</i> (checkbox) is set to "Enabled" This parameter is ignored if set to one of the following time-related units : unixtime, uptime, s.
<i>Color</i>	1	units_color	Hexadecimal color code (e.g. FF0000). Default: "" (empty).
Value arc <i>Arc size</i>	0	value_arc_size	Possible values range from 1-100. Default: 20.
Needle <i>Color</i>	1	needle_color	Hexadecimal color code (e.g. FF0000). Default: "" (empty). Parameter behavior: - supported if a dashboard widget field object for <i>Show</i> with the value "Value arc" is set, or <i>Show arc</i> is set to "Enabled"
Scale <i>Show units</i>	0	scale_show_units	0 - Disabled; 1 - (default) Enabled. Parameter behavior: - supported if <i>Units</i> (checkbox) is set to "Enabled" and either a dashboard widget field object for <i>Show</i> with the value "Value arc" is set, or <i>Show arc</i> is set to "Enabled"
<i>Size</i>	0	scale_size	Possible values range from 1-100. Default: 15. Parameter behavior: - supported if a dashboard widget field object for <i>Show</i> with the value "Value arc" is set, or <i>Show arc</i> is set to "Enabled"
<i>Decimal places</i>	0	scale_decimal_places	Possible values range from 1-10. Default: 0. Parameter behavior: - supported if a dashboard widget field object for <i>Show</i> with the value "Value arc" is set, or <i>Show arc</i> is set to "Enabled"
Thresholds <i>Color</i>	1	thresholds.0.color	Hexadecimal color code (e.g. FF0000).
<i>Threshold</i>	1	thresholds.0.threshold	Any numeric value. Suffixes (e.g. "1d", "2w", "4K", "8G") are supported.
<i>Show labels</i>	0	th_show_labels	0 - (default) Disabled; 1 - Enabled. Parameter behavior: - supported if <i>Thresholds</i> are set and either a dashboard widget field object for <i>Show</i> with the value "Value arc" is set or <i>Show arc</i> is set to "Enabled"
<i>Show arc</i>	0	th_show_arc	0 - (default) Disabled; 1 - Enabled. Parameter behavior: - supported if <i>Thresholds</i> are set

Parameter	type	name	value
Arc size	0	th_arc_size	Possible values range from 1-100. Default: 5. Parameter behavior: - supported if Show arc is set to "Enabled"

Examples

The following examples aim to only describe the configuration of the dashboard widget field objects for the *Gauge* widget. For more information on configuring a dashboard, see [dashboard.create](#).

Configuring a *Gauge* widget

Configure a *Gauge* widget that displays the item value for the item "44474" (Interface enp0s3: Bits sent). In addition, visually fine-tune the widget with multiple advanced options, including thresholds.

Request:

```
{
  "jsonrpc": "2.0",
  "method": "dashboard.create",
  "params": {
    "name": "My dashboard",
    "display_period": 30,
    "auto_start": 1,
    "pages": [
      {
        "widgets": [
          {
            "type": "gauge",
            "name": "Gauge",
            "x": 0,
            "y": 0,
            "width": 18,
            "height": 5,
            "view_mode": 0,
            "fields": [
              {
                "type": 4,
                "name": "itemid.0",
                "value": 44474
              },
              {
                "type": 1,
                "name": "min",
                "value": "100000"
              },
              {
                "type": 1,
                "name": "max",
                "value": "1000000"
              },
              {
                "type": 0,
                "name": "show.0",
                "value": 1
              },
              {
                "type": 0,
                "name": "show.1",
                "value": 2
              }
            ]
          }
        ]
      }
    ]
  }
}
```

```

{
  "type": 0,
  "name": "show.2",
  "value": 3
},
{
  "type": 0,
  "name": "show.4",
  "value": 4
},
{
  "type": 0,
  "name": "show.5",
  "value": 5
},
{
  "type": 0,
  "name": "angle",
  "value": 270
},
{
  "type": 0,
  "name": "desc_size",
  "value": 10
},
{
  "type": 0,
  "name": "desc_bold",
  "value": 1
},
{
  "type": 0,
  "name": "decimal_places",
  "value": 0
},
{
  "type": 0,
  "name": "value_bold",
  "value": 1
},
{
  "type": 0,
  "name": "units_size",
  "value": 15
},
{
  "type": 0,
  "name": "units_pos",
  "value": 3
},
{
  "type": 1,
  "name": "needle_color",
  "value": "3C3C3C"
},
{
  "type": 1,
  "name": "thresholds.0.color",
  "value": "FF465C"
},
{
  "type": 1,

```

```

        "name": "thresholds.0.threshold",
        "value": "700000"
    },
    {
        "type": 1,
        "name": "thresholds.1.color",
        "value": "FFD54F"
    },
    {
        "type": 1,
        "name": "thresholds.1.threshold",
        "value": "500000"
    },
    {
        "type": 1,
        "name": "thresholds.2.color",
        "value": "0EC9AC"
    },
    {
        "type": 1,
        "name": "thresholds.2.threshold",
        "value": "100000"
    },
    {
        "type": 0,
        "name": "th_show_labels",
        "value": 1
    },
    {
        "type": 0,
        "name": "th_show_arc",
        "value": 1
    },
    {
        "type": 0,
        "name": "th_arc_size",
        "value": 15
    }
}
]
}
],
"userGroups": [
    {
        "usrgrpId": 7,
        "permission": 2
    }
],
"users": [
    {
        "userId": 1,
        "permission": 3
    }
]
},
"id": 1
}

```

Response:

```

{
  "jsonrpc": "2.0",

```

```

"result": {
  "dashboardids": [
    "3"
  ]
},
"id": 1
}

```

See also

- [Dashboard widget field](#)
- [dashboard.create](#)
- [dashboard.update](#)

7 Geomap

Description

These parameters and the possible property values for the respective dashboard widget field objects allow to configure the *Geomap* widget in `dashboard.create` and `dashboard.update` methods.

Attention:

Widget fields properties are not validated during the creation or update of a dashboard. This allows users to modify **built-in widgets** and create **custom widgets**, but also introduces the risk of creating or updating widgets incorrectly. To ensure the successful creation or update of the *Geomap* widget, please refer to the parameter behavior outlined in the tables below.

Parameters

The following parameters are supported for the *Geomap* widget.

Parameter	type	name	value
<i>Refresh interval</i>	0	rf_rate	0 - No refresh; 10 - 10 seconds; 30 - 30 seconds; 60 - <i>(default)</i> 1 minute; 120 - 2 minutes; 600 - 10 minutes; 900 - 15 minutes.
<i>Host groups</i>	2	groupids.0	Host group ID. Note: To configure multiple host groups, create a dashboard widget field object for each host group with an incremented number in the property name. This parameter is not supported if configuring the widget on a template dashboard .
<i>Host groups (Widget)</i>	1	groupids._reference	Instead of Host group ID : ABCDE._hostgroupids - set a compatible widget (with its <i>Reference</i> parameter set to "ABCDE") as the data source for host groups. This parameter is not supported if configuring the widget on a template dashboard .

Parameter	type	name	value
<i>Hosts</i>	3	hostids.0	<p>Host ID.</p> <p>Note: To configure multiple hosts, create a dashboard widget field object for each host with an incremented number in the property name. For multiple hosts, the parameter <i>Host groups</i> must either be not configured at all or configured with at least one host group that the configured hosts belong to.</p> <p>This parameter is not supported if configuring the widget on a template dashboard.</p>
<i>Hosts (Widget/Dashboard)</i>	1	hostids._reference	<p>Instead of Host ID: DASHBOARD.hostids - set the Host selector as the data source for hosts; ABCDE._hostids - set a compatible widget (with its <i>Reference</i> parameter set to "ABCDE") as the data source for hosts.</p> <p>This parameter is not supported if configuring the widget on a template dashboard.</p>
<i>Tags</i>			
<i>Evaluation type</i>	0	evaltype	<p>0 - (default) And/Or; 2 - Or.</p> <p>This parameter is not supported if configuring the widget on a template dashboard.</p>
<i>Tag name</i>	1	tags.0.tag	<p>Any string value.</p> <p>Note: The number in the property name references tag order in the tag evaluation list.</p> <p>Parameter behavior: - <i>required</i> if configuring <i>Tags</i></p>
<i>Operator</i>	0	tags.0.operator	<p>This parameter is not supported if configuring the widget on a template dashboard.</p> <p>0 - Contains; 1 - Equals; 2 - Does not contain; 3 - Does not equal; 4 - Exists; 5 - Does not exist.</p> <p>Note: The number in the property name references tag order in the tag evaluation list.</p> <p>Parameter behavior: - <i>required</i> if configuring <i>Tags</i></p>
<i>Tag value</i>	1	tags.0.value	<p>Any string value.</p> <p>Note: The number in the property name references tag order in the tag evaluation list.</p> <p>Parameter behavior: - <i>required</i> if configuring <i>Tags</i></p>
<i>Initial view</i>	1	default_view	<p>This parameter is not supported if configuring the widget on a template dashboard.</p> <p>Comma separated <i>latitude, longitude, zoom level (optional)</i>, possible values range from 0-30). Example: 40.6892494, -74.0466891, 10.</p>

Parameter	type	name	value
<i>Reference</i>	1	reference	Any string value consisting of 5 characters (e.g., ABCDE or JBPNL). This value must be unique within the dashboard to which the widget belongs.
			Parameter behavior: - <i>required</i>

Examples

The following examples aim to only describe the configuration of the dashboard widget field objects for the *Geomap* widget. For more information on configuring a dashboard, see [dashboard.create](#).

Configuring a *Geomap* widget

Configure a *Geomap* widget that displays hosts from host groups "2" and "22" based on the following tag configuration: tag with the name "component" contains value "node", and tag with the name "location" equals value "New York". In addition, set the map initial view to coordinates "40.6892494" (latitude), "-74.0466891" (longitude) with the zoom level "10".

Request:

```
{
  "jsonrpc": "2.0",
  "method": "dashboard.create",
  "params": {
    "name": "My dashboard",
    "display_period": 30,
    "auto_start": 1,
    "pages": [
      {
        "widgets": [
          {
            "type": "geomap",
            "name": "Geomap",
            "x": 0,
            "y": 0,
            "width": 36,
            "height": 5,
            "view_mode": 0,
            "fields": [
              {
                "type": 2,
                "name": "groupids.0",
                "value": 22
              },
              {
                "type": 2,
                "name": "groupids.1",
                "value": 2
              },
              {
                "type": 1,
                "name": "default_view",
                "value": "40.6892494,-74.0466891,10"
              },
              {
                "type": 0,
                "name": "evaltype",
                "value": 2
              },
              {
                "type": 1,
                "name": "tags.0.tag",
                "value": "component"
              }
            ]
          }
        ]
      }
    ]
  }
}
```

```

    },
    {
      "type": 0,
      "name": "tags.0.operator",
      "value": 0
    },
    {
      "type": 1,
      "name": "tags.0.value",
      "value": "node"
    },
    {
      "type": 1,
      "name": "tags.1.tag",
      "value": "location"
    },
    {
      "type": 0,
      "name": "tags.1.operator",
      "value": 1
    },
    {
      "type": 1,
      "name": "tags.1.value",
      "value": "New York"
    }
  ]
}
  ]
}
],
"userGroups": [
  {
    "usrgrpid": 7,
    "permission": 2
  }
],
"users": [
  {
    "userid": 1,
    "permission": 3
  }
]
},
"id": 1
}

```

Response:

```

{
  "jsonrpc": "2.0",
  "result": {
    "dashboardids": [
      "3"
    ]
  },
  "id": 1
}

```

See also

- [Dashboard widget field](#)
- [dashboard.create](#)
- [dashboard.update](#)

8 Graph

Description

These parameters and the possible property values for the respective dashboard widget field objects allow to configure the *Graph* widget in `dashboard.create` and `dashboard.update` methods.

Attention:

Widget fields properties are not validated during the creation or update of a dashboard. This allows users to modify **built-in widgets** and create **custom widgets**, but also introduces the risk of creating or updating widgets incorrectly. To ensure the successful creation or update of the *Graph* widget, please refer to the parameter behavior outlined in the tables below.

Parameters

The following parameters are supported for the *Graph* widget.

Parameter	type	name	value
<i>Refresh interval</i>	0	rf_rate	0 - No refresh; 10 - 10 seconds; 30 - 30 seconds; 60 - (default) 1 minute; 120 - 2 minutes; 600 - 10 minutes; 900 - 15 minutes.
<i>Reference</i>	1	reference	Any string value consisting of 5 characters (e.g., ABCDE or JBPNL). This value must be unique within the dashboard to which the widget belongs. Parameter behavior: - required

Data set

The following parameters are supported for configuring a *Data set*.

Note:

The first number in the property name (e.g. `ds.0.hosts.0`, `ds.0.items.0`) represents the particular data set, while the second number, if present, represents the configured host or item.

Parameter	type	name	value
<i>Data set type</i>	0	ds.0.dataset_type	0 - Item list; 1 - (default) Item patterns.
<i>Items</i>	4	ds.0.itemids.0	Item ID. When configuring the widget on a template dashboard , only items configured on the template should be set. Note: To configure multiple items, create a dashboard widget field object for each item with an incremented number in the property name. Parameter behavior: - required if <i>Data set type</i> is set to "Item list" and <i>Items (Widget)</i> is not set

Parameter	type	name	value
<i>Items (Widget)</i>	1	ds.0.itemids.0._reference	<p>Instead of Item ID: ABCDE._itemid - set a compatible widget (with its <i>Reference</i> parameter set to "ABCDE") as the data source for items.</p> <p>Note: To configure multiple widgets, create a dashboard widget field object for each widget with an incremented number in the property name.</p> <p>Parameter behavior: - <i>required</i> if <i>Data set type</i> is set to "Item list" and <i>Items</i> is not set</p>
<i>Color</i>	1	ds.0.color.0	<p>Hexadecimal color code (e.g. FF0000).</p> <p>Parameter behavior: - <i>required</i> if <i>Data set type</i> is set to "Item list"</p>
<i>Host patterns</i>	1	ds.0.hosts.0	<p>Host name or pattern (e.g., "Zabbix*").</p> <p>Parameter behavior: - <i>required</i> if <i>Data set type</i> is set to "Item patterns"</p>
<i>Item patterns</i>	1	ds.0.items.0	<p>This parameter is not supported if configuring the widget on a template dashboard.</p> <p>Item name or pattern (e.g., "*: Number of processed *values per second").</p> <p>When configuring the widget on a template dashboard, only the patterns for items configured on the template should be set.</p> <p>Parameter behavior: - <i>required</i> if <i>Data set type</i> is set to "Item patterns"</p>
<i>Color</i>	1	ds.0.color	<p>Hexadecimal color code (e.g. FF0000).</p> <p>Default: FF465C.</p> <p>Parameter behavior: - <i>supported</i> if <i>Data set type</i> is set to "Item patterns"</p>
<i>Draw</i>	0	ds.0.type	<p>0 - (default) Line; 1 - Points; 2 - Staircase; 3 - Bar.</p>
<i>Stacked</i>	0	ds.0.stacked	<p>0 - (default) Disabled; 1 - Enabled.</p> <p>Parameter behavior: - <i>supported</i> if <i>Draw</i> is set to "Line", "Staircase", or "Bar"</p>
<i>Width</i>	0	ds.0.width	<p>Possible values range from 1-10.</p> <p>Default: 1.</p> <p>Parameter behavior: - <i>supported</i> if <i>Draw</i> is set to "Line" or "Staircase"</p>
<i>Point size</i>	0	ds.0.pointsize	<p>Possible values range from 1-10.</p> <p>Default: 3.</p> <p>Parameter behavior: - <i>supported</i> if <i>Draw</i> is set to "Points"</p>
<i>Transparency</i>	0	ds.0.transparency	<p>Possible values range from 1-10.</p> <p>Default: 5.</p>

Parameter	type	name	value
Fill	0	ds.0.fill	Possible values range from 1-10. Default: 3. Parameter behavior: - supported if Draw is set to "Line" or "Staircase"
Missing data	0	ds.0.missingdatafunc0	(default) None; 1 - Connected; 2 - Treat as 0; 3 - Last known. Parameter behavior: - supported if Draw is set to "Line" or "Staircase"
Override host	1	ds.0.override_hostid	ABCD - set a compatible widget (with its "Reference" parameter set to "ABCDE") as the data source for hosts; DASHBOARD._hostid - set the dashboard Host selector as the data source for hosts. This parameter is not supported if configuring the widget on a template dashboard .
Y-axis	0	ds.0.axisy	0 - (default) Left; 1 - Right.
Time shift	1	ds.0.timeshift	Valid time string (e.g. 3600, 1h, etc.). You may use time suffixes . Negative values are also allowed. Default: "" (empty).
Aggregation function	0	ds.0.aggregate_function	(default) not used; 1 - min; 2 - max; 3 - avg; 4 - count; 5 - sum; 6 - first; 7 - last.
Aggregation interval	1	ds.0.aggregate_interval	Valid time string (e.g. 3600, 1h, etc.). You may use time suffixes . Default: 1h.
Aggregate	0	ds.0.aggregate_grouping	(default) Each item; 1 - Data set. Parameter behavior: - supported if Aggregation function is set to "min", "max", "avg", "count", "sum", "first", or "last"
Approximation	0	ds.0.approximation	1 - min; 2 - (default) avg; 4 - max; 7 - all.
Data set label	1	ds.0.data_set_label	Any string value. Default: "" (empty).

Display options

The following parameters are supported for configuring *Display options*.

Parameter	type	name	value
History data selection	0	source	0 - (default) Auto; 1 - History; 2 - Trends.
Simple triggers	0	simple_triggers	0 - (default) Disabled; 1 - Enabled.
Working time	0	working_time	0 - (default) Disabled; 1 - Enabled.
Percentile line (left)			
Status	0	percentile_left	0 - (default) Disabled; 1 - Enabled.
Value	0	percentile_left_value	Possible values range from 1-100.
			Parameter behavior: - supported if Y-axis (in <i>Data set</i> configuration) is set to "Left"
Percentile line (right)			
Status	0	percentile_right	0 - (default) Disabled; 1 - Enabled.
Value	0	percentile_right_value	Possible values range from 1-100.
			Parameter behavior: - supported if Y-axis (in <i>Data set</i> configuration) is set to "Right"

Time period

The following parameters are supported for configuring *Time period*.

Parameter	type	name	value
Time period	1	time_period.reference	DASHBOARD._timeperiod - set the <i>Time period selector</i> as the data source; ABCDE._timeperiod - set a <i>compatible widget</i> (with its <i>Reference</i> parameter set to "ABCDE") as the data source.
			Default: DASHBOARD._timeperiod
From	1	time_period.from	Valid time string in absolute (YYYY-MM-DD hh:mm:ss) or <i>relative</i> time syntax (now, now/d, now/w-1w, etc.).
To	1	time_period.to	Valid time string in absolute (YYYY-MM-DD hh:mm:ss) or <i>relative</i> time syntax (now, now/d, now/w-1w, etc.).
			Parameter behavior: - supported if <i>Time period</i> is not set
			Parameter behavior: - supported if <i>Time period</i> is not set

Axes

The following parameters are supported for configuring Axes.

Parameter	type	name	value
<i>Left Y</i>	0	lefty	0 - Disabled; 1 - (default) Enabled.
<i>Right Y</i>	0	righty	<p>Parameter behavior: - supported if Y-axis (in <i>Data set</i> configuration) is set to "Left"</p> 0 - (default) Disabled; 1 - Enabled.
<i>Scale</i>	0	lefty_scale	<p>Parameter behavior: - supported if Y-axis (in <i>Data set</i> configuration) is set to "Right"</p> 0 - (default) Linear; 1 - Logarithmic.
<i>Min</i>	1	righty_scale lefty_min	Any numeric value. Default: "" (empty).
<i>Max</i>	1	righty_min lefty_max	Any numeric value. Default: "" (empty).
<i>Units (type)</i>	0	righty_max lefty_units	0 - (default) Auto; 1 - Static.
<i>Units (value)</i>	1	righty_units lefty_static_units	Any string value. Default: "" (empty).
<i>X-Axis</i>	0	righty_static_units xaxis	0 - Disabled; 1 - (default) Enabled.

Legend

The following parameters are supported for configuring Legend.

Parameter	type	name	value
<i>Show legend</i>	0	legend	0 - Disabled; 1 - (default) Enabled.
<i>Display min/avg/max</i>	0	legend_statistic	<p>Parameter behavior: - supported if <i>Show legend</i> is set to "Enabled"</p> 0 - (default) Disabled; 1 - Enabled.
<i>Show aggregation function</i>	0	legend_aggregation	<p>Parameter behavior: - supported if <i>Show legend</i> is set to "Enabled"</p> 0 - (default) Disabled; 1 - Enabled.
<i>Rows</i>	0	legend_lines_mode	<p>Parameter behavior: - supported if <i>Show legend</i> is set to "Enabled"</p> 0 - (default) Fixed; 1 - Variable.
			<p>Parameter behavior: - supported if <i>Show legend</i> is set to "Enabled"</p>

Parameter	type	name	value
Number of rows/ Maximum number of rows	0	legend_lines	Possible values range from 1-10. Default: 1. Parameter behavior: - supported if <i>Show legend</i> is set to "Enabled"
Number of columns	0	legend_columns	Possible values range from 1-4. Default: 4. Parameter behavior: - supported if <i>Show legend</i> is set to "Enabled", and <i>Display min/avg/max</i> is set to "Disabled"

Problems

The following parameters are supported for configuring *Problems*.

Parameter	type	name	value
Show prob- lems	0	show_problems	0 - (default) Disabled; 1 - Enabled.
Selected items only	0	graph_item_problems	0 - Disabled; 1 - (default) Enabled.
Problem hosts	1	problemhosts.0	Host name. Note: The number in the property name references the configured host. To configure multiple hosts, create a dashboard widget field object for each host with an incremented number in the property name. This parameter is not supported if configuring the widget on a template dashboard .
Severity	0	severities.0	0 - Not classified; 1 - Information; 2 - Warning; 3 - Average; 4 - High; 5 - Disaster. Default: empty (all enabled). Note: To configure multiple values, create a dashboard widget field object for each value with an incremented number in the property name.
Problem Problem tags	1	problem_name	Problem event name (case insensitive, full name or part of it).
Evaluation type	0	evaltype	0 - (default) And/Or; 2 - Or.
Tag name	1	tags.0.tag	Any string value. Note: The number in the property name references tag order in the tag evaluation list. Parameter behavior: - required if configuring <i>Problem tags</i>

Parameter	type	name	value
<i>Operator</i>	0	tags.0.operator	0 - Contains; 1 - Equals; 2 - Does not contain; 3 - Does not equal; 4 - Exists; 5 - Does not exist. Note: The number in the property name references tag order in the tag evaluation list. Parameter behavior: - <i>required</i> if configuring <i>Problem tags</i>
<i>Tag value</i>	1	tags.0.value	Any string value. Note: The number in the property name references tag order in the tag evaluation list. Parameter behavior: - <i>required</i> if configuring <i>Problem tags</i>

Overrides

The following parameters are supported for configuring *Overrides*.

Note:

The first number in the property name (e.g. or.0.hosts.0, or.0.items.0) represents the particular data set, while the second number, if present, represents the configured host or item.

Parameter	type	name	value
<i>Host patterns</i>	1	or.0.hosts.0	Host name or pattern (e.g. Zabbix*). This parameter is not supported if configuring the widget on a template dashboard . Parameter behavior: - <i>required</i> if configuring <i>Overrides</i>
<i>Item patterns</i>	1	or.0.items.0	Item name or pattern (e.g. *: Number of processed *values per second). When configuring the widget on a template dashboard , only the patterns for items configured on the template should be set. Parameter behavior: - <i>required</i> if configuring <i>Overrides</i>
<i>Base color</i>	1	or.0.color	Hexadecimal color code (e.g. FF0000).
<i>Width</i>	0	or.0.width	Possible values range from 1-10.
<i>Draw</i>	0	or.0.type	0 - Line; 1 - Points; 2 - Staircase; 3 - Bar.
<i>Transparency</i>	0	or.0.transparency	Possible values range from 1-10.
<i>Fill</i>	0	or.0.fill	Possible values range from 1-10.
<i>Point size</i>	0	or.0.pointsize	Possible values range from 1-10.
<i>Missing data</i>	0	or.0.missingdatafunc	0 - None; 1 - Connected; 2 - Treat as 0; 3 - Last known.
<i>Y-axis</i>	0	or.0.axisy	0 - Left; 1 - Right.

Parameter	type	name	value
<i>Time shift</i>	1	or.0.timeshift	Valid time string (e.g. 3600, 1h, etc.). You may use time suffixes . Negative values are allowed.

Examples

The following examples aim to only describe the configuration of the dashboard widget field objects for the *Graph* widget. For more information on configuring a dashboard, see [dashboard.create](#).

Configuring a *Graph* widget

Configure a *Graph* widget in the following way:

- 2 data sets for a total of 9 items on 1 host.
- The first data set is of type "Item list" and consists of 3 items that are represented by lines with a different color, but the same width, transparency, and fill.
- The second data set is of type "Item patterns", consists of 6 items, has a configured aggregation, and is represented by a line with a custom color, width, transparency, and fill.
- The second data set also has a custom data set label.
- Data in the graph are displayed for a time period of the last 3 hours.
- Problems in the graph are displayed only for the configured items.
- Graph has two Y axes of which the right Y axis displays values only for the second data set.
- Graph legend displays configured items in 4 rows, as well as minimum, maximum and average values of the data sets.

Request:

```
{
  "jsonrpc": "2.0",
  "method": "dashboard.create",
  "params": {
    "name": "My dashboard",
    "display_period": 30,
    "auto_start": 1,
    "pages": [
      {
        "widgets": [
          {
            "type": "svggraph",
            "name": "Graph",
            "x": 0,
            "y": 0,
            "width": 36,
            "height": 5,
            "view_mode": 0,
            "fields": [
              {
                "type": 0,
                "name": "ds.0.dataset_type",
                "value": 0
              },
              {
                "type": 4,
                "name": "ds.0.itemids.1",
                "value": 23264
              },
              {
                "type": 1,
                "name": "ds.0.color.1",
                "value": "FF0000"
              },
              {
                "type": 4,
                "name": "ds.0.itemids.2",
                "value": 23269
              }
            ]
          }
        ]
      }
    ]
  }
}
```

```

{
  "type": 1,
  "name": "ds.0.color.2",
  "value": "BF00FF"
},
{
  "type": 4,
  "name": "ds.0.itemids.3",
  "value": 23257
},
{
  "type": 1,
  "name": "ds.0.color.3",
  "value": "0040FF"
},
{
  "type": 0,
  "name": "ds.0.width",
  "value": 3
},
{
  "type": 0,
  "name": "ds.0.transparency",
  "value": 3
},
{
  "type": 0,
  "name": "ds.0.fill",
  "value": 1
},
{
  "type": 1,
  "name": "ds.1.hosts.0",
  "value": "Zabbix server"
},
{
  "type": 1,
  "name": "ds.1.items.0",
  "value": "*: Number of processed *values per second"
},
{
  "type": 1,
  "name": "ds.1.color",
  "value": "000000"
},
{
  "type": 0,
  "name": "ds.1.transparency",
  "value": 0
},
{
  "type": 0,
  "name": "ds.1.fill",
  "value": 0
},
{
  "type": 0,
  "name": "ds.1.axisy",
  "value": 1
},
{
  "type": 0,

```

```

        "name": "ds.1.aggregate_function",
        "value": 3
    },
    {
        "type": 1,
        "name": "ds.1.aggregate_interval",
        "value": "1m"
    },
    {
        "type": 0,
        "name": "ds.1.aggregate_grouping",
        "value": 1
    },
    {
        "type": 1,
        "name": "ds.1.data_set_label",
        "value": "Number of processed values per second"
    },
    {
        "type": 0,
        "name": "graph_time",
        "value": 1
    },
    {
        "type": 1,
        "name": "time_period.from",
        "value": "now-3h"
    },
    {
        "type": 0,
        "name": "legend_statistic",
        "value": 1
    },
    {
        "type": 0,
        "name": "legend_lines",
        "value": 4
    },
    {
        "type": 0,
        "name": "show_problems",
        "value": 1
    },
    {
        "type": 1,
        "name": "reference",
        "value": "YZABC"
    }
}
]
}
],
"userGroups": [
    {
        "usrgrpId": 7,
        "permission": 2
    }
],
"users": [
    {
        "userid": 1,

```

```

    "permission": 3
  }
]
},
"id": 1
}

```

Response:

```

{
  "jsonrpc": "2.0",
  "result": {
    "dashboardids": [
      "3"
    ]
  },
  "id": 1
}

```

See also

- [Dashboard widget field](#)
- [dashboard.create](#)
- [dashboard.update](#)

9 Graph (classic)

Description

These parameters and the possible property values for the respective dashboard widget field objects allow to configure the *Graph (classic)* widget in `dashboard.create` and `dashboard.update` methods.

Attention:

Widget fields properties are not validated during the creation or update of a dashboard. This allows users to modify **built-in widgets** and create **custom widgets**, but also introduces the risk of creating or updating widgets incorrectly. To ensure the successful creation or update of the *Graph (classic)* widget, please refer to the parameter behavior outlined in the tables below.

Parameters

The following parameters are supported for the *Graph (classic)* widget.

Parameter	type	name	value
<i>Refresh interval</i>	0	rf_rate	0 - No refresh; 10 - 10 seconds; 30 - 30 seconds; 60 - (default) 1 minute; 120 - 2 minutes; 600 - 10 minutes; 900 - 15 minutes.
<i>Source</i>	0	source_type	0 - (default) Graph; 1 - Simple graph.
<i>Graph</i>	6	graphid.0	Graph ID.

Parameter behavior:

- *required* if *Source* is set to "Graph"

Graph (Widget) 1 graphid._reference Instead of **Graph ID**:
ABCDE._graphid - set a **compatible widget** (with its *Reference* parameter set to "ABCDE") as the data source for graphs.

Parameter behavior:

- *required* if *Source* is set to "Simple graph" and *Graph* is not set

Parameter	type	name	value
<i>Item</i>	4	itemid.0	Item ID. Parameter behavior: - <i>required</i> if <i>Source</i> is set to "Simple graph" and <i>Item (Widget)</i> is not set
<i>Item (Widget)</i>	1	itemid._reference	Instead of Item ID: ABCDE._itemid - set a compatible widget (with its <i>Reference</i> parameter set to "ABCDE") as the data source for items. Parameter behavior: - <i>required</i> if <i>Source</i> is set to "Simple graph" and <i>Item</i> is not set
<i>Time period</i>	1	time_period._reference	DASHBOARD._timeperiod - set the Time period selector as the data source; ABCDE._timeperiod - set a compatible widget (with its <i>Reference</i> parameter set to "ABCDE") as the data source. Default: DASHBOARD._timeperiod Alternatively, you can set the time period only in the <i>From</i> and <i>To</i> parameters.
<i>From</i>	1	time_period.from	Valid time string in absolute (YYYY-MM-DD hh:mm:ss) or relative time syntax (now, now/d, now/w-1w, etc.). Parameter behavior: - <i>supported</i> if <i>Time period</i> is not set
<i>To</i>	1	time_period.to	Valid time string in absolute (YYYY-MM-DD hh:mm:ss) or relative time syntax (now, now/d, now/w-1w, etc.). Parameter behavior: - <i>supported</i> if <i>Time period</i> is not set
<i>Show legend</i>	0	show_legend	0 - Disabled; 1 - (<i>default</i>) Enabled.
<i>Override host</i>	1	override_hostid._reference	ABCDE._hostid - set a compatible widget (with its <i>Reference</i> parameter set to "ABCDE") as the data source for hosts; DASHBOARD._hostid - set the dashboard Host selector as the data source for hosts. This parameter is not supported if configuring the widget on a template dashboard .
<i>Reference</i>	1	reference	Any string value consisting of 5 characters (e.g., ABCDE or JBPNL). This value must be unique within the dashboard to which the widget belongs. Parameter behavior: - <i>required</i>

Examples

The following examples aim to only describe the configuration of the dashboard widget field objects for the *Graph (classic)* widget. For more information on configuring a dashboard, see [dashboard.create](#).

Configuring a *Graph (classic)* widget

Configure a *Graph (classic)* widget that displays a simple graph for the item "42269".

Request:

```
{
  "jsonrpc": "2.0",
  "method": "dashboard.create",
  "params": {
    "name": "My dashboard",
```

```

"display_period": 30,
"auto_start": 1,
"pages": [
  {
    "widgets": [
      {
        "type": "graph",
        "name": "Graph (classic)",
        "x": 0,
        "y": 0,
        "width": 36,
        "height": 5,
        "view_mode": 0,
        "fields": [
          {
            "type": 0,
            "name": "source_type",
            "value": 1
          },
          {
            "type": 4,
            "name": "itemid.0",
            "value": 42269
          },
          {
            "type": 1,
            "name": "reference",
            "value": "RSTUV"
          }
        ]
      }
    ]
  }
],
"userGroups": [
  {
    "usrgrpid": 7,
    "permission": 2
  }
],
"users": [
  {
    "userid": 1,
    "permission": 3
  }
]
},
"id": 1
}

```

Response:

```

{
  "jsonrpc": "2.0",
  "result": {
    "dashboardids": [
      "3"
    ]
  },
  "id": 1
}

```

See also

- `Dashboard widget field`
- `dashboard.create`
- `dashboard.update`

10 Graph prototype

Description

These parameters and the possible property values for the respective dashboard widget field objects allow to configure the *Graph prototype* widget in `dashboard.create` and `dashboard.update` methods.

Attention:

Widget fields properties are not validated during the creation or update of a dashboard. This allows users to modify **built-in widgets** and create **custom widgets**, but also introduces the risk of creating or updating widgets incorrectly. To ensure the successful creation or update of the *Graph prototype* widget, please refer to the parameter behavior outlined in the tables below.

Parameters

The following parameters are supported for the *Graph prototype* widget.

Parameter	type	name	value
<i>Refresh interval</i>	0	<code>rf_rate</code>	0 - No refresh; 10 - 10 seconds; 30 - 30 seconds; 60 - (default) 1 minute; 120 - 2 minutes; 600 - 10 minutes; 900 - 15 minutes.
<i>Source</i>	0	<code>source_type</code>	2 - (default) Graph prototype; 3 - Simple graph prototype.
<i>Graph prototype ID</i>	7	<code>graphid.0</code>	Graph prototype ID. Parameter behavior: - required if <i>Source</i> is set to "Graph prototype"
<i>Item prototype ID</i>	5	<code>itemid.0</code>	Item prototype ID. Parameter behavior: - required if <i>Source</i> is set to "Simple graph prototype"
<i>Time period</i>	1	<code>time_period.reference</code>	DASHBOARD._timeperiod - set the Time period selector as the data source; ABCDE._timeperiod - set a compatible widget (with its <i>Reference</i> parameter set to "ABCDE") as the data source. Default: DASHBOARD._timeperiod Alternatively, you can set the time period only in the <i>From</i> and <i>To</i> parameters.
<i>From</i>	1	<code>time_period.from</code>	Valid time string in absolute (YYYY-MM-DD hh:mm:ss) or relative time syntax (now, now/d, now/w-1w, etc.). Parameter behavior: - supported if <i>Time period</i> is not set
<i>To</i>	1	<code>time_period.to</code>	Valid time string in absolute (YYYY-MM-DD hh:mm:ss) or relative time syntax (now, now/d, now/w-1w, etc.). Parameter behavior: - supported if <i>Time period</i> is not set
<i>Show legend</i>	0	<code>show_legend</code>	0 - Disabled; 1 - (default) Enabled.

Parameter	type	name	value
<i>Override host</i>	1	override_hostid.	<p>reference: ABCDE._hostid - set a compatible widget (with its <i>Reference</i> parameter set to "ABCDE") as the data source for hosts; DASHBOARD._hostid - set the dashboard Host selector as the data source for hosts.</p> <p>This parameter is not supported if configuring the widget on a template dashboard. Possible values range from 1-24.</p>
<i>Columns</i>	0	columns	<p>Default: 2. Possible values range from 1-16.</p>
<i>Rows</i>	0	rows	<p>Default: 1. Possible values range from 1-16.</p>
<i>Reference</i>	1	reference	<p>Default: 1. Any string value consisting of 5 characters (e.g., ABCDE or JBPNL). This value must be unique within the dashboard to which the widget belongs.</p> <p>Parameter behavior: - <i>required</i></p>

Examples

The following examples aim to only describe the configuration of the dashboard widget field objects for the *Graph prototype* widget. For more information on configuring a dashboard, see [dashboard.create](#).

Configuring a *Graph prototype* widget

Configure a *Graph prototype* widget that displays a grid of 3 graphs (3 columns, 1 row) created from an item prototype (ID: "42316") by low-level discovery.

Request:

```
{
  "jsonrpc": "2.0",
  "method": "dashboard.create",
  "params": {
    "name": "My dashboard",
    "display_period": 30,
    "auto_start": 1,
    "pages": [
      {
        "widgets": [
          {
            "type": "graphprototype",
            "name": "Graph prototype",
            "x": 0,
            "y": 0,
            "width": 48,
            "height": 5,
            "view_mode": 0,
            "fields": [
              {
                "type": 0,
                "name": "source_type",
                "value": 3
              },
              {
                "type": 5,
                "name": "itemid.0",
                "value": 42316
              },
              {
                "type": 0,
```

```

        "name": "columns",
        "value": 3
      },
      {
        "type": 1,
        "name": "reference",
        "value": "OPQWX"
      }
    ]
  },
  "userGroups": [
    {
      "usrgrpid": 7,
      "permission": 2
    }
  ],
  "users": [
    {
      "userid": 1,
      "permission": 3
    }
  ]
},
"id": 1
}

```

Response:

```

{
  "jsonrpc": "2.0",
  "result": {
    "dashboardids": [
      "3"
    ]
  },
  "id": 1
}

```

See also

- [Dashboard widget field](#)
- [dashboard.create](#)
- [dashboard.update](#)

11 Honeycomb

Description

These parameters and the possible property values for the respective dashboard widget field objects allow to configure the *Honeycomb* widget in `dashboard.create` and `dashboard.update` methods.

Attention:

Widget fields properties are not validated during the creation or update of a dashboard. This allows users to modify **built-in widgets** and create **custom widgets**, but also introduces the risk of creating or updating widgets incorrectly. To ensure the successful creation or update of the *Honeycomb* widget, please refer to the parameter behavior outlined in the tables below.

Parameters

The following parameters are supported for the *Honeycomb* widget.

Parameter	type	name	value
<i>Refresh interval</i>	0	rf_rate	0 - No refresh; 10 - 10 seconds; 30 - 30 seconds; 60 - (default) 1 minute; 120 - 2 minutes; 600 - 10 minutes; 900 - 15 minutes.
<i>Host groups</i>	2	groupids.0	Host group ID. Note: To configure multiple host groups, create a dashboard widget field object for each host group with an incremented number in the property name. This parameter is not supported if configuring the widget on a template dashboard.
<i>Host groups (Widget)</i>	1	groupids._reference	Instead of Host group ID: ABCDE._hostgroupids - set a compatible widget (with its <i>Reference</i> parameter set to "ABCDE") as the data source for host groups. This parameter is not supported if configuring the widget on a template dashboard.
<i>Hosts</i>	3	hostids.0	Host ID. Note: To configure multiple hosts, create a dashboard widget field object for each host with an incremented number in the property name. For multiple hosts, the parameter <i>Host groups</i> must either be not configured at all or configured with at least one host group that the configured hosts belong to. This parameter is not supported if configuring the widget on a template dashboard.
<i>Hosts (Widget/Dashboard)</i>	1	hostids._reference	Instead of Host ID: DASHBOARD.hostids - set the Host selector as the data source for hosts; ABCDE._hostids - set a compatible widget (with its <i>Reference</i> parameter set to "ABCDE") as the data source for hosts. This parameter is not supported if configuring the widget on a template dashboard.
<i>Host tags Evaluation type</i>	0	evaltype_host	0 - (default) And/Or; 2 - Or.
<i>Tag name</i>	1	host_tags.0.tag	Any string value. Note: The number in the property name references tag order in the tag evaluation list. Parameter behavior: - <i>required</i> if configuring <i>Host tags</i> This parameter is not supported if configuring the widget on a template dashboard.

Parameter	type	name	value
<i>Operator</i>	0	host_tags.0.operator	<p>0 - Contains; 1 - Equals; 2 - Does not contain; 3 - Does not equal; 4 - Exists; 5 - Does not exist.</p> <p>Note: The number in the property name references tag order in the tag evaluation list.</p> <p>Parameter behavior: - <i>required</i> if configuring <i>Host tags</i></p> <p>This parameter is not supported if configuring the widget on a template dashboard.</p>
<i>Tag value</i>	1	host_tags.0.value	<p>Any string value.</p> <p>Note: The number in the property name references tag order in the tag evaluation list.</p> <p>Parameter behavior: - <i>required</i> if configuring <i>Host tags</i></p> <p>This parameter is not supported if configuring the widget on a template dashboard.</p>
<i>Item patterns</i>	1	items.0	<p>Item name or pattern.</p> <p>Note: To configure multiple item patterns, create a dashboard widget field object for each item pattern with an incremented number in the property name.</p> <p>Parameter behavior: - <i>required</i></p>
<i>Item tags</i>			
<i>Evaluation type</i>	0	evaltype_item	<p>0 - (default) And/Or; 2 - Or.</p>
<i>Tag name</i>	1	item_tags.0.tag	<p>Any string value.</p> <p>Note: The number in the property name references tag order in the tag evaluation list.</p> <p>Parameter behavior: - <i>required</i> if configuring <i>Item tags</i></p>
<i>Operator</i>	0	item_tags.0.operator	<p>0 - Contains; 1 - Equals; 2 - Does not contain; 3 - Does not equal; 4 - Exists; 5 - Does not exist.</p> <p>Note: The number in the property name references tag order in the tag evaluation list.</p> <p>Parameter behavior: - <i>required</i> if configuring <i>Item tags</i></p>

Parameter	type	name	value
<i>Tag value</i>	1	item_tags.0.value	Any string value. Note: The number in the property name references tag order in the tag evaluation list. Parameter behavior: - <i>required</i> if configuring <i>Item tags</i>
<i>Show hosts in maintenance Show</i>	0	maintenance	0 - (<i>default</i>) Disabled; 1 - Enabled.
	0	show.0	1 - Primary label; 2 - Secondary label. Note: To configure multiple values, create a dashboard widget field object for each value with an incremented number in the property name.
<i>Reference</i>	1	reference	Default: 1, 2. Any string value consisting of 5 characters (e.g., ABCDE or JBPNL). This value must be unique within the dashboard to which the widget belongs. Parameter behavior: - <i>required</i>

Advanced configuration

The following advanced configuration parameters are supported for the *Honeycomb* widget.

Note:

The number in the *Thresholds* property name (e.g. thresholds.0.color) references the threshold place in a list, sorted in ascending order. However, if thresholds are configured in a different order, the values will be sorted in ascending order after updating widget configuration in Zabbix frontend (e.g. "thresholds.0.threshold": "5" → "thresholds.0.threshold": "1"; "thresholds.1.threshold": "1" → "thresholds.1.threshold": "5").

Parameter	type	name	value
Primary label			
<i>Type</i>	0	primary_label_type	0 - (<i>default</i>) Text; 1 - Value.
<i>Text</i>	1	primary_label	Any string value, including macros. Supported macros: {HOST.*}, {ITEM.*}, {INVENTORY.*}, user macros. Default: {HOST.NAME} Parameter behavior: - <i>supported</i> if <i>Type</i> is set to "Text"
<i>Decimal places</i>	0	primary_label_decimal_places	Possible values range from 0-6. Default: 2. Parameter behavior: - <i>supported</i> if <i>Type</i> is set to "Value"
<i>Size (type)</i>	0	primary_label_size_type	0 - (<i>default</i>) Auto; 1 - Custom.

Parameter	type	name	value
<i>Size</i>	0	primary_label_size	Possible values range from 1-100. Default: 20. Parameter behavior: - <i>supported</i> if <i>Size</i> (type) is set to "Custom"
<i>Bold</i>	0	primary_label_bold	0 - (default) Disabled; 1 - Enabled.
<i>Color</i>	1	primary_label_color	Hexadecimal color code (e.g. FF0000). Default: based on theme of Settings object and User object : 1F2C33 for "blue-theme" or "hc-light"; EEEEEE for "dark-theme" or "hc-dark".
<i>Units (checkbox)</i>	0	primary_label_units_show	0 - Disabled; 1 - (default) Enabled. Parameter behavior: - <i>supported</i> if <i>Type</i> is set to "Value"
<i>Units (value)</i>	1	primary_label_units	Any string value. "" (empty) Parameter behavior: - <i>supported</i> if <i>Type</i> is set to "Value" and <i>Units (checkbox)</i> is set to "Enabled"
<i>Position</i>	0	primary_label_units_pos	0 - Before value; 1 - (default) After value. Parameter behavior: - <i>supported</i> if <i>Type</i> is set to "Value" and <i>Units (checkbox)</i> is set to "Enabled"
Secondary label			This parameter is ignored if set to one of the following time-related units : unixtime, uptime, s.
<i>Type</i>	0	secondary_label_type	0 - Text; 1 - (default) Value.
<i>Text</i>	1	secondary_label	Any string value, including macros. Supported macros: {HOST.*}, {ITEM.*}, {INVENTORY.*}, user macros. Default: {{ITEM.LASTVALUE}.fmtnum(2)} Parameter behavior: - <i>supported</i> if <i>Type</i> is set to "Text"
<i>Decimal places</i>	0	secondary_label_decimal_places	Possible values range from 0-6. Default: 2. Parameter behavior: - <i>supported</i> if <i>Type</i> is set to "Value"
<i>Size (type)</i>	0	secondary_label_size_type	0 (default) Auto; 1 - Custom.
<i>Size</i>	0	secondary_label_size	Possible values range from 1-100. Default: 30. Parameter behavior: - <i>supported</i> if <i>Size (type)</i> is set to "Custom"
<i>Bold</i>	0	secondary_label_bold	0 - Disabled; 1 - (default) Enabled.

Parameter	type	name	value
<i>Color</i>	1	secondary_label_color	Hexadecimal color code (e.g. FF0000). Default: based on theme of Settings object and User object : 1F2C33 for "blue-theme" or "hc-light"; EEEEEE for "dark-theme" or "hc-dark".
<i>Units (checkbox)</i>	0	secondary_label_units_show	0 - Disabled; 1 - (<i>default</i>) Enabled. Parameter behavior: - <i>supported</i> if <i>Type</i> is set to "Value"
<i>Units (value)</i>	1	secondary_label_units	Any string value. "" (empty) Parameter behavior: - <i>supported</i> if <i>Type</i> is set to "Value" and <i>Units (checkbox)</i> is set to "Enabled"
<i>Position</i>	0	secondary_label_position	0 - Before value; 1 - (<i>default</i>) After value. Parameter behavior: - <i>supported</i> if <i>Type</i> is set to "Value" and <i>Units (checkbox)</i> is set to "Enabled" This parameter is ignored if set to one of the following time-related units : unixtime, uptime, s.
Background color			
<i>Background color</i>	1	bg_color	Hexadecimal color code (e.g. FF0000). Default: based on theme of Settings object and User object : D9E7ED for "blue-theme"; 3D5059 for "dark-theme"; AAD7E9 for "hc-light"; 335463 for "hc-dark".
Thresholds			
<i>Color interpolation</i>	0	interpolation	0 - Disabled; 1 - (<i>default</i>) Enabled.
<i>Color</i>	1	thresholds.0.color	Hexadecimal color code (e.g. FF0000).
<i>Threshold</i>	1	thresholds.0.threshold	Any numeric value. Suffixes (e.g. "1d", "2w", "4K", "8G") are supported.

Examples

The following examples aim to only describe the configuration of the dashboard widget field objects for the *Honeycomb* widget. For more information on configuring a dashboard, see [dashboard.create](#).

Configuring a *Honeycomb* widget

Configure a *Honeycomb* widget that displays the utilization of Zabbix server processes. In addition, change the primary label of honeycomb cells and visually fine-tune the widget with thresholds.

Request:

```
{
  "jsonrpc": "2.0",
  "method": "dashboard.create",
  "params": {
    "name": "My dashboard",
    "display_period": "30",
    "auto_start": "1",
    "pages": [
      {
        "widgets": [
```

```

{
  "type": "honeycomb",
  "name": "Honeycomb",
  "x": "0",
  "y": "0",
  "width": "24",
  "height": "5",
  "view_mode": "0",
  "fields": [
    {
      "type": 2,
      "name": "groupids.0",
      "value": 4
    },
    {
      "type": 3,
      "name": "hostids.0",
      "value": 10084
    },
    {
      "type": 1,
      "name": "items.0",
      "value": "Zabbix server: Utilization*"
    },
    {
      "type": 1,
      "name": "primary_label",
      "value": "{ITEM.NAME}"
    },
    {
      "type": 1,
      "name": "thresholds.0.color",
      "value": "0EC9AC"
    },
    {
      "type": 1,
      "name": "thresholds.0.threshold",
      "value": "0"
    },
    {
      "type": 1,
      "name": "thresholds.1.color",
      "value": "FFD54F"
    },
    {
      "type": 1,
      "name": "thresholds.1.threshold",
      "value": "70"
    },
    {
      "type": 1,
      "name": "thresholds.2.color",
      "value": "FF465C"
    },
    {
      "type": 1,
      "name": "thresholds.2.threshold",
      "value": "90"
    },
    {
      "type": 1,
      "name": "reference",

```



```

        "value": "KSTMQ"
      }
    ]
  },
  "userGroups": [
    {
      "usrgrpid": 7,
      "permission": 2
    }
  ],
  "users": [
    {
      "userid": 1,
      "permission": 3
    }
  ]
},
"id": 1
}

```

Response:

```

{
  "jsonrpc": "2.0",
  "result": {
    "dashboardids": [
      "3"
    ]
  },
  "id": 1
}

```

See also

- [Dashboard widget field](#)
- [dashboard.create](#)
- [dashboard.update](#)

12 Host availability

Description

These parameters and the possible property values for the respective dashboard widget field objects allow to configure the *Host availability* widget in `dashboard.create` and `dashboard.update` methods.

Parameters

The following parameters are supported for the *Host availability* widget.

Parameter	type	name	value
<i>Refresh interval</i>	0	rf_rate	0 - No refresh; 10 - 10 seconds; 30 - 30 seconds; 60 - 1 minute; 120 - 2 minutes; 600 - 10 minutes; 900 - (<i>default</i>) 15 minutes.

Parameter	type	name	value
<i>Host groups</i>	2	groupids.0	Host group ID. Note: To configure multiple host groups, create a dashboard widget field object for each host group with an incremented number in the property name. This parameter is not supported if configuring the widget on a template dashboard .
<i>Host groups (Widget)</i>	1	groupids._reference	Instead of Host group ID : ABCDE. _hostgroupids - set a compatible widget (with its <i>Reference</i> parameter set to "ABCDE") as the data source for host groups. This parameter is not supported if configuring the widget on a template dashboard .
<i>Interface type</i>	0	interface_type.0	0 - None; 1 - Zabbix agent (passive checks); 2 - SNMP; 3 - IPMI; 4 - JMX; 5 - Zabbix agent (active checks). Default: 1, 2, 3, 4, 5 (all enabled). Note: To configure multiple values, create a dashboard widget field object for each value with an incremented number in the property name.
<i>Layout</i>	0	layout	0 - (default) Horizontal; 1 - Vertical.
<i>Show hosts in maintenance</i>	0	maintenance	0 - (default) Disabled; 1 - Enabled.
<i>Show only totals</i>	0	only_totals	0 - (default) Disabled; 1 - Enabled.

Examples

The following examples aim to only describe the configuration of the dashboard widget field objects for the *Host availability* widget. For more information on configuring a dashboard, see [dashboard.create](#).

Configuring a *Host availability* widget

Configure a *Host availability* widget that displays availability information (in a vertical layout) for hosts in host group "4" with "Zabbix agent" and "SNMP" interfaces configured.

Request:

```
{
  "jsonrpc": "2.0",
  "method": "dashboard.create",
  "params": {
    "name": "My dashboard",
    "display_period": 30,
    "auto_start": 1,
    "pages": [
      {
        "widgets": [
```

```

        "type": "hostavail",
        "name": "Host availability",
        "x": 0,
        "y": 0,
        "width": 18,
        "height": 3,
        "view_mode": 0,
        "fields": [
            {
                "type": 2,
                "name": "groupids.0",
                "value": 4
            },
            {
                "type": 0,
                "name": "interface_type",
                "value": 1
            },
            {
                "type": 0,
                "name": "interface_type",
                "value": 2
            },
            {
                "type": 0,
                "name": "layout",
                "value": 1
            }
        ]
    },
    ],
    "userGroups": [
        {
            "usrgrpid": 7,
            "permission": 2
        }
    ],
    "users": [
        {
            "userid": 1,
            "permission": 3
        }
    ]
},
"id": 1
}

```

Response:

```

{
  "jsonrpc": "2.0",
  "result": {
    "dashboardids": [
      "3"
    ]
  },
  "id": 1
}

```

See also

- [Dashboard widget field](#)

- `dashboard.create`
- `dashboard.update`

13 Host card

Description

These parameters and the possible property values for the respective dashboard widget field objects allow to configure the *Host card* widget in `dashboard.create` and `dashboard.update` methods.

Attention:

Widget fields properties are not validated during the creation or update of a dashboard. This allows users to modify **built-in widgets** and create **custom widgets**, but also introduces the risk of creating or updating widgets incorrectly. To ensure the successful creation or update of the *Host card* widget, please refer to the parameter behavior outlined in the tables below.

Parameters

The following parameters are supported for the *Host card* widget.

Parameter	type	name	value
<i>Refresh interval</i>	0	<code>rf_rate</code>	0 - No refresh; 10 - 10 seconds; 30 - 30 seconds; 60 - (default) 1 minute; 120 - 2 minutes; 600 - 10 minutes; 900 - 15 minutes.
<i>Host</i>	3	<code>hostid.0</code>	Host ID. Parameter behavior: - <i>required</i> if <i>Host (Widget/Dashboard)</i> is not set
<i>Host (Widget/Dashboard)</i>	1	<code>hostid._reference</code>	This parameter is not supported if configuring the widget on a template dashboard . Instead of Host ID : <code>DASHBOARD.hostid</code> - set the Host selector as the data source for host; <code>ABCDE._hostid</code> - set a compatible widget (with its <i>Reference</i> parameter set to "ABCDE") as the data source for host. Parameter behavior: - <i>required</i> if <i>Host</i> is not set
<i>Show suppressed problems</i>	0	<code>show_suppressed</code>	This parameter is not supported if configuring the widget on a template dashboard . 0 - (default) Disabled; 1 - Enabled.

Parameter	type	name	value
<i>Show</i>	0	sections.0	0 - Host groups; 1 - Description; 2 - Monitoring; 3 - Availability; 4 - Monitored by; 5 - Templates; 6 - Inventory; 7 - Tags.

Note: The number in the property name references section order in the section list. To configure multiple sections, create a dashboard widget field object for each section with an incremented number in the property name.

The following parameters are supported if *Show* is set to "Inventory".

Parameter	type	name	value
<i>Inventory fields</i>	0	inventory.0	Inventory ID.

Note: To configure multiple inventory fields, create a dashboard widget field object for each inventory field with an incremented number in the property name.

Examples

The following examples aim to only describe the configuration of the dashboard widget field objects for the *Host card* widget. For more information on configuring a dashboard, see [dashboard.create](#).

Configuring a *Host card* widget

Configure a *Host card* widget that displays these sections: "Monitoring", "Availability", "Monitored by", "Inventory", and "Tags".

Request:

```
{
  "jsonrpc": "2.0",
  "method": "dashboard.create",
  "params": {
    "name": "My dashboard",
    "display_period": 30,
    "auto_start": 1,
    "pages": [
      {
        "widgets": [
          {
            "type": "hostcard",
            "name": "Host card",
            "x": 0,
            "y": 0,
            "width": 14,
            "height": 7,
            "view_mode": 0,
            "fields": [
              {
                "type": 3,
                "name": "hostid.0",
                "value": 10084
              },
              {
                "type": 0,
                "name": "show_suppressed",
                "value": 1
              }
            ]
          }
        ]
      }
    ]
  }
}
```

```

    },
    {
      "type": 0,
      "name": "sections.0",
      "value": 2
    },
    {
      "type": 0,
      "name": "sections.1",
      "value": 3
    },
    {
      "type": 0,
      "name": "sections.2",
      "value": 4
    },
    {
      "type": 0,
      "name": "sections.3",
      "value": 6
    },
    {
      "type": 0,
      "name": "sections.4",
      "value": 7
    },
    {
      "type": 0,
      "name": "inventory.0",
      "value": 25
    },
    {
      "type": 0,
      "name": "inventory.1",
      "value": 26
    }
  ]
}
]
}
],
"userGroups": [
  {
    "usrgrpId": 7,
    "permission": 2
  }
],
"users": [
  {
    "userid": 1,
    "permission": 3
  }
]
},
"id": 1
}

```

Response:

```

{
  "jsonrpc": "2.0",
  "result": {
    "dashboardids": [

```

```

    "3"
  ],
  },
  "id": 1
}

```

See also

- [Dashboard widget field](#)
- [dashboard.create](#)
- [dashboard.update](#)

14 Host navigator

Description

These parameters and the possible property values for the respective dashboard widget field objects allow to configure the *Host navigator* widget in `dashboard.create` and `dashboard.update` methods.

Attention:

Widget fields properties are not validated during the creation or update of a dashboard. This allows users to modify **built-in widgets** and create **custom widgets**, but also introduces the risk of creating or updating widgets incorrectly. To ensure the successful creation or update of the *Host navigator* widget, please refer to the parameter behavior outlined in the tables below.

Parameters

The following parameters are supported for the *Host navigator* widget.

Parameter	type	name	value
<i>Refresh interval</i>	0	rf_rate	0 - No refresh; 10 - 10 seconds; 30 - 30 seconds; 60 - (default) 1 minute; 120 - 2 minutes; 600 - 10 minutes; 900 - 15 minutes.
<i>Host groups</i>	2	groupids.0	Host group ID.
<i>Host groups (Widget)</i>	1	groupids._reference	<p>Note: To configure multiple host groups, create a dashboard widget field object for each host group with an incremented number in the property name.</p> <p>This parameter is not supported if configuring the widget on a template dashboard.</p> <p>Instead of Host group ID: ABCDE._hostgroupids - set a compatible widget (with its <i>Reference</i> parameter set to "ABCDE") as the data source for host groups.</p> <p>This parameter is not supported if configuring the widget on a template dashboard.</p>

Parameter	type	name	value
<i>Host patterns</i>	1	hosts.0	<p>Host name or pattern.</p> <p>Note: To configure multiple host patterns, create a dashboard widget field object for each host pattern with an incremented number in the property name. For multiple host patterns, the parameter <i>Host groups</i> must either be not configured at all or configured with at least one host group that the hosts matching the configured host patterns belong to.</p> <p>This parameter is not supported if configuring the widget on a template dashboard.</p>
<i>Host status</i>	0	status	<p>-1 - (default) Any; 0 - Enabled; 1 - Disabled.</p> <p>This parameter is not supported if configuring the widget on a template dashboard.</p>
<i>Host tags Evaluation type</i>	0	host_tags_evaltype	<p>0 - (default) And/Or; 2 - Or.</p> <p>This parameter is not supported if configuring the widget on a template dashboard.</p>
<i>Tag name</i>	1	host_tags.0.tag	<p>Any string value.</p> <p>Note: The number in the property name references tag order in the tag evaluation list.</p> <p>Parameter behavior: - <i>required</i> if configuring <i>Host tags</i></p> <p>This parameter is not supported if configuring the widget on a template dashboard.</p>
<i>Operator</i>	0	host_tags.0.operator	<p>0 - Contains; 1 - Equals; 2 - Does not contain; 3 - Does not equal; 4 - Exists; 5 - Does not exist.</p> <p>Note: The number in the property name references tag order in the tag evaluation list.</p> <p>Parameter behavior: - <i>required</i> if configuring <i>Host tags</i></p>
<i>Tag value</i>	1	host_tags.0.value	<p>Any string value.</p> <p>Note: The number in the property name references tag order in the tag evaluation list.</p> <p>Parameter behavior: - <i>required</i> if configuring <i>Host tags</i></p> <p>This parameter is not supported if configuring the widget on a template dashboard.</p>

Parameter	type	name	value
Severity	0	severities.0	0 - Not classified; 1 - Information; 2 - Warning; 3 - Average; 4 - High; 5 - Disaster. Default: empty (all enabled). Note: To configure multiple values, create a dashboard widget field object for each value with an incremented number in the property name.
Show hosts in maintenance	0	maintenance	0 - (default) Disabled; 1 - Enabled.
Show problems	0	show_problems	0 - All; 1 - (default) Unsuppressed; 2 - None.
Group by	0	group_by.0.attribute	0 - Host group; 1 - Tag value; 2 - Severity. Note: The number in the property name references attribute order in the grouping attribute list. Parameter behavior: - required if configuring <i>Group by</i>
Attribute	0	group_by.0.attribute	0 - Host group; 1 - Tag value; 2 - Severity. Note: The number in the property name references attribute order in the grouping attribute list. Parameter behavior: - required if configuring <i>Group by</i>
Value	1	group_by.0.tag_name	Any string value. Note: The number in the property name references the grouping attribute set in the <i>Attribute</i> parameter. Parameter behavior: - required if configuring <i>Group by</i> and <i>Attribute</i> is set to "Tag value" Possible values range from 1-9999.
Host limit	0	show_lines	Possible values range from 1-9999. Default: 100. This parameter is not supported if configuring the widget on a template dashboard .
Reference	1	reference	Any string value consisting of 5 characters (e.g., ABCDE or JBPNL). This value must be unique within the dashboard to which the widget belongs. Parameter behavior: - required

Examples

The following examples aim to only describe the configuration of the dashboard widget field objects for the *Host navigator* widget. For more information on configuring a dashboard, see [dashboard.create](#).

Configuring a *Host navigator* widget

Configure a *Host navigator* widget that displays hosts grouped by their host group and, then, by the "city" tag value.

Request:

```

{
  "jsonrpc": "2.0",
  "method": "dashboard.create",
  "params": {
    "name": "My dashboard",
    "display_period": "30",
    "auto_start": "1",
    "pages": [
      {
        "widgets": [
          {
            "type": "hostnavigator",
            "name": "Host navigator",
            "x": "0",
            "y": "0",
            "width": "12",
            "height": "5",
            "view_mode": "0",
            "fields": [
              {
                "type": 2,
                "name": "groupids.0",
                "value": 2
              },
              {
                "type": 2,
                "name": "groupids.1",
                "value": 4
              },
              {
                "type": 0,
                "name": "group_by.0.attribute",
                "value": 0
              },
              {
                "type": 0,
                "name": "group_by.1.attribute",
                "value": 1
              },
              {
                "type": 1,
                "name": "group_by.1.tag_name",
                "value": "city"
              },
              {
                "type": 1,
                "name": "reference",
                "value": "SWKLB"
              }
            ]
          }
        ]
      }
    ],
    "userGroups": [
      {
        "usrgrp_id": 7,
        "permission": 2
      }
    ],
    "users": [
      {

```

```

        "userid": 1,
        "permission": 3
    }
]
},
"id": 1
}

```

Response:

```

{
  "jsonrpc": "2.0",
  "result": {
    "dashboardids": [
      "3"
    ]
  },
  "id": 1
}

```

See also

- [Dashboard widget field](#)
- [dashboard.create](#)
- [dashboard.update](#)

15 Item history

Description

These parameters and the possible property values for the respective dashboard widget field objects allow to configure the *Item history* widget in `dashboard.create` and `dashboard.update` methods.

Attention:

Widget fields properties are not validated during the creation or update of a dashboard. This allows users to modify **built-in widgets** and create **custom widgets**, but also introduces the risk of creating or updating widgets incorrectly. To ensure the successful creation or update of the *Item history* widget, please refer to the parameter behavior outlined in the tables below.

Parameters

The following parameters are supported for the *Item history* widget.

Parameter	type	name	value
<i>Refresh interval</i>	0	rf_rate	0 - No refresh; 10 - 10 seconds; 30 - 30 seconds; 60 - (default) 1 minute; 120 - 2 minutes; 600 - 10 minutes; 900 - 15 minutes.
<i>Layout</i>	0	layout	0 - (default) Horizontal; 1 - Vertical.
<i>Columns</i> (see below)			
<i>Show lines</i>	0	show_lines	Possible values range from 1-100. Default: 25.

Parameter	type	name	value
<i>Override host</i>	1	override_hostid._reference	ABCDE._hostid - set a compatible widget (with its <i>Reference</i> parameter set to "ABCDE") as the data source for hosts; DASHBOARD._hostid - set the dashboard Host selector as the data source for hosts. This parameter is not supported if configuring the widget on a template dashboard .
<i>Advanced configuration (see below)</i>			
<i>Reference</i>	1	reference	Any string value consisting of 5 characters (e.g., ABCDE or JBPNL). This value must be unique within the dashboard to which the widget belongs. Parameter behavior: - <i>required</i>

Columns

Columns have common parameters and additional parameters depending on the configuration of the *Item* parameter.

Note:

For all parameters related to columns, the number in the property name (e.g. columns.0.name) references a column for which the parameter is configured.

The following parameters are supported for all columns.

Parameter	type	name	value
<i>Name</i>	1	columns.0.name	Any string value. Parameter behavior: - <i>required</i>
<i>Item</i>	4	columns.0.itemid	Item ID . When configuring the widget on a template dashboard , only items configured on the template should be set. Parameter behavior: - <i>required</i>
<i>Base color</i>	1	columns.0.base_color	Hexadecimal color code (e.g. FF0000). Default: "" (empty).

The following column parameters are supported if the configured *Item* is a numeric type item.

Parameter	type	name	value
<i>Display</i>	0	columns.0.display	1 - (default) As is; 2 - Bar; 3 - Indicators.
<i>Min</i>	1	columns.0.min	Any numeric value. Parameter behavior: - <i>supported</i> if <i>Display</i> is set to "Bar" or "Indicators"
<i>Max</i>	1	columns.0.max	Any numeric value. Parameter behavior: - <i>supported</i> if <i>Display</i> is set to "Bar" or "Indicators"
<i>Thresholds Color</i>	1	columns.0.thresholds_color	Hexadecimal color code (e.g. FF0000).

Parameter	type	name	value
<i>Threshold</i>	1	columns.0.thresholds	Any number value. Suffixes (e.g. "1d", "2w", "4K", "8G") are supported.
<i>History data</i>	0	columns.0.history	0 - (default) Auto; 1 - History; 2 - Trends.

The following column parameters are supported if the configured *Item* is a character, text, or log type item.

Parameter	type	name	value
<i>Highlights</i>			
<i>Highlight</i>	1	columns.0.highlights	Hexadecimal color code (e.g. FF0000).
<i>Threshold</i>	1	columns.0.highlights	Any regular expression.
<i>Display</i>	0	columns.0.display	1 - (default) As is; 4 - HTML; 5 - Single line.
<i>Single line</i>	0	columns.0.max_length	Possible values range from 1-500. Default: 100. Parameter behavior: - supported if <i>Display</i> is set to "Single line"
<i>Use monospace font</i>	0	columns.0.monospace_font	0 - (default) Use default font; 1 - Use monospace font.
<i>Display local time</i>	0	columns.0.local_time	0 - (default) Display timestamp; 1 - Display local time. Parameter behavior: - supported if <i>Item</i> is set to log type item, and <i>Show timestamp</i> is set to "Enabled"

The following column parameters are supported if the configured *Item* is a binary type item.

Parameter	type	name	value
<i>Show thumbnail</i>	1	columns.0.show_thumbnail	0 - (default) Disabled; 1 - Enabled.

Advanced configuration

The following advanced configuration parameters are supported for the *Item history* widget.

Parameter	type	name	value
<i>New values</i>	0	sortorder	0 - (default) Top; 1 - Bottom.
<i>Show timestamp</i>	0	show_timestamp	0 - (default) Disabled; 1 - Enabled.
<i>Show column header</i>	0	show_column_header	0 - Off; 1 - Horizontal; 2 - (default) Vertical.

Parameter	type	name	value
<i>Time period</i>	1	time_period.reference	DASHBOARD._timeperiod - set the <i>Time period selector</i> as the data source; ABCDE._timeperiod - set a <i>compatible widget</i> (with its <i>Reference</i> parameter set to "ABCDE") as the data source. Default: DASHBOARD._timeperiod Alternatively, you can set the time period only in the <i>From</i> and <i>To</i> parameters.
<i>From</i>	1	time_period.from	Valid time string in absolute (YYYY-MM-DD hh:mm:ss) or <i>relative</i> time syntax (now, now/d, now/w-1w, etc.). Parameter behavior: - <i>supported</i> if <i>Time period</i> is not set
<i>To</i>	1	time_period.to	Valid time string in absolute (YYYY-MM-DD hh:mm:ss) or <i>relative</i> time syntax (now, now/d, now/w-1w, etc.). Parameter behavior: - <i>supported</i> if <i>Time period</i> is not set

Examples

The following examples aim to only describe the configuration of the dashboard widget field objects for the *Item history* widget. For more information on configuring a dashboard, see [dashboard.create](#).

Configuring an *Item history* widget

Configure an *Item history* widget that displays latest data for two numeric items "42269" and "42270". In addition, configure the item columns to be displayed vertically, with column names displayed horizontally; limit the display to 15 lines of data and include a separate timestamp column.

Request:

```
{
  "jsonrpc": "2.0",
  "method": "dashboard.create",
  "params": {
    "name": "My dashboard",
    "display_period": 30,
    "auto_start": 1,
    "pages": [
      {
        "widgets": [
          {
            "type": "itemhistory",
            "name": "Item history",
            "x": "0",
            "y": "0",
            "width": "18",
            "height": "6",
            "view_mode": "0",
            "fields": [
              {
                "type": "0",
                "name": "layout",
                "value": "1"
              },
              {
                "type": "1",
                "name": "columns.0.name",
                "value": "CPU utilization"
              }
            ]
          }
        ]
      }
    ]
  }
}
```

```

        "type": "4",
        "name": "columns.0.itemid",
        "value": "42269"
    },
    {
        "type": "1",
        "name": "columns.1.name",
        "value": "Memory utilization"
    },
    {
        "type": "4",
        "name": "columns.1.itemid",
        "value": "42270"
    },
    {
        "type": "0",
        "name": "show_lines",
        "value": "15"
    },
    {
        "type": "0",
        "name": "show_timestamp",
        "value": "1"
    },
    {
        "type": "0",
        "name": "show_column_header",
        "value": "1"
    },
    {
        "type": "1",
        "name": "reference",
        "value": "KIVKD"
    }
}
    ]
}
    ]
},
"userGroups": [
    {
        "usrgrp": 7,
        "permission": 2
    }
],
"users": [
    {
        "userid": 1,
        "permission": 3
    }
]
},
"id": 1
}

```

Response:

```

{
  "jsonrpc": "2.0",
  "result": {
    "dashboardids": [
      "3"
    ]
  }
}

```

```

    },
    "id": 1
}

```

See also

- [Dashboard widget field](#)
- [dashboard.create](#)
- [dashboard.update](#)

16 Item navigator

Description

These parameters and the possible property values for the respective dashboard widget field objects allow to configure the *Item navigator* widget in `dashboard.create` and `dashboard.update` methods.

Attention:

Widget fields properties are not validated during the creation or update of a dashboard. This allows users to modify **built-in widgets** and create **custom widgets**, but also introduces the risk of creating or updating widgets incorrectly. To ensure the successful creation or update of the *Item navigator* widget, please refer to the parameter behavior outlined in the tables below.

Parameters

The following parameters are supported for the *Item navigator* widget.

Parameter	type	name	value
<i>Refresh interval</i>	0	rf_rate	0 - No refresh; 10 - 10 seconds; 30 - 30 seconds; 60 - (default) 1 minute; 120 - 2 minutes; 600 - 10 minutes; 900 - 15 minutes.
<i>Host groups</i>	2	groupids.0	Host group ID. Note: To configure multiple host groups, create a dashboard widget field object for each host group with an incremented number in the property name. This parameter is not supported if configuring the widget on a template dashboard .
<i>Host groups (Widget)</i>	1	groupids._reference	Instead of Host group ID : ABCDE._hostgroupids - set a compatible widget (with its <i>Reference</i> parameter set to "ABCDE") as the data source for host groups. This parameter is not supported if configuring the widget on a template dashboard .
<i>Hosts</i>	3	hostids.0	Host ID. Note: To configure multiple hosts, create a dashboard widget field object for each host with an incremented number in the property name. For multiple hosts, the parameter <i>Host groups</i> must either be not configured at all or configured with at least one host group that the configured hosts belong to. This parameter is not supported if configuring the widget on a template dashboard .

Parameter	type	name	value
<i>Hosts (Widget/Dashboard)</i>	1	hostids._reference	<p>Instead of Host ID: DASHBOARD.hostid - set the Host selector as the data source for hosts; ABCDE._hostid - set a compatible widget (with its <i>Reference</i> parameter set to "ABCDE") as the data source for hosts.</p> <p>This parameter is not supported if configuring the widget on a template dashboard.</p>
<i>Host tags</i>			
<i>Evaluation type</i>	0	host_tags_evaltype	<p>0 - (default) And/Or; 2 - Or.</p> <p>This parameter is not supported if configuring the widget on a template dashboard.</p>
<i>Tag name</i>	1	host_tags.0.tag	<p>Any string value.</p> <p>Note: The number in the property name references tag order in the tag evaluation list.</p> <p>Parameter behavior: - <i>required</i> if configuring <i>Host tags</i></p> <p>This parameter is not supported if configuring the widget on a template dashboard.</p>
<i>Operator</i>	0	host_tags.0.operator	<p>0 - Contains; 1 - Equals; 2 - Does not contain; 3 - Does not equal; 4 - Exists; 5 - Does not exist.</p> <p>Note: The number in the property name references tag order in the tag evaluation list.</p> <p>Parameter behavior: - <i>required</i> if configuring <i>Host tags</i></p> <p>This parameter is not supported if configuring the widget on a template dashboard.</p>
<i>Tag value</i>	1	host_tags.0.value	<p>Any string value.</p> <p>Note: The number in the property name references tag order in the tag evaluation list.</p> <p>Parameter behavior: - <i>required</i> if configuring <i>Host tags</i></p> <p>This parameter is not supported if configuring the widget on a template dashboard.</p>
<i>Item patterns</i>	1	items.0	<p>Item name or pattern.</p> <p>Note: To configure multiple item patterns, create a dashboard widget field object for each item pattern with an incremented number in the property name.</p>
<i>Item tags</i>			
<i>Evaluation type</i>	0	item_tags_evaltype	<p>0 - (default) And/Or; 2 - Or.</p>

Parameter	type	name	value
<i>Tag name</i>	1	item_tags.0.tag	Any string value. Note: The number in the property name references tag order in the tag evaluation list. Parameter behavior: - <i>required</i> if configuring <i>Item tags</i>
<i>Operator</i>	0	item_tags.0.operator	0 - Contains; 1 - Equals; 2 - Does not contain; 3 - Does not equal; 4 - Exists; 5 - Does not exist. Note: The number in the property name references tag order in the tag evaluation list. Parameter behavior: - <i>required</i> if configuring <i>Item tags</i>
<i>Tag value</i>	1	item_tags.0.value	Any string value. Note: The number in the property name references tag order in the tag evaluation list. Parameter behavior: - <i>required</i> if configuring <i>Item tags</i>
<i>State</i>	0	state	-1 - (<i>default</i>) All; 0 - Normal; 1 - Not supported.
<i>Show problems Group by</i>	0	show_problems	0 - All; 1 - (<i>default</i>) Unsuppressed; 2 - None.
<i>Attribute</i>	0	group_by.0.attribute	0 - Host group; 1 - Host name; 2 - Host tag value; 3 - Item tag value. Note: The number in the property name references attribute order in the grouping attribute list. Parameter behavior: - <i>required</i> if configuring <i>Group by</i>
<i>Value</i>	1	group_by.0.tag_name	Any string value. Note: The number in the property name references the grouping attribute set in the <i>Attribute</i> parameter. Parameter behavior: - <i>required</i> if configuring <i>Group by</i> and <i>Attribute</i> is set to "Host tag value" or "Item tag value"
<i>Item limit</i>	0	show_lines	Possible values range from 1-9999. Default: 100.
<i>Reference</i>	1	reference	Any string value consisting of 5 characters (e.g., ABCDE or JBPNL). This value must be unique within the dashboard to which the widget belongs. Parameter behavior: - <i>required</i>

Examples

The following examples aim to only describe the configuration of the dashboard widget field objects for the *Item navigator* widget. For more information on configuring a dashboard, see [dashboard.create](#).

Configuring an *Item navigator* widget

Configure an *Item navigator* widget that displays up to 1000 items grouped by their host and, then, by the "component" item tag value.

Request:

```
{
  "jsonrpc": "2.0",
  "method": "dashboard.create",
  "params": {
    "name": "My dashboard",
    "display_period": "30",
    "auto_start": "1",
    "pages": [
      {
        "widgets": [
          {
            "type": "itemnavigator",
            "name": "Item navigator",
            "x": "0",
            "y": "0",
            "width": "12",
            "height": "5",
            "view_mode": "0",
            "fields": [
              {
                "type": 0,
                "name": "group_by.0.attribute",
                "value": 0
              },
              {
                "type": 0,
                "name": "group_by.1.attribute",
                "value": 3
              },
              {
                "type": 1,
                "name": "group_by.1.tag_name",
                "value": "component"
              },
              {
                "type": 0,
                "name": "show_lines",
                "value": 1000
              },
              {
                "type": 1,
                "name": "reference",
                "value": "DFNLK"
              }
            ]
          }
        ]
      }
    ],
    "userGroups": [
      {
        "usrgrp_id": 7,
        "permission": 2
      }
    ]
  }
}
```

```

    }
  ],
  "users": [
    {
      "userid": 1,
      "permission": 3
    }
  ]
},
"id": 1
}

```

Response:

```

{
  "jsonrpc": "2.0",
  "result": {
    "dashboardids": [
      "3"
    ]
  },
  "id": 1
}

```

See also

- [Dashboard widget field](#)
- [dashboard.create](#)
- [dashboard.update](#)

17 Item value

Description

These parameters and the possible property values for the respective dashboard widget field objects allow to configure the *Item value* widget in `dashboard.create` and `dashboard.update` methods.

Attention:

Widget fields properties are not validated during the creation or update of a dashboard. This allows users to modify **built-in widgets** and create **custom widgets**, but also introduces the risk of creating or updating widgets incorrectly. To ensure the successful creation or update of the *Item value* widget, please refer to the parameter behavior outlined in the tables below.

Parameters

The following parameters are supported for the *Item value* widget.

Parameter	type	name	value
<i>Refresh in-ter-val</i>	0	rf_rate	0 - No refresh; 10 - 10 seconds; 30 - 30 seconds; 60 - (default) 1 minute; 120 - 2 minutes; 600 - 10 minutes; 900 - 15 minutes.
<i>Item</i>	4	itemid.0	Item ID.

Parameter behavior:
- required if *Item (Widget)* is not set

Parameter	type	name	value
<i>Item (Widget)</i>	1	itemid._reference	Instead of Item ID: ABCDE._itemid - set a compatible widget (with its <i>Reference</i> parameter set to "ABCDE") as the data source for items.
<i>Show</i>	0	show.0	<p>Parameter behavior:</p> <ul style="list-style-type: none"> - <i>required</i> if <i>Item</i> is not set 1 - Description; 2 - Value; 3 - Time; 4 - Change indicator; 5 - Sparkline. <p>Default: 1, 2, 3, 4.</p> <p>Note: To configure multiple values, create a dashboard widget field object for each value with an incremented number in the property name.</p>
<i>Override host</i>	1	override_hostid._reference	<p>ABCDE._hostid - set a compatible widget (with its <i>Reference</i> parameter set to "ABCDE") as the data source for hosts; DASHBOARD._hostid - set the dashboard Host selector as the data source for hosts.</p> <p>This parameter is not supported if configuring the widget on a template dashboard.</p>

Advanced configuration

The following advanced configuration parameters are supported for the *Item value* widget.

Note:

The number in the *Thresholds* property name (e.g. thresholds.0.color) references the threshold place in a list, sorted in ascending order. However, if thresholds are configured in a different order, the values will be sorted in ascending order after updating widget configuration in Zabbix frontend (e.g. "thresholds.0.threshold": "5" → "thresholds.0.threshold": "1"; "thresholds.1.threshold": "1" → "thresholds.1.threshold": "5").

Parameter	type	name	value
<i>Background color</i>	1	bg_color	Hexadecimal color code (e.g. FF0000). Default: "" (empty).
<i>Thresholds</i>			
<i>Color</i>	1	thresholds.0.color	Hexadecimal color code (e.g. FF0000).
<i>Threshold</i>	1	thresholds.0.threshold	Any string value.
<i>Aggregation function</i>	0	aggregate_function	0 - (<i>default</i>) not used; 1 - min; 2 - max; 3 - avg; 4 - count; 5 - sum; 6 - first; 7 - last.

Parameter	type	name	value
<i>Time period</i>	1	time_period.reference	DASHBOARD._timeperiod - set the <i>Time period selector</i> as the data source; ABCDE._timeperiod - set a <i>compatible widget</i> (with its reference parameter equal to ABCDE) as the data source. Default: DASHBOARD._timeperiod Alternatively, you can set the time period only in the <i>From</i> and <i>To</i> parameters. Parameter behavior: - <i>supported</i> if <i>Aggregation function</i> is set to "min", "max", "avg", "count", "sum", "first", "last"
<i>From</i>	1	time_period.from	Valid time string in absolute (YYYY-MM-DD hh:mm:ss) or <i>relative</i> time syntax (now, now/d, now/w-1w, etc.). Parameter behavior: - <i>supported</i> if <i>Time period</i> is not set and <i>Aggregation function</i> is set to "min", "max", "avg", "count", "sum", "first", "last"
<i>To</i>	1	time_period.to	Valid time string in absolute (YYYY-MM-DD hh:mm:ss) or <i>relative</i> time syntax (now, now/d, now/w-1w, etc.). Parameter behavior: - <i>supported</i> if <i>Time period</i> is not set and <i>Aggregation function</i> is set to "min", "max", "avg", "count", "sum", "first", "last"
<i>History data</i>	0	history	0 - (default) Auto; 1 - History; 2 - Trends.

Description

The following advanced configuration parameters are supported if *Show* is set to "Description".

Parameter	type	name	value
<i>Description</i>	1	description	Any string value, including macros. Supported macros: {HOST.*}, {ITEM.*}, {INVENTORY.*}, User macros. Default: {ITEM.NAME}.
<i>Horizontal position</i>	0	desc_h_pos	0 - Left; 1 - (default) Center; 2 - Right. Two or more elements (Description, Value, Time) cannot share the same <i>Horizontal position</i> and <i>Vertical position</i> .
<i>Vertical position</i>	0	desc_v_pos	0 - Top; 1 - Middle; 2 - (default) Bottom. Two or more elements (Description, Value, Time) cannot share the same <i>Horizontal position</i> and <i>Vertical position</i> .
<i>Size</i>	0	desc_size	Possible values range from 1-100. Default: 15.
<i>Bold</i>	0	desc_bold	0 - (default) Disabled; 1 - Enabled.
<i>Color</i>	1	desc_color	Hexadecimal color code (e.g. FF0000). Default: "" (empty).

Value

The following advanced configuration parameters are supported if *Show* is set to "Value".

Parameter	type	name	value
<i>Decimal places</i>			
<i>Decimal places</i>	0	decimal_places	Possible values range from 1-10. Default: 2.
<i>Size</i>	0	decimal_size	Possible values range from 1-100. Default: 35.
<i>Position</i>			
<i>Horizontal position</i>	0	value_h_pos	0 - Left; 1 - (default) Center; 2 - Right.
<i>Vertical position</i>	0	value_v_pos	Two or more elements (Description, Value, Time) cannot share the same <i>Horizontal position</i> and <i>Vertical position</i> . 0 - Top; 1 - (default) Middle; 2 - Bottom.
<i>Size</i>	0	value_size	Two or more elements (Description, Value, Time) cannot share the same <i>Horizontal position</i> and <i>Vertical position</i> . Possible values range from 1-100. Default: 45.
<i>Bold</i>	0	value_bold	0 - Disabled; 1 - (default) Enabled.
<i>Color</i>	1	value_color	Hexadecimal color code (e.g. FF0000). Default: "" (empty).
<i>Units</i>			
<i>Units (checkbox)</i>	0	units_show	0 - Disabled; 1 - (default) Enabled.
<i>Units (value)</i>	1	units	Any string value.
<i>Position</i>	0	units_pos	0 - Before value; 1 - Above value; 2 - (default) After value; 3 - Below value.
<i>Size</i>	0	units_size	Possible values range from 1-100. Default: 35.
<i>Bold</i>	0	units_bold	0 - Disabled; 1 - (default) Enabled.
<i>Color</i>	1	units_color	Hexadecimal color code (e.g. FF0000). Default: "" (empty).

Time

The following advanced configuration parameters are supported if *Show* is set to "Time".

Parameter	type	name	value
<i>Horizontal position</i>	0	time_h_pos	0 - Left; 1 - (default) Center; 2 - Right.
			Two or more elements (Description, Value, Time) cannot share the same <i>Horizontal position</i> and <i>Vertical position</i> .

Parameter	type	name	value
<i>Vertical position</i>	0	time_v_pos	0 - (default) Top; 1 - Middle; 2 - Bottom.
<i>Size</i>	0	time_size	Two or more elements (Description, Value, Time) cannot share the same <i>Horizontal position</i> and <i>Vertical position</i> . Possible values range from 1-100.
<i>Bold</i>	0	time_bold	Default: 15. 0 - (default) Disabled; 1 - Enabled.
<i>Color</i>	1	time_color	Hexadecimal color code (e.g. FF0000). Default: "" (empty).

Change indicator

The following advanced configuration parameters are supported if *Show* is set to "Change indicator".

Parameter	type	name	value
<i>Change indicator ↑ color</i>	1	up_color	Hexadecimal color code (e.g. FF0000). Default: "" (empty).
<i>Change indicator ↓ color</i>	1	down_color	Hexadecimal color code (e.g. FF0000). Default: "" (empty).
<i>Change indicator ⇅ color</i>	1	updown_color	Hexadecimal color code (e.g. FF0000). Default: "" (empty).

Sparkline

The following advanced configuration parameters are supported if *Show* is set to "Sparkline".

Parameter	type	name	value
<i>Width</i>	0	sparkline.width	Possible values range from 0-10.
<i>Fill</i>	0	sparkline.fill	Default: 1. Possible values range from 0-10.
<i>Color</i>	1	sparkline.color	Default: 3. Hexadecimal color code (e.g. FF0000). Default: 42A5F5.
<i>Time period</i>	1	sparkline.time_period	DASHBOARD._timeperiod - set the <i>Time period selector</i> as the data source; ABCDE._timeperiod - set a <i>compatible widget</i> (with its reference parameter equal to ABCDE) as the data source. Default: DASHBOARD._timeperiod
<i>From</i>	1	sparkline.time_period_from	Valid time string in absolute (YYYY-MM-DD hh:mm:ss) or <i>relative</i> time syntax (now, now/d, now/w-1w, etc.).
<i>To</i>	1	sparkline.time_period_to	Valid time string in absolute (YYYY-MM-DD hh:mm:ss) or <i>relative</i> time syntax (now, now/d, now/w-1w, etc.).

Parameter	type	name	value
<i>History data</i>	0	sparkline.history	0 - (default) Auto; 1 - History; 2 - Trends.

Examples

The following examples aim to only describe the configuration of the dashboard widget field objects for the *Item value* widget. For more information on configuring a dashboard, see [dashboard.create](#).

Configuring an *Item value* widget

Configure an *Item value* widget that displays the item value for the item "42266" (Zabbix agent availability). In addition, visually fine-tune the widget with multiple advanced options, including a dynamic background color that changes based on the availability status of Zabbix agent.

Request:

```
{
  "jsonrpc": "2.0",
  "method": "dashboard.create",
  "params": {
    "name": "My dashboard",
    "display_period": 30,
    "auto_start": 1,
    "pages": [
      {
        "widgets": [
          {
            "type": "item",
            "name": "Item value",
            "x": 0,
            "y": 0,
            "width": 12,
            "height": 3,
            "view_mode": 0,
            "fields": [
              {
                "type": 4,
                "name": "itemid.0",
                "value": 42266
              },
              {
                "type": 0,
                "name": "show.0",
                "value": 1
              },
              {
                "type": 0,
                "name": "show.1",
                "value": 2
              },
              {
                "type": 0,
                "name": "show.2",
                "value": 3
              },
              {
                "type": 1,
                "name": "description",
                "value": "Agent status"
              },
              {
                "type": 0,
```

```

        "name": "desc_h_pos",
        "value": 0
    },
    {
        "type": 0,
        "name": "desc_v_pos",
        "value": 0
    },
    {
        "type": 0,
        "name": "desc_bold",
        "value": 1
    },
    {
        "type": 1,
        "name": "desc_color",
        "value": "F06291"
    },
    {
        "type": 0,
        "name": "value_h_pos",
        "value": 0
    },
    {
        "type": 0,
        "name": "value_size",
        "value": 25
    },
    {
        "type": 1,
        "name": "value_color",
        "value": "FFFF00"
    },
    {
        "type": 0,
        "name": "units_show",
        "value": 0
    },
    {
        "type": 0,
        "name": "time_h_pos",
        "value": 2
    },
    {
        "type": 0,
        "name": "time_v_pos",
        "value": 2
    },
    {
        "type": 0,
        "name": "time_size",
        "value": 10
    },
    {
        "type": 0,
        "name": "time_bold",
        "value": 1
    },
    {
        "type": 1,
        "name": "time_color",
        "value": "9FA8DA"
    }

```

```

    },
    {
      "type": 1,
      "name": "thresholds.0.color",
      "value": "E1E1E1"
    },
    {
      "type": 1,
      "name": "thresholds.0.threshold",
      "value": "0"
    },
    {
      "type": 1,
      "name": "thresholds.1.color",
      "value": "D1C4E9"
    },
    {
      "type": 1,
      "name": "thresholds.1.threshold",
      "value": "1"
    }
  ]
}
],
"userGroups": [
  {
    "usrgrpid": 7,
    "permission": 2
  }
],
"users": [
  {
    "userid": 1,
    "permission": 3
  }
]
},
"id": 1
}

```

Response:

```

{
  "jsonrpc": "2.0",
  "result": {
    "dashboardids": [
      "3"
    ]
  },
  "id": 1
}

```

See also

- [Dashboard widget field](#)
- [dashboard.create](#)
- [dashboard.update](#)

18 Map

Description

These parameters and the possible property values for the respective dashboard widget field objects allow to configure the *Map* widget in `dashboard.create` and `dashboard.update` methods.

Attention:

Widget fields properties are not validated during the creation or update of a dashboard. This allows users to modify **built-in widgets** and create **custom widgets**, but also introduces the risk of creating or updating widgets incorrectly. To ensure the successful creation or update of the *Map* widget, please refer to the parameter behavior outlined in the tables below.

Parameters

The following parameters are supported for the *Map* widget.

Parameter	type	name	value
<i>Refresh interval</i>	0	rf_rate	0 - No refresh; 10 - 10 seconds; 30 - 30 seconds; 60 - 1 minute; 120 - 2 minutes; 600 - 10 minutes; 900 - (default) 15 minutes.
<i>Map</i>	8	sysmapid.0	Map ID. Parameter behavior: - required if <i>Map (Widget)</i> is not set
<i>Map (Widget)</i>	1	sysmapid._reference	ABCDE._mapid - set a Map navigation tree widget (with its <i>Reference</i> parameter set to "ABCDE") as the data source for maps. Parameter behavior: - required if <i>Map</i> is not set
<i>Reference</i>	1	reference	Any string value consisting of 5 characters (e.g., ABCDE or JBPNL). This value must be unique within the dashboard to which the widget belongs. Parameter behavior: - required

Examples

The following examples aim to only describe the configuration of the dashboard widget field objects for the *Map* widget. For more information on configuring a dashboard, see `dashboard.create`.

Configuring a *Map* widget

Configure a *Map* widget that displays the map "1".

Request:

```
{
  "jsonrpc": "2.0",
  "method": "dashboard.create",
  "params": {
    "name": "My dashboard",
    "display_period": 30,
    "auto_start": 1,
    "pages": [
      {
        "widgets": [
          {
            "type": "map",
            "name": "Map",
            "x": 0,
            "y": 0,
            "width": 54,
```

```

        "height": 5,
        "view_mode": 0,
        "fields": [
            {
                "type": 8,
                "name": "sysmapid.0",
                "value": 1
            }
        ]
    }
],
"userGroups": [
    {
        "usrgrpid": 7,
        "permission": 2
    }
],
"users": [
    {
        "userid": 1,
        "permission": 3
    }
]
},
"id": 1
}

```

Response:

```

{
  "jsonrpc": "2.0",
  "result": {
    "dashboardids": [
      "3"
    ]
  },
  "id": 1
}

```

Configuring a linked *Map* widget

Configure a *Map* widget that is linked to a *Map navigation tree* widget.

Request:

```

{
  "jsonrpc": "2.0",
  "method": "dashboard.create",
  "params": {
    "name": "My dashboard",
    "display_period": 30,
    "auto_start": 1,
    "pages": [
      {
        "widgets": [
          {
            "type": "map",
            "name": "Map",
            "x": 0,
            "y": 5,
            "width": 54,
            "height": 5,
            "view_mode": 0,

```

```

    "fields": [
      {
        "type": 1,
        "name": "sysmapid._reference",
        "value": "ABCDE._mapid"
      }
    ]
  },
  {
    "type": "navtree",
    "name": "Map navigation tree",
    "x": 0,
    "y": 0,
    "width": 18,
    "height": 5,
    "view_mode": 0,
    "fields": [
      {
        "type": 1,
        "name": "navtree.1.name",
        "value": "Element A"
      },
      {
        "type": 1,
        "name": "navtree.2.name",
        "value": "Element B"
      },
      {
        "type": 1,
        "name": "navtree.3.name",
        "value": "Element C"
      },
      {
        "type": 1,
        "name": "navtree.4.name",
        "value": "Element A1"
      },
      {
        "type": 1,
        "name": "navtree.5.name",
        "value": "Element A2"
      },
      {
        "type": 1,
        "name": "navtree.6.name",
        "value": "Element B1"
      },
      {
        "type": 1,
        "name": "navtree.7.name",
        "value": "Element B2"
      },
      {
        "type": 0,
        "name": "navtree.4.parent",
        "value": 1
      },
      {
        "type": 0,
        "name": "navtree.5.parent",
        "value": 1
      }
    ]
  },

```

```

    {
      "type": 0,
      "name": "navtree.6.parent",
      "value": 2
    },
    {
      "type": 0,
      "name": "navtree.7.parent",
      "value": 2
    },
    {
      "type": 0,
      "name": "navtree.1.order",
      "value": 1
    },
    {
      "type": 0,
      "name": "navtree.2.order",
      "value": 2
    },
    {
      "type": 0,
      "name": "navtree.3.order",
      "value": 3
    },
    {
      "type": 0,
      "name": "navtree.4.order",
      "value": 1
    },
    {
      "type": 0,
      "name": "navtree.5.order",
      "value": 2
    },
    {
      "type": 0,
      "name": "navtree.6.order",
      "value": 1
    },
    {
      "type": 0,
      "name": "navtree.7.order",
      "value": 2
    },
    {
      "type": 8,
      "name": "navtree.6.sysmapid",
      "value": 1
    },
    {
      "type": 1,
      "name": "reference",
      "value": "ABCDE"
    }
  ]
},
"userGroups": [
  {

```

```

        "usrgrp": 7,
        "permission": 2
    }
],
"users": [
    {
        "userid": 1,
        "permission": 3
    }
]
},
"id": 1
}

```

Response:

```

{
  "jsonrpc": "2.0",
  "result": {
    "dashboardids": [
      "3"
    ]
  },
  "id": 1
}

```

See also

- [Dashboard widget field](#)
- [dashboard.create](#)
- [dashboard.update](#)
- [Map navigation tree](#)

19 Map navigation tree

Description

These parameters and the possible property values for the respective dashboard widget field objects allow to configure the *Map navigation tree* widget in `dashboard.create` and `dashboard.update` methods.

Attention:

Widget fields properties are not validated during the creation or update of a dashboard. This allows users to modify **built-in widgets** and create **custom widgets**, but also introduces the risk of creating or updating widgets incorrectly. To ensure the successful creation or update of the *Map navigation tree* widget, please refer to the parameter behavior outlined in the tables below.

Parameters

The following parameters are supported for the *Map navigation tree* widget.

Parameter	type	name	value
<i>Refresh interval</i>	0	rf_rate	0 - No refresh; 10 - 10 seconds; 30 - 30 seconds; 60 - 1 minute; 120 - 2 minutes; 600 - 10 minutes; 900 - (default) 15 minutes.
<i>Show unavailable maps</i>	1	show_unavailable	0 - (default) Disabled; 1 - Enabled.

Parameter	type	name	value
Reference	1	reference	Any string value consisting of 5 characters (e.g., ABCDE or JBPNL). This value must be unique within the dashboard to which the widget belongs.
			Parameter behavior: - required

The following parameters are supported for configuring map navigation tree elements.

Parameter	type	name	value
Name	1	navtree.1.name	Any string value.
Linked map	8	navtree.1.sysmapid	Note: The number in the property name sets the element number. Map ID.
Parameters for creating element hierarchy	0	navtree.1.parent	Note: The number in the property name references the element to which the map is linked. Parent element number.
	0	navtree.1.order	Note: The number in the property name references the child element. The property value references the parent element. Element position in the map navigation tree.
			Note: The number in the property name references the element number. The property value references the element position in the map navigation tree. Parent element position is determined within the whole map navigation tree. Child element position is determined within the parent element.

Examples

The following examples aim to only describe the configuration of the dashboard widget field objects for the *Map navigation tree* widget. For more information on configuring a dashboard, see [dashboard.create](#).

Configuring a *Map navigation tree* widget

Configure a *Map navigation tree* widget that displays the following map navigation tree:

- Element A
 - Element A1
 - Element A2
- Element B
 - Element B1 (contains linked map "1" that can be displayed in a *linked Map widget*)
 - Element B2
- Element C

Request:

```
{
  "jsonrpc": "2.0",
  "method": "dashboard.create",
  "params": {
    "name": "My dashboard",
    "display_period": 30,
    "auto_start": 1,
    "pages": [
      {
        "widgets": [
          {
            "type": "navtree",
            "name": "Map navigation tree",
            "x": 0,
            "y": 0,

```

```

"width": 18,
"height": 5,
"view_mode": 0,
"fields": [
  {
    "type": 1,
    "name": "navtree.1.name",
    "value": "Element A"
  },
  {
    "type": 1,
    "name": "navtree.2.name",
    "value": "Element B"
  },
  {
    "type": 1,
    "name": "navtree.3.name",
    "value": "Element C"
  },
  {
    "type": 1,
    "name": "navtree.4.name",
    "value": "Element A1"
  },
  {
    "type": 1,
    "name": "navtree.5.name",
    "value": "Element A2"
  },
  {
    "type": 1,
    "name": "navtree.6.name",
    "value": "Element B1"
  },
  {
    "type": 1,
    "name": "navtree.7.name",
    "value": "Element B2"
  },
  {
    "type": 0,
    "name": "navtree.4.parent",
    "value": 1
  },
  {
    "type": 0,
    "name": "navtree.5.parent",
    "value": 1
  },
  {
    "type": 0,
    "name": "navtree.6.parent",
    "value": 2
  },
  {
    "type": 0,
    "name": "navtree.7.parent",
    "value": 2
  },
  {
    "type": 0,
    "name": "navtree.1.order",

```

```

        "value": 1
    },
    {
        "type": 0,
        "name": "navtree.2.order",
        "value": 2
    },
    {
        "type": 0,
        "name": "navtree.3.order",
        "value": 3
    },
    {
        "type": 0,
        "name": "navtree.4.order",
        "value": 1
    },
    {
        "type": 0,
        "name": "navtree.5.order",
        "value": 2
    },
    {
        "type": 0,
        "name": "navtree.6.order",
        "value": 1
    },
    {
        "type": 0,
        "name": "navtree.7.order",
        "value": 2
    },
    {
        "type": 8,
        "name": "navtree.6.sysmapid",
        "value": 1
    },
    {
        "type": 1,
        "name": "reference",
        "value": "HJQXF"
    }
}
    ]
}
    ],
    "userGroups": [
        {
            "usrgrpId": 7,
            "permission": 2
        }
    ],
    "users": [
        {
            "userid": 1,
            "permission": 3
        }
    ]
},
    "id": 1
}

```

Response:

```
{
  "jsonrpc": "2.0",
  "result": {
    "dashboardids": [
      "3"
    ]
  },
  "id": 1
}
```

See also

- [Dashboard widget field](#)
- [dashboard.create](#)
- [dashboard.update](#)
- [Map](#)

20 Pie chart

Description

These parameters and the possible property values for the respective dashboard widget field objects allow to configure the *Pie chart* widget in `dashboard.create` and `dashboard.update` methods.

Attention:

Widget fields properties are not validated during the creation or update of a dashboard. This allows users to modify **built-in widgets** and create **custom widgets**, but also introduces the risk of creating or updating widgets incorrectly. To ensure the successful creation or update of the *Pie chart* widget, please refer to the parameter behavior outlined in the tables below.

Parameters

The following parameters are supported for the *Pie chart* widget.

Parameter	type	name	value
<i>Refresh interval</i>	0	rf_rate	0 - No refresh; 10 - 10 seconds; 30 - 30 seconds; 60 - (default) 1 minute; 120 - 2 minutes; 600 - 10 minutes; 900 - 15 minutes.

Data set

The following parameters are supported for configuring a *Data set*.

Note:

The first number in the property name (e.g. `ds.0.hosts.0`, `ds.0.items.0`) represents the particular data set, while the second number, if present, represents the configured host or item.

Parameter	type	name	value
<i>Data set type</i>	0	ds.0.dataset_type	0 - Item list; 1 - (default) Item patterns.

Parameter	type	name	value
<i>Items</i>	4	ds.0.itemids.0	<p>Item ID.</p> <p>When configuring the widget on a template dashboard, only items configured on the template should be set.</p> <p>Note: To configure multiple items, create a dashboard widget field object for each item with an incremented number in the property name.</p> <p>Parameter behavior:</p> <ul style="list-style-type: none"> - <i>required</i> if <i>Data set type</i> is set to "Item list" and <i>Items (Widget)</i> is not set
<i>Items (Widget)</i>	1	ds.0.itemids.0_reference	<p>Instead of Item ID: ABCDE. _itemid - set a compatible widget (with its <i>Reference</i> parameter set to "ABCDE") as the data source for items.</p> <p>Note: To configure multiple widgets, create a dashboard widget field object for each widget with an incremented number in the property name.</p> <p>Parameter behavior:</p> <ul style="list-style-type: none"> - <i>required</i> if <i>Data set type</i> is set to "Item list" and <i>Items</i> is not set
<i>Color</i>	1	ds.0.color.0	<p>Hexadecimal color code (e.g. FF0000).</p> <p>Parameter behavior:</p> <ul style="list-style-type: none"> - <i>supported</i> if <i>Data set type</i> is set to "Item list"
<i>Item type</i>	0	ds.0.type.0	<p>0 - (default) Normal; 1 - Total.</p> <p>The value "Total" can be set only for one item in the whole chart.</p> <p>Parameter behavior:</p> <ul style="list-style-type: none"> - <i>supported</i> if <i>Data set type</i> is set to "Item list"
<i>Host patterns</i>	1	ds.0.hosts.0	<p>Host name or pattern (e.g., "Zabbix*").</p> <p>Parameter behavior:</p> <ul style="list-style-type: none"> - <i>required</i> if <i>Data set type</i> is set to "Item patterns" <p>This parameter is not supported if configuring the widget on a template dashboard.</p>
<i>Item patterns</i>	1	ds.0.items.0	<p>Item name or pattern (e.g., "*: Number of processed *values per second").</p> <p>When configuring the widget on a template dashboard, only the patterns for items configured on the template should be set.</p> <p>Parameter behavior:</p> <ul style="list-style-type: none"> - <i>required</i> if <i>Data set type</i> is set to "Item patterns"
<i>Color</i>	1	ds.0.color	<p>Hexadecimal color code (e.g. FF0000).</p> <p>Parameter behavior:</p> <ul style="list-style-type: none"> - <i>supported</i> if <i>Data set type</i> is set to "Item patterns"
<i>Aggregation function</i>	0	ds.0.aggregate_function	<p>1 - min; 2 - max; 3 - avg; 4 - count; 5 - sum; 6 - first; 7 - (default) last.</p>

Parameter	type	name	value
Data set aggregation	0	ds.0.dataset_aggregation	(default) none; 1 - min; 2 - max; 3 - avg; 4 - count; 5 - sum. Parameter behavior: - supported if Item type is set to "Total"
Data set label	1	ds.0.data_set_label	Any string value. Default: "" (empty).

Displaying options

The following parameters are supported for configuring *Displaying options*.

Parameter	type	name	value
History data selection	0	source	0 - (default) Auto; 1 - History; 2 - Trends.
Draw	0	draw_type	0 - (default) Pie; 1 - Doughnut.
Width	0	width	20 - 20% of the radius; 30 - 30% of the radius; 40 - 40% of the radius; 50 - (default) 50% of the radius. Parameter behavior: - supported if Draw is set to "Doughnut"
Stroke width	0	stroke	Possible values range from 0-10. Default: 0.
Show total value	0	total_show	Parameter behavior: - supported if Draw is set to "Doughnut" 0 - (default) Disabled; 1 - Enabled.
Size	0	value_size_type	Parameter behavior: - supported if Draw is set to "Doughnut" 0 - (default) Auto; 1 - Custom.
Size (value for custom size)	0	value_size	Parameter behavior: - supported if Show total value is set to "Enabled" Possible values range from 1-100. Default: 20. Parameter behavior: - supported if Show total value is set to "Enabled"

Parameter	type	name	value
<i>Decimal places</i>	0	decimal_places	Possible values range from 0-6. Default: 2. Parameter behavior: - supported if <i>Show total value</i> is set to "Enabled"
<i>Units (checkbox)</i>	0	units_show	0 - (default) Disabled; 1 - Enabled. Parameter behavior: - supported if <i>Show total value</i> is set to "Enabled"
<i>Units (value)</i>	1	units	Any string value. Parameter behavior: - supported if <i>Units (checkbox)</i> is set to "Enabled"
<i>Bold</i>	0	value_bold	0 - (default) Disabled; 1 - Enabled. Parameter behavior: - supported if <i>Show total value</i> is set to "Enabled"
<i>Color</i>	1	value_color	Hexadecimal color code (e.g. FF0000). Parameter behavior: - supported if <i>Show total value</i> is set to "Enabled"
<i>Space between sectors</i>	0	space	Possible values range from 0-10. Default: 1.
<i>Merge sectors smaller than N% (checkbox)</i>	0	merge	0 - (default) Disabled; 1 - Enabled.
<i>Merge sectors smaller than N% (value)</i>	0	merge_percent	Possible values range from 1-10. Default: 1. Parameter behavior: - supported if <i>Merge sectors smaller than N% (checkbox)</i> is set to "Enabled"
<i>Merge sectors smaller than N% (color)</i>	1	merge_color	Hexadecimal color code (e.g. FF0000). Parameter behavior: - supported if <i>Merge sectors smaller than N% (checkbox)</i> is set to "Enabled"

Time period

The following parameters are supported for configuring *Time period*.

Parameter	type	name	value
<i>Time period</i>	1	time_period.reference	DASHBOARD._timeperiod - set the <i>Time period selector</i> as the data source; ABCDE._timeperiod - set a <i>compatible widget</i> (with its <i>Reference</i> parameter set to "ABCDE") as the data source. Default: DASHBOARD._timeperiod Alternatively, you can set the time period only in the <i>From</i> and <i>To</i> parameters.
<i>From</i>	1	time_period.from	Valid time string in absolute (YYYY-MM-DD hh:mm:ss) or <i>relative</i> time syntax (now, now/d, now/w-1w, etc.). Parameter behavior: - <i>supported</i> if <i>Time period</i> is not set
<i>To</i>	1	time_period.to	Valid time string in absolute (YYYY-MM-DD hh:mm:ss) or <i>relative</i> time syntax (now, now/d, now/w-1w, etc.). Parameter behavior: - <i>supported</i> if <i>Time period</i> is not set

Legend

The following parameters are supported for configuring *Legend*.

Parameter	type	name	value
<i>Show legend</i>	0	legend	0 - Disabled; 1 - (<i>default</i>) Enabled.
<i>Show value</i>	0	legend_value	0 - (<i>default</i>) Disabled; 1 - Enabled. Parameter behavior: - <i>supported</i> if <i>Show legend</i> is set to "Enabled"
<i>Show aggregation function</i>	0	legend_aggregation	0 - (<i>default</i>) Disabled; 1 - Enabled. Parameter behavior: - <i>supported</i> if <i>Show legend</i> is set to "Enabled"
<i>Rows</i>	0	legend_lines_mode	0 - (<i>default</i>) Fixed; 1 - Variable. Parameter behavior: - <i>supported</i> if <i>Show legend</i> is set to "Enabled"
<i>Number of rows/ Maximum number of rows</i>	0	legend_lines	Possible values range from 1-10. Default: 1. Parameter behavior: - <i>supported</i> if <i>Show legend</i> is set to "Enabled"
<i>Number of columns</i>	0	legend_columns	Possible values range from 1-4. Default: 4. Parameter behavior: - <i>supported</i> if <i>Show legend</i> is set to "Enabled", and <i>Show value</i> is set to "Disabled"

Examples

The following examples aim to only describe the configuration of the dashboard widget field objects for the *Pie chart* widget. For more information on configuring a dashboard, see [dashboard.create](#).

Configuring a *Pie chart* widget

Configure a *Pie chart* widget in the following way:

- 2 data sets for a total of 9 items on 1 host.
- The first data set is of type "Item list" and consists of 3 items that are all with type "Normal" and represented by a different color.
- The second data set is of type "Item patterns", consists of 6 items, has a configured aggregation for each item, and is represented by a custom color.
- The second data set also has a custom data set label.
- Data in the pie chart are displayed as a doughnut chart with a custom width and total value with units in the center.
- Data in the pie chart are displayed and aggregated for a custom time period of the last 3 hours.
- Pie chart legend displays configured items in 4 rows.

Request:

```
{
  "jsonrpc": "2.0",
  "method": "dashboard.create",
  "params": {
    "name": "My dashboard",
    "display_period": 30,
    "auto_start": 1,
    "pages": [
      {
        "widgets": [
          {
            "type": "piechart",
            "name": "Pie chart",
            "x": 0,
            "y": 0,
            "width": 24,
            "height": 5,
            "view_mode": 0,
            "fields": [
              {
                "type": 0,
                "name": "ds.0.dataset_type",
                "value": 0
              },
              {
                "type": 4,
                "name": "ds.0.itemids.1",
                "value": 23264
              },
              {
                "type": 1,
                "name": "ds.0.color.1",
                "value": "FF0000"
              },
              {
                "type": 0,
                "name": "ds.0.type.1",
                "value": 0
              },
              {
                "type": 4,
                "name": "ds.0.itemids.2",
                "value": 23269
              },
              {
                "type": 1,
                "name": "ds.0.color.2",
                "value": "BF00FF"
              }
            ]
          }
        ]
      }
    ]
  }
}
```

```

{
  "type": 0,
  "name": "ds.0.type.2",
  "value": 0
},
{
  "type": 4,
  "name": "ds.0.itemids.3",
  "value": 23257
},
{
  "type": 1,
  "name": "ds.0.color.3",
  "value": "0040FF"
},
{
  "type": 0,
  "name": "ds.0.type.3",
  "value": 0
},
{
  "type": 1,
  "name": "ds.1.hosts.0",
  "value": "Zabbix server"
},
{
  "type": 1,
  "name": "ds.1.items.0",
  "value": "*: Number of processed *values per second"
},
{
  "type": 1,
  "name": "ds.1.color",
  "value": "000000"
},
{
  "type": 0,
  "name": "ds.1.aggregate_function",
  "value": 3
},
{
  "type": 1,
  "name": "ds.1.data_set_label",
  "value": "Number of processed values per second"
},
{
  "type": 0,
  "name": "draw_type",
  "value": 1
},
{
  "type": 0,
  "name": "width",
  "value": 30
},
{
  "type": 0,
  "name": "total_show",
  "value": 1
},
{
  "type": 0,

```

```

        "name": "units_show",
        "value": 1
    },
    {
        "type": 0,
        "name": "graph_time",
        "value": 1
    },
    {
        "type": 1,
        "name": "time_period.from",
        "value": "now-3h"
    },
    {
        "type": 0,
        "name": "legend_lines",
        "value": 4
    }
    ]
}
],
"userGroups": [
    {
        "usrgrpid": 7,
        "permission": 2
    }
],
"users": [
    {
        "userid": 1,
        "permission": 3
    }
]
},
"id": 1
}

```

Response:

```

{
  "jsonrpc": "2.0",
  "result": {
    "dashboardids": [
      "3"
    ]
  },
  "id": 1
}

```

See also

- [Dashboard widget field](#)
- [dashboard.create](#)
- [dashboard.update](#)

21 Problem hosts

Description

These parameters and the possible property values for the respective dashboard widget field objects allow to configure the *Problem hosts* widget in `dashboard.create` and `dashboard.update` methods.

Attention:

Widget fields properties are not validated during the creation or update of a dashboard. This allows users to modify **built-in widgets** and create **custom widgets**, but also introduces the risk of creating or updating widgets incorrectly. To ensure the successful creation or update of the *Problem hosts* widget, please refer to the parameter behavior outlined in the tables below.

Parameters

The following parameters are supported for the *Problem hosts* widget.

Parameter	type	name	value
<i>Refresh interval</i>	0	rf_rate	0 - No refresh; 10 - 10 seconds; 30 - 30 seconds; 60 - (default) 1 minute; 120 - 2 minutes; 600 - 10 minutes; 900 - 15 minutes.
<i>Host groups</i>	2	groupids.0	Host group ID. Note: To configure multiple host groups, create a dashboard widget field object for each host group with an incremented number in the property name. This parameter is not supported if configuring the widget on a template dashboard .
<i>Host groups (Widget)</i>	1	groupids._reference	Instead of Host group ID : ABCDE._hostgroupids - set a compatible widget (with its <i>Reference</i> parameter set to "ABCDE") as the data source for host groups. This parameter is not supported if configuring the widget on a template dashboard .
<i>Exclude host groups</i>	2	exclude_groupids.0	Host group ID. Note: To exclude multiple host groups, create a dashboard widget field object for each host group with an incremented number in the property name. This parameter is not supported if configuring the widget on a template dashboard .
<i>Hosts</i>	3	hostids.0	Host ID. Note: To configure multiple hosts, create a dashboard widget field object for each host with an incremented number in the property name. For multiple hosts, the parameter <i>Host groups</i> must either be not configured at all or configured with at least one host group that the configured hosts belong to. This parameter is not supported if configuring the widget on a template dashboard .
<i>Hosts (Widget/Dashboard)</i>	1	hostids._reference	Instead of Host ID : DASHBOARD.hostids - set the Host selector as the data source for hosts; ABCDE._hostids - set a compatible widget (with its <i>Reference</i> parameter set to "ABCDE") as the data source for hosts. This parameter is not supported if configuring the widget on a template dashboard .
<i>Problem</i>	1	problem	Problem event name (case insensitive, full name or part of it).

Parameter	type	name	value
Severity	0	severities.0	0 - Not classified; 1 - Information; 2 - Warning; 3 - Average; 4 - High; 5 - Disaster. Default: empty (all enabled). Note: To configure multiple values, create a dashboard widget field object for each value with an incremented number in the property name.
<i>Problem tags</i>			
Evaluation type	0	evaltype	0 - (default) And/Or; 2 - Or.
Tag name	1	tags.0.tag	Any string value. Note: The number in the property name references tag order in the tag evaluation list.
Operator	0	tags.0.operator	Parameter behavior: - <i>required</i> if configuring <i>Problem tags</i> 0 - Contains; 1 - Equals; 2 - Does not contain; 3 - Does not equal; 4 - Exists; 5 - Does not exist. Note: The number in the property name references tag order in the tag evaluation list.
Tag value	1	tags.0.value	Parameter behavior: - <i>required</i> if configuring <i>Problem tags</i> Any string value. Note: The number in the property name references tag order in the tag evaluation list.
Show suppressed problems	0	show_suppressed	Parameter behavior: - <i>required</i> if configuring <i>Problem tags</i> 0 - (default) Disabled; 1 - Enabled.
Hide groups without problems	0	hide_empty_groups	0 - (default) Disabled; 1 - Enabled. This parameter is not supported if configuring the widget on a template dashboard .
Problem display	0	ext_ack	0 - (default) All; 1 - Unacknowledged only; 2 - Separated.

Parameter	type	name	value
<i>Reference</i>	1	reference	Any string value consisting of 5 characters (e.g., ABCDE or JBPNL). This value must be unique within the dashboard to which the widget belongs. Parameter behavior: - <i>required</i>

Examples

The following examples aim to only describe the configuration of the dashboard widget field objects for the *Problem hosts* widget. For more information on configuring a dashboard, see [dashboard.create](#).

Configuring a *Problem hosts* widget

Configure a *Problem hosts* widget that displays hosts from host groups "2" and "4" that have problems with a name that includes the string "CPU" and that have the following severities: "Warning", "Average", "High", "Disaster".

Request:

```
{
  "jsonrpc": "2.0",
  "method": "dashboard.create",
  "params": {
    "name": "My dashboard",
    "display_period": 30,
    "auto_start": 1,
    "pages": [
      {
        "widgets": [
          {
            "type": "problemhosts",
            "name": "Problem hosts",
            "x": 0,
            "y": 0,
            "width": 36,
            "height": 5,
            "view_mode": 0,
            "fields": [
              {
                "type": 2,
                "name": "groupids.0",
                "value": 2
              },
              {
                "type": 2,
                "name": "groupids.1",
                "value": 4
              },
              {
                "type": 1,
                "name": "problem",
                "value": "cpu"
              },
              {
                "type": 0,
                "name": "severities.0",
                "value": 2
              },
              {
                "type": 0,
                "name": "severities.1",
                "value": 3
              }
            ]
          }
        ]
      }
    ]
  }
}
```

```

        {
            "type": 0,
            "name": "severities.2",
            "value": 4
        },
        {
            "type": 0,
            "name": "severities.3",
            "value": 5
        }
    ]
}
],
"userGroups": [
    {
        "usrgrpId": 7,
        "permission": 2
    }
],
"users": [
    {
        "userId": 1,
        "permission": 3
    }
]
},
"id": 1
}

```

Response:

```

{
    "jsonrpc": "2.0",
    "result": {
        "dashboardids": [
            "3"
        ]
    },
    "id": 1
}

```

See also

- [Dashboard widget field](#)
- [dashboard.create](#)
- [dashboard.update](#)

22 Problems

Description

These parameters and the possible property values for the respective dashboard widget field objects allow to configure the *Problems* widget in `dashboard.create` and `dashboard.update` methods.

Attention:

Widget fields properties are not validated during the creation or update of a dashboard. This allows users to modify **built-in widgets** and create **custom widgets**, but also introduces the risk of creating or updating widgets incorrectly. To ensure the successful creation or update of the *Problems* widget, please refer to the parameter behavior outlined in the tables below.

Parameters

The following parameters are supported for the *Problems* widget.

Parameter	type	name	value
<i>Refresh interval</i>	0	rf_rate	0 - No refresh; 10 - 10 seconds; 30 - 30 seconds; 60 - (default) 1 minute; 120 - 2 minutes; 600 - 10 minutes; 900 - 15 minutes.
<i>Show</i>	0	show	1 - (default) Recent problems; 2 - History; 3 - Problems.
<i>Host groups</i>	2	groupids.0	Host group ID. Note: To configure multiple host groups, create a dashboard widget field object for each host group with an incremented number in the property name.
<i>Host groups (Widget)</i>	1	groupids._reference	This parameter is not supported if configuring the widget on a template dashboard . Instead of Host group ID : ABCDE._hostgroupids - set a compatible widget (with its <i>Reference</i> parameter set to "ABCDE") as the data source for host groups.
<i>Exclude host groups</i>	2	exclude_groupids.0	This parameter is not supported if configuring the widget on a template dashboard . Host group ID. Note: To exclude multiple host groups, create a dashboard widget field object for each host group with an incremented number in the property name.
<i>Hosts</i>	3	hostids.0	This parameter is not supported if configuring the widget on a template dashboard . Host ID. Note: To configure multiple hosts, create a dashboard widget field object for each host with an incremented number in the property name. For multiple hosts, the parameter <i>Host groups</i> must either be not configured at all or configured with at least one host group that the configured hosts belong to.
<i>Hosts (Widget/Dashboard)</i>	1	hostids._reference	This parameter is not supported if configuring the widget on a template dashboard . Instead of Host ID : DASHBOARD.hostids - set the Host selector as the data source for hosts; ABCDE._hostids - set a compatible widget (with its <i>Reference</i> parameter set to "ABCDE") as the data source for hosts.
<i>Problem</i>	1	problem	This parameter is not supported if configuring the widget on a template dashboard . Problem event name (case insensitive, full name or part of it).

Parameter	type	name	value
Severity	0	severities.0	0 - Not classified; 1 - Information; 2 - Warning; 3 - Average; 4 - High; 5 - Disaster. Default: empty (all enabled). Note: To configure multiple values, create a dashboard widget field object for each value with an incremented number in the property name.
<i>Problem tags</i>			
Evaluation type	0	evaltype	0 - (default) And/Or; 2 - Or.
Tag name	1	tags.0.tag	Any string value. Note: The number in the property name references tag order in the tag evaluation list.
Operator	0	tags.0.operator	Parameter behavior: - <i>required</i> if configuring <i>Problem tags</i> 0 - Contains; 1 - Equals; 2 - Does not contain; 3 - Does not equal; 4 - Exists; 5 - Does not exist. Note: The number in the property name references tag order in the tag evaluation list.
Tag value	1	tags.0.value	Parameter behavior: - <i>required</i> if configuring <i>Problem tags</i> Any string value. Note: The number in the property name references tag order in the tag evaluation list.
Show tags	0	show_tags	Parameter behavior: - <i>required</i> if configuring <i>Problem tags</i> 0 - (default) None; 1 - 1; 2 - 2; 3 - 3.
Tag name (format)	0	tag_name_format	0 - (default) Full; 1 - Shortened; 2 - None. Parameter behavior: - <i>supported</i> if <i>Show tags</i> is set to "1", "2", or "3"
Tag display priority	1	tag_priority	Comma-separated list of tags. Parameter behavior: - <i>supported</i> if <i>Show tags</i> is set to "1", "2", or "3"

Parameter	type	name	value
Show operational data	0	show_opdata	0 - (default) None; 1 - Separately; 2 - With problem name.
Show suppressed problems	0	show_suppressed	0 - (default) Disabled; 1 - Enabled.
Acknowledgement status	0	acknowledgement_status	0 - (default) all; 1 - Unacknowledged; 2 - Acknowledged.
By me	0	acknowledged_by_me	0 - (default) Disabled; 1 - Enabled.
Sort entries by	0	sort_triggers	1 - Severity (descending); 2 - Host (ascending); 3 - Time (ascending); 4 - (default) Time (descending); 13 - Severity (ascending); 14 - Host (descending); 15 - Problem (ascending); 16 - Problem (descending).
Show timeline	0	show_timeline	0 - Disabled; 1 - (default) Enabled. Parameter behavior: - supported if <i>Sort entries by</i> is set to "Time (descending)" or "Time (ascending)"
Show lines	0	show_lines	Possible values range from 1-100. Default: 25.
Reference	1	reference	Any string value consisting of 5 characters (e.g., ABCDE or JBPNL). This value must be unique within the dashboard to which the widget belongs. Parameter behavior: - required

Examples

The following examples aim to only describe the configuration of the dashboard widget field objects for the *Problems* widget. For more information on configuring a dashboard, see [dashboard.create](#).

Configuring a *Problems* widget

Configure a *Problems* widget that displays problems for host group "4" that satisfy the following conditions:

- Problems that have a tag with the name "scope" that contains values "performance" or "availability", or "capacity".
- Problems that have the following severities: "Warning", "Average", "High", "Disaster".

In addition, configure the widget to show tags and operational data.

Request:

```
{
  "jsonrpc": "2.0",
```

```

"method": "dashboard.create",
"params": {
  "name": "My dashboard",
  "display_period": 30,
  "auto_start": 1,
  "pages": [
    {
      "widgets": [
        {
          "type": "problems",
          "name": "Problems",
          "x": 0,
          "y": 0,
          "width": 36,
          "height": 5,
          "view_mode": 0,
          "fields": [
            {
              "type": 2,
              "name": "groupids.0",
              "value": 4
            },
            {
              "type": 1,
              "name": "tags.0.tag",
              "value": "scope"
            },
            {
              "type": 0,
              "name": "tags.0.operator",
              "value": 0
            },
            {
              "type": 1,
              "name": "tags.0.value",
              "value": "performance"
            },
            {
              "type": 1,
              "name": "tags.1.tag",
              "value": "scope"
            },
            {
              "type": 0,
              "name": "tags.1.operator",
              "value": 0
            },
            {
              "type": 1,
              "name": "tags.1.value",
              "value": "availability"
            },
            {
              "type": 1,
              "name": "tags.2.tag",
              "value": "scope"
            },
            {
              "type": 0,
              "name": "tags.2.operator",
              "value": 0
            }
          ]
        }
      ]
    }
  ]
}

```

```

        {
            "type": 1,
            "name": "tags.2.value",
            "value": "capacity"
        },
        {
            "type": 0,
            "name": "severities.0",
            "value": 2
        },
        {
            "type": 0,
            "name": "severities.1",
            "value": 3
        },
        {
            "type": 0,
            "name": "severities.2",
            "value": 4
        },
        {
            "type": 0,
            "name": "severities.3",
            "value": 5
        },
        {
            "type": 0,
            "name": "show_tags",
            "value": 1
        },
        {
            "type": 0,
            "name": "show_opdata",
            "value": 1
        }
    ]
}
    ]
}
],
"userGroups": [
    {
        "usrgrpid": 7,
        "permission": 2
    }
],
"users": [
    {
        "userid": 1,
        "permission": 3
    }
]
},
"id": 1
}

```

Response:

```

{
    "jsonrpc": "2.0",
    "result": {
        "dashboardids": [
            "3"
        ]
    }
}

```

```

    ],
    },
    "id": 1
}

```

See also

- [Dashboard widget field](#)
- [dashboard.create](#)
- [dashboard.update](#)

23 Problems by severity

Description

These parameters and the possible property values for the respective dashboard widget field objects allow to configure the *Problems by severity* widget in `dashboard.create` and `dashboard.update` methods.

Attention:

Widget fields properties are not validated during the creation or update of a dashboard. This allows users to modify **built-in widgets** and create **custom widgets**, but also introduces the risk of creating or updating widgets incorrectly. To ensure the successful creation or update of the *Problems by severity* widget, please refer to the parameter behavior outlined in the tables below.

Parameters

The following parameters are supported for the *Problems by severity* widget.

Parameter	type	name	value
<i>Refresh interval</i>	0	rf_rate	0 - No refresh; 10 - 10 seconds; 30 - 30 seconds; 60 - (default) 1 minute; 120 - 2 minutes; 600 - 10 minutes; 900 - 15 minutes.
<i>Host groups</i>	2	groupids.0	Host group ID. Note: To configure multiple host groups, create a dashboard widget field object for each host group with an incremented number in the property name. This parameter is not supported if configuring the widget on a template dashboard .
<i>Host groups (Widget)</i>	1	groupids._reference	Instead of Host group ID : ABCDE._hostgroupids - set a compatible widget (with its <i>Reference</i> parameter set to "ABCDE") as the data source for host groups. This parameter is not supported if configuring the widget on a template dashboard .
<i>Exclude host groups</i>	2	exclude_groupids.0	Host group ID. Note: To exclude multiple host groups, create a dashboard widget field object for each host group with an incremented number in the property name. This parameter is not supported if configuring the widget on a template dashboard .

Parameter	type	name	value
<i>Hosts</i>	3	hostids.0	<p>Host ID.</p> <p>Note: To configure multiple hosts, create a dashboard widget field object for each host with an incremented number in the property name. For multiple hosts, the parameter <i>Host groups</i> must either be not configured at all or configured with at least one host group that the configured hosts belong to.</p> <p>This parameter is not supported if configuring the widget on a template dashboard.</p>
<i>Hosts (Widget/Dashboard)</i>	1	hostids._reference	<p>Instead of Host ID: DASHBOARD.hostids - set the Host selector as the data source for hosts; ABCDE._hostids - set a compatible widget (with its <i>Reference</i> parameter set to "ABCDE") as the data source for hosts.</p> <p>This parameter is not supported if configuring the widget on a template dashboard.</p>
<i>Problem Severity</i>	1 0	problem severities.0	<p>Problem event name (case insensitive, full name or part of it).</p> <p>0 - Not classified; 1 - Information; 2 - Warning; 3 - Average; 4 - High; 5 - Disaster.</p> <p>Default: empty (all enabled).</p> <p>Note: To configure multiple values, create a dashboard widget field object for each value with an incremented number in the property name.</p>
<i>Problem tags</i>			
<i>Evaluation type</i>	0	evaltype	<p>0 - (default) And/Or; 2 - Or.</p>
<i>Tag name</i>	1	tags.0.tag	<p>Any string value.</p> <p>Note: The number in the property name references tag order in the tag evaluation list.</p>
<i>Operator</i>	0	tags.0.operator	<p>Parameter behavior: - <i>required</i> if configuring <i>Problem tags</i></p> <p>0 - Contains; 1 - Equals; 2 - Does not contain; 3 - Does not equal; 4 - Exists; 5 - Does not exist.</p> <p>Note: The number in the property name references tag order in the tag evaluation list.</p>
<i>Tag value</i>	1	tags.0.value	<p>Parameter behavior: - <i>required</i> if configuring <i>Problem tags</i></p> <p>Any string value.</p> <p>Note: The number in the property name references tag order in the tag evaluation list.</p> <p>Parameter behavior: - <i>required</i> if configuring <i>Problem tags</i></p>

Parameter	type	name	value
Show	0	show_type	0 - (default) Host groups; 1 - Totals. This parameter is not supported if configuring the widget on a template dashboard , and by default is set to "Totals".
Layout	0	layout	0 - (default) Horizontal; 1 - Vertical. Parameter behavior: - supported if Show is set to "Totals"
Show operational data	0	show_opdata	0 - (default) None; 1 - Separately; 2 - With problem name.
Show suppressed problems	0	show_suppressed	0 - (default) Disabled; 1 - Enabled.
Hide groups without problems	0	hide_empty_groups	0 - (default) Disabled; 1 - Enabled. Parameter behavior: - supported if Show is set to "Host groups" This parameter is not supported if configuring the widget on a template dashboard .
Problem display	0	ext_ack	0 - (default) All; 1 - Unacknowledged only; 2 - Separated.
Show timeline	0	show_timeline	0 - Disabled; 1 - (default) Enabled.
Reference	1	reference	Any string value consisting of 5 characters (e.g., ABCDE or JBPNL). This value must be unique within the dashboard to which the widget belongs. Parameter behavior: - required

Examples

The following examples aim to only describe the configuration of the dashboard widget field objects for the *Problems by severity* widget. For more information on configuring a dashboard, see [dashboard.create](#).

Configuring a *Problems by severity* widget

Configure a *Problems by severity* widget that displays problem totals for all host groups.

Request:

```
{
  "jsonrpc": "2.0",
  "method": "dashboard.create",
  "params": {
    "name": "My dashboard",
    "display_period": 30,
    "auto_start": 1,
    "pages": [
      {
        "widgets": [
```

```

    {
      "type": "problemsbysv",
      "name": "Problems by severity",
      "x": 0,
      "y": 0,
      "width": 36,
      "height": 5,
      "view_mode": 0,
      "fields": [
        {
          "type": 0,
          "name": "show_type",
          "value": 1
        }
      ]
    }
  ],
  "userGroups": [
    {
      "usrgrpid": 7,
      "permission": 2
    }
  ],
  "users": [
    {
      "userid": 1,
      "permission": 3
    }
  ]
},
"id": 1
}

```

Response:

```

{
  "jsonrpc": "2.0",
  "result": {
    "dashboardids": [
      "3"
    ]
  },
  "id": 1
}

```

See also

- [Dashboard widget field](#)
- [dashboard.create](#)
- [dashboard.update](#)

24 SLA report

Description

These parameters and the possible property values for the respective dashboard widget field objects allow to configure the *SLA report* widget in `dashboard.create` and `dashboard.update` methods.

Attention:

Widget fields properties are not validated during the creation or update of a dashboard. This allows users to modify **built-in widgets** and create **custom widgets**, but also introduces the risk of creating or updating widgets incorrectly. To ensure the successful creation or update of the *SLA report* widget, please refer to the parameter behavior outlined in the tables below.

Parameters

The following parameters are supported for the *SLA report* widget.

Parameter	type	name	value
<i>Refresh interval</i>	0	rf_rate	0 - (default) No refresh; 10 - 10 seconds; 30 - 30 seconds; 60 - 1 minute; 120 - 2 minutes; 600 - 10 minutes; 900 - 15 minutes.
SLA	10	slaid.0	SLA ID. Parameter behavior: - <i>required</i>
<i>Service</i>	9	serviceid.0	Service ID.
<i>Show periods</i>	0	show_periods	Possible values range from 1-100.
<i>From</i>	1	date_from	Default: 20. Valid date string in format YYYY-MM-DD. Relative dates with modifiers d, w, M, y (e.g. now, now/d, now/w-1w, etc.) are supported.
<i>To</i>	1	date_to	Valid date string in format YYYY-MM-DD. Relative dates with modifiers d, w, M, y (e.g. now, now/d, now/w-1w, etc.) are supported.

Examples

The following examples aim to only describe the configuration of the dashboard widget field objects for the *SLA report* widget. For more information on configuring a dashboard, see [dashboard.create](#).

Configuring an *SLA report* widget

Configure an *SLA report* widget that displays the SLA report for SLA "4" service "2" for the period of last 30 days.

Request:

```
{
  "jsonrpc": "2.0",
  "method": "dashboard.create",
  "params": {
    "name": "My dashboard",
    "display_period": 30,
    "auto_start": 1,
    "pages": [
      {
        "widgets": [
          {
            "type": "slareport",
            "name": "SLA report",
            "x": 0,
            "y": 0,
            "width": 36,
            "height": 5,
            "view_mode": 0,
            "fields": [
              {
```

```

        "type": 10,
        "name": "slaid.0",
        "value": 4
    },
    {
        "type": 9,
        "name": "serviceid.0",
        "value": 2
    },
    {
        "type": 1,
        "name": "date_from",
        "value": "now-30d"
    },
    {
        "type": 1,
        "name": "date_to",
        "value": "now"
    }
    ]
}
]
}
],
"userGroups": [
    {
        "usrgrpid": 7,
        "permission": 2
    }
],
"users": [
    {
        "userid": 1,
        "permission": 3
    }
]
},
"id": 1
}

```

Response:

```

{
  "jsonrpc": "2.0",
  "result": {
    "dashboardids": [
      "3"
    ]
  },
  "id": 1
}

```

See also

- [Dashboard widget field](#)
- [dashboard.create](#)
- [dashboard.update](#)

25 System information

Description

These parameters and the possible property values for the respective dashboard widget field objects allow to configure the *System*

Information widget in `dashboard.create` and `dashboard.update` methods.

Attention:

Widget fields properties are not validated during the creation or update of a dashboard. This allows users to modify **built-in widgets** and create **custom widgets**, but also introduces the risk of creating or updating widgets incorrectly. To ensure the successful creation or update of the *System information* widget, please refer to the parameter behavior outlined in the tables below.

Parameters

The following parameters are supported for the *System Information* widget.

Parameter	type	name	value
<i>Refresh interval</i>	0	<code>rf_rate</code>	0 - No refresh; 10 - 10 seconds; 30 - 30 seconds; 60 - 1 minute; 120 - 2 minutes; 600 - 10 minutes; 900 - (default) 15 minutes.
<i>Show</i>	0	<code>info_type</code>	0 - (default) System stats; 1 - High availability nodes.
<i>Show software update check details</i>	0	<code>show_software_update_check_details</code>	0 - (default) Disabled; 1 - Enabled.

Parameter behavior:
- supported if `AllowSoftwareUpdateCheck` in Zabbix server configuration is enabled and *Show* is set to "System stats"

Examples

The following examples aim to only describe the configuration of the dashboard widget field objects for the *System information* widget. For more information on configuring a dashboard, see `dashboard.create`.

Configuring a *System information* widget

Configure a *System information* widget that displays system stats with a refresh interval of 10 minutes and software update check enabled.

Request:

```
{
  "jsonrpc": "2.0",
  "method": "dashboard.create",
  "params": {
    "name": "My dashboard",
    "display_period": 30,
    "auto_start": 1,
    "pages": [
      {
        "widgets": [
          {
            "type": "systeminfo",
            "name": "System information",
            "x": 0,
            "y": 0,
            "width": 36,
            "height": 5,
            "view_mode": 0,
            "fields": [
              {
                "type": 0,
                "name": "rf_rate",
                "value": 600
              }
            ]
          }
        ]
      }
    ]
  }
}
```

```

    },
    {
      "type": 0,
      "name": "show_software_update_check_details",
      "value": 1
    }
  ]
},
"userGroups": [
  {
    "usrgrpId": 7,
    "permission": 2
  }
],
"users": [
  {
    "userId": 1,
    "permission": 3
  }
]
},
"id": 1
}

```

Response:

```

{
  "jsonrpc": "2.0",
  "result": {
    "dashboardids": [
      "3"
    ]
  },
  "id": 1
}

```

See also

- [Dashboard widget field](#)
- [dashboard.create](#)
- [dashboard.update](#)

26 Top hosts

Description

These parameters and the possible property values for the respective dashboard widget field objects allow to configure the *Top hosts* widget in `dashboard.create` and `dashboard.update` methods.

Attention:

Widget fields properties are not validated during the creation or update of a dashboard. This allows users to modify **built-in widgets** and create **custom widgets**, but also introduces the risk of creating or updating widgets incorrectly. To ensure the successful creation or update of the *Top hosts* widget, please refer to the parameter behavior outlined in the tables below.

Parameters

The following parameters are supported for the *Top hosts* widget.

Parameter	type	name	value
<i>Refresh interval</i>	0	rf_rate	0 - No refresh; 10 - 10 seconds; 30 - 30 seconds; 60 - (default) 1 minute; 120 - 2 minutes; 600 - 10 minutes; 900 - 15 minutes.
<i>Host groups</i>	2	groupids.0	Host group ID. Note: To configure multiple host groups, create a dashboard widget field object for each host group with an incremented number in the property name. This parameter is not supported if configuring the widget on a template dashboard .
<i>Host groups (Widget)</i>	1	groupids._reference	Instead of Host group ID : ABCDE._hostgroupids - set a compatible widget (with its <i>Reference</i> parameter set to "ABCDE") as the data source for host groups. This parameter is not supported if configuring the widget on a template dashboard .
<i>Hosts</i>	3	hostids.0	Host ID. Note: To configure multiple hosts, create a dashboard widget field object for each host with an incremented number in the property name. For multiple hosts, the parameter <i>Host groups</i> must either be not configured at all or configured with at least one host group that the configured hosts belong to. This parameter is not supported if configuring the widget on a template dashboard .
<i>Hosts (Widget/Dashboard)</i>	1	hostids._reference	Instead of Host ID : DASHBOARD.hostids - set the Host selector as the data source for hosts; ABCDE._hostids - set a compatible widget (with its <i>Reference</i> parameter set to "ABCDE") as the data source for hosts. This parameter is not supported if configuring the widget on a template dashboard .
<i>Host tags Evaluation type</i>	0	evaltype	0 - (default) And/Or; 2 - Or. This parameter is not supported if configuring the widget on a template dashboard .
<i>Tag name</i>	1	tags.0.tag	Any string value. Note: The number in the property name references tag order in the tag evaluation list. Parameter behavior: - <i>required</i> if configuring <i>Host tags</i> This parameter is not supported if configuring the widget on a template dashboard .

Parameter	type	name	value
<i>Operator</i>	0	tags.0.operator	0 - Contains; 1 - Equals; 2 - Does not contain; 3 - Does not equal; 4 - Exists; 5 - Does not exist. Note: The number in the property name references tag order in the tag evaluation list. Parameter behavior: - <i>required</i> if configuring <i>Host tags</i> This parameter is not supported if configuring the widget on a template dashboard .
<i>Tag value</i>	1	tags.0.value	Any string value. Note: The number in the property name references tag order in the tag evaluation list. Parameter behavior: - <i>required</i> if configuring <i>Host tags</i> This parameter is not supported if configuring the widget on a template dashboard .
<i>Show hosts in maintenance Columns (see below)</i>	0	maintenance	0 - (default) Disabled; 1 - Enabled.
<i>Order by Order</i>	0	column	Column numeric value from the configured columns.
	0	order	2 - (default) Top N; 3 - Bottom N.
<i>Host limit</i>	0	show_lines	Possible values range from 1-1000. Default: 10. This parameter is not supported if configuring the widget on a template dashboard .

Columns

Columns have common parameters and additional parameters depending on the configuration of the parameter *Data*.

Note:

For all parameters related to columns the number in the property name (e.g. columns.0.name) references a column for which the parameter is configured.

The following parameters are supported for all columns.

Parameter	type	name	value
Name	1	columns.0.name	Any string value.
Data	0	columns.0.data	<p>Parameter behavior: - required</p> <p>1 - Item value; 2 - Host name; 3 - Text.</p> <p>Parameter behavior: - required</p>
Base color	1	columns.0.base_color	Hexadecimal color code (e.g. FF0000).
			Parameter behavior: - required

Item value

The following parameters are supported if *Data* is set to "Item value".

Note:

The first number in the *Thresholds* property name (e.g. columnsthresholds.0.color.0) references the column for which thresholds are configured, while the second number references threshold place in a list, sorted in ascending order. However, if thresholds are configured in a different order, the values will be sorted in ascending order after updating widget configuration in Zabbix frontend (e.g. "threshold.0.threshold": "5" → "threshold.0.threshold": "1"; "threshold.1.threshold": "1" → "threshold.1.threshold": "5").

Parameter	type	name	value
Item	1	columns.0.item	Valid item name.
Display item value as	0	columns.0.display_value	<p>When configuring the widget on a template dashboard, only items configured on the template should be set.</p> <p>(default) Numeric; 1 - Text; 2 - Binary.</p>
Display	0	columns.0.display	<p>1 - (default) As is; 2 - Bar; 3 - Indicators; 6 - Sparkline.</p> <p>Parameter behavior: - supported if <i>Display item value as</i> is set to "Numeric"</p>
Min	1	columns.0.min	Any numeric value.
Max	1	columns.0.max	Any numeric value.
Decimal places	0	columns.0.decimal_places	<p>Parameter behavior: - supported if <i>Display item value as</i> is set to "Numeric" and <i>Display</i> is set to "Bar" or "Indicators"</p> <p>Possible values range from 0-10.</p> <p>Default: 2.</p> <p>Parameter behavior: - supported if <i>Display item value as</i> is set to "Numeric"</p>
Sparkline			

Parameter	type	name	value
<i>Width</i>	0	columns.0.sparkline.Width	<p>Possible values range from 0-10.</p> <p>Default: 1.</p> <p>Parameter behavior:</p> <ul style="list-style-type: none"> - supported if <i>Display item value as</i> is set to "Numeric" and <i>Display</i> is set to "Sparkline"
<i>Fill</i>	0	columns.0.sparkline.Fill	<p>Possible values range from 0-10.</p> <p>Default: 3.</p> <p>Parameter behavior:</p> <ul style="list-style-type: none"> - supported if <i>Display item value as</i> is set to "Numeric" and <i>Display</i> is set to "Sparkline"
<i>Color</i>	1	columns.0.sparkline.Color	<p>Hexadecimal color code (e.g. FF0000).</p> <p>Default: 42A5F5.</p> <p>Parameter behavior:</p> <ul style="list-style-type: none"> - supported if <i>Display item value as</i> is set to "Numeric" and <i>Display</i> is set to "Sparkline"
<i>Time period</i>	1	columns.0.sparkline.DASHBOARD_ref.timeperiod	<p><i>DASHBOARD_ref.timeperiod</i> - set the Time period selector as the data source; <i>ABCDE._timeperiod</i> - set a compatible widget (with its reference parameter equal to <i>ABCDE</i>) as the data source.</p> <p>Default: <i>DASHBOARD._timeperiod</i></p> <p>Alternatively, you can set the time period only in the <i>From</i> and <i>To</i> parameters.</p> <p>Parameter behavior:</p> <ul style="list-style-type: none"> - supported if <i>Display item value as</i> is set to "Numeric" and <i>Display</i> is set to "Sparkline"
<i>From</i>	1	columns.0.sparkline.Valid_time_string	<p>Valid time string in absolute (YYYY-MM-DD hh:mm:ss) or relative time syntax (<i>now</i>, <i>now/d</i>, <i>now/w-1w</i>, etc.).</p> <p>Parameter behavior:</p> <ul style="list-style-type: none"> - supported if <i>Display item value as</i> is set to "Numeric" and <i>Display</i> is set to "Sparkline"
<i>To</i>	1	columns.0.sparkline.Valid_time_string	<p>Valid time string in absolute (YYYY-MM-DD hh:mm:ss) or relative time syntax (<i>now</i>, <i>now/d</i>, <i>now/w-1w</i>, etc.).</p> <p>Parameter behavior:</p> <ul style="list-style-type: none"> - supported if <i>Display item value as</i> is set to "Numeric" and <i>Display</i> is set to "Sparkline"
<i>History data</i>	0	columns.0.sparkline.History	<p>Default: Auto; 1 - History; 2 - Trends.</p> <p>Parameter behavior:</p> <ul style="list-style-type: none"> - supported if <i>Display item value as</i> is set to "Numeric" and <i>Display</i> is set to "Sparkline"
<i>Thresholds Color</i>	1	columnsthresholds.0.Hcolor	<p>Hexadecimal color code (e.g. FF0000).</p> <p>Parameter behavior:</p> <ul style="list-style-type: none"> - supported if <i>Display item value as</i> is set to "Numeric"
<i>Threshold</i>	1	columnsthresholds.0.Amplitude	<p>Amplitude value.</p> <p>Parameter behavior:</p> <ul style="list-style-type: none"> - supported if <i>Display item value as</i> is set to "Numeric"

Parameter	type	name	value
<i>Highlights</i>			
Color	1	columns.0.highlights. field	Hexadecimal color code (e.g. FF0000).
			<p>Parameter behavior:</p> <ul style="list-style-type: none"> - supported if <i>Display item value as is</i> is set to "Text"
Pattern	1	columns.0.highlights. displaying	Any string value.
			<p>Parameter behavior:</p> <ul style="list-style-type: none"> - supported if <i>Display item value as is</i> is set to "Text"
Show thumbnail	0	columns.0.show_thumbnail	0 - (default) Disabled; 1 - Enabled.
			<p>Parameter behavior:</p> <ul style="list-style-type: none"> - supported if <i>Display item value as is</i> is set to "Binary"
Aggregation function	0	columns.0.aggregate_function	0 - (default) not used; 1 - min; 2 - max; 3 - avg; 4 - count; 5 - sum; 6 - first; 7 - last.
Time period	1	columns.0.time_period	DASHBOARD._timeperiod - set the <i>Time period selector</i> as the data source; ABCDE._timeperiod - set a <i>compatible widget</i> (with its reference parameter equal to ABCDE) as the data source.
			<p>Default: DASHBOARD._timeperiod</p> <p>Alternatively, you can set the time period only in the <i>From</i> and <i>To</i> parameters.</p> <p>Parameter behavior:</p> <ul style="list-style-type: none"> - supported if <i>Aggregation function</i> is set to "min", "max", "avg", "count", "sum", "first", "last"
From	1	columns.0.time_period. from	Valid time string in absolute (YYYY-MM-DD hh:mm:ss) or <i>relative</i> time syntax (now, now/d, now/w-1w, etc.).
			<p>Parameter behavior:</p> <ul style="list-style-type: none"> - supported if <i>Time period</i> is not set and <i>Aggregation function</i> is set to "min", "max", "avg", "count", "sum", "first", "last"
To	1	columns.0.time_period. to	Valid time string in absolute (YYYY-MM-DD hh:mm:ss) or <i>relative</i> time syntax (now, now/d, now/w-1w, etc.).
			<p>Parameter behavior:</p> <ul style="list-style-type: none"> - supported if <i>Time period</i> is not set and <i>Aggregation function</i> is set to "min", "max", "avg", "count", "sum", "first", "last"
History data	0	columns.0.history	0 - (default) Auto; 1 - History; 2 - Trends.
			<p>Parameter behavior:</p> <ul style="list-style-type: none"> - supported if <i>Display item value as is</i> is set to "Numeric"
Reference	1	reference	Any string value consisting of 5 characters (e.g., ABCDE or JBPNL). This value must be unique within the dashboard to which the widget belongs.
			<p>Parameter behavior:</p> <ul style="list-style-type: none"> - required

The following parameters are supported if *Data* is set to "Text".

Parameter	type	name	value
Text	1	columns.0.text	Any string value, including macros. Supported macros: {HOST.*}, {INVENTORY.*}.

Parameter behavior:
- required if *Data* is set to "Text"

Examples

The following examples aim to only describe the configuration of the dashboard widget field objects for the *Top hosts* widget. For more information on configuring a dashboard, see [dashboard.create](#).

Configuring a *Top hosts* widget

Configure a *Top hosts* widget that displays top hosts by CPU utilization in host group "4". In addition, configure the following custom columns: "Host name", "CPU utilization in %", "1m avg", "5m avg", "15m avg", "Processes".

Request:

```
{
  "jsonrpc": "2.0",
  "method": "dashboard.create",
  "params": {
    "name": "My dashboard",
    "display_period": 30,
    "auto_start": 1,
    "pages": [
      {
        "widgets": [
          {
            "type": "tophosts",
            "name": "Top hosts",
            "x": 0,
            "y": 0,
            "width": 36,
            "height": 5,
            "view_mode": 0,
            "fields": [
              {
                "type": 2,
                "name": "groupids.0",
                "value": 4
              },
              {
                "type": 1,
                "name": "columns.0.name",
                "value": "Host"
              },
              {
                "type": 0,
                "name": "columns.0.data",
                "value": 2
              },
              {
                "type": 1,
                "name": "columns.0.base_color",
                "value": "FFFFFF"
              },
              {
                "type": 1,
                "name": "columns.1.name",
                "value": "CPU utilization in %"
              }
            ]
          }
        ]
      }
    ]
  }
}
```

```

},
{
  "type": 0,
  "name": "columns.1.data",
  "value": 1
},
{
  "type": 1,
  "name": "columns.1.base_color",
  "value": "4CAF50"
},
{
  "type": 1,
  "name": "columns.1.item",
  "value": "CPU utilization"
},
{
  "type": 0,
  "name": "columns.1.display",
  "value": 3
},
{
  "type": 1,
  "name": "columns.1.min",
  "value": "0"
},
{
  "type": 1,
  "name": "columns.1.max",
  "value": "100"
},
{
  "type": 1,
  "name": "columnsthresholds.1.color.0",
  "value": "FFFF00"
},
{
  "type": 1,
  "name": "columnsthresholds.1.threshold.0",
  "value": "50"
},
{
  "type": 1,
  "name": "columnsthresholds.1.color.1",
  "value": "FF8000"
},
{
  "type": 1,
  "name": "columnsthresholds.1.threshold.1",
  "value": "80"
},
{
  "type": 1,
  "name": "columnsthresholds.1.color.2",
  "value": "FF4000"
},
{
  "type": 1,
  "name": "columnsthresholds.1.threshold.2",
  "value": "90"
},
{

```

```

        "type": 1,
        "name": "columns.2.name",
        "value": "1m avg"
    },
    {
        "type": 0,
        "name": "columns.2.data",
        "value": 1
    },
    {
        "type": 1,
        "name": "columns.2.base_color",
        "value": "FFFFFF"
    },
    {
        "type": 1,
        "name": "columns.2.item",
        "value": "Load average (1m avg)"
    },
    {
        "type": 1,
        "name": "columns.3.name",
        "value": "5m avg"
    },
    {
        "type": 0,
        "name": "columns.3.data",
        "value": 1
    },
    {
        "type": 1,
        "name": "columns.3.base_color",
        "value": "FFFFFF"
    },
    {
        "type": 1,
        "name": "columns.3.item",
        "value": "Load average (5m avg)"
    },
    {
        "type": 1,
        "name": "columns.4.name",
        "value": "15m avg"
    },
    {
        "type": 0,
        "name": "columns.4.data",
        "value": 1
    },
    {
        "type": 1,
        "name": "columns.4.base_color",
        "value": "FFFFFF"
    },
    {
        "type": 1,
        "name": "columns.4.item",
        "value": "Load average (15m avg)"
    },
    {
        "type": 1,
        "name": "columns.5.name",

```

```

        "value": "Processes"
    },
    {
        "type": 0,
        "name": "columns.5.data",
        "value": 1
    },
    {
        "type": 1,
        "name": "columns.5.base_color",
        "value": "FFFFFF"
    },
    {
        "type": 1,
        "name": "columns.5.item",
        "value": "Number of processes"
    },
    {
        "type": 0,
        "name": "columns.5.decimal_places",
        "value": 0
    },
    {
        "type": 0,
        "name": "column",
        "value": 1
    }
    ]
}
],
"userGroups": [
    {
        "usrgrpid": 7,
        "permission": 2
    }
],
"users": [
    {
        "userid": 1,
        "permission": 3
    }
]
},
"id": 1
}

```

Response:

```

{
    "jsonrpc": "2.0",
    "result": {
        "dashboardids": [
            "3"
        ]
    },
    "id": 1
}

```

See also

- [Dashboard widget field](#)
- [dashboard.create](#)

- `dashboard.update`

27 Top items

Description

These parameters and the possible property values for the respective dashboard widget field objects allow to configure the *Top items* widget in `dashboard.create` and `dashboard.update` methods.

Attention:

Widget fields properties are not validated during the creation or update of a dashboard. This allows users to modify **built-in widgets** and create **custom widgets**, but also introduces the risk of creating or updating widgets incorrectly. To ensure the successful creation or update of the *Top items* widget, please refer to the parameter behavior outlined in the tables below.

Parameters

The following parameters are supported for the *Top items* widget.

Parameter	type	name	value
<i>Refresh interval</i>	0	<code>rf_rate</code>	0 - No refresh; 10 - 10 seconds; 30 - 30 seconds; 60 - (default) 1 minute; 120 - 2 minutes; 600 - 10 minutes; 900 - 15 minutes.
<i>Host groups</i>	2	<code>groupids.0</code>	Host group ID. Note: To configure multiple host groups, create a dashboard widget field object for each host group with an incremented number in the property name. This parameter is not supported if configuring the widget on a template dashboard .
<i>Host groups (Widget)</i>	1	<code>groupids._reference</code>	Instead of Host group ID : <code>ABCDE._hostgroupids</code> - set a compatible widget (with its <i>Reference</i> parameter set to "ABCDE") as the data source for host groups. This parameter is not supported if configuring the widget on a template dashboard .
<i>Hosts</i>	3	<code>hostids.0</code>	Host ID. Note: To configure multiple hosts, create a dashboard widget field object for each host with an incremented number in the property name. For multiple hosts, the parameter <i>Host groups</i> must either be not configured at all or configured with at least one host group that the configured hosts belong to. This parameter is not supported if configuring the widget on a template dashboard .
<i>Hosts (Widget/Dashboard)</i>	1	<code>hostids._reference</code>	Instead of Host ID : <code>DASHBOARD.hostids</code> - set the Host selector as the data source for hosts; <code>ABCDE._hostids</code> - set a compatible widget (with its <i>Reference</i> parameter set to "ABCDE") as the data source for hosts. This parameter is not supported if configuring the widget on a template dashboard .
<i>Host tags</i>			

Parameter	type	name	value
<i>Evaluation type</i>	0	host_tags_evaltype	0 - (default) And/Or; 2 - Or. This parameter is not supported if configuring the widget on a template dashboard .
<i>Tag name</i>	1	host_tags.0.tag	Any string value. Note: The number in the property name references tag order in the tag evaluation list. Parameter behavior: - <i>required</i> if configuring <i>Host tags</i> This parameter is not supported if configuring the widget on a template dashboard .
<i>Operator</i>	0	host_tags.0.operator	0 - Contains; 1 - Equals; 2 - Does not contain; 3 - Does not equal; 4 - Exists; 5 - Does not exist. Note: The number in the property name references tag order in the tag evaluation list. Parameter behavior: - <i>required</i> if configuring <i>Host tags</i> This parameter is not supported if configuring the widget on a template dashboard .
<i>Tag value</i>	1	host_tags.0.value	Any string value. Note: The number in the property name references tag order in the tag evaluation list. Parameter behavior: - <i>required</i> if configuring <i>Host tags</i> This parameter is not supported if configuring the widget on a template dashboard .
<i>Layout</i>	0	layout	0 - (default) Horizontal; 1 - Vertical.
<i>Show problems Items</i> (see below)	0	show_problems	0 - All; 1 - (default) Unsuppressed; 2 - None.

Advanced configuration

The following advanced configuration parameters are supported for the *Top items* widget.

Parameter	type	name	value
Host ordering			

Parameter	type	name	value
<i>Order by</i>	0	host_ordering_order_by	By (default) Host name; 3 - Item value.
<i>Item patterns</i>	1	host_ordering_item.0	Item name or pattern (e.g., "*": Number of processed *values per second").
			Note: To configure multiple item patterns, create a dashboard widget field object for each item pattern with an incremented number in the property name.
			When configuring the widget on a template dashboard , only the patterns for items configured on the template should be set.
			Parameter behavior: - required if <i>Order by</i> is set to "Item value"
<i>Order</i>	0	host_ordering_order	2 - (default) Top N; 3 - Bottom N.
<i>Limit</i>	0	host_ordering_limit	Possible values range from 1-100.
			Default: 10.
Item ordering			
<i>Order by</i>	0	item_ordering_order_by	Host; 2 - Item name; 3 - (default) Item value.
<i>Host patterns</i>	1	item_ordering_host.0	Host name or pattern.
			Note: To configure multiple host patterns, create a dashboard widget field object for each host pattern with an incremented number in the property name.
			Parameter behavior: - required if <i>Order by</i> is set to "Host"
<i>Order</i>	0	item_ordering_order	2 - (default) Top N; 3 - Bottom N.
<i>Limit</i>	0	item_ordering_limit	Possible values range from 1-100.
			Default: 10.

Columns

Note:

The first number in the property name (e.g. columns.0.items.0, columns.0.item_tags_evaltype) represents the particular column, while the second number, if present, represents the configured entity (e.g. item pattern, tag).

Parameter	type	name	value
<i>Item patterns</i>	1	columns.0.items.0	Item name or pattern (e.g., "*": Number of processed *values per second").
			Note: To configure multiple item patterns, create a dashboard widget field object for each item pattern with an incremented second number in the property name.
			When configuring the widget on a template dashboard , only the patterns for items configured on the template should be set.
			Parameter behavior: - required

Parameter	type	name	value
<i>Item tags</i>			
<i>Evaluation type</i>	0	columns.0.item_tags_evaluation_type	(default) And/Or; 2 - Or.
<i>Tag name</i>	1	columns.0.item_tags_order	Any string value. Note: The second number in the property name references tag order in the tag evaluation list.
<i>Operator</i>	0	columns.0.item_tags_operator	0 - Contains; 1 - Equals; 2 - Does not contain; 3 - Does not equal; 4 - Exists; 5 - Does not exist. Note: The second number in the property name references tag order in the tag evaluation list.
<i>Tag value</i>	1	columns.0.item_tags_value	Any string value. Note: The second number in the property name references tag order in the tag evaluation list.
<i>Base color</i>	1	columns.0.base_color	Hexadecimal color code (e.g. FF0000).
<i>Display value as</i>	0	columns.0.display_value_as	(default) Numeric; 2 - Text.
<i>Display</i>	0	columns.0.display	1 - (default) As is; 2 - Bar; 3 - Indicators; 6 - Sparkline.
<i>Min</i>	1	columns.0.min	Any numeric value. Suffixes (e.g. "1d", "2w", "4K", "8G") are supported. Parameter behavior: - supported if <i>Display value as</i> is set to "Numeric" and <i>Display</i> is set to "Bar" or "Indicators"
<i>Max</i>	1	columns.0.max	Any numeric value. Suffixes (e.g. "1d", "2w", "4K", "8G") are supported. Parameter behavior: - supported if <i>Display value as</i> is set to "Numeric" and <i>Display</i> is set to "Bar" or "Indicators"
<i>Sparkline Width</i>	0	columns.0.sparkline_width	Possible values range from 0-10. Default: 1. Parameter behavior: - supported if <i>Display</i> is set to "Sparkline"

Parameter	type	name	value
<i>Fill</i>	0	columns.0.sparkline.fill	<p>Possible values range from 0-10.</p> <p>Default: 3.</p> <p>Parameter behavior:</p> <ul style="list-style-type: none"> - <i>supported</i> if <i>Display</i> is set to "Sparkline"
<i>Color</i>	1	columns.0.sparkline.color	<p>Hexadecimal color code (e.g. FF0000).</p> <p>Default: 42A5F5.</p> <p>Parameter behavior:</p> <ul style="list-style-type: none"> - <i>supported</i> if <i>Display</i> is set to "Sparkline"
<i>Time period</i>	1	columns.0.sparkline.DASHBOARD_ref.timeperiod	<p>DASHBOARD_ref.timeperiod - set the <i>Time period selector</i> as the data source;</p> <p>ABCDE._timeperiod - set a compatible widget (with its reference parameter equal to ABCDE) as the data source.</p> <p>Default: DASHBOARD._timeperiod</p> <p>Alternatively, you can set the time period only in the <i>From</i> and <i>To</i> parameters.</p> <p>Parameter behavior:</p> <ul style="list-style-type: none"> - <i>supported</i> if <i>Display</i> is set to "Sparkline"
<i>From</i>	1	columns.0.sparkline.valid_timestring.from	<p>Valid time string in absolute (YYYY-MM-DD hh:mm:ss) or relative time syntax (now, now/d, now/w-1w, etc.).</p> <p>Parameter behavior:</p> <ul style="list-style-type: none"> - <i>supported</i> if <i>Display</i> is set to "Sparkline"
<i>To</i>	1	columns.0.sparkline.valid_timestring.to	<p>Valid time string in absolute (YYYY-MM-DD hh:mm:ss) or relative time syntax (now, now/d, now/w-1w, etc.).</p> <p>Parameter behavior:</p> <ul style="list-style-type: none"> - <i>supported</i> if <i>Display</i> is set to "Sparkline"
<i>History data</i>	0	columns.0.sparkline.history	<p>0 - (default) Auto;</p> <p>1 - History;</p> <p>2 - Trends.</p> <p>Parameter behavior:</p> <ul style="list-style-type: none"> - <i>supported</i> if <i>Display</i> is set to "Sparkline"
<i>Thresholds</i>			
<i>Color</i>	1	columns.0.thresholds.color	<p>Hexadecimal color code (e.g. FF0000).</p> <p>Parameter behavior:</p> <ul style="list-style-type: none"> - <i>supported</i> if <i>Display value as</i> is set to "Numeric"
<i>Threshold</i>	1	columns.0.thresholds.threshold	<p>Any numeric value. Suffixes (e.g. "1d", "2w", "4K", "8G") are supported.</p> <p>Parameter behavior:</p> <ul style="list-style-type: none"> - <i>supported</i> if <i>Display value as</i> is set to "Numeric"
<i>Highlights</i>			
<i>Highlight</i>	1	columns.0.highlights.color	<p>Hexadecimal color code (e.g. FF0000).</p> <p>Parameter behavior:</p> <ul style="list-style-type: none"> - <i>supported</i> if <i>Display value as</i> is set to "Text"
<i>Threshold</i>	1	columns.0.highlights.threshold	<p>Any regular expression.</p> <p>Parameter behavior:</p> <ul style="list-style-type: none"> - <i>supported</i> if <i>Display value as</i> is set to "Text"
<i>Decimal places</i>	0	columns.0.decimal_places	<p>Possible values range from 0-10.</p> <p>Default: 2.</p>

Parameter	type	name	value
Advanced configuration			
Aggregation function	0	columns.0.aggregation_function	<p>If <i>Display value as</i> is set to "Numeric":</p> <p>0 - (default) not used; 1 - min; 2 - max; 3 - avg; 4 - count; 5 - sum; 6 - first; 7 - last.</p> <p>If <i>Display value as</i> is set to "Text":</p> <p>0 - (default) not used; 4 - count; 6 - first; 7 - last.</p>
Time period	1	columns.0.time_period_selector	<p>DASHBOARD._timeperiod - set the <i>Time period selector</i> as the data source; ABCDE._timeperiod - set a <i>compatible widget</i> (with its reference parameter equal to ABCDE) as the data source.</p> <p>Default: DASHBOARD._timeperiod</p> <p>Alternatively, you can set the time period only in the <i>From</i> and <i>To</i> parameters.</p> <p>Parameter behavior:</p> <p>- <i>supported</i> if <i>Aggregation function</i> is set to "min", "max", "avg", "count", "sum", "first", "last"</p>
From	1	columns.0.time_period_from	<p>Valid time string in absolute (YYYY-MM-DD hh:mm:ss) or <i>relative</i> time syntax (now, now/d, now/w-1w, etc.).</p> <p>Parameter behavior:</p> <p>- <i>supported</i> if <i>Time period</i> is not set and <i>Aggregation function</i> is set to "min", "max", "avg", "count", "sum", "first", "last"</p>
To	1	columns.0.time_period_to	<p>Valid time string in absolute (YYYY-MM-DD hh:mm:ss) or <i>relative</i> time syntax (now, now/d, now/w-1w, etc.).</p> <p>Parameter behavior:</p> <p>- <i>supported</i> if <i>Time period</i> is not set and <i>Aggregation function</i> is set to "min", "max", "avg", "count", "sum", "first", "last"</p>
History data	0	columns.0.history	<p>0 - (default) Auto; 1 - History; 2 - Trends.</p> <p>Parameter behavior:</p> <p>- <i>supported</i> if <i>Display value as</i> is set to "Numeric"</p>

Examples

The following examples aim to only describe the configuration of the dashboard widget field objects for the *Top items* widget. For more information on configuring a dashboard, see [dashboard.create](#).

Configuring a *Top items* widget

Configure a *Top items* widget that displays data for host "10084" and only for items for which the tag with the name "component" contains the value "cpu". In addition, display the data with hosts located at the top and use a colored gauge bar for cell

representation.

Request:

```
{
  "jsonrpc": "2.0",
  "method": "dashboard.create",
  "params": {
    "name": "My dashboard",
    "display_period": 30,
    "auto_start": 1,
    "pages": [
      {
        "widgets": [
          {
            "type": "topitems",
            "name": "Top items",
            "x": 0,
            "y": 0,
            "width": 36,
            "height": 5,
            "view_mode": 0,
            "fields": [
              {
                "type": 3,
                "name": "hostids.0",
                "value": 10084
              },
              {
                "type": 1,
                "name": "columns.0.items.0",
                "value": "*"
              },
              {
                "type": 1,
                "name": "columns.0.item_tags.0.tag",
                "value": "component"
              },
              {
                "type": 0,
                "name": "columns.0.item_tags.0.operator",
                "value": 0
              },
              {
                "type": 1,
                "name": "columns.0.item_tags.0.value",
                "value": "cpu"
              },
              {
                "type": 0,
                "name": "columns.0.display",
                "value": 2
              },
              {
                "type": 0,
                "name": "layout",
                "value": 1
              }
            ]
          }
        ]
      }
    ]
  },
  "userGroups": [
```

```

    {
      "usrgrpid": 7,
      "permission": 2
    }
  ],
  "users": [
    {
      "userid": 1,
      "permission": 3
    }
  ]
},
"id": 1
}

```

Response:

```

{
  "jsonrpc": "2.0",
  "result": {
    "dashboardids": [
      "3"
    ]
  },
  "id": 1
}

```

See also

- [Dashboard widget field](#)
- [dashboard.create](#)
- [dashboard.update](#)

28 Top triggers

Description

These parameters and the possible property values for the respective dashboard widget field objects allow to configure the *Top triggers* widget in `dashboard.create` and `dashboard.update` methods.

Attention:

Widget fields properties are not validated during the creation or update of a dashboard. This allows users to modify **built-in widgets** and create **custom widgets**, but also introduces the risk of creating or updating widgets incorrectly. To ensure the successful creation or update of the *Top triggers* widget, please refer to the parameter behavior outlined in the tables below.

Parameters

The following parameters are supported for the *Top triggers* widget.

Parameter	type	name	value
<i>Refresh interval</i>	0	rf_rate	0 - (default) No refresh; 10 - 10 seconds; 30 - 30 seconds; 60 - 1 minute; 120 - 2 minutes; 600 - 10 minutes; 900 - 15 minutes.

Parameter	type	name	value
<i>Host groups</i>	2	groupids.0	<p>Host group ID.</p> <p>Note: To configure multiple host groups, create a dashboard widget field object for each host group with an incremented number in the property name.</p> <p>This parameter is not supported if configuring the widget on a template dashboard.</p>
<i>Hosts</i>	3	hostids.0	<p>Host ID.</p> <p>Note: To configure multiple hosts, create a dashboard widget field object for each host with an incremented number in the property name. For multiple hosts, the parameter <i>Host groups</i> must either be not configured at all or configured with at least one host group that the configured hosts belong to.</p> <p>This parameter is not supported if configuring the widget on a template dashboard.</p>
<i>Problem Severity</i>	1 0	problem severities.0	<p>Problem event name (case insensitive, full name or part of it).</p> <p>Trigger severities.</p> <p>0 - Not classified; 1 - Information; 2 - Warning; 3 - Average; 4 - High; 5 - Disaster.</p> <p>Default: empty (all enabled).</p> <p>Note: To configure multiple values, create a dashboard widget field object for each value with an incremented number in the property name.</p>
<i>Problem tags</i>			
<i>Evaluation type</i>	0	evaltype	0 - (default) And/Or; 2 - Or.
<i>Tag name</i>	1	tags.0.tag	Any string value.
			<p>Note: The number in the property name references tag order in the tag evaluation list.</p> <p>Parameter behavior: - <i>required</i> if configuring <i>Problem tags</i></p>
<i>Operator</i>	0	tags.0.operator	<p>0 - Contains; 1 - Equals; 2 - Does not contain; 3 - Does not equal; 4 - Exists; 5 - Does not exist.</p> <p>Note: The number in the property name references tag order in the tag evaluation list.</p> <p>Parameter behavior: - <i>required</i> if configuring <i>Problem tags</i></p>

Parameter	type	name	value
<i>Tag value</i>	1	tags.0.value	Any string value. Note: The number in the property name references tag order in the tag evaluation list. Parameter behavior: - <i>required</i> if configuring <i>Problem tags</i>
<i>Time period</i>	1	time_period.reference	DASHBOARD._timeperiod - set the <i>Time period selector</i> as the data source; ABCDE._timeperiod - set a <i>compatible widget</i> (with its <i>Reference</i> parameter set to "ABCDE") as the data source. Default: DASHBOARD._timeperiod Alternatively, you can set the time period only in the <i>From</i> and <i>To</i> parameters.
<i>From</i>	1	time_period.from	Valid time string in absolute (YYYY-MM-DD hh:mm:ss) or <i>relative</i> time syntax (now, now/d, now/w-1w, etc.). Parameter behavior: - <i>supported</i> if <i>Time period</i> is not set
<i>To</i>	1	time_period.to	Valid time string in absolute (YYYY-MM-DD hh:mm:ss) or <i>relative</i> time syntax (now, now/d, now/w-1w, etc.). Parameter behavior: - <i>supported</i> if <i>Time period</i> is not set
<i>Trigger limit</i>	0	show_lines	Possible values range from 1-100. Default: 10.

Examples

The following examples aim to only describe the configuration of the dashboard widget field objects for the *Top triggers* widget. For more information on configuring a dashboard, see [dashboard.create](#).

Configuring a *Top triggers* widget

Configure a *Top triggers* widget that displays the top 5 triggers for host group "4" with the count of all problems for each trigger. The widget displays only triggers that have severities "Warning", "Average", "High", or "Disaster", and problems that have a tag with the name "scope" that contains values "performance" or "availability", or "capacity".

Request:

```
{
  "jsonrpc": "2.0",
  "method": "dashboard.create",
  "params": {
    "name": "My dashboard",
    "display_period": 30,
    "auto_start": 1,
    "pages": [
      {
        "widgets": [
          {
            "type": "toptriggers",
            "name": "Top triggers",
            "x": 0,
            "y": 0,
            "width": 36,
            "height": 5,
            "view_mode": 0,
            "fields": [
              {
```

```

        "type": 2,
        "name": "groupids.0",
        "value": 4
    },
    {
        "type": 0,
        "name": "severities.0",
        "value": 2
    },
    {
        "type": 0,
        "name": "severities.1",
        "value": 3
    },
    {
        "type": 0,
        "name": "severities.2",
        "value": 4
    },
    {
        "type": 0,
        "name": "severities.3",
        "value": 5
    },
    {
        "type": 1,
        "name": "tags.0.tag",
        "value": "scope"
    },
    {
        "type": 0,
        "name": "tags.0.operator",
        "value": 0
    },
    {
        "type": 1,
        "name": "tags.0.value",
        "value": "performance"
    },
    {
        "type": 1,
        "name": "tags.1.tag",
        "value": "scope"
    },
    {
        "type": 0,
        "name": "tags.1.operator",
        "value": 0
    },
    {
        "type": 1,
        "name": "tags.1.value",
        "value": "availability"
    },
    {
        "type": 1,
        "name": "tags.2.tag",
        "value": "scope"
    },
    {
        "type": 0,
        "name": "tags.2.operator",

```



```

        "value": 0
      },
      {
        "type": 1,
        "name": "tags.2.value",
        "value": "capacity"
      },
      {
        "type": 0,
        "name": "show_lines",
        "value": 5
      }
    ]
  },
  "userGroups": [
    {
      "usrgrpId": 7,
      "permission": 2
    }
  ],
  "users": [
    {
      "userId": 1,
      "permission": 3
    }
  ]
},
"id": 1
}

```

Response:

```

{
  "jsonrpc": "2.0",
  "result": {
    "dashboardids": [
      "3"
    ]
  },
  "id": 1
}

```

See also

- [Dashboard widget field](#)
- [dashboard.create](#)
- [dashboard.update](#)

29 Trigger overview

Description

These parameters and the possible property values for the respective dashboard widget field objects allow to configure the *Trigger overview* widget in `dashboard.create` and `dashboard.update` methods.

Attention:

Widget fields properties are not validated during the creation or update of a dashboard. This allows users to modify **built-in widgets** and create **custom widgets**, but also introduces the risk of creating or updating widgets incorrectly. To ensure the successful creation or update of the *Trigger overview* widget, please refer to the parameter behavior outlined in the tables below.

Parameters

The following parameters are supported for the *Trigger Overview* widget.

Parameter	type	name	value
<i>Refresh interval</i>	0	rf_rate	0 - No refresh; 10 - 10 seconds; 30 - 30 seconds; 60 - (default) 1 minute; 120 - 2 minutes; 600 - 10 minutes; 900 - 15 minutes.
<i>Show</i>	0	show	1 - (default) Recent problems; 2 - Any; 3 - Problems.
<i>Host groups</i>	2	groupids.0	Host group ID. Note: To configure multiple host groups, create a dashboard widget field object for each host group with an incremented number in the property name. This parameter is not supported if configuring the widget on a template dashboard .
<i>Host groups (Widget)</i>	1	groupids._reference	Instead of Host group ID : ABCDE._hostgroupids - set a compatible widget (with its <i>Reference</i> parameter set to "ABCDE") as the data source for host groups. This parameter is not supported if configuring the widget on a template dashboard .
<i>Hosts</i>	3	hostids.0	Host ID. Note: To configure multiple hosts, create a dashboard widget field object for each host with an incremented number in the property name. For multiple hosts, the parameter <i>Host groups</i> must either be not configured at all or configured with at least one host group that the configured hosts belong to. This parameter is not supported if configuring the widget on a template dashboard .
<i>Hosts (Widget/Dashboard)</i>	1	hostids._reference	Instead of Host ID : DASHBOARD.hostids - set the Host selector as the data source for hosts; ABCDE._hostids - set a compatible widget (with its <i>Reference</i> parameter set to "ABCDE") as the data source for hosts. This parameter is not supported if configuring the widget on a template dashboard .
<i>Problem tags</i>			
<i>Evaluation type</i>	0	evaltype	0 - (default) And/Or; 2 - Or.

Parameter	type	name	value
<i>Tag name</i>	1	tags.0.tag	Any string value. Note: The number in the property name references tag order in the tag evaluation list. Parameter behavior: - <i>required</i> if configuring <i>Problem tags</i>
<i>Operator</i>	0	tags.0.operator	0 - Contains; 1 - Equals; 2 - Does not contain; 3 - Does not equal; 4 - Exists; 5 - Does not exist. Note: The number in the property name references tag order in the tag evaluation list. Parameter behavior: - <i>required</i> if configuring <i>Problem tags</i>
<i>Tag value</i>	1	tags.0.value	Any string value. Note: The number in the property name references tag order in the tag evaluation list. Parameter behavior: - <i>required</i> if configuring <i>Problem tags</i>
<i>Show suppressed problems</i>	0	show_suppressed	0 - (default) Disabled; 1 - Enabled.
<i>Layout</i>	0	layout	0 - (default) Horizontal; 1 - Vertical.

Examples

The following examples aim to only describe the configuration of the dashboard widget field objects for the *Trigger overview* widget. For more information on configuring a dashboard, see [dashboard.create](#).

Configuring a *Trigger overview* widget

Configure a *Trigger overview* widget that displays trigger states for all host groups that have triggers with a tag that has the name "scope" and contains value "availability".

Request:

```
{
  "jsonrpc": "2.0",
  "method": "dashboard.create",
  "params": {
    "name": "My dashboard",
    "display_period": 30,
    "auto_start": 1,
    "pages": [
      {
        "widgets": [
          {
            "type": "trigover",
            "name": "Trigger overview",
            "x": 0,
            "y": 0,
            "width": 36,
            "height": 5,

```

```

        "view_mode": 0,
        "fields": [
            {
                "type": 1,
                "name": "tags.0.tag",
                "value": "scope"
            },
            {
                "type": 0,
                "name": "tags.0.operator",
                "value": 0
            },
            {
                "type": 1,
                "name": "tags.0.value",
                "value": "availability"
            }
        ]
    },
    ],
    "userGroups": [
        {
            "usrgrpid": 7,
            "permission": 2
        }
    ],
    "users": [
        {
            "userid": 1,
            "permission": 3
        }
    ]
},
"id": 1
}

```

Response:

```

{
  "jsonrpc": "2.0",
  "result": {
    "dashboardids": [
      "3"
    ]
  },
  "id": 1
}

```

See also

- [Dashboard widget field](#)
- [dashboard.create](#)
- [dashboard.update](#)

30 URL

Description

These parameters and the possible property values for the respective dashboard widget field objects allow to configure the [URL](#) widget in `dashboard.create` and `dashboard.update` methods.

Attention:

Widget fields properties are not validated during the creation or update of a dashboard. This allows users to modify **built-in widgets** and create **custom widgets**, but also introduces the risk of creating or updating widgets incorrectly. To ensure the successful creation or update of the *URL* widget, please refer to the parameter behavior outlined in the tables below.

Parameters

The following parameters are supported for the *URL* widget.

Parameter	type	name	value
<i>Refresh interval</i>	0	rf_rate	0 - (default) No refresh; 10 - 10 seconds; 30 - 30 seconds; 60 - 1 minute; 120 - 2 minutes; 600 - 10 minutes; 900 - 15 minutes.
<i>URL</i>	1	url	Valid URL string.
<i>Override host</i>	1	override_hostid_reference	<p>Parameter behavior: - <i>required</i></p> <p>ABCDE._hostid - set a compatible widget (with its <i>Reference</i> parameter set to "ABCDE") as the data source for hosts; DASHBOARD._hostid - set the dashboard Host selector as the data source for hosts.</p> <p>This parameter is not supported if configuring the widget on a template dashboard.</p>

Examples

The following examples aim to only describe the configuration of the dashboard widget field objects for the *URL* widget. For more information on configuring a dashboard, see **dashboard.create**.

Configuring a *URL* widget

Configure a *URL* widget that displays the home page of Zabbix manual.

Request:

```
{
  "jsonrpc": "2.0",
  "method": "dashboard.create",
  "params": {
    "name": "My dashboard",
    "display_period": 30,
    "auto_start": 1,
    "pages": [
      {
        "widgets": [
          {
            "type": "url",
            "name": "URL",
            "x": 0,
            "y": 0,
            "width": 36,
            "height": 5,
            "view_mode": 0,
            "fields": [
              {
                "type": 1,
                "name": "url",
                "value": "https://www.zabbix.com/documentation/7.4/en"
              }
            ]
          }
        ]
      }
    ]
  }
}
```

```

    ],
    "userGroups": [
      {
        "usrgrpId": 7,
        "permission": 2
      }
    ],
    "users": [
      {
        "userId": 1,
        "permission": 3
      }
    ]
  },
  "id": 1
}

```

Response:

```

{
  "jsonrpc": "2.0",
  "result": {
    "dashboardids": [
      "3"
    ]
  },
  "id": 1
}

```

See also

- [Dashboard widget field](#)
- [dashboard.create](#)
- [dashboard.update](#)

31 Web monitoring

Description

These parameters and the possible property values for the respective dashboard widget field objects allow to configure the *Web monitoring* widget in `dashboard.create` and `dashboard.update` methods.

Attention:

Widget fields properties are not validated during the creation or update of a dashboard. This allows users to modify **built-in widgets** and create **custom widgets**, but also introduces the risk of creating or updating widgets incorrectly. To ensure the successful creation or update of the *Web monitoring* widget, please refer to the parameter behavior outlined in the tables below.

Parameters

The following parameters are supported for the *Web monitoring* widget.

Parameter	type	name	value
<i>Refresh interval</i>	0	rf_rate	0 - No refresh; 10 - 10 seconds; 30 - 30 seconds; 60 - (default) 1 minute; 120 - 2 minutes; 600 - 10 minutes; 900 - 15 minutes.
<i>Host groups</i>	2	groupids.0	Host group ID. Note: To configure multiple host groups, create a dashboard widget field object for each host group with an incremented number in the property name. This parameter is not supported if configuring the widget on a template dashboard .
<i>Host groups (Widget)</i>	1	groupids._reference	Instead of Host group ID : ABCDE._hostgroupids - set a compatible widget (with its <i>Reference</i> parameter set to "ABCDE") as the data source for host groups. This parameter is not supported if configuring the widget on a template dashboard .
<i>Exclude host groups</i>	2	exclude_groupids.0	Host group ID. Note: To exclude multiple host groups, create a dashboard widget field object for each host group with an incremented number in the property name. This parameter is not supported if configuring the widget on a template dashboard .
<i>Hosts</i>	3	hostids.0	Host ID. Note: To configure multiple hosts, create a dashboard widget field object for each host with an incremented number in the property name. For multiple hosts, the parameter <i>Host groups</i> must either be not configured at all or configured with at least one host group that the configured hosts belong to. This parameter is not supported if configuring the widget on a template dashboard .
<i>Hosts (Widget/Dashboard)</i>	1	hostids._reference	Instead of Host ID : DASHBOARD.hostids - set the Host selector as the data source for hosts; ABCDE._hostids - set a compatible widget (with its <i>Reference</i> parameter set to "ABCDE") as the data source for hosts. This parameter is not supported if configuring the widget on a template dashboard .
<i>Scenario tags</i>			
<i>Evaluation type</i>	0	evaltype	0 - (default) And/Or; 2 - Or.
<i>Tag name</i>	1	tags.0.tag	Any string value. Note: The number in the property name references tag order in the tag evaluation list. Parameter behavior: - <i>required</i> if configuring <i>Scenario tags</i>

Parameter	type	name	value
<i>Operator</i>	0	tags.0.operator	0 - Contains; 1 - Equals; 2 - Does not contain; 3 - Does not equal; 4 - Exists; 5 - Does not exist. Note: The number in the property name references tag order in the tag evaluation list. Parameter behavior: - <i>required</i> if configuring <i>Scenario tags</i>
<i>Tag value</i>	1	tags.0.value	Any string value. Note: The number in the property name references tag order in the tag evaluation list. Parameter behavior: - <i>required</i> if configuring <i>Scenario tags</i>
<i>Show hosts in maintenance Reference</i>	0	maintenance	0 - Disabled; 1 - (<i>default</i>) Enabled.
	1	reference	Any string value consisting of 5 characters (e.g., ABCDE or JBPNL). This value must be unique within the dashboard to which the widget belongs. Parameter behavior: - <i>required</i>

Examples

The following examples aim to only describe the configuration of the dashboard widget field objects for the *Web monitoring* widget. For more information on configuring a dashboard, see [dashboard.create](#).

Configuring a *Web monitoring* widget

Configure a *Web monitoring* widget that displays a status summary of the active web monitoring scenarios for host group "4".

Request:

```
{
  "jsonrpc": "2.0",
  "method": "dashboard.create",
  "params": {
    "name": "My dashboard",
    "display_period": 30,
    "auto_start": 1,
    "pages": [
      {
        "widgets": [
          {
            "type": "web",
            "name": "Web monitoring",
            "x": 0,
            "y": 0,
            "width": 18,
            "height": 3,
            "view_mode": 0,
            "fields": [
              {
```



```

        "type": 2,
        "name": "groupids.0",
        "value": 4
      }
    ]
  },
  "userGroups": [
    {
      "usrgrpuid": 7,
      "permission": 2
    }
  ],
  "users": [
    {
      "userid": 1,
      "permission": 3
    }
  ]
},
"id": 1
}

```

Response:

```

{
  "jsonrpc": "2.0",
  "result": {
    "dashboardids": [
      "3"
    ]
  },
  "id": 1
}

```

See also

- [Dashboard widget field](#)
- [dashboard.create](#)
- [dashboard.update](#)

Discovered host

This class is designed to work with discovered hosts.

Object references:

- [Discovered host](#)

Available methods:

- [dhost.get](#) - retrieve discovered hosts

Discovered host object

The following objects are directly related to the dhost API.

Discovered host

Note:

Discovered host are created by the Zabbix server and cannot be modified via the API.

The discovered host object contains information about a host discovered by a network discovery rule. It has the following properties.

Property	Type	Description
dhostid	ID	ID of the discovered host.
druleid	ID	ID of the discovery rule that detected the host.
lastdown	timestamp	Time when the discovered host last went down.
lastup	timestamp	Time when the discovered host last went up.
status	integer	Whether the discovered host is up or down. A host is up if it has at least one active discovered service.
		Possible values: 0 - host up; 1 - host down.

dhost.get

Description

integer/array dhost.get(object parameters)

The method allows to retrieve discovered hosts according to the given parameters.

Note:

This method is available to users of any type. Permissions to call the method can be revoked in user role settings. See [User roles](#) for more information.

Parameters

(object) Parameters defining the desired output.

The method supports the following parameters.

Parameter	Type	Description
dhostids	ID/array	Return only discovered hosts with the given IDs.
druleids	ID/array	Return only discovered hosts that have been created by the given discovery rules.
dserviceids	ID/array	Return only discovered hosts that are running the given services.
selectDRules	query	Return a drules property with an array of the discovery rules that detected the host.
selectDServices	query	Return a dservices property with the discovered services running on the host.
limitSelects	integer	Supports count. Limits the number of records returned by subselects.
sortfield	string/array	Applies to the following subselects: selectDServices - results will be sorted by dserviceid . Sort the result by the given properties.
countOutput	boolean	Possible values: dhostid , druleid . These parameters being common for all get methods are described in detail in the reference commentary .
editable	boolean	
excludeSearch	boolean	
filter	object	
limit	integer	
output	query	
preservekeys	boolean	
search	object	
searchByAny	boolean	
searchWildcardsEnabled	boolean	
sortorder	string/array	
startSearch	boolean	

Return values

(integer/array) Returns either:

- an array of objects;
- the count of retrieved objects, if the `countOutput` parameter has been used.

Examples

Retrieve discovered hosts by discovery rule

Retrieve all hosts and the discovered services they are running that have been detected by discovery rule "4".

Request:

```
{
  "jsonrpc": "2.0",
  "method": "dhost.get",
  "params": {
    "output": "extend",
    "selectDServices": "extend",
    "druleids": "4"
  },
  "id": 1
}
```

Response:

```
{
  "jsonrpc": "2.0",
  "result": [
    {
      "dservices": [
        {
          "dserviceid": "1",
          "dhostid": "1",
          "type": "4",
          "key_": "",
          "value": "",
          "port": "80",
          "status": "0",
          "lastup": "1337697227",
          "lastdown": "0",
          "dcheckid": "5",
          "ip": "192.168.1.1",
          "dns": "station.company.lan"
        }
      ],
      "dhostid": "1",
      "druleid": "4",
      "status": "0",
      "lastup": "1337697227",
      "lastdown": "0"
    },
    {
      "dservices": [
        {
          "dserviceid": "2",
          "dhostid": "2",
          "type": "4",
          "key_": "",
          "value": "",
          "port": "80",
          "status": "0",
          "lastup": "1337697234",
          "lastdown": "0",
          "dcheckid": "5",

```

```

        "ip": "192.168.1.4",
        "dns": "john.company.lan"
    }
],
"dhostid": "2",
"druleid": "4",
"status": "0",
"lastup": "1337697234",
"lastdown": "0"
},
{
    "dservices": [
        {
            "dserviceid": "3",
            "dhostid": "3",
            "type": "4",
            "key_": "",
            "value": "",
            "port": "80",
            "status": "0",
            "lastup": "1337697234",
            "lastdown": "0",
            "dcheckid": "5",
            "ip": "192.168.1.26",
            "dns": "printer.company.lan"
        }
    ],
    "dhostid": "3",
    "druleid": "4",
    "status": "0",
    "lastup": "1337697234",
    "lastdown": "0"
},
{
    "dservices": [
        {
            "dserviceid": "4",
            "dhostid": "4",
            "type": "4",
            "key_": "",
            "value": "",
            "port": "80",
            "status": "0",
            "lastup": "1337697234",
            "lastdown": "0",
            "dcheckid": "5",
            "ip": "192.168.1.7",
            "dns": "mail.company.lan"
        }
    ],
    "dhostid": "4",
    "druleid": "4",
    "status": "0",
    "lastup": "1337697234",
    "lastdown": "0"
}
],
"id": 1
}

```

See also

- [Discovered service](#)

- [Discovery rule](#)

Source

CDHost::get() in *ui/include/classes/api/services/CDHost.php*.

Discovered service

This class is designed to work with discovered services.

Object references:

- [Discovered service](#)

Available methods:

- `dservice.get` - retrieve discovered services

Discovered service object

The following objects are directly related to the `dservice` API.

Discovered service

Note:

Discovered services are created by the Zabbix server and cannot be modified via the API.

The discovered service object contains information about a service discovered by a network discovery rule on a host. It has the following properties.

Property	Type	Description
<code>dserviceid</code>	ID	ID of the discovered service.
<code>dcheckid</code>	ID	ID of the discovery check used to detect the service.
<code>dhostid</code>	ID	ID of the discovered host running the service.
<code>dns</code>	string	DNS of the host running the service.
<code>ip</code>	string	IP address of the host running the service.
<code>lastdown</code>	timestamp	Time when the discovered service last went down.
<code>lastup</code>	timestamp	Time when the discovered service last went up.
<code>port</code>	integer	Service port number.
<code>status</code>	integer	Status of the service.
		Possible values: 0 - service up; 1 - service down.
<code>value</code>	string	Value returned by the service when performing a Zabbix agent, SNMPv1, SNMPv2 or SNMPv3 discovery check.

`dservice.get`

Description

`integer/array dservice.get(object parameters)`

The method allows to retrieve discovered services according to the given parameters.

Note:

This method is available to users of any type. Permissions to call the method can be revoked in user role settings. See [User roles](#) for more information.

Parameters

(object) Parameters defining the desired output.

The method supports the following parameters.

Parameter	Type	Description
dserviceids	ID/array	Return only discovered services with the given IDs.
dhostids	ID/array	Return only discovered services that belong to the given discovered hosts.
dcheckids	ID/array	Return only discovered services that have been detected by the given discovery checks.
druleids	ID/array	Return only discovered services that have been detected by the given discovery rules.
selectDRules	query	Return a drules property with an array of the discovery rules that detected the service.
selectDHosts	query	Return a dhosts property with an array the discovered hosts that the service belongs to.
selectHosts	query	Return a hosts property with the hosts with the same IP address and proxy as the service.
limitSelects	integer	Supports count. Limits the number of records returned by subselects.
sortfield	string/array	Applies to the following subselects: <code>selectHosts</code> - result will be sorted by <code>hostid</code> . Sort the result by the given properties.
countOutput	boolean	Possible values: <code>dserviceid</code> , <code>dhostid</code> , <code>ip</code> . These parameters being common for all <code>get</code> methods are described in detail in the reference commentary .
editable	boolean	
excludeSearch	boolean	
filter	object	
limit	integer	
output	query	
preservekeys	boolean	
search	object	
searchByAny	boolean	
searchWildcardsEnabled	boolean	
sortorder	string/array	
startSearch	boolean	

Return values

(integer/array) Returns either:

- an array of objects;
- the count of retrieved objects, if the `countOutput` parameter has been used.

Examples

Retrieve services discovered on a host

Retrieve all discovered services detected on discovered host "11".

Request:

```
{
  "jsonrpc": "2.0",
  "method": "dservice.get",
  "params": {
    "output": "extend",
    "dhostids": "11"
  },
  "id": 1
}
```

Response:

```
{
  "jsonrpc": "2.0",
```

```

"result": [
  {
    "dserviceid": "12",
    "dhostid": "11",
    "value": "",
    "port": "80",
    "status": "1",
    "lastup": "0",
    "lastdown": "1348650607",
    "dcheckid": "5",
    "ip": "192.168.1.134",
    "dns": "john.local"
  },
  {
    "dserviceid": "13",
    "dhostid": "11",
    "value": "",
    "port": "21",
    "status": "1",
    "lastup": "0",
    "lastdown": "1348650610",
    "dcheckid": "6",
    "ip": "192.168.1.134",
    "dns": "john.local"
  }
],
"id": 1
}

```

See also

- [Discovered host](#)
- [Discovery check](#)
- [Host](#)

Source

`CDService::get()` in `ui/include/classes/api/services/CDService.php`.

Discovery check

This class is designed to work with discovery checks.

Object references:

- [Discovery check](#)

Available methods:

- `dcheck.get` - retrieve discovery checks

Discovery check object

The following objects are directly related to the `dcheck` API.

Discovery check

The discovery check object defines a specific check performed by a network discovery rule. It has the following properties.

Property	Type	Description
<code>dcheckid</code>	ID	ID of the discovery check.
<code>druleid</code>	ID	ID of the discovery rule that the check belongs to.

Property	Type	Description
key_	string	Item key (if type is set to "Zabbix agent") or SNMP OID (if type is set to "SNMPv1 agent", "SNMPv2 agent", or "SNMPv3 agent"). Property behavior: - <i>required</i> if type is set to "Zabbix agent", "SNMPv1 agent", "SNMPv2 agent", or "SNMPv3 agent"
ports	string	One or several port ranges to check, separated by commas. Default: 0. Property behavior: - <i>supported</i> if type is set to "SSH" (0), "LDAP" (1), "SMTP" (2), "FTP" (3), "HTTP" (4), "POP" (5), "NNTP" (6), "IMAP" (7), "TCP" (8), "Zabbix agent" (9), "SNMPv1 agent" (10), "SNMPv2 agent" (11), "SNMPv3 agent" (13), "HTTPS" (14), or "Telnet" (15)
snmp_community	string	SNMP community. Property behavior: - <i>required</i> if type is set to "SNMPv1 agent" or "SNMPv2 agent"
snmpv3_authpassphrase	string	Authentication passphrase. Property behavior: - <i>supported</i> if type is set to "SNMPv3 agent" and snmpv3_securitylevel is set to "authNoPriv" or "authPriv"
snmpv3_authprotocol	integer	Authentication protocol. Possible values: 0 - (default) MD5; 1 - SHA1; 2 - SHA224; 3 - SHA256; 4 - SHA384; 5 - SHA512. Property behavior: - <i>supported</i> if type is set to "SNMPv3 agent" and snmpv3_securitylevel is set to "authNoPriv" or "authPriv"
snmpv3_contextname	string	SNMPv3 context name. Property behavior: - <i>supported</i> if type is set to "SNMPv3 agent"
snmpv3_privpassphrase	string	Privacy passphrase. Property behavior: - <i>supported</i> if type is set to "SNMPv3 agent" and snmpv3_securitylevel is set to "authPriv"
snmpv3_privprotocol	integer	Privacy protocol. Possible values: 0 - (default) DES; 1 - AES128; 2 - AES192; 3 - AES256; 4 - AES192C; 5 - AES256C. Property behavior: - <i>supported</i> if type is set to "SNMPv3 agent" and snmpv3_securitylevel is set to "authPriv"

Property	Type	Description
snmpv3_securitylevel	string	Security level. Possible values: 0 - noAuthNoPriv; 1 - authNoPriv; 2 - authPriv.
snmpv3_securityname	string	Property behavior: - <i>supported</i> if type is set to "SNMPv3 agent" Security name.
type	integer	Property behavior: - <i>supported</i> if type is set to "SNMPv3 agent" Type of check. Possible values: 0 - SSH; 1 - LDAP; 2 - SMTP; 3 - FTP; 4 - HTTP; 5 - POP; 6 - NNTP; 7 - IMAP; 8 - TCP; 9 - Zabbix agent; 10 - SNMPv1 agent; 11 - SNMPv2 agent; 12 - ICMP ping; 13 - SNMPv3 agent; 14 - HTTPS; 15 - Telnet.
uniq	integer	Property behavior: - <i>required</i> Whether to use this check as a device uniqueness criteria. Only a single unique check can be configured for a discovery rule. Possible values: 0 - (<i>default</i>) do not use this check as a uniqueness criteria; 1 - use this check as a uniqueness criteria.
host_source	integer	Property behavior: - <i>supported</i> if type is set to "Zabbix agent", "SNMPv1 agent", "SNMPv2 agent", or "SNMPv3 agent" Source for host name.
name_source	integer	Possible values: 1 - (<i>default</i>) DNS; 2 - IP; 3 - discovery value of this check. Source for visible name. Possible values: 0 - (<i>default</i>) not specified; 1 - DNS; 2 - IP; 3 - discovery value of this check.

Property	Type	Description
allow_redirect	integer	<p>Allow situation where the target being ICMP pinged responds from a different IP address.</p> <p>Possible values:</p> <p>0 - <i>(default)</i> treat redirected responses as if the target host is down (fail);</p> <p>1 - treat redirected responses as if the target host is up (success).</p> <p>Property behavior:</p> <p>- <i>supported</i> if type is set to "ICMP ping"</p>

dcheck.get

Description

integer/array dcheck.get(object parameters)

The method allows to retrieve discovery checks according to the given parameters.

Note:

This method is available to users of any type. Permissions to call the method can be revoked in user role settings. See [User roles](#) for more information.

Parameters

(object) Parameters defining the desired output.

The method supports the following parameters.

Parameter	Type	Description
dcheckids	ID/array	Return only discovery checks with the given IDs.
druleids	ID/array	Return only discovery checks that belong to the given discovery rules.
dserviceids	ID/array	Return only discovery checks that have detected the given discovered services.
sortfield	string/array	Sort the result by the given properties.
countOutput	boolean	<p>Possible values: dcheckid, druleid.</p> <p>These parameters being common for all get methods are described in detail in the reference commentary.</p>
editable	boolean	
excludeSearch	boolean	
filter	object	
limit	integer	
output	query	
preservekeys	boolean	
search	object	
searchByAny	boolean	
searchWildcardsEnabled	boolean	
sortorder	string/array	
startSearch	boolean	

Return values

(integer/array) Returns either:

- an array of objects;
- the count of retrieved objects, if the countOutput parameter has been used.

Examples

Retrieve discovery checks for a discovery rule

Retrieve all discovery checks used by discovery rule "6".

Request:

```
{
  "jsonrpc": "2.0",
  "method": "dcheck.get",
  "params": {
    "output": "extend",
    "dcheckids": "6"
  },
  "id": 1
}
```

Response:

```
{
  "jsonrpc": "2.0",
  "result": [
    {
      "dcheckid": "6",
      "druleid": "4",
      "type": "3",
      "key_": "",
      "snmp_community": "",
      "ports": "21",
      "snmpv3_securityname": "",
      "snmpv3_securitylevel": "0",
      "snmpv3_authpassphrase": "",
      "snmpv3_privpassphrase": "",
      "uniq": "0",
      "snmpv3_authprotocol": "0",
      "snmpv3_privprotocol": "0",
      "snmpv3_contextname": "",
      "host_source": "1",
      "name_source": "0",
      "allow_redirect": "0"
    }
  ],
  "id": 1
}
```

Source

CDCheck::get() in `ui/include/classes/api/services/CDCheck.php`.

Discovery rule

This class is designed to work with network discovery rules.

Note:

This API is meant to work with network discovery rules. For low-level discovery rules, see [LLD rule API](#).

Object references:

- [Discovery rule](#)

Available methods:

- `drule.create` - create new network discovery rules
- `drule.delete` - delete network discovery rules
- `drule.get` - retrieve network discovery rules
- `drule.update` - update network discovery rules

Discovery rule object

The following objects are directly related to the `drule` API.

Discovery rule

The discovery rule object defines a network discovery rule. It has the following properties.

Property	Type	Description
druleid	ID	ID of the discovery rule. Property behavior: - <i>read-only</i>
iprange	string	- <i>required</i> for update operations One or several IP ranges to check, separated by commas. Refer to the network discovery configuration section for more information on supported formats of IP ranges. Property behavior: - <i>required</i> for create operations
name	string	Name of the discovery rule. Property behavior: - <i>required</i> for create operations
delay	string	Execution interval of the discovery rule. Accepts seconds or time unit with suffix (e.g., 30s, 1m, 2h, 1d), or a user macro. Default: 1h.
proxyid	ID	ID of the proxy used for discovery.
status	integer	Whether the discovery rule is enabled. Possible values: 0 - (<i>default</i>) enabled; 1 - disabled.
concurrency_max	integer	Maximum number of concurrent checks per discovery rule. Possible values: 0 - (<i>default</i>) unlimited number of checks; 1 - one check; 2-999 - custom number of checks.
error	string	Error text if there have been any problems when executing the discovery rule. Property behavior: - <i>read-only</i>

drule.create

Description

object drule.create(object/array discoveryRules)

This method allows to create new discovery rules.

Note:

This method is only available to *Admin* and *Super admin* user types. Permissions to call the method can be revoked in user role settings. See [User roles](#) for more information.

Parameters

(object/array) Discovery rules to create.

Additionally to the [standard discovery rule properties](#), the method accepts the following parameters.

Parameter	Type	Description
dchecks	array	Discovery checks to create for the discovery rule.

Parameter behavior:
- required

Return values

(object) Returns an object containing the IDs of the created discovery rules under the `druleids` property. The order of the returned IDs matches the order of the passed discovery rules.

Examples

Create a discovery rule

Create a discovery rule to find machines running the Zabbix agent in the local network. The rule must use a single Zabbix agent check on port 10050.

Request:

```
{
  "jsonrpc": "2.0",
  "method": "drule.create",
  "params": {
    "name": "Zabbix agent discovery",
    "iprange": "192.168.1.1-255",
    "concurrency_max": "10",
    "dchecks": [
      {
        "type": "9",
        "key_": "system.uname",
        "ports": "10050",
        "uniq": "0"
      }
    ]
  },
  "id": 1
}
```

Response:

```
{
  "jsonrpc": "2.0",
  "result": {
    "druleids": [
      "6"
    ]
  },
  "id": 1
}
```

See also

- [Discovery check](#)

Source

`CDRule::create()` in `ui/include/classes/api/services/CDRule.php`.

drule.delete

Description

object `drule.delete(array discoveryRuleIds)`

This method allows to delete discovery rules.

Note:

This method is only available to *Admin* and *Super admin* user types. Permissions to call the method can be revoked in user role settings. See [User roles](#) for more information.

Parameters

(array) IDs of the discovery rules to delete.

Return values

(object) Returns an object containing the IDs of the deleted discovery rules under the `druleids` property.

Examples

Delete multiple discovery rules

Delete two discovery rules.

Request:

```
{
  "jsonrpc": "2.0",
  "method": "drule.delete",
  "params": [
    "4",
    "6"
  ],
  "id": 1
}
```

Response:

```
{
  "jsonrpc": "2.0",
  "result": {
    "druleids": [
      "4",
      "6"
    ]
  },
  "id": 1
}
```

Source

`CDRule::delete()` in `ui/include/classes/api/services/CDRule.php`.

drule.get**Description**

`integer/array drule.get(object parameters)`

The method allows to retrieve discovery rules according to the given parameters.

Note:

This method is available to users of any type. Permissions to call the method can be revoked in user role settings. See [User roles](#) for more information.

Parameters

(object) Parameters defining the desired output.

The method supports the following parameters.

Parameter	Type	Description
<code>dhostids</code>	ID/array	Return only discovery rules that created the given discovered hosts.
<code>druleids</code>	ID/array	Return only discovery rules with the given IDs.
<code>dserviceids</code>	ID/array	Return only discovery rules that created the given discovered services.

Parameter	Type	Description
selectDChecks	query	Return a dchecks property with the discovery checks used by the discovery rule.
selectDHosts	query	Supports count. Return a dhosts property with the discovered hosts created by the discovery rule.
limitSelects	integer	Supports count. Limits the number of records returned by subselects.
sortfield	string/array	Supports count. Applies to the following subselects: selectDChecks - results will be sorted by dcheckid; selectDHosts - results will be sorted by dhostsid. Sort the result by the given properties.
countOutput	boolean	Possible values: druleid, name. These parameters being common for all get methods are described in detail in the reference commentary .
editable	boolean	
excludeSearch	boolean	
filter	object	
limit	integer	
output	query	
preservekeys	boolean	
search	object	
searchByAny	boolean	
searchWildcardsEnabled	boolean	
sortorder	string/array	
startSearch	boolean	

Return values

(integer/array) Returns either:

- an array of objects;
- the count of retrieved objects, if the countOutput parameter has been used.

Examples

Retrieve all discovery rules

Retrieve all configured discovery rules and the discovery checks they use.

Request:

```
{
  "jsonrpc": "2.0",
  "method": "drule.get",
  "params": {
    "output": "extend",
    "selectDChecks": "extend"
  },
  "id": 1
}
```

Response:

```
{
  "jsonrpc": "2.0",
  "result": [
    {
      "druleid": "2",
      "proxyid": "0",
      "name": "Local network",
      "iprange": "192.168.3.1-255",
    }
  ]
}
```

```

"delay": "5s",
"status": "0",
"concurrency_max": "0",
"error": "",
"dchecks": [
  {
    "dcheckid": "7",
    "druleid": "2",
    "type": "3",
    "key_": "",
    "snmp_community": "",
    "ports": "21",
    "snmpv3_securityname": "",
    "snmpv3_securitylevel": "0",
    "snmpv3_authpassphrase": "",
    "snmpv3_privpassphrase": "",
    "uniq": "0",
    "snmpv3_authprotocol": "0",
    "snmpv3_privprotocol": "0",
    "snmpv3_contextname": "",
    "host_source": "1",
    "name_source": "0",
    "allow_redirect": "0"
  },
  {
    "dcheckid": "8",
    "druleid": "2",
    "type": "4",
    "key_": "",
    "snmp_community": "",
    "ports": "80",
    "snmpv3_securityname": "",
    "snmpv3_securitylevel": "0",
    "snmpv3_authpassphrase": "",
    "snmpv3_privpassphrase": "",
    "uniq": "0",
    "snmpv3_authprotocol": "0",
    "snmpv3_privprotocol": "0",
    "snmpv3_contextname": "",
    "host_source": "1",
    "name_source": "0",
    "allow_redirect": "0"
  }
]
},
{
  "druleid": "6",
  "proxyid": "0",
  "name": "Zabbix agent discovery",
  "iprange": "192.168.1.1-255",
  "delay": "1h",
  "status": "0",
  "concurrency_max": "10",
  "error": "",
  "dchecks": [
    {
      "dcheckid": "10",
      "druleid": "6",
      "type": "9",
      "key_": "system.uname",
      "snmp_community": "",
      "ports": "10050",

```



```

        "snmpv3_securityname": "",
        "snmpv3_securitylevel": "0",
        "snmpv3_authpassphrase": "",
        "snmpv3_privpassphrase": "",
        "uniq": "0",
        "snmpv3_authprotocol": "0",
        "snmpv3_privprotocol": "0",
        "snmpv3_contextname": "",
        "host_source": "2",
        "name_source": "3",
        "allow_redirect": "0"
    }
]
},
"id": 1
}

```

See also

- [Discovered host](#)
- [Discovery check](#)

Source

CDRule::get() in `ui/include/classes/api/services/CDRule.php`.

drule.update

Description

object drule.update(object/array discoveryRules)

This method allows to update existing discovery rules.

Note:

This method is only available to *Admin* and *Super admin* user types. Permissions to call the method can be revoked in user role settings. See [User roles](#) for more information.

Parameters

(object/array) Discovery rule properties to be updated.

The `druleid` property must be defined for each discovery rule, all other properties are optional. Only the passed properties will be updated, all others will remain unchanged.

Additionally to the [standard discovery rule properties](#), the method accepts the following parameters.

Parameter	Type	Description
dchecks	array	Discovery checks to replace existing checks.

Return values

(object) Returns an object containing the IDs of the updated discovery rules under the `druleids` property.

Examples

Change the IP range of a discovery rule

Change the IP range of a discovery rule to "192.168.2.1-255".

Request:

```

{
  "jsonrpc": "2.0",
  "method": "drule.update",
  "params": {

```

```
    "druleid": "6",
    "iprange": "192.168.2.1-255"
  },
  "id": 1
}
```

Response:

```
{
  "jsonrpc": "2.0",
  "result": {
    "druleids": [
      "6"
    ]
  },
  "id": 1
}
```

See also

- [Discovery check](#)

Source

`CDRule::update()` in `ui/include/classes/api/services/CDRule.php`.

Event

This class is designed to work with events.

Object references:

- [Event](#)
- [Event tag](#)
- [Media type URL](#)

Available methods:

- `event.get` - retrieve events
- `event.acknowledge` - acknowledge events

Event object

The following objects are directly related to the event API.

Event

Note:

Events are created by the Zabbix server and cannot be modified via the API.

The event object has the following properties.

Property	Type	Description
eventid	ID	ID of the event.
source	integer	Type of the event.

Possible values:

- 0 - event created by a trigger;
- 1 - event created by a discovery rule;
- 2 - event created by active agent autoregistration;
- 3 - internal event;
- 4 - event created on service status update.

Property	Type	Description
object	integer	Type of object that is related to the event. Possible values if source is set to "event created by a trigger": 0 - trigger. Possible values if source is set to "event created by a discovery rule": 1 - discovered host; 2 - discovered service. Possible values if source is set to "event created by active agent autoregistration": 3 - auto-registered host. Possible values if source is set to "internal event": 0 - trigger; 4 - item; 5 - LLD rule. Possible values if source is set to "event created on service status update": 6 - service.
objectid	ID	ID of the related object.
acknowledged	integer	Whether the event has been acknowledged.
clock	timestamp	Time when the event was created.
ns	integer	Nanoseconds when the event was created.
name	string	Resolved event name.
value	integer	State of the related object. Possible values if source is set to "event created by a trigger" or "event created on service status update": 0 - OK; 1 - problem. Possible values if source is set to "event created by a discovery rule": 0 - host or service up; 1 - host or service down; 2 - host or service discovered; 3 - host or service lost. Possible values if source is set to "internal event": 0 - "normal" state; 1 - "unknown" or "not supported" state.
severity	integer	Property behavior: - <i>supported</i> if source is set to "event created by a trigger", "event created by a discovery rule", "internal event", or "event created on service status update" Event current severity. Possible values: 0 - not classified; 1 - information; 2 - warning; 3 - average; 4 - high; 5 - disaster.
r_eventid	ID	ID of the recovery event.
c_eventid	ID	ID of the event that was used to override (close) current event under global correlation rule. See <code>correlationid</code> to identify exact correlation rule. This parameter is only defined when the event is closed by global correlation rule.

Property	Type	Description
cause_eventid	ID	ID of the cause event.
correlationid	ID	ID of the correlation rule that generated closing of the problem. This parameter is only defined when the event is closed by global correlation rule.
userid	ID	ID of the user that closed the event (if the event was closed manually).
suppressed	integer	Whether the event is suppressed. Possible values: 0 - event is in normal state; 1 - event is suppressed.
opdata	string	Operational data with expanded macros.
urls	array	Active media type URLs .

Event tag

The event tag object has the following properties.

Property	Type	Description
tag	string	Event tag name.
value	string	Event tag value.

Media type URL

The media type URL object has the following properties.

Property	Type	Description
name	string	Media type defined URL name.
url	string	Media type defined URL value.

Results will contain entries only for active media types with enabled event menu entry. Macro used in properties will be expanded, but if one of the properties contains an unexpanded macro, both properties will be excluded from results. For supported macros, see *Supported macros*.

event.acknowledge

Description

`object event.acknowledge(object/array parameters)`

This method allows to update events. The following update actions can be performed:

- Close event. If event is already resolved, this action will be skipped.
- Acknowledge event. If event is already acknowledged, this action will be skipped.
- Unacknowledge event. If event is not acknowledged, this action will be skipped.
- Add message.
- Change event severity. If event already has same severity, this action will be skipped.
- Suppress event. If event is already suppressed, this action will be skipped.
- Unsuppress event. If event is not suppressed, this action will be skipped.

Attention:

Only trigger events can be updated.

Only problem events can be updated.

Read/Write rights for trigger are required to close the event or to change event's severity.

To close an event, manual close should be allowed in the trigger.

Note:

This method is available to users of any type. Permissions to call the method can be revoked in user role settings. See **User roles** for more information.

Parameters

(object/array) Parameters containing the IDs of the events and update operations that should be performed.

Parameter	Type	Description
eventids	ID/array	IDs of the events to acknowledge.
action	integer	<p>Parameter behavior: - <i>required</i> Event update action(s).</p> <p>Possible bitmap values: 1 - close problem; 2 - acknowledge event; 4 - add message; 8 - change severity; 16 - unacknowledge event; 32 - suppress event; 64 - unsuppress event; 128 - change event rank to cause; 256 - change event rank to symptom.</p> <p>This is a bitmask field; any sum of possible bitmap values is acceptable (for example, 34 for acknowledge and suppress event).</p> <p>Parameter behavior: - <i>required</i> Cause event ID.</p> <p>Parameter behavior: - <i>required</i> if <code>action</code> contains the "change event rank to symptom" bit Text of the message.</p> <p>Parameter behavior: - <i>required</i> if <code>action</code> contains the "add message" bit New severity for events.</p> <p>Possible values: 0 - not classified; 1 - information; 2 - warning; 3 - average; 4 - high; 5 - disaster.</p> <p>Parameter behavior: - <i>required</i> if <code>action</code> contains the "change severity" bit Unix timestamp until which event must be suppressed.</p> <p>If set to "0", the suppression will be indefinite.</p> <p>Parameter behavior: - <i>required</i> if <code>action</code> contains the "suppress event" bit</p>
cause_eventid	ID	
message	string	
severity	integer	
suppress_until	integer	

Return values

(object) Returns an object containing the IDs of the updated events under the `eventids` property.

Examples

Acknowledging an event

Acknowledge a single event and leave a message.

Request:

```
{
  "jsonrpc": "2.0",
  "method": "event.acknowledge",
  "params": {
    "eventids": "20427",
    "action": 6,
    "message": "Problem resolved."
  },
  "id": 1
}
```

Response:

```
{
  "jsonrpc": "2.0",
  "result": {
    "eventids": [
      "20427"
    ]
  },
  "id": 1
}
```

Changing event's severity

Change severity for multiple events and leave a message.

Request:

```
{
  "jsonrpc": "2.0",
  "method": "event.acknowledge",
  "params": {
    "eventids": ["20427", "20428"],
    "action": 12,
    "message": "Maintenance required to fix it.",
    "severity": 4
  },
  "id": 1
}
```

Response:

```
{
  "jsonrpc": "2.0",
  "result": {
    "eventids": [
      "20427",
      "20428"
    ]
  },
  "id": 1
}
```

Source

CEvent::acknowledge() in *ui/include/classes/api/services/CEvent.php*.

event.get

Description

integer/array event.get(object parameters)

The method allows to retrieve events according to the given parameters.

Attention:

This method may return events of a deleted entity if these events have not been removed by the housekeeper yet.

Note:

This method is available to users of any type. Permissions to call the method can be revoked in user role settings. See [User roles](#) for more information.

Parameters

(object) Parameters defining the desired output.

The method supports the following parameters.

Parameter	Type	Description
eventids	ID/array	Return only events with the given IDs.
groupids	ID/array	Return only events created by objects that belong to the given host groups.
hostids	ID/array	Return only events created by objects that belong to the given hosts.
objectids	ID/array	Return only events created by the given objects.
source	integer	Return only events with the given type. Refer to the event object page for a list of supported event types.
object	integer	Default: 0 - trigger events. Return only events created by objects of the given type. Refer to the event object page for a list of supported object types.
acknowledged	boolean	Default: 0 - trigger. If set to <code>true</code> return only acknowledged events.
action	integer	Return only events for which the given event update actions have been performed. For multiple actions, use a sum of any acceptable bitmap values as bitmask (for example, 34 for acknowledge and suppress event).
action_userids	ID/array	Return only events with the given IDs of users who performed the event update actions.
suppressed	boolean	<code>true</code> - return only suppressed events; <code>false</code> - return events in the normal state.
symptom	boolean	<code>true</code> - return only symptom events; <code>false</code> - return only cause events.
severities	integer/array	Return only events with the given event severities. Applies only if object is trigger.
trigger_severities	integer/array	Return only events with the given trigger severities. Applies only if object is trigger.
evaltype	integer	Rules for tag searching. Possible values: 0 - (default) And/Or; 2 - Or.
tags	array	Return only events with the given tags. Exact match by tag and case-insensitive search by value and operator. Format: [{"tag": "<tag>", "value": "<value>", "operator": "<operator>"}, ...]. An empty array returns all events. Possible operator types: 0 - (default) Like; 1 - Equal; 2 - Not like; 3 - Not equal 4 - Exists; 5 - Not exists.

Parameter	Type	Description
eventid_from	string	Return only events with IDs greater or equal to the given ID.
eventid_till	string	Return only events with IDs less or equal to the given ID.
time_from	timestamp	Return only events that have been created after or at the given time.
time_till	timestamp	Return only events that have been created before or at the given time.
problem_time_from	timestamp	Returns only events that were in the problem state starting with <code>problem_time_from</code> . Applies only if the source is trigger event and object is trigger. Mandatory if <code>problem_time_till</code> is specified.
problem_time_till	timestamp	Returns only events that were in the problem state until <code>problem_time_till</code> . Applies only if the source is trigger event and object is trigger. Mandatory if <code>problem_time_from</code> is specified.
value	integer/array	Return only events with the given values.
selectAcknowledges	query	Return an <code>acknowledges</code> property with event updates. Event updates are sorted in reverse chronological order.
		<p>The event update object has the following properties:</p> <ul style="list-style-type: none"> <code>acknowledgeid</code> - (ID) acknowledgment's ID; <code>userid</code> - (ID) ID of the user that updated the event; <code>clock</code> - (timestamp) time when the event was updated; <code>message</code> - (string) text of the message; <code>action</code> - (integer) update action that was performed, see <code>event.acknowledge</code>; <code>old_severity</code> - (integer) event severity before this update action; <code>new_severity</code> - (integer) event severity after this update action; <code>suppress_until</code> - (timestamp) time till event will be suppressed; <code>taskid</code> - (ID) ID of task if current event is undergoing a rank change; <code>username</code> - (string) username of the user that updated the event; <code>name</code> - (string) name of the user that updated the event; <code>surname</code> - (string) surname of the user that updated the event.
selectAlerts	query	Supports count. Return an <code>alerts</code> property with alerts generated by the event. Alerts are sorted in reverse chronological order.
selectHosts	query	Return a <code>hosts</code> property with hosts containing the object that created the event. Supported only for events generated by triggers, items or LLD rules.
selectRelatedObject	query	Return a <code>relatedObject</code> property with the object that created the event. The type of object returned depends on the event type.
selectSuppressionData	query	Return a <code>suppression_data</code> property with the list of active maintenances and manual suppressions:
		<ul style="list-style-type: none"> <code>maintenanceid</code> - (ID) ID of the maintenance; <code>userid</code> - (ID) ID of user who suppressed the event; <code>suppress_until</code> - (integer) time until the event is suppressed.
selectTags	query	Return a <code>tags</code> property with event tags.
filter	object	Return only those results that exactly match the given filter.
		Accepts an object, where the keys are property names, and the values are either a single value or an array of values to match against.
sortfield	string/array	Does not support properties of text <code>data type</code> . Sort the result by the given properties.
		Possible values: <code>eventid</code> , <code>objectid</code> , <code>clock</code> .
		Possible values when used together with <code>groupBy</code> : <code>objectid</code> .
		Possible values when used together with <code>countOutput</code> and <code>groupBy</code> : <code>objectid</code> , <code>rowcount</code> .
groupBy	string/array	Group the results by the given properties. The specified properties will be returned in the results.
		Possible values: <code>objectid</code> .

Parameter	Type	Description
countOutput	boolean	These parameters being common for all get methods are described in detail in the reference commentary page.
editable	boolean	
excludeSearch	boolean	
limit	integer	
output	query	
preservekeys	boolean	
search	object	
searchByAny	boolean	
searchWildcardsEnabled	boolean	
sortorder	string/array	
startSearch	boolean	

Return values

(integer/array) Returns either:

- an array of objects;
- the count of retrieved objects, if the countOutput parameter has been used, but the groupBy parameter has not been used;
- an array of objects with aggregation results, if the groupBy parameter has been used.

Examples

Retrieving trigger events

Retrieve the latest events from trigger "22395".

Request:

```
{
  "jsonrpc": "2.0",
  "method": "event.get",
  "params": {
    "output": "extend",
    "selectAcknowledges": "extend",
    "selectSuppressionData": "extend",
    "selectTags": "extend",
    "objectids": "22395",
    "sortfield": ["clock", "eventid"],
    "sortorder": "DESC"
  },
  "id": 1
}
```

Response:

```
{
  "jsonrpc": "2.0",
  "result": [
    {
      "eventid": "20",
      "source": "0",
      "object": "0",
      "objectid": "22395",
      "clock": "1728658089",
      "value": "0",
      "acknowledged": "0",
      "ns": "461809482",
      "name": "Load average is too high (per CPU load over 1.5 for 5m)",
      "severity": "0",
      "r_eventid": "0",
      "c_eventid": "0",
      "correlationid": "0",
      "userid": "0",
    }
  ]
}
```

```

"cause_eventid": "0",
"acknowledges": [],
"opdata": "Load averages(1m 5m 15m): (1.6328 3.0522 2.2515), # of CPUs: 2",
"suppression_data": [],
"suppressed": "0",
"tags": [
  {
    "tag": "scope",
    "value": "capacity"
  },
  {
    "tag": "scope",
    "value": "performance"
  },
  {
    "tag": "component",
    "value": "cpu"
  },
  {
    "tag": "class",
    "value": "os"
  },
  {
    "tag": "target",
    "value": "linux"
  }
],
"urls": []
},
{
  "eventid": "4",
  "source": "0",
  "object": "0",
  "objectid": "22395",
  "clock": "1728657737",
  "value": "1",
  "acknowledged": "1",
  "ns": "460759366",
  "name": "Load average is too high (per CPU load over 1.5 for 5m)",
  "severity": "3",
  "r_eventid": "20",
  "c_eventid": "0",
  "correlationid": "0",
  "userid": "0",
  "cause_eventid": "0",
  "acknowledges": [
    {
      "acknowledgeid": "1",
      "userid": "1",
      "clock": "1728657938",
      "message": "Testing environment. Please disregard this alert.",
      "action": "38",
      "old_severity": "0",
      "new_severity": "0",
      "suppress_until": "1728744338",
      "taskid": "0",
      "username": "Admin",
      "name": "Zabbix",
      "surname": "Administrator"
    }
  ]
},
"opdata": "Load averages(1m 5m 15m): (1.6328 3.0522 2.2515), # of CPUs: 2",

```

```

    "suppression_data": [
      {
        "maintenanceid": "0",
        "suppress_until": "1728744338",
        "userid": "1"
      }
    ],
    "suppressed": "1",
    "tags": [
      {
        "tag": "scope",
        "value": "capacity"
      },
      {
        "tag": "scope",
        "value": "performance"
      },
      {
        "tag": "component",
        "value": "cpu"
      },
      {
        "tag": "class",
        "value": "os"
      },
      {
        "tag": "target",
        "value": "linux"
      }
    ],
    "urls": []
  }
],
  "id": 1
}

```

Retrieving events by time period

Retrieve all events that have been created between October 9 and 10, 2012, in reverse chronological order.

Request:

```

{
  "jsonrpc": "2.0",
  "method": "event.get",
  "params": {
    "output": "extend",
    "time_from": "1349797228",
    "time_till": "1350661228",
    "sortfield": ["clock", "eventid"],
    "sortorder": "desc"
  },
  "id": 1
}

```

Response:

```

{
  "jsonrpc": "2.0",
  "result": [
    {
      "eventid": "20616",
      "source": "0",
      "object": "0",
      "objectid": "14282",

```

```

    "clock": "1350477814",
    "value": "1",
    "acknowledged": "0",
    "ns": "0",
    "name": "Less than 25% free in the history cache",
    "severity": "3",
    "r_eventid": "0",
    "c_eventid": "0",
    "correlationid": "0",
    "userid": "0",
    "cause_eventid": "0",
    "opdata": "",
    "suppressed": "0",
    "urls": []
  },
  {
    "eventid": "20617",
    "source": "0",
    "object": "0",
    "objectid": "14283",
    "clock": "1350477814",
    "value": "0",
    "acknowledged": "0",
    "ns": "0",
    "name": "Zabbix trapper processes more than 75% busy",
    "severity": "3",
    "r_eventid": "0",
    "c_eventid": "0",
    "correlationid": "0",
    "userid": "0",
    "cause_eventid": "0",
    "opdata": "",
    "suppressed": "0",
    "urls": []
  },
  {
    "eventid": "20618",
    "source": "0",
    "object": "0",
    "objectid": "14284",
    "clock": "1350477815",
    "value": "1",
    "acknowledged": "0",
    "ns": "0",
    "name": "High ICMP ping loss",
    "severity": "3",
    "r_eventid": "0",
    "c_eventid": "0",
    "correlationid": "0",
    "userid": "0",
    "cause_eventid": "0",
    "opdata": "",
    "suppressed": "0",
    "urls": []
  }
],
  "id": 1
}

```

Retrieving events acknowledged by specified user

Retrieving events acknowledged by user with ID=10

Request:

```
{
  "jsonrpc": "2.0",
  "method": "event.get",
  "params": {
    "output": "extend",
    "action": 2,
    "action_userids": [10],
    "selectAcknowledges": ["userid", "action"],
    "sortfield": ["eventid"],
    "sortorder": "DESC"
  },
  "id": 1
}
```

Response:

```
{
  "jsonrpc": "2.0",
  "result": [
    {
      "eventid": "1248566",
      "source": "0",
      "object": "0",
      "objectid": "15142",
      "clock": "1472457242",
      "ns": "209442442",
      "r_eventid": "1245468",
      "r_clock": "1472457285",
      "r_ns": "125644870",
      "correlationid": "0",
      "userid": "10",
      "name": "Zabbix agent on localhost is unreachable for 5 minutes",
      "acknowledged": "1",
      "severity": "3",
      "cause_eventid": "0",
      "acknowledges": [
        {
          "userid": "10",
          "action": "2"
        }
      ],
      "opdata": "",
      "suppressed": "0",
      "urls": []
    }
  ],
  "id": 1
}
```

Retrieving top triggers with problem event count

Retrieve the top 5 triggers that have severities "Warning", "Average", "High", or "Disaster", together with the number of problem events within a specified time period.

Request:

```
{
  "jsonrpc": "2.0",
  "method": "event.get",
  "params": {
    "countOutput": true,
    "groupBy": "objectid",
    "source": 0,
    "object": 0,
    "value": 1,

```

```
    "time_from": 1672531200,
    "time_till": 1677628800,
    "trigger_severities": [2, 3, 4, 5],
    "sortfield": ["rowcount"],
    "sortorder": "DESC",
    "limit": 5
  },
  "id": 1
}
```

Response:

```
{
  "jsonrpc": "2.0",
  "result": [
    {
      "objectid": "232124",
      "rowcount": "27"
    },
    {
      "objectid": "29055",
      "rowcount": "23"
    },
    {
      "objectid": "253731",
      "rowcount": "18"
    },
    {
      "objectid": "254062",
      "rowcount": "11"
    },
    {
      "objectid": "23216",
      "rowcount": "7"
    }
  ],
  "id": 1
}
```

See also

- [Alert](#)
- [Item](#)
- [Host](#)
- [LLD rule](#)
- [Service](#)
- [Trigger](#)

Source

`CEvent::get()` in `ui/include/classes/api/services/CEvent.php`.

Graph

This class is designed to work with graphs.

Object references:

- [Graph](#)

Available methods:

- [graph.create](#) - create new graphs
- [graph.delete](#) - delete graphs
- [graph.get](#) - retrieve graphs
- [graph.update](#) - update graphs

Graph object

The following objects are directly related to the graph API.

Graph

The graph object has the following properties.

Property	Type	Description
graphid	ID	ID of the graph.
height	integer	<p>Property behavior:</p> <ul style="list-style-type: none">- <i>read-only</i>- <i>required</i> for update operations Height of the graph in pixels.
name	string	<p>Property behavior:</p> <ul style="list-style-type: none">- <i>required</i> for create operations Name of the graph.
width	integer	<p>Property behavior:</p> <ul style="list-style-type: none">- <i>required</i> for create operations Width of the graph in pixels.
flags	integer	<p>Property behavior:</p> <ul style="list-style-type: none">- <i>required</i> for create operations Origin of the graph.
graphtype	integer	<p>Possible values:</p> <ul style="list-style-type: none">0 - (<i>default</i>) a plain graph;4 - a discovered graph. <p>Property behavior:</p> <ul style="list-style-type: none">- <i>read-only</i> Graph's layout type.
percent_left	float	<p>Possible values:</p> <ul style="list-style-type: none">0 - (<i>default</i>) normal;1 - stacked;2 - pie;3 - exploded. Left percentile.
percent_right	float	<p>Default: 0.</p> Right percentile.
show_3d	integer	<p>Default: 0.</p> Whether to show pie and exploded graphs in 3D.
show_legend	integer	<p>Possible values:</p> <ul style="list-style-type: none">0 - (<i>default</i>) show in 2D;1 - show in 3D. Whether to show the legend on the graph.
show_work_period	integer	<p>Possible values:</p> <ul style="list-style-type: none">0 - hide;1 - (<i>default</i>) show. Whether to show the working time on the graph.
		<p>Possible values:</p> <ul style="list-style-type: none">0 - hide;1 - (<i>default</i>) show.

Property	Type	Description
show_triggers	integer	Whether to show the trigger line on the graph. Possible values: 0 - hide; 1 - <i>(default)</i> show.
templateid	ID	ID of the parent template graph. Property behavior: - <i>read-only</i>
yaxismax	float	The fixed maximum value for the Y axis. Default: 100.
yaxismin	float	The fixed minimum value for the Y axis. Default: 0.
ymax_itemid	ID	ID of the item that is used as the maximum value for the Y axis. If a user has no access to the specified item, the graph is rendered as if <code>ymin_type</code> is set to "calculated".
ymin_type	integer	Maximum value calculation method for the Y axis. Possible values: 0 - <i>(default)</i> calculated; 1 - fixed; 2 - item.
ymin_itemid	ID	ID of the item that is used as the minimum value for the Y axis. If a user has no access to the specified item, the graph is rendered as if <code>ymin_type</code> is set to "calculated".
ymin_type	integer	Minimum value calculation method for the Y axis. Possible values: 0 - <i>(default)</i> calculated; 1 - fixed; 2 - item.
uuid	string	Universal unique identifier, used for linking imported graphs to already existing ones. Auto-generated, if not given. Property behavior: - <i>supported</i> if the graph belongs to a template

graph.create

Description

`object graph.create(object/array graphs)`

This method allows to create new graphs.

Note:

This method is only available to *Admin* and *Super admin* user types. Permissions to call the method can be revoked in user role settings. See [User roles](#) for more information.

Parameters

(object/array) Graphs to create.

Additionally to the [standard graph properties](#), the method accepts the following parameters.

Parameter	Type	Description
gitems	array	Graph items to be created for the graph.

Parameter behavior:
- *required*

Return values

(object) Returns an object containing the IDs of the created graphs under the `graphids` property. The order of the returned IDs matches the order of the passed graphs.

Examples

Creating a graph

Create a graph with two items.

Request:

```
{
  "jsonrpc": "2.0",
  "method": "graph.create",
  "params": {
    "name": "MySQL bandwidth",
    "width": 900,
    "height": 200,
    "gitems": [
      {
        "itemid": "22828",
        "color": "00AA00"
      },
      {
        "itemid": "22829",
        "color": "3333FF"
      }
    ]
  },
  "id": 1
}
```

Response:

```
{
  "jsonrpc": "2.0",
  "result": {
    "graphids": [
      "652"
    ]
  },
  "id": 1
}
```

See also

- [Graph item](#)

Source

CGraph::create() in `ui/include/classes/api/services/CGraph.php`.

graph.delete

Description

object `graph.delete(array graphIds)`

This method allows to delete graphs.

Note:

This method is only available to *Admin* and *Super admin* user types. Permissions to call the method can be revoked in user role settings. See [User roles](#) for more information.

Parameters

(array) IDs of the graphs to delete.

Return values

(object) Returns an object containing the IDs of the deleted graphs under the `graphids` property.

Examples**Deleting multiple graphs**

Delete two graphs.

Request:

```
{
  "jsonrpc": "2.0",
  "method": "graph.delete",
  "params": [
    "652",
    "653"
  ],
  "id": 1
}
```

Response:

```
{
  "jsonrpc": "2.0",
  "result": {
    "graphids": [
      "652",
      "653"
    ]
  },
  "id": 1
}
```

Source

`CGraph::delete()` in `ui/include/classes/api/services/CGraph.php`.

graph.get**Description**

`integer/array graph.get(object parameters)`

The method allows to retrieve graphs according to the given parameters.

Note:

This method is available to users of any type. Permissions to call the method can be revoked in user role settings. See [User roles](#) for more information.

Parameters

(object) Parameters defining the desired output.

The method supports the following parameters.

Parameter	Type	Description
<code>graphids</code>	ID/array	Return only graphs with the given IDs.
<code>groupids</code>	ID/array	Return only graphs that belong to hosts or templates in the given host groups or template groups.

Parameter	Type	Description
templateids	ID/array	Return only graph that belong to the given templates.
hostids	ID/array	Return only graphs that belong to the given hosts.
itemids	ID/array	Return only graphs that contain the given items.
templated	boolean	If set to true return only graphs that belong to templates.
inherited	boolean	If set to true return only graphs inherited from a template.
expandName	flag	Expand macros in the graph name.
selectHostGroups	query	Return a <code>hostgroups</code> property with the host groups that the graph belongs to.
selectTemplateGroups	query	Return a <code>templategroups</code> property with the template groups that the graph belongs to.
selectTemplates	query	Return a <code>templates</code> property with the templates that the graph belongs to.
selectHosts	query	Return a <code>hosts</code> property with the hosts that the graph belongs to.
selectItems	query	Return an <code>items</code> property with the items used in the graph.
selectGraphDiscovery	query	Return a <code>graphDiscovery</code> property with the graph discovery object. The graph discovery objects links the graph to a graph prototype from which it was created.
		It has the following properties: <code>graphid</code> - (ID) ID of the graph; <code>parent_graphid</code> - (ID) ID of the graph prototype from which the graph has been created; <code>lastcheck</code> - (timestamp) time when the graph was last discovered; <code>status</code> - (int) graph discovery status: 0 - (default) graph is discovered, 1 - graph is not discovered anymore; <code>ts_delete</code> - (timestamp) time when a graph that is no longer discovered will be deleted.
selectGraphItems	query	Return a <code>gitems</code> property with the items used in the graph.
selectDiscoveryRule	query	Return a <code>discoveryRule</code> property with the low-level discovery rule that created the graph.
filter	object	Return only those results that exactly match the given filter.
		Accepts an object, where the keys are property names, and the values are either a single value or an array of values to match against.
		Does not support properties of text <code>data type</code> .
		Supports additional properties: <code>host</code> - technical name of the host that the graph belongs to; <code>hostid</code> - ID of the host that the graph belongs to.
sortfield	string/array	Sort the result by the given properties.
		Possible values: <code>graphid</code> , <code>name</code> , <code>graphtype</code> .
countOutput	boolean	These parameters being common for all <code>get</code> methods are described in detail in the reference commentary page.
editable	boolean	
excludeSearch	boolean	
limit	integer	
output	query	
preservekeys	boolean	
search	object	
searchByAny	boolean	
searchWildcardsEnabled	boolean	
sortorder	string/array	
startSearch	boolean	

Return values

(integer/array) Returns either:

- an array of objects;

- the count of retrieved objects, if the countOutput parameter has been used.

Examples

Retrieving graphs from hosts

Retrieve all graphs from host "10107" and sort them by name.

Request:

```
{
  "jsonrpc": "2.0",
  "method": "graph.get",
  "params": {
    "output": "extend",
    "hostids": 10107,
    "sortfield": "name"
  },
  "id": 1
}
```

Response:

```
{
  "jsonrpc": "2.0",
  "result": [
    {
      "graphid": "612",
      "name": "CPU jumps",
      "width": "900",
      "height": "200",
      "yaxismin": "0",
      "yaxismax": "100",
      "templateid": "439",
      "show_work_period": "1",
      "show_triggers": "1",
      "graphtype": "0",
      "show_legend": "1",
      "show_3d": "0",
      "percent_left": "0",
      "percent_right": "0",
      "ymin_type": "0",
      "ymax_type": "0",
      "ymin_itemid": "0",
      "ymax_itemid": "0",
      "flags": "0"
    },
    {
      "graphid": "613",
      "name": "CPU load",
      "width": "900",
      "height": "200",
      "yaxismin": "0",
      "yaxismax": "100",
      "templateid": "433",
      "show_work_period": "1",
      "show_triggers": "1",
      "graphtype": "0",
      "show_legend": "1",
      "show_3d": "0",
      "percent_left": "0",
      "percent_right": "0",
      "ymin_type": "1",
      "ymax_type": "0",
      "ymin_itemid": "0",
      "ymax_itemid": "0"
    }
  ]
}
```

```

    "flags": "0"
  },
  {
    "graphid": "614",
    "name": "CPU utilization",
    "width": "900",
    "height": "200",
    "yaxismin": "0",
    "yaxismax": "100",
    "templateid": "387",
    "show_work_period": "1",
    "show_triggers": "0",
    "graphtype": "1",
    "show_legend": "1",
    "show_3d": "0",
    "percent_left": "0",
    "percent_right": "0",
    "ymin_type": "1",
    "ymax_type": "1",
    "ymin_itemid": "0",
    "ymax_itemid": "0",
    "flags": "0"
  },
  {
    "graphid": "645",
    "name": "Disk space usage /",
    "width": "600",
    "height": "340",
    "yaxismin": "0",
    "yaxismax": "0",
    "templateid": "0",
    "show_work_period": "0",
    "show_triggers": "0",
    "graphtype": "2",
    "show_legend": "1",
    "show_3d": "1",
    "percent_left": "0",
    "percent_right": "0",
    "ymin_type": "0",
    "ymax_type": "0",
    "ymin_itemid": "0",
    "ymax_itemid": "0",
    "flags": "4"
  }
],
"id": 1
}

```

See also

- [Discovery rule](#)
- [Graph item](#)
- [Item](#)
- [Host](#)
- [Host group](#)
- [Template](#)
- [Template group](#)

Source

CGraph::get() in *ui/include/classes/api/services/CGraph.php*.

graph.update

Description

`object graph.update(object/array graphs)`

This method allows to update existing graphs.

Note:

This method is only available to *Admin* and *Super admin* user types. Permissions to call the method can be revoked in user role settings. See [User roles](#) for more information.

Parameters

(object/array) Graph properties to be updated.

The `graphid` property must be defined for each graph, all other properties are optional. Only the passed properties will be updated, all others will remain unchanged.

Additionally to the [standard graph properties](#) the method accepts the following parameters.

Parameter	Type	Description
<code>gitems</code>	array	Graph items to replace existing graph items. If a graph item has the <code>gitemid</code> property defined it will be updated, otherwise a new graph item will be created.

Return values

(object) Returns an object containing the IDs of the updated graphs under the `graphids` property.

Examples

Setting the maximum for the Y scale

Set the maximum of the Y scale to a fixed value of 100.

Request:

```
{
  "jsonrpc": "2.0",
  "method": "graph.update",
  "params": {
    "graphid": "439",
    "ymax_type": 1,
    "yaxismax": 100
  },
  "id": 1
}
```

Response:

```
{
  "jsonrpc": "2.0",
  "result": {
    "graphids": [
      "439"
    ]
  },
  "id": 1
}
```

Source

`CGraph::update()` in `ui/include/classes/api/services/CGraph.php`.

Graph item

This class is designed to work with graph items.

Object references:

- [Graph item](#)

Available methods:

- [graphitem.get](#) - retrieve graph items

Graph item object

The following objects are directly related to the `graphitem` API.

Graph item

Note:

Graph items can only be modified via the `graph` API.

The graph item object has the following properties.

Property	Type	Description
<code>gitemid</code>	ID	ID of the graph item.
<code>color</code>	string	<p>Property behavior: - <i>read-only</i></p> <p>Graph item's draw color as a hexadecimal color code.</p>
<code>itemid</code>	ID	<p>Property behavior: - <i>required</i> for create operations</p> <p>ID of the item.</p>
<code>calc_fnc</code>	integer	<p>Property behavior: - <i>required</i> for create operations</p> <p>Value of the item that will be displayed.</p> <p>Possible values: 1 - minimum value; 2 - (<i>default</i>) average value; 4 - maximum value; 7 - all values;</p>
<code>drawtype</code>	integer	<p>9 - last value, used only by pie and exploded graphs.</p> <p>Draw style of the graph item.</p> <p>Possible values: 0 - (<i>default</i>) line; 1 - filled region; 2 - bold line; 3 - dot; 4 - dashed line; 5 - gradient line.</p>
<code>graphid</code>	ID	ID of the graph that the graph item belongs to.
<code>sortorder</code>	integer	Position of the item in the graph.
<code>type</code>	integer	<p>Default: starts with "0" and increases by one with each entry.</p> <p>Type of graph item.</p> <p>Possible values: 0 - (<i>default</i>) simple;</p>
<code>yaxisside</code>	integer	<p>2 - graph sum, used only by pie and exploded graphs.</p> <p>Side of the graph where the graph item's Y scale will be drawn.</p> <p>Possible values: 0 - (<i>default</i>) left side; 1 - right side.</p>

graphitem.get

Description

integer/array graphitem.get(object parameters)

The method allows to retrieve graph items according to the given parameters.

Note:

This method is available to users of any type. Permissions to call the method can be revoked in user role settings. See [User roles](#) for more information.

Parameters

(object) Parameters defining the desired output.

The method supports the following parameters.

Parameter	Type	Description
graphids	ID/array	Return only graph items that belong to the given graphs.
itemids	ID/array	Return only graph items with the given item IDs.
type	integer	Return only graph items with the given type.
		Refer to the graph item object page for a list of supported graph item types.
selectGraphs	query	Return a graphs property with an array of graphs that the item belongs to.
sortfield	string/array	Sort the result by the given properties.
countOutput	boolean	Possible values: <code>gitemid</code> . These parameters being common for all get methods are described in detail in the reference commentary page .
editable	boolean	
limit	integer	
output	query	
preservekeys	boolean	
sortorder	string/array	

Return values

(integer/array) Returns either:

- an array of objects;
- the count of retrieved objects, if the `countOutput` parameter has been used.

Examples

Retrieving graph items from a graph

Retrieve all graph items used in a graph with additional information about the item and the host.

Request:

```
{
  "jsonrpc": "2.0",
  "method": "graphitem.get",
  "params": {
    "output": "extend",
    "graphids": "387"
  },
  "id": 1
}
```

Response:

```
{
  "jsonrpc": "2.0",
```



```

"result": [
  {
    "gitemid": "1242",
    "graphid": "387",
    "itemid": "22665",
    "drawtype": "1",
    "sortorder": "1",
    "color": "FF5555",
    "yaxisside": "0",
    "calc_fnc": "2",
    "type": "0"
  },
  {
    "gitemid": "1243",
    "graphid": "387",
    "itemid": "22668",
    "drawtype": "1",
    "sortorder": "2",
    "color": "55FF55",
    "yaxisside": "0",
    "calc_fnc": "2",
    "type": "0"
  },
  {
    "gitemid": "1244",
    "graphid": "387",
    "itemid": "22671",
    "drawtype": "1",
    "sortorder": "3",
    "color": "009999",
    "yaxisside": "0",
    "calc_fnc": "2",
    "type": "0"
  }
],
"id": 1
}

```

See also

- [Graph](#)

Source

`CGraphItem::get()` in `ui/include/classes/api/services/CGraphItem.php`.

Graph prototype

This class is designed to work with graph prototypes.

Object references:

- [Graph prototype](#)

Available methods:

- [graphprototype.create](#) - create new graph prototypes
- [graphprototype.delete](#) - delete graph prototypes
- [graphprototype.get](#) - retrieve graph prototypes
- [graphprototype.update](#) - update graph prototypes

Graph prototype object

The following objects are directly related to the graphprototype API.

Graph prototype

The graph prototype object has the following properties.

Property	Type	Description
graphid	ID	ID of the graph prototype.
height	integer	<p>Property behavior:</p> <ul style="list-style-type: none"> - <i>read-only</i> - <i>required</i> for update operations Height of the graph prototype in pixels.
name	string	<p>Property behavior:</p> <ul style="list-style-type: none"> - <i>required</i> for create operations Name of the graph prototype.
width	integer	<p>Property behavior:</p> <ul style="list-style-type: none"> - <i>required</i> for create operations Width of the graph prototype in pixels.
graphtype	integer	<p>Property behavior:</p> <ul style="list-style-type: none"> - <i>required</i> for create operations Graph prototypes's layout type.
percent_left	float	Possible values: 0 - (<i>default</i>) normal; 1 - stacked; 2 - pie; 3 - exploded. Left percentile.
percent_right	float	Default: 0. Right percentile.
show_3d	integer	Default: 0. Whether to show discovered pie and exploded graphs in 3D.
show_legend	integer	Possible values: 0 - (<i>default</i>) show in 2D; 1 - show in 3D. Whether to show the legend on the discovered graph.
show_work_period	integer	Possible values: 0 - hide; 1 - (<i>default</i>) show. Whether to show the working time on the discovered graph.
templateid	ID	Possible values: 0 - hide; 1 - (<i>default</i>) show. ID of the parent template graph prototype.
yaxismax	float	<p>Property behavior:</p> <ul style="list-style-type: none"> - <i>read-only</i> The fixed maximum value for the Y axis.
yaxismin	float	The fixed minimum value for the Y axis.
ymax_itemid	ID	ID of the item that is used as the maximum value for the Y axis.

If a user has no access to the specified item, the graph is rendered as if ymax_type is set to "calculated".

Property	Type	Description
ymax_type	integer	Maximum value calculation method for the Y axis. Possible values: 0 - (<i>default</i>) calculated; 1 - fixed; 2 - item.
ymin_itemid	ID	ID of the item that is used as the minimum value for the Y axis. If a user has no access to the specified item, the graph is rendered as if <code>ymin_type</code> is set to "calculated".
ymin_type	integer	Minimum value calculation method for the Y axis. Possible values: 0 - (<i>default</i>) calculated; 1 - fixed; 2 - item.
discover	integer	Graph prototype discovery status. Possible values: 0 - (<i>default</i>) new graphs will be discovered; 1 - new graphs will not be discovered and existing graphs will be marked as lost.
uuid	string	Universal unique identifier, used for linking imported graph prototypes to already existing ones. Auto-generated, if not given. Property behavior: - <i>supported</i> if the graph prototype belongs to a template

graphprototype.create

Description

object graphprototype.create(object/array graphPrototypes)

This method allows to create new graph prototypes.

Note:

This method is only available to *Admin* and *Super admin* user types. Permissions to call the method can be revoked in user role settings. See [User roles](#) for more information.

Parameters

(object/array) Graph prototypes to create.

Additionally to the [standard graph prototype properties](#), the method accepts the following parameters.

Parameter	Type	Description
gitems	array	Graph items to be created for the graph prototypes. Graph items can reference both items and item prototypes, but at least one item prototype must be present. Parameter behavior: - <i>required</i>

Return values

(object) Returns an object containing the IDs of the created graph prototypes under the `graphids` property. The order of the returned IDs matches the order of the passed graph prototypes.

Examples

Creating a graph prototype

Create a graph prototype with two items.

Request:

```
{
  "jsonrpc": "2.0",
  "method": "graphprototype.create",
  "params": {
    "name": "Disk space usage {#FSNAME}",
    "width": 900,
    "height": 200,
    "gitems": [
      {
        "itemid": "22828",
        "color": "00AA00"
      },
      {
        "itemid": "22829",
        "color": "3333FF"
      }
    ]
  },
  "id": 1
}
```

Response:

```
{
  "jsonrpc": "2.0",
  "result": {
    "graphids": [
      "652"
    ]
  },
  "id": 1
}
```

See also

- [Graph item](#)

Source

`CGraphPrototype::create()` in `ui/include/classes/api/services/CGraphPrototype.php`.

graphprototype.delete

Description

`object graphprototype.delete(array graphPrototypeIds)`

This method allows to delete graph prototypes.

Note:

This method is only available to *Admin* and *Super admin* user types. Permissions to call the method can be revoked in user role settings. See [User roles](#) for more information.

Parameters

(array) IDs of the graph prototypes to delete.

Return values

(object) Returns an object containing the IDs of the deleted graph prototypes under the `graphids` property.

Examples

Deleting multiple graph prototypes

Delete two graph prototypes.

Request:

```
{
  "jsonrpc": "2.0",
  "method": "graphprototype.delete",
  "params": [
    "652",
    "653"
  ],
  "id": 1
}
```

Response:

```
{
  "jsonrpc": "2.0",
  "result": {
    "graphids": [
      "652",
      "653"
    ]
  },
  "id": 1
}
```

Source

CGraphPrototype::delete() in *ui/include/classes/api/services/CGraphPrototype.php*.

graphprototype.get

Description

integer/array graphprototype.get(object parameters)

The method allows to retrieve graph prototypes according to the given parameters.

Note:

This method is available to users of any type. Permissions to call the method can be revoked in user role settings. See [User roles](#) for more information.

Parameters

(object) Parameters defining the desired output.

The method supports the following parameters.

Parameter	Type	Description
discoveryids	ID/array	Return only graph prototypes that belong to the given discovery rules.
graphids	ID/array	Return only graph prototypes with the given IDs.
groupids	ID/array	Return only graph prototypes that belong to hosts or templates in the given host groups or template groups.
hostids	ID/array	Return only graph prototypes that belong to the given hosts.
inherited	boolean	If set to true return only graph prototypes inherited from a template.
itemids	ID/array	Return only graph prototypes that contain the given item prototypes.
templated	boolean	If set to true return only graph prototypes that belong to templates.
templateids	ID/array	Return only graph prototypes that belong to the given templates.
selectDiscoveryRule	query	Return a discoveryRule property with the LLD rule that the graph prototype belongs to.
selectGraphItems	query	Return a gitems property with the graph items used in the graph prototype.
selectHostGroups	query	Return a hostgroups property with the host groups that the graph prototype belongs to.
selectHosts	query	Return a hosts property with the hosts that the graph prototype belongs to.

Parameter	Type	Description
selectItems	query	Return an <code>items</code> property with the <code>items</code> and <code>item prototypes</code> used in the graph prototype.
selectTemplateGroups	query	Return a <code>templategroups</code> property with the template groups that the graph prototype belongs to.
selectTemplates	query	Return a <code>templates</code> property with the templates that the graph prototype belongs to.
filter	object	Return only those results that exactly match the given filter. Accepts an object, where the keys are property names, and the values are either a single value or an array of values to match against. Does not support properties of text <code>data type</code> . Supports additional properties: <code>host</code> - technical name of the host that the graph prototype belongs to; <code>hostid</code> - ID of the host that the graph prototype belongs to. Sort the result by the given properties.
sortfield	string/array	Possible values: <code>graphid</code> , <code>name</code> , <code>graphtype</code> . These parameters being common for all get methods are described in detail in the reference commentary .
countOutput	boolean	
editable	boolean	
excludeSearch	boolean	
limit	integer	
output	query	
preservekeys	boolean	
search	object	
searchByAny	boolean	
searchWildcardsEnabled	boolean	
sortorder	string/array	
startSearch	boolean	

Return values

(integer/array) Returns either:

- an array of objects;
- the count of retrieved objects, if the `countOutput` parameter has been used.

Examples

Retrieving graph prototypes from an LLD rule

Retrieve all graph prototypes from an LLD rule.

Request:

```
{
  "jsonrpc": "2.0",
  "method": "graphprototype.get",
  "params": {
    "output": "extend",
    "discoveryids": "27426"
  },
  "id": 1
}
```

Response:

```
{
  "jsonrpc": "2.0",
  "result": [
    {
      "graphid": "1017",
      "parent_itemid": "27426",

```

```

        "name": "Disk space usage {#FSNAME}",
        "width": "600",
        "height": "340",
        "yaxismin": "0.0000",
        "yaxismax": "0.0000",
        "templateid": "442",
        "show_work_period": "0",
        "show_triggers": "0",
        "graphtype": "2",
        "show_legend": "1",
        "show_3d": "1",
        "percent_left": "0.0000",
        "percent_right": "0.0000",
        "ymin_type": "0",
        "ymax_type": "0",
        "ymin_itemid": "0",
        "ymax_itemid": "0",
        "discover": "0"
    }
],
    "id": 1
}

```

See also

- [Discovery rule](#)
- [Graph item](#)
- [Item](#)
- [Host](#)
- [Host group](#)
- [Template](#)
- [Template group](#)

Source

CGraphPrototype::get() in `ui/include/classes/api/services/CGraphPrototype.php`.

graphprototype.update

Description

object graphprototype.update(object/array graphPrototypes)

This method allows to update existing graph prototypes.

Note:

This method is only available to *Admin* and *Super admin* user types. Permissions to call the method can be revoked in user role settings. See [User roles](#) for more information.

Parameters

(object/array) Graph prototype properties to be updated.

The `graphid` property must be defined for each graph prototype, all other properties are optional. Only the passed properties will be updated, all others will remain unchanged.

Additionally to the [standard graph prototype properties](#), the method accepts the following parameters.

Parameter	Type	Description
gitems	array	Graph items to replace existing graph items. If a graph item has the <code>gitemid</code> property defined it will be updated, otherwise a new graph item will be created.

Return values

(object) Returns an object containing the IDs of the updated graph prototypes under the `graphids` property.

Examples

Changing the size of a graph prototype

Change the size of a graph prototype to 1100 to 400 pixels.

Request:

```
{
  "jsonrpc": "2.0",
  "method": "graphprototype.update",
  "params": {
    "graphid": "439",
    "width": 1100,
    "height": 400
  },
  "id": 1
}
```

Response:

```
{
  "jsonrpc": "2.0",
  "result": {
    "graphids": [
      "439"
    ]
  },
  "id": 1
}
```

Source

`CGraphPrototype::update()` in `ui/include/classes/api/services/CGraphPrototype.php`.

High availability node

This class is designed to work with server nodes that are part of a high availability cluster or a standalone server instance.

Object references:

- [High availability node](#)

Available methods:

- `hanode.get` - retrieve nodes

High availability node object

The following object is related to operating a High availability cluster of Zabbix servers.

High availability node

Note:

Nodes are created by the Zabbix server and cannot be modified via the API.

The High availability node object has the following properties.

Property	Type	Description
<code>ha_nodeid</code>	ID	ID of the node.
<code>name</code>	string	Name assigned to the node, using the <code>HANodeName</code> configuration entry of <code>zabbix_server.conf</code> . Empty for a server running in standalone mode.
<code>address</code>	string	IP or DNS name where the node connects from.
<code>port</code>	integer	Port on which the node is running.

Property	Type	Description
lastaccess	integer	Heartbeat time, that is, time of last update from the node. UTC timestamp.
status	integer	State of the node. Possible values: 0 - standby; 1 - stopped manually; 2 - unavailable; 3 - active.

hanode.get

Description

integer/array hanode.get(object parameters)

The method allows to retrieve a list of High availability cluster nodes according to the given parameters.

Note:

This method is only available to *Super admin* user types. See [User roles](#) for more information.

Parameters

(object) Parameters defining the desired output.

The method supports the following parameters.

Parameter	Type	Description
ha_nodeids	ID/array	Return only nodes with the given node IDs.
filter	object	Return only those results that exactly match the given filter. Accepts an object, where the keys are property names, and the values are either a single value or an array of values to match against.
sortfield	string/array	Supports properties: <code>name</code> , <code>address</code> , <code>status</code> . Sort the result by the given properties.
countOutput	flag	Possible values: <code>name</code> , <code>lastaccess</code> , <code>status</code> . These parameters being common for all get methods are described in detail in the reference commentary .
limit	integer	
output	query	
preservekeys	boolean	
sortorder	string/array	

Return values

(integer/array) Returns either:

- an array of objects;
- the count of retrieved objects, if the `countOutput` parameter has been used.

Examples

Get a list of nodes ordered by status

Request:

```
{
  "jsonrpc": "2.0",
  "method": "hanode.get",
  "params": {
    "preservekeys": true,
```

```
    "sortfield": "status",
    "sortorder": "DESC"
  },
  "id": 1
}
```

Response:

```
{
  "jsonrpc": "2.0",
  "result": {
    "ckuo7i1nw000h0sajj3l3hh8u": {
      "ha_nodeid": "ckuo7i1nw000h0sajj3l3hh8u",
      "name": "node-active",
      "address": "192.168.1.13",
      "port": "10051",
      "lastaccess": "1635335704",
      "status": "3"
    },
    "ckuo7i1nw000e0sajwfttc1mp": {
      "ha_nodeid": "ckuo7i1nw000e0sajwfttc1mp",
      "name": "node6",
      "address": "192.168.1.10",
      "port": "10053",
      "lastaccess": "1635332902",
      "status": "2"
    },
    "ckuo7i1nv000c0sajz85xcrtt": {
      "ha_nodeid": "ckuo7i1nv000c0sajz85xcrtt",
      "name": "node4",
      "address": "192.168.1.8",
      "port": "10052",
      "lastaccess": "1635334214",
      "status": "1"
    },
    "ckuo7i1nv000a0saj1fcdkeu4": {
      "ha_nodeid": "ckuo7i1nv000a0saj1fcdkeu4",
      "name": "node2",
      "address": "192.168.1.6",
      "port": "10051",
      "lastaccess": "1635335705",
      "status": "0"
    }
  },
  "id": 1
}
```

Get a list of specific nodes by their IDs

Request:

```
{
  "jsonrpc": "2.0",
  "method": "hanode.get",
  "params": {
    "ha_nodeids": ["ckuo7i1nw000e0sajwfttc1mp", "ckuo7i1nv000c0sajz85xcrtt"]
  },
  "id": 1
}
```

Response:

```
{
  "jsonrpc": "2.0",
  "result": [
    {
```

```

    "ha_nodeid": "ckuo7i1nv000c0sajz85xcrtt",
    "name": "node4",
    "address": "192.168.1.8",
    "port": "10052",
    "lastaccess": "1635334214",
    "status": "1"
  },
  {
    "ha_nodeid": "ckuo7i1nw000e0sajwfttc1mp",
    "name": "node6",
    "address": "192.168.1.10",
    "port": "10053",
    "lastaccess": "1635332902",
    "status": "2"
  }
],
"id": 1
}

```

Get a list of stopped nodes

Request:

```

{
  "jsonrpc": "2.0",
  "method": "hanode.get",
  "params": {
    "output": ["ha_nodeid", "address", "port"],
    "filter": {
      "status": 1
    }
  },
  "id": 1
}

```

Response:

```

{
  "jsonrpc": "2.0",
  "result": [
    {
      "ha_nodeid": "ckuo7i1nw000g0sajjsjre7e3",
      "address": "192.168.1.12",
      "port": "10051"
    },
    {
      "ha_nodeid": "ckuo7i1nv000c0sajz85xcrtt",
      "address": "192.168.1.8",
      "port": "10052"
    },
    {
      "ha_nodeid": "ckuo7i1nv000d0sajd95y1b6x",
      "address": "192.168.1.9",
      "port": "10053"
    }
  ],
  "id": 1
}

```

Get a count of standby nodes

Request:

```

{
  "jsonrpc": "2.0",
  "method": "hanode.get",

```

```
"params": {
  "countOutput": true,
  "filter": {
    "status": 0
  }
},
"id": 1
}
```

Response:

```
{
  "jsonrpc": "2.0",
  "result": "3",
  "id": 1
}
```

Check status of nodes at specific IP addresses

Request:

```
{
  "jsonrpc": "2.0",
  "method": "hanode.get",
  "params": {
    "output": ["name", "status"],
    "filter": {
      "address": ["192.168.1.7", "192.168.1.13"]
    }
  },
  "id": 1
}
```

Response:

```
{
  "jsonrpc": "2.0",
  "result": [
    {
      "name": "node3",
      "status": "0"
    },
    {
      "name": "node-active",
      "status": "3"
    }
  ],
  "id": 1
}
```

Source

CHaNode::get() in *ui/include/classes/api/services/CHaNode.php*.

History

This class is designed to work with history data.

Object references:

- [Float history](#)
- [Integer history](#)
- [String history](#)
- [Text history](#)
- [Log history](#)

Available methods:

- `history.clear` - clear history data
- `history.get` - retrieve history data
- `history.push` - send history data to Zabbix server

History object

The following objects are directly related to the `history` API.

Note:

History objects differ depending on the item's type of information. They are created by Zabbix server and cannot be modified via the API.

Float history

The float history object has the following properties.

Property	Type	Description
<code>clock</code>	timestamp	Time when that value was received.
<code>itemid</code>	ID	ID of the related item.
<code>ns</code>	integer	Nanoseconds when the value was received.
<code>value</code>	float	Received value.

Integer history

The integer history object has the following properties.

Property	Type	Description
<code>clock</code>	timestamp	Time when that value was received.
<code>itemid</code>	ID	ID of the related item.
<code>ns</code>	integer	Nanoseconds when the value was received.
<code>value</code>	integer	Received value.

String history

The string history object has the following properties.

Property	Type	Description
<code>clock</code>	timestamp	Time when that value was received.
<code>itemid</code>	ID	ID of the related item.
<code>ns</code>	integer	Nanoseconds when the value was received.
<code>value</code>	string	Received value.

Text history

The text history object has the following properties.

Property	Type	Description
<code>id</code>	ID	ID of the history entry.
<code>clock</code>	timestamp	Time when that value was received.
<code>itemid</code>	ID	ID of the related item.
<code>ns</code>	integer	Nanoseconds when the value was received.
<code>value</code>	text	Received value.

Log history

The log history object has the following properties.

Property	Type	Description
id	ID	ID of the history entry.
clock	timestamp	Time when that value was received.
itemid	ID	ID of the related item.
logeventid	integer	Windows event log entry ID.
ns	integer	Nanoseconds when the value was received.
severity	integer	Windows event log entry level.
source	string	Windows event log entry source.
timestamp	timestamp	Windows event log entry time.
value	text	Received value.

history.clear

Description

object history.clear(array itemids)

This method allows to clear item history.

Note:

This method is only available to *Admin* and *Super admin* user types. Permissions to call the method can be revoked in user role settings. See [User roles](#) for more information.

Parameters

(array) IDs of items to clear.

Return values

(object) Returns an object containing the IDs of the cleared items under the `itemids` property.

Examples

Clear history

Request:

```
{
  "jsonrpc": "2.0",
  "method": "history.clear",
  "params": [
    "10325",
    "13205"
  ],
  "id": 1
}
```

Response:

```
{
  "jsonrpc": "2.0",
  "result": {
    "itemids": [
      "10325",
      "13205"
    ]
  },
  "id": 1
}
```

Source

CHistory::clear() in `ui/include/classes/api/services/CHistory.php`.

history.get

Description

`integer/array history.get(object parameters)`

The method allows to retrieve history data according to the given parameters.

Attention:

This method may return historical data of a deleted entity if this data has not been removed by the housekeeper yet.

Note:

This method is available to users of any type. Permissions to call the method can be revoked in user role settings. See [User roles](#) for more information.

Parameters

(object) Parameters defining the desired output.

The method supports the following parameters.

Parameter	Type	Description
history	integer	History object types to return. Possible values: 0 - numeric float; 1 - character; 2 - log; 3 - <i>(default)</i> numeric unsigned; 4 - text; 5 - binary.
hostids	ID/array	Return only history from the given hosts.
itemids	ID/array	Return only history from the given items.
time_from	timestamp	Return only values that have been received after or at the given time.
time_till	timestamp	Return only values that have been received before or at the given time.
sortfield	string/array	Sort the result by the given properties. Possible values: <code>itemid</code> , <code>clock</code> , <code>ns</code> .
countOutput	boolean	These parameters being common for all <code>get</code> methods are described in detail in the reference commentary page.
editable	boolean	
excludeSearch	boolean	
filter	object	
limit	integer	
output	query	
search	object	
searchByAny	boolean	
searchWildcardsEnabled	boolean	
sortorder	string/array	
startSearch	boolean	

Return values

(integer/array) Returns either:

- an array of objects;
- the count of retrieved objects, if the `countOutput` parameter has been used.

Examples

Retrieving item history data

Return 10 latest values received from a numeric(float) item.

Request:

```
{  
  "jsonrpc": "2.0",
```

```
"method": "history.get",
"params": {
  "output": "extend",
  "history": 0,
  "itemids": "23296",
  "sortfield": "clock",
  "sortorder": "DESC",
  "limit": 10
},
"id": 1
}
```

Response:

```
{
  "jsonrpc": "2.0",
  "result": [
    {
      "itemid": "23296",
      "clock": "1351090996",
      "value": "0.085",
      "ns": "563157632"
    },
    {
      "itemid": "23296",
      "clock": "1351090936",
      "value": "0.16",
      "ns": "549216402"
    },
    {
      "itemid": "23296",
      "clock": "1351090876",
      "value": "0.18",
      "ns": "537418114"
    },
    {
      "itemid": "23296",
      "clock": "1351090816",
      "value": "0.21",
      "ns": "522659528"
    },
    {
      "itemid": "23296",
      "clock": "1351090756",
      "value": "0.215",
      "ns": "507809457"
    },
    {
      "itemid": "23296",
      "clock": "1351090696",
      "value": "0.255",
      "ns": "495509699"
    },
    {
      "itemid": "23296",
      "clock": "1351090636",
      "value": "0.36",
      "ns": "477708209"
    },
    {
      "itemid": "23296",
      "clock": "1351090576",
      "value": "0.375",

```



```

        "ns": "463251343"
    },
    {
        "itemid": "23296",
        "clock": "1351090516",
        "value": "0.315",
        "ns": "447947017"
    },
    {
        "itemid": "23296",
        "clock": "1351090456",
        "value": "0.275",
        "ns": "435307141"
    }
],
"id": 1
}

```

Source

CHistory::get() in `ui/include/classes/api/services/CHistory.php`.

history.push

Description

object history.push(object/array itemHistoryData)

This method allows sending item history data to Zabbix server.

Note:

This method is available to users of any type. Permissions to call the method can be revoked in user role settings. See [User roles](#) for more information.

Parameters

(object/array) Item history data to send.

The method supports the following parameters.

Parameter	Type	Description
itemid	ID	ID of the related item.
host	string	<p>Parameter behavior:</p> <p>- <i>required</i> if host and key are not set</p> <p>Technical name of the host.</p>
key	string	<p>Parameter behavior:</p> <p>- <i>required</i> if itemid is not set</p> <p>Item key.</p>
value	mixed	<p>Parameter behavior:</p> <p>- <i>required</i> if itemid is not set</p> <p>Item value.</p>
clock	timestamp	<p>Parameter behavior:</p> <p>- <i>required</i></p> <p>Time when the value was received.</p>
ns	integer	Nanoseconds when the value was received.

Return values

(object) Returns the result of the data sending operation.

Examples

Send item history data

Send item history data to Zabbix server for items "10600", "10601", and "999999".

Request:

```
{
  "jsonrpc": "2.0",
  "method": "history.push",
  "params": [
    {
      "itemid": 10600,
      "value": 0.5,
      "clock": 1690891294,
      "ns": 45440940
    },
    {
      "itemid": 10600,
      "value": 0.6,
      "clock": 1690891295,
      "ns": 312431
    },
    {
      "itemid": 10601,
      "value": "[Tue Aug 01 15:01:35 2023] [error] [client 1.2.3.4] File does not exist: /var/www/ht
    },
    {
      "itemid": 999999,
      "value": 123
    }
  ],
  "id": 1
}
```

Response:

```
{
  "jsonrpc": "2.0",
  "result": {
    "response": "success",
    "data": [
      {
        "itemid": "10600"
      },
      {
        "itemid": "10600"
      },
      {
        "itemid": "10601",
        "error": "Item is disabled."
      },
      {
        "error": "No permissions to referred object or it does not exist."
      }
    ]
  },
  "id": 1
}
```

See also

- [Trapper items](#)
- [HTTP agent items](#)
- [Host](#)
- [Item](#)

Source

CHistory::push() in *ui/include/classes/api/services/CHistory.php*.

Host

This class is designed to work with hosts.

Object references:

- [Host](#)
- [Host inventory](#)
- [Host tag](#)

Available methods:

- [host.create](#) - create new hosts
- [host.delete](#) - delete hosts
- [host.get](#) - retrieve hosts
- [host.massadd](#) - add related objects to hosts
- [host.massremove](#) - remove related objects from hosts
- [host.massupdate](#) - replace or remove related objects from hosts
- [host.update](#) - update hosts

Host object

The following objects are directly related to the host API.

Host

The host object has the following properties.

Property	Type	Description
hostid	ID	ID of the host. Property behavior: - <i>read-only</i>
host	string	- <i>required</i> for update operations Technical name of the host. Property behavior: - <i>required</i> for create operations
description	text	Description of the host.
flags	integer	Origin of the host. Possible values: 0 - a plain host; 4 - a discovered host.
inventory_mode	integer	Property behavior: - <i>read-only</i> Host inventory population mode. Possible values: -1 - (<i>default</i>) disabled; 0 - manual; 1 - automatic.

Property	Type	Description
ipmi_authtype	integer	IPMI authentication algorithm. Possible values: -1 - <i>(default)</i> default; 0 - none; 1 - MD2; 2 - MD5 4 - straight; 5 - OEM; 6 - RMCP+.
ipmi_password	string	IPMI password.
ipmi_privilege	integer	IPMI privilege level. Possible values: 1 - callback; 2 - <i>(default)</i> user; 3 - operator; 4 - admin; 5 - OEM.
ipmi_username	string	IPMI username.
maintenance_from	timestamp	Starting time of the effective maintenance.
maintenance_status	integer	Property behavior: - <i>read-only</i> Effective maintenance status. Possible values: 0 - <i>(default)</i> no maintenance; 1 - maintenance in effect.
maintenance_type	integer	Property behavior: - <i>read-only</i> Effective maintenance type. Possible values: 0 - <i>(default)</i> maintenance with data collection; 1 - maintenance without data collection.
maintenanceid	ID	Property behavior: - <i>read-only</i> ID of the maintenance that is currently in effect on the host.
name	string	Property behavior: - <i>read-only</i> Visible name of the host.
monitored_by	integer	Default: host property value. Source that is used to monitor the host. Possible values: 0 - <i>(default)</i> Zabbix server; 1 - Proxy; 2 - Proxy group.
proxyid	ID	ID of the proxy that is used to monitor the host.
proxy_groupid	ID	Property behavior: - <i>required</i> if monitored_by is set to "Proxy" ID of the proxy group that is used to monitor the host. Property behavior: - <i>required</i> if monitored_by is set to "Proxy group"

Property	Type	Description
status	integer	Status and function of the host. Possible values: 0 - (<i>default</i>) monitored host; 1 - unmonitored host.
tls_connect	integer	Connections to host. Possible values: 1 - (<i>default</i>) No encryption; 2 - PSK; 4 - certificate.
tls_accept	integer	Connections from host. Possible bitmap values: 1 - (<i>default</i>) No encryption; 2 - PSK; 4 - certificate. This is a bitmask field; any sum of possible bitmap values is acceptable (for example, 6 for PSK and certificate).
tls_issuer	string	Certificate issuer.
tls_subject	string	Certificate subject.
tls_psk_identity	string	PSK identity; must be paired with only one PSK (across autoregistration , hosts , and proxies). Do not include sensitive information in the PSK identity, as it is sent unencrypted over the network to inform the receiver which PSK to use. Property behavior: - <i>write-only</i> - <i>required</i> if <code>tls_connect</code> is set to "PSK", or <code>tls_accept</code> contains the "PSK" bit
tls_psk	string	Pre-shared key (PSK); must be at least 32 hex digits. Property behavior: - <i>write-only</i> - <i>required</i> if <code>tls_connect</code> is set to "PSK", or <code>tls_accept</code> contains the "PSK" bit
active_available	integer	Host active interface availability status. Possible values: 0 - interface status is unknown; 1 - interface is available; 2 - interface is not available. Property behavior: - <i>read-only</i>
assigned_proxymid	ID	ID of the proxy assigned by Zabbix server, if the host is monitored by a proxy group. Property behavior: - <i>read-only</i>

Host inventory

The host inventory object has the following properties.

Note:

Each property has its own unique ID number, which is used to associate host inventory fields with items.

ID	Property	Type	Description	Maximum length
4	alias	string	Alias.	128 characters
11	asset_tag	string	Asset tag.	64 characters
28	chassis	string	Chassis.	64 characters
23	contact	string	Contact person.	65535 characters for SQL databases
32	contract_number	string	Contract number.	64 characters
47	date_hw_decomm	string	HW decommissioning date.	64 characters
46	date_hw_expiry	string	HW maintenance expiry date.	64 characters
45	date_hw_install	string	HW installation date.	64 characters
44	date_hw_purchase	string	HW purchase date.	64 characters
34	deployment_status	string	Deployment status.	64 characters
14	hardware	string	Hardware.	255 characters
15	hardware_full	string	Detailed hardware.	65535 characters for SQL databases
39	host_netmask	string	Host subnet mask.	39 characters
38	host_networks	string	Host networks.	65535 characters for SQL databases
40	host_router	string	Host router.	39 characters
30	hw_arch	string	HW architecture.	32 characters
33	installer_name	string	Installer name.	64 characters
24	location	string	Location.	65535 characters for SQL databases
25	location_lat	string	Location latitude.	16 characters
26	location_lon	string	Location longitude.	16 characters
12	macaddress_a	string	MAC address A.	64 characters
13	macaddress_b	string	MAC address B.	64 characters
29	model	string	Model.	64 characters
3	name	string	Name.	128 characters
27	notes	string	Notes.	65535 characters for SQL databases
41	oob_ip	string	OOB IP address.	39 characters
42	oob_netmask	string	OOB host subnet mask.	39 characters
43	oob_router	string	OOB router.	39 characters
5	os	string	OS name.	128 characters
6	os_full	string	Detailed OS name.	255 characters
7	os_short	string	Short OS name.	128 characters
61	poc_1_cell	string	Primary POC mobile number.	64 characters
58	poc_1_email	string	Primary email.	128 characters
57	poc_1_name	string	Primary POC name.	128 characters
63	poc_1_notes	string	Primary POC notes.	65535 characters for SQL databases
59	poc_1_phone_a	string	Primary POC phone A.	64 characters
60	poc_1_phone_b	string	Primary POC phone B.	64 characters
62	poc_1_screen	string	Primary POC screen name.	64 characters
68	poc_2_cell	string	Secondary POC mobile number.	64 characters
65	poc_2_email	string	Secondary POC email.	128 characters
64	poc_2_name	string	Secondary POC name.	128 characters
70	poc_2_notes	string	Secondary POC notes.	65535 characters for SQL databases
66	poc_2_phone_a	string	Secondary POC phone A.	64 characters
67	poc_2_phone_b	string	Secondary POC phone B.	64 characters
69	poc_2_screen	string	Secondary POC screen name.	64 characters
8	serialno_a	string	Serial number A.	64 characters
9	serialno_b	string	Serial number B.	64 characters
48	site_address_a	string	Site address A.	128 characters
49	site_address_b	string	Site address B.	128 characters
50	site_address_c	string	Site address C.	128 characters
51	site_city	string	Site city.	128 characters
53	site_country	string	Site country.	64 characters
56	site_notes	string	Site notes.	65535 characters for SQL databases
55	site_rack	string	Site rack location.	128 characters
52	site_state	string	Site state.	64 characters
54	site_zip	string	Site ZIP/postal code.	64 characters
16	software	string	Software.	255 characters
18	software_app_a	string	Software application A.	64 characters
19	software_app_b	string	Software application B.	64 characters
20	software_app_c	string	Software application C.	64 characters
21	software_app_d	string	Software application D.	64 characters

ID	Property	Type	Description	Maximum length
22	software_app_e	string	Software application E.	64 characters
17	software_full	string	Software details.	65535 characters for SQL databases
10	tag	string	Tag.	64 characters
1	type	string	Type.	64 characters
2	type_full	string	Type details.	64 characters
35	url_a	string	URL A.	2048 characters
36	url_b	string	URL B.	2048 characters
37	url_c	string	URL C.	2048 characters
31	vendor	string	Vendor.	64 characters

Host tag

The host tag object has the following properties.

Property	Type	Description
tag	string	Host tag name.
value	string	Host tag value.
automatic	integer	Type of host tag.

Property behavior:
- *required*

Possible values:
0 - (*default*) manual (tag created by user);
1 - automatic (tag created by low-level discovery)

host.create

Description

object `host.create(object/array hosts)`

This method allows to create new hosts.

Note:

This method is only available to *Admin* and *Super admin* user types. Permissions to call the method can be revoked in user role settings. See [User roles](#) for more information.

Parameters

(object/array) Hosts to create.

Additionally to the [standard host properties](#), the method accepts the following parameters.

Parameter	Type	Description
groups	object/array	Host groups to add the host to. The host groups must have only the <code>groupid</code> property defined.
interfaces	object/array	Interfaces to be created for the host.
tags	object/array	Host tags .
templates	object/array	Templates to be linked to the host. The templates must have only the <code>templateid</code> property defined.
macros	object/array	User macros to be created for the host.
inventory	object	Host inventory properties.

Return values

(object) Returns an object containing the IDs of the created hosts under the `host_ids` property. The order of the returned IDs matches the order of the passed hosts.

Examples

Creating a host

Create a host called "Linux server" with an IP interface and tags, add it to a group, link a template to it and set the MAC addresses in the host inventory.

Request:

```
{
  "jsonrpc": "2.0",
  "method": "host.create",
  "params": {
    "host": "Linux server",
    "interfaces": [
      {
        "type": 1,
        "main": 1,
        "useip": 1,
        "ip": "192.168.3.1",
        "dns": "",
        "port": "10050"
      }
    ],
    "groups": [
      {
        "groupid": "50"
      }
    ],
    "tags": [
      {
        "tag": "host-name",
        "value": "linux-server"
      }
    ],
    "templates": [
      {
        "templateid": "20045"
      }
    ],
    "macros": [
      {
        "macro": "${USER_ID}",
        "value": "123321"
      },
      {
        "macro": "${USER_LOCATION}",
        "value": "0:0:0",
        "description": "latitude, longitude and altitude coordinates"
      }
    ],
    "inventory_mode": 0,
    "inventory": {
      "macaddress_a": "01234",
      "macaddress_b": "56768"
    }
  },
  "id": 1
}
```

Response:

```

{
  "jsonrpc": "2.0",
  "result": {
    "hostids": [
      "107819"
    ]
  },
  "id": 1
}

```

Creating a host with SNMP interface

Create a host called "SNMP host" with an SNMPv3 interface with details.

Request:

```

{
  "jsonrpc": "2.0",
  "method": "host.create",
  "params": {
    "host": "SNMP host",
    "interfaces": [
      {
        "type": 2,
        "main": 1,
        "useip": 1,
        "ip": "127.0.0.1",
        "dns": "",
        "port": "161",
        "details": {
          "version": 3,
          "bulk": 0,
          "securityname": "mysecurityname",
          "contextname": "",
          "securitylevel": 1
        }
      }
    ],
    "groups": [
      {
        "groupid": "4"
      }
    ]
  },
  "id": 1
}

```

Response:

```

{
  "jsonrpc": "2.0",
  "result": {
    "hostids": [
      "10658"
    ]
  },
  "id": 1
}

```

Creating a host with PSK encryption

Create a host called "PSK host" with PSK encryption configured. Note that the host has to be **pre-configured to use PSK**.

Request:

```

{
  "jsonrpc": "2.0",

```

```

"method": "host.create",
"params": {
  "host": "PSK host",
  "interfaces": [
    {
      "type": 1,
      "ip": "192.168.3.1",
      "dns": "",
      "port": "10050",
      "useip": 1,
      "main": 1
    }
  ],
  "groups": [
    {
      "groupid": "2"
    }
  ],
  "tls_accept": 2,
  "tls_connect": 2,
  "tls_psk_identity": "PSK 001",
  "tls_psk": "1f87b595725ac58dd977beef14b97461a7c1045b9a1c963065002c5473194952"
},
"id": 1
}

```

Response:

```

{
  "jsonrpc": "2.0",
  "result": {
    "hostids": [
      "10590"
    ]
  },
  "id": 1
}

```

Creating a host monitored by a proxy

Create a host that will be monitored by proxy with ID "1".

Request:

```

{
  "jsonrpc": "2.0",
  "method": "host.create",
  "params": {
    "host": "Host monitored by proxy",
    "groups": [
      {
        "groupid": "2"
      }
    ],
    "monitored_by": 1,
    "proxyid": 1
  },
  "id": 1
}

```

Response:

```

{
  "jsonrpc": "2.0",
  "result": {
    "hostids": [

```

```
        "10591"  
    ],  
  },  
  "id": 1  
}
```

Creating a host monitored by a proxy group

Create a host that will be monitored by proxy group with ID "1".

Request:

```
{  
  "jsonrpc": "2.0",  
  "method": "host.create",  
  "params": {  
    "host": "Host monitored by proxy group",  
    "groups": [  
      {  
        "groupid": "2"  
      }  
    ],  
    "monitored_by": 2,  
    "proxy_groupid": 1  
  },  
  "id": 1  
}
```

Response:

```
{  
  "jsonrpc": "2.0",  
  "result": {  
    "hostids": [  
      "10592"  
    ]  
  },  
  "id": 1  
}
```

See also

- [Host group](#)
- [Template](#)
- [User macro](#)
- [Host interface](#)
- [Host inventory](#)
- [Host tag](#)
- [Proxy](#)
- [Proxy group](#)

Source

`CHost::create()` in `ui/include/classes/api/services/CHost.php`.

host.delete

Description

`object host.delete(array hosts)`

This method allows to delete hosts.

Note:

This method is only available to *Admin* and *Super admin* user types. Permissions to call the method can be revoked in user role settings. See [User roles](#) for more information.

Parameters

(array) IDs of hosts to delete.

Return values

(object) Returns an object containing the IDs of the deleted hosts under the `hostids` property.

Examples

Deleting multiple hosts

Delete two hosts.

Request:

```
{
  "jsonrpc": "2.0",
  "method": "host.delete",
  "params": [
    "13",
    "32"
  ],
  "id": 1
}
```

Response:

```
{
  "jsonrpc": "2.0",
  "result": {
    "hostids": [
      "13",
      "32"
    ]
  },
  "id": 1
}
```

Source

`CHost::delete()` in `ui/include/classes/api/services/CHost.php`.

host.get

Description

integer/array `host.get(object parameters)`

The method allows to retrieve hosts according to the given parameters.

Note:

This method is available to users of any type. Permissions to call the method can be revoked in user role settings. See [User roles](#) for more information.

Parameters

(object) Parameters defining the desired output.

The method supports the following parameters.

Parameter	Type	Description
<code>groupids</code>	ID/array	Return only hosts that belong to the given groups.
<code>dserviceids</code>	ID/array	Return only hosts that are related to the given discovered services.
<code>graphids</code>	ID/array	Return only hosts that have the given graphs.
<code>hostids</code>	ID/array	Return only hosts with the given host IDs.
<code>httpstestsids</code>	ID/array	Return only hosts that have the given web checks.
<code>interfaceids</code>	ID/array	Return only hosts that use the given interfaces.
<code>itemids</code>	ID/array	Return only hosts that have the given items.

Parameter	Type	Description
maintenanceids	ID/array	Return only hosts that are affected by the given maintenances.
monitored_hosts	flag	Return only monitored hosts.
proxyids	ID/array	Return only hosts that are monitored by the given proxies.
proxy_groupids	ID/array	Return only hosts that are monitored by the given proxy groups.
templated_hosts	flag	Return both hosts and templates.
templateids	ID/array	Return only hosts that are linked to the given templates.
triggerids	ID/array	Return only hosts that have the given triggers.
with_items	flag	Return only hosts that have items.
with_item_prototypes	flag	Overrides the <code>with_monitored_items</code> and <code>with_simple_graph_items</code> parameters. Return only hosts that have item prototypes.
with_simple_graph_item_prototypes	flag	Overrides the <code>with_simple_graph_item_prototypes</code> parameter. Return only hosts that have item prototypes, which are enabled for creation and have numeric type of information.
with_graphs	flag	Return only hosts that have graphs.
with_graph_prototypes	flag	Return only hosts that have graph prototypes.
with_httptests	flag	Return only hosts that have web checks.
with_monitored_httptests	flag	Overrides the <code>with_monitored_httptests</code> parameter. Return only hosts that have enabled web checks.
with_monitored_items	flag	Return only hosts that have enabled items.
with_monitored_triggers	flag	Overrides the <code>with_simple_graph_items</code> parameter. Return only hosts that have enabled triggers. All of the items used in the trigger must also be enabled.
with_simple_graph_items	flag	Return only hosts that have items with numeric type of information.
with_triggers	flag	Return only hosts that have triggers.
withProblemsSuppressed	boolean	Overrides the <code>with_monitored_triggers</code> parameter. Return hosts that have suppressed problems. Possible values: <code>null</code> - (default) all hosts; <code>true</code> - only hosts with suppressed problems; <code>false</code> - only hosts with unsuppressed problems.
evaltype	integer	Rules for tag searching. Possible values: <code>0</code> - (default) And/Or; <code>2</code> - Or.
severities	integer/array	Return hosts that have only problems with given severities. Applies only if problem object is trigger.
tags	object/array	Return only hosts with given tags. Exact match by tag and case-sensitive or case-insensitive search by tag value depending on operator value. Format: [{"tag": "<tag>", "value": "<value>", "operator": "<operator>"}, ...]. An empty array returns all hosts. Possible operator values: <code>0</code> - (default) Contains; <code>1</code> - Equals; <code>2</code> - Not like; <code>3</code> - Not equal; <code>4</code> - Exists; <code>5</code> - Not exists.

Parameter	Type	Description
inheritedTags	boolean	Return hosts that have given tags also in all of their linked templates. Default: Possible values: true - linked templates must also have given tags; false - (default) linked template tags are ignored.
selectDiscoveries	query	Return a discoveries property with host low-level discovery rules. Supports count.
selectDiscoveryRule	query	Return a discoveryRule property with the low-level discovery rule that created the host (from host prototype in VMware monitoring).
selectGraphs	query	Return a graphs property with host graphs. Supports count.
selectHostDiscovery	query	Return a hostDiscovery property with host discovery object data. The host discovery object links a discovered host to a host prototype or a host prototypes to an LLD rule and has the following properties: host - (string) host of the host prototype; hostid - (string) ID of the discovered host or host prototype; parent_hostid - (string) ID of the host prototype from which the host has been created; parent_itemid - (string) ID of the LLD rule that created the discovered host; lastcheck - (timestamp) time when the host was last discovered; status - (int) host discovery status: 0 - (default) host is discovered, 1 - host is not discovered anymore; ts_delete - (timestamp) time when a host that is no longer discovered will be deleted; ts_disable - (timestamp) time when a host that is no longer discovered will be disabled; disable_source - (int) indicator of whether host was disabled by an LLD rule or manually: 0 - (default) disabled automatically, 1 - disabled by an LLD rule.
selectHostGroups	query	Return a hostgroups property with host groups data that the host belongs to.
selectHttpTests	query	Return an httpTests property with host web scenarios. Supports count.
selectInterfaces	query	Return an interfaces property with host interfaces. Supports count.
selectInventory	query	Return an inventory property with host inventory data.
selectItems	query	Return an items property with host items. Supports count.
selectMacros	query	Return a macros property with host macros.
selectParentTemplates	query	Return a parentTemplates property with templates that the host is linked to. In addition to Template object fields, it contains link_type - (integer) the way that the template is linked to host. Possible values: 0 - (default) manually linked; 1 - automatically linked by LLD.
selectDashboards	query	Supports count. Return a dashboards property. Supports count.

Parameter	Type	Description
selectTags	query	Return a tags property with host tags.
selectInheritedTags	query	Return an inheritedTags property with tags that are on all templates which are linked to host.
selectTriggers	query	Return a triggers property with host triggers.
selectValueMaps	query	Supports count. Return a valuemaps property with host value maps.
filter	object	Return only those results that exactly match the given filter. Accepts an object, where the keys are property names, and the values are either a single value or an array of values to match against. Does not support properties of text data type .
limitSelects	integer	Supports additional properties: Host interface properties. Limits the number of records returned by subselects. Applies to the following subselects: selectParentTemplates - results will be sorted by host; selectInterfaces; selectItems - sorted by name; selectDiscoveries - sorted by name; selectTriggers - sorted by description; selectGraphs - sorted by name; selectDashboards - sorted by name.
search	object	Return results that match the given pattern (case-insensitive). Accepts an object, where the keys are property names, and the values are strings to search for. If no additional options are given, this will perform a LIKE "%...%" search. Supports only properties of string and text data type .
searchInventory	object	Supports additional properties: Host interface properties. Return hosts that have inventory data that match the given pattern (case-insensitive). Accepts an object, where the keys are property names, and the values are strings to search for. If no additional options are given, this will perform a LIKE "%...%" search. Supports only properties of string and text data type .
sortfield	string/array	Supports only properties of string and text data type . Sort the result by the given properties.
countOutput	boolean	Possible values: <code>hostid</code> , <code>host</code> , <code>name</code> , <code>status</code> . These parameters being common for all get methods are described in detail in the reference commentary .
editable	boolean	
excludeSearch	boolean	
limit	integer	
output	query	
preservekeys	boolean	
searchByAny	boolean	
searchWildcardsEnabled	boolean	
sortorder	string/array	
startSearch	boolean	

Return values

(integer/array) Returns either:

- an array of objects;

- the count of retrieved objects, if the countOutput parameter has been used.

Examples

Retrieving data by name

Retrieve all data about two hosts named "Zabbix server" and "Linux server".

Request:

```
{
  "jsonrpc": "2.0",
  "method": "host.get",
  "params": {
    "filter": {
      "host": [
        "Zabbix server",
        "Linux server"
      ]
    }
  },
  "id": 1
}
```

Response:

```
{
  "jsonrpc": "2.0",
  "result": [
    {
      "hostid": "10160",
      "proxyid": "0",
      "host": "Zabbix server",
      "status": "0",
      "ipmi_authtype": "-1",
      "ipmi_privilege": "2",
      "ipmi_username": "",
      "ipmi_password": "",
      "maintenanceid": "0",
      "maintenance_status": "0",
      "maintenance_type": "0",
      "maintenance_from": "0",
      "name": "Zabbix server",
      "flags": "0",
      "description": "The Zabbix monitoring server.",
      "tls_connect": "1",
      "tls_accept": "1",
      "tls_issuer": "",
      "tls_subject": "",
      "proxy_groupid": "0",
      "monitored_by": "0",
      "inventory_mode": "1",
      "active_available": "1",
      "assigned_proxyid": "0"
    },
    {
      "hostid": "10167",
      "proxyid": "0",
      "host": "Linux server",
      "status": "0",
      "ipmi_authtype": "-1",
      "ipmi_privilege": "2",
      "ipmi_username": "",
      "ipmi_password": "",
      "maintenanceid": "0",
      "maintenance_status": "0",

```



```

        "maintenance_type": "0",
        "maintenance_from": "0",
        "name": "Linux server",
        "flags": "0",
        "description": "",
        "tls_connect": "1",
        "tls_accept": "1",
        "tls_issuer": "",
        "tls_subject": "",
        "proxy_groupid": "0",
        "monitored_by": "0",
        "inventory_mode": "1",
        "active_available": "1",
        "assigned_proxyid": "0"
    }
],
    "id": 1
}

```

Retrieving host groups

Retrieve host groups that the host "Zabbix server" is a member of.

Request:

```

{
    "jsonrpc": "2.0",
    "method": "host.get",
    "params": {
        "output": ["hostid"],
        "selectHostGroups": "extend",
        "filter": {
            "host": [
                "Zabbix server"
            ]
        }
    }
},
    "id": 1
}

```

Response:

```

{
    "jsonrpc": "2.0",
    "result": [
        {
            "hostid": "10085",
            "hostgroups": [
                {
                    "groupid": "2",
                    "name": "Linux servers",
                    "flags": "0",
                    "uuid": "dc579cd7a1a34222933f24f52a68bcd8"
                },
                {
                    "groupid": "4",
                    "name": "Zabbix servers",
                    "flags": "0",
                    "uuid": "6f6799aa69e844b4b3918f779f2abf08"
                }
            ]
        }
    ],
    "id": 1
}

```

Retrieving linked templates

Retrieve the IDs and names of templates linked to host "10084".

Request:

```
{
  "jsonrpc": "2.0",
  "method": "host.get",
  "params": {
    "output": ["hostid"],
    "selectParentTemplates": [
      "templateid",
      "name"
    ],
    "hostids": "10084"
  },
  "id": 1
}
```

Response:

```
{
  "jsonrpc": "2.0",
  "result": [
    {
      "hostid": "10084",
      "parentTemplates": [
        {
          "name": "Linux",
          "templateid": "10001"
        },
        {
          "name": "Zabbix Server",
          "templateid": "10047"
        }
      ]
    }
  ],
  "id": 1
}
```

Retrieving hosts by template

Retrieve hosts that have the "10001" (*Linux by Zabbix agent*) template linked to them.

Request:

```
{
  "jsonrpc": "2.0",
  "method": "host.get",
  "params": {
    "output": ["hostid", "name"],
    "templateids": "10001"
  },
  "id": 1
}
```

Response:

```
{
  "jsonrpc": "2.0",
  "result": [
    {
      "templateid": "10001",
      "hosts": [
        {
          "hostid": "10084",

```

```

        "name": "Zabbix server"
    },
    {
        "hostid": "10603",
        "name": "Host 1"
    },
    {
        "hostid": "10604",
        "name": "Host 2"
    }
]
}
],
"id": 1
}

```

Searching by host inventory data

Retrieve hosts that contain "Linux" in the host inventory "OS" field.

Request:

```

{
  "jsonrpc": "2.0",
  "method": "host.get",
  "params": {
    "output": [
      "host"
    ],
    "selectInventory": [
      "os"
    ],
    "searchInventory": {
      "os": "Linux"
    }
  },
  "id": 1
}

```

Response:

```

{
  "jsonrpc": "2.0",
  "result": [
    {
      "hostid": "10084",
      "host": "Zabbix server",
      "inventory": {
        "os": "Linux Ubuntu"
      }
    },
    {
      "hostid": "10107",
      "host": "Linux server",
      "inventory": {
        "os": "Linux Mint"
      }
    }
  ],
  "id": 1
}

```

Searching by host tags

Retrieve hosts that have tag "host-name" equal to "linux-server".

Request:

```

{
  "jsonrpc": "2.0",
  "method": "host.get",
  "params": {
    "output": ["hostid"],
    "selectTags": "extend",
    "evaltype": 0,
    "tags": [
      {
        "tag": "host-name",
        "value": "linux-server",
        "operator": 1
      }
    ]
  },
  "id": 1
}

```

Response:

```

{
  "jsonrpc": "2.0",
  "result": [
    {
      "hostid": "10085",
      "tags": [
        {
          "tag": "host-name",
          "value": "linux-server"
        },
        {
          "tag": "os",
          "value": "rhel-7"
        }
      ]
    }
  ],
  "id": 1
}

```

Retrieve hosts that have these tags not only on host level but also in their linked parent templates.

Request:

```

{
  "jsonrpc": "2.0",
  "method": "host.get",
  "params": {
    "output": ["name"],
    "tags": [
      {
        "tag": "os",
        "value": "rhel-7",
        "operator": 1
      }
    ],
    "inheritedTags": true
  },
  "id": 1
}

```

Response:

```

{
  "jsonrpc": "2.0",

```

```

"result": [
  {
    "hostid": "10623",
    "name": "PC room 1"
  },
  {
    "hostid": "10601",
    "name": "Office"
  }
],
"id": 1
}

```

Searching host with tags and template tags

Retrieve a host with tags and all tags that are linked to parent templates.

Request:

```

{
  "jsonrpc": "2.0",
  "method": "host.get",
  "params": {
    "output": ["name"],
    "hostids": 10502,
    "selectTags": ["tag", "value"],
    "selectInheritedTags": ["tag", "value"]
  },
  "id": 1
}

```

Response:

```

{
  "jsonrpc": "2.0",
  "result": [
    {
      "hostid": "10502",
      "name": "Desktop",
      "tags": [
        {
          "tag": "host-name",
          "value": "linux-server"
        },
        {
          "tag": "os",
          "value": "rhel-7"
        }
      ],
      "inheritedTags": [
        {
          "tag": "class",
          "value": "os"
        },
        {
          "tag": "target",
          "value": "linux"
        },
        {
          "tag": "os",
          "value": "rhel-7"
        }
      ]
    }
  ],
  "id": 1
}

```

```
"id": 1
}
```

Searching hosts by problem severity

Retrieve hosts that have "Disaster" problems.

Request:

```
{
  "jsonrpc": "2.0",
  "method": "host.get",
  "params": {
    "output": ["name"],
    "severities": 5
  },
  "id": 1
}
```

Response:

```
{
  "jsonrpc": "2.0",
  "result": [
    {
      "hostid": "10160",
      "name": "Zabbix server"
    }
  ],
  "id": 1
}
```

Retrieve hosts that have "Average" and "High" problems.

Request:

```
{
  "jsonrpc": "2.0",
  "method": "host.get",
  "params": {
    "output": ["name"],
    "severities": [3, 4]
  },
  "id": 1
}
```

Response:

```
{
  "jsonrpc": "2.0",
  "result": [
    {
      "hostid": "20170",
      "name": "Database"
    },
    {
      "hostid": "20183",
      "name": "workstation"
    }
  ],
  "id": 1
}
```

See also

- [Host group](#)
- [Template](#)
- [User macro](#)

- [Host interface](#)
- [Proxy](#)
- [Proxy group](#)

Source

`CHost::get()` in `ui/include/classes/api/services/CHost.php`.

host.massadd

Description

`object host.massadd(object parameters)`

This method allows to simultaneously add multiple related objects to all the given hosts.

Note:

This method is only available to *Admin* and *Super admin* user types. Permissions to call the method can be revoked in user role settings. See [User roles](#) for more information.

Parameters

(object) Parameters containing the IDs of the hosts to update and the objects to add to all the hosts.

The method accepts the following parameters.

Parameter	Type	Description
hosts	object/array	<p>Hosts to be updated.</p> <p>The hosts must have only the <code>hostid</code> property defined.</p> <p>Parameter behavior: - <i>required</i></p>
groups	object/array	<p>Host groups to add to the given hosts.</p> <p>The host groups must have only the <code>groupid</code> property defined.</p>
interfaces	object/array	Host interfaces to be created for the given hosts.
macros	object/array	User macros to be created for the given hosts.
templates	object/array	<p>Templates to link to the given hosts.</p> <p>The templates must have only the <code>templateid</code> property defined.</p>

Return values

(object) Returns an object containing the IDs of the updated hosts under the `hostids` property.

Examples

Adding macros

Add two new macros to two hosts.

Request:

```
{
  "jsonrpc": "2.0",
  "method": "host.massadd",
  "params": {
    "hosts": [
      {
        "hostid": "10160"
      },
      {
        "hostid": "10167"
      }
    ],
    "macros": [
```

```

    {
      "macro": "${TEST1}",
      "value": "MACROTEST1"
    },
    {
      "macro": "${TEST2}",
      "value": "MACROTEST2",
      "description": "Test description"
    }
  ]
},
"id": 1
}

```

Response:

```

{
  "jsonrpc": "2.0",
  "result": {
    "hostids": [
      "10160",
      "10167"
    ]
  },
  "id": 1
}

```

See also

- [host.update](#)
- [Host group](#)
- [Template](#)
- [User macro](#)
- [Host interface](#)

Source

`CHost::massAdd()` in `ui/include/classes/api/services/CHost.php`.

host.massremove

Description

`object host.massremove(object parameters)`

This method allows to remove related objects from multiple hosts.

Note:

This method is only available to *Admin* and *Super admin* user types. Permissions to call the method can be revoked in user role settings. See [User roles](#) for more information.

Parameters

(object) Parameters containing the IDs of the hosts to update and the objects that should be removed.

Parameter	Type	Description
hostids	ID/array	IDs of the hosts to be updated.
groupids	ID/array	IDs of the host groups to remove the given hosts from.
interfaces	object/array	Host interfaces to remove from the given hosts.

The host interface object must have only the `ip`, `dns` and `port` properties defined.

Parameter	Type	Description
macros	string/array	User macros to delete from the given hosts.
templateids	ID/array	IDs of the templates to unlink from the given hosts.
templateids_clear	ID/array	IDs of the templates to unlink and clear from the given hosts.

Return values

(object) Returns an object containing the IDs of the updated hosts under the `hostids` property.

Examples

Unlinking templates

Unlink a template from two hosts and delete all of the templated entities.

Request:

```
{
  "jsonrpc": "2.0",
  "method": "host.massremove",
  "params": {
    "hostids": ["69665", "69666"],
    "templateids_clear": "325"
  },
  "id": 1
}
```

Response:

```
{
  "jsonrpc": "2.0",
  "result": {
    "hostids": [
      "69665",
      "69666"
    ]
  },
  "id": 1
}
```

See also

- [host.update](#)
- [User macro](#)
- [Host interface](#)

Source

`CHost::massRemove()` in `ui/include/classes/api/services/CHost.php`.

host.massupdate

Description

object `host.massupdate(object parameters)`

This method allows to simultaneously replace or remove related objects and update properties on multiple hosts.

Note:

This method is only available to *Admin* and *Super admin* user types. Permissions to call the method can be revoked in user role settings. See [User roles](#) for more information.

Parameters

(object) Parameters containing the IDs of the hosts to update and the properties that should be updated.

Additionally to the [standard host properties](#), the method accepts the following parameters.

Parameter	Type	Description
hosts	object/array	<p>Hosts to be updated.</p> <p>The hosts must have only the <code>hostid</code> property defined.</p> <p>Parameter behavior: - <i>required</i></p>
groups	object/array	<p>Host groups to replace the current host groups the hosts belong to.</p> <p>The host groups must have only the <code>groupid</code> property defined.</p>
interfaces	object/array	<p>Host interfaces to replace the current host interfaces on the given hosts.</p>
inventory	object	<p>Host inventory properties.</p> <p>Host inventory mode cannot be updated using the <code>inventory</code> parameter, use <code>inventory_mode</code> instead.</p>
macros	object/array	<p>User macros to replace the current user macros on the given hosts.</p>
templates	object/array	<p>Templates to replace the currently linked templates on the given hosts.</p> <p>The templates must have only the <code>templateid</code> property defined.</p>
templates_clear	object/array	<p>Templates to unlink and clear from the given hosts.</p> <p>The templates must have only the <code>templateid</code> property defined.</p>

Return values

(object) Returns an object containing the IDs of the updated hosts under the `hostids` property.

Examples

Enabling multiple hosts

Enable monitoring of two hosts, that is, set their status to "0".

Request:

```
{
  "jsonrpc": "2.0",
  "method": "host.massupdate",
  "params": {
    "hosts": [
      {
        "hostid": "69665"
      },
      {
        "hostid": "69666"
      }
    ],
    "status": 0
  },
  "id": 1
}
```

Response:

```
{
  "jsonrpc": "2.0",
  "result": {
    "hostids": [
      "69665",
      "69666"
    ]
  },
  "id": 1
}
```

See also

- [host.update](#)
- [host.massadd](#)
- [host.massremove](#)
- [Host group](#)
- [Template](#)
- [User macro](#)
- [Host interface](#)

Source

`CHost::massUpdate()` in `ui/include/classes/api/services/CHost.php`.

host.update

Description

`object host.update(object/array hosts)`

This method allows to update existing hosts.

Note:

This method is only available to *Admin* and *Super admin* user types. Permissions to call the method can be revoked in user role settings. See [User roles](#) for more information.

Parameters

(object/array) Host properties to be updated.

The `hostid` property must be defined for each host, all other properties are optional. Only the given properties will be updated, all others will remain unchanged.

Note, however, that updating the host technical name will also update the host's visible name (if not given or empty) by the host's technical name value.

Additionally to the [standard host properties](#), the method accepts the following parameters.

Parameter	Type	Description
groups	object/array	Host groups to replace the current host groups the host belongs to. All host groups that are not listed in the request will be unlinked. The host groups must have only the <code>groupid</code> property defined.
interfaces	object/array	Host interfaces to replace the current host interfaces. All interfaces that are not listed in the request will be removed.
tags	object/array	Host tags to replace the current host tags. All tags that are not listed in the request will be removed.
inventory macros	object object/array	Host inventory properties. User macros to replace the current user macros. All macros that are not listed in the request will be removed.
templates	object/array	Templates to replace the currently linked templates. All templates that are not listed in the request will be only unlinked. The templates must have only the <code>templateid</code> property defined.
templates_clear	object/array	Templates to unlink and clear from the host. The templates must have only the <code>templateid</code> property defined.

Note:

As opposed to the Zabbix frontend, when `name` (visible host name) is the same as `host` (technical host name), updating `host` via API will not automatically update `name`. Both properties need to be updated explicitly.

Return values

(object) Returns an object containing the IDs of the updated hosts under the `hostids` property.

Examples

Enabling a host

Enable host monitoring, that is, set its status to "0".

Request:

```
{
  "jsonrpc": "2.0",
  "method": "host.update",
  "params": {
    "hostid": "10126",
    "status": 0
  },
  "id": 1
}
```

Response:

```
{
  "jsonrpc": "2.0",
  "result": {
    "hostids": [
      "10126"
    ]
  },
  "id": 1
}
```

Unlinking templates

Unlink and clear two templates from host.

Request:

```
{
  "jsonrpc": "2.0",
  "method": "host.update",
  "params": {
    "hostid": "10126",
    "templates_clear": [
      {
        "templateid": "10124"
      },
      {
        "templateid": "10125"
      }
    ]
  },
  "id": 1
}
```

Response:

```
{
  "jsonrpc": "2.0",
  "result": {
    "hostids": [
      "10126"
    ]
  },
  "id": 1
}
```

Updating host macros

Replace all host macros with two new ones.

Request:

```
{
  "jsonrpc": "2.0",
  "method": "host.update",
  "params": {
    "hostid": "10126",
    "macros": [
      {
        "macro": "${PASS}",
        "value": "password"
      },
      {
        "macro": "${DISC}",
        "value": "sda",
        "description": "Updated description"
      }
    ]
  },
  "id": 1
}
```

Response:

```
{
  "jsonrpc": "2.0",
  "result": {
    "hostids": [
      "10126"
    ]
  },
  "id": 1
}
```

Updating host inventory

Change inventory mode and add location

Request:

```
{
  "jsonrpc": "2.0",
  "method": "host.update",
  "params": {
    "hostid": "10387",
    "inventory_mode": 0,
    "inventory": {
      "location": "Latvia, Riga"
    }
  },
  "id": 1
}
```

Response:

```
{
  "jsonrpc": "2.0",
  "result": {
    "hostids": [
      "10387"
    ]
  },
  "id": 1
}
```

Updating host tags

Replace all host tags with a new one.

Request:

```
{
  "jsonrpc": "2.0",
  "method": "host.update",
  "params": {
    "hostid": "10387",
    "tags": {
      "tag": "os",
      "value": "rhel-7"
    }
  },
  "id": 1
}
```

Response:

```
{
  "jsonrpc": "2.0",
  "result": {
    "hostids": [
      "10387"
    ]
  },
  "id": 1
}
```

Updating discovered host macros

Convert discovery rule created "automatic" macro to "manual" and change its value to "new-value".

Request:

```
{
  "jsonrpc": "2.0",
  "method": "host.update",
  "params": {
    "hostid": "10387",
    "macros": {
      "hostmacroid": "5541",
      "value": "new-value",
      "automatic": "0"
    }
  },
  "id": 1
}
```

Response:

```
{
  "jsonrpc": "2.0",
  "result": {
    "hostids": [
      "10387"
    ]
  },
  "id": 1
}
```

Updating host encryption

Update the host "10590" to use PSK encryption only for connections from host to Zabbix server, and change the PSK identity and PSK key. Note that the host has to be **pre-configured to use PSK**.

Request:

```
{
  "jsonrpc": "2.0",
  "method": "host.update",
```

```
"params": {
  "hostid": "10590",
  "tls_connect": 1,
  "tls_accept": 2,
  "tls_psk_identity": "PSK 002",
  "tls_psk": "e560cb0d918d26d31b4f642181f5f570ad89a390931102e5391d08327ba434e9"
},
"id": 1
}
```

Response:

```
{
  "jsonrpc": "2.0",
  "result": {
    "hostids": [
      "10590"
    ]
  },
  "id": 1
}
```

See also

- [host.massadd](#)
- [host.massupdate](#)
- [host.massremove](#)
- [Host group](#)
- [Template](#)
- [User macro](#)
- [Host interface](#)
- [Host inventory](#)
- [Host tag](#)
- [Proxy](#)
- [Proxy group](#)

Source

`CHost::update()` in `ui/include/classes/api/services/CHost.php`.

Host group

This class is designed to work with host groups.

Object references:

- [Host group](#)

Available methods:

- [hostgroup.create](#) - create new host groups
- [hostgroup.delete](#) - delete host groups
- [hostgroup.get](#) - retrieve host groups
- [hostgroup.massadd](#) - add related objects to host groups
- [hostgroup.massremove](#) - remove related objects from host groups
- [hostgroup.massupdate](#) - replace or remove related objects from host groups
- [hostgroup.propagate](#) - propagate permissions and tag filters to host groups' subgroups
- [hostgroup.update](#) - update host groups

Host group object

The following objects are directly related to the `hostgroup` API.

Host group

The host group object has the following properties.

Property	Type	Description
groupid	ID	ID of the host group.
name	string	<p>Property behavior:</p> <ul style="list-style-type: none"> - <i>read-only</i> - <i>required</i> for update operations Name of the host group.
flags	integer	<p>Property behavior:</p> <ul style="list-style-type: none"> - <i>required</i> for create operations Origin of the host group. <p>Possible values:</p> <ul style="list-style-type: none"> 0 - a plain host group; 4 - a discovered host group.
uuid	string	<p>Property behavior:</p> <ul style="list-style-type: none"> - <i>read-only</i> Universal unique identifier, used for linking imported host groups to already existing ones. Auto-generated, if not given.

hostgroup.create

Description

object hostgroup.create(object/array hostGroups)

This method allows to create new host groups.

Note:

This method is only available to *Super admin* user type. Permissions to call the method can be revoked in user role settings. See [User roles](#) for more information.

Parameters

(object/array) Host groups to create.

The method accepts host groups with the **standard host group properties**.

Return values

(object) Returns an object containing the IDs of the created host groups under the `groupids` property. The order of the returned IDs matches the order of the passed host groups.

Examples

Creating a host group

Create a host group called "Linux servers".

Request:

```
{
  "jsonrpc": "2.0",
  "method": "hostgroup.create",
  "params": {
    "name": "Linux servers"
  },
  "id": 1
}
```

Response:

```
{
  "jsonrpc": "2.0",
  "result": {
    "groupids": [
```



```
        "107819"
    ],
},
"id": 1
}
```

Source

`CHostGroup::create()` in `ui/include/classes/api/services/CHostGroup.php`.

hostgroup.delete

Description

`object hostgroup.delete(array hostGroupIds)`

This method allows to delete host groups.

A host group cannot be deleted if:

- it contains hosts that belong to this group only;
- it is marked as internal;
- it is used by a host prototype;
- it is used in a global script;
- it is used in a correlation condition.

Note:

This method is only available to *Admin* and *Super admin* user types. Permissions to call the method can be revoked in user role settings. See [User roles](#) for more information.

Parameters

(array) IDs of the host groups to delete.

Return values

(object) Returns an object containing the IDs of the deleted host groups under the `groupids` property.

Examples

Deleting multiple host groups

Delete two host groups.

Request:

```
{
  "jsonrpc": "2.0",
  "method": "hostgroup.delete",
  "params": [
    "107824",
    "107825"
  ],
  "id": 1
}
```

Response:

```
{
  "jsonrpc": "2.0",
  "result": {
    "groupids": [
      "107824",
      "107825"
    ]
  },
  "id": 1
}
```

Source

`CHostGroup::delete()` in `ui/include/classes/api/services/CHostGroup.php`.

hostgroup.get

Description

`integer/array hostgroup.get(object parameters)`

The method allows to retrieve host groups according to the given parameters.

Note:

This method is available to users of any type. Permissions to call the method can be revoked in user role settings. See [User roles](#) for more information.

Parameters

(object) Parameters defining the desired output.

The method supports the following parameters.

Parameter	Type	Description
<code>graphids</code>	ID/array	Return only host groups that contain hosts with the given graphs.
<code>groupids</code>	ID/array	Return only host groups with the given host group IDs.
<code>hostids</code>	ID/array	Return only host groups that contain the given hosts.
<code>maintenanceids</code>	ID/array	Return only host groups that are affected by the given maintenances.
<code>triggerids</code>	ID/array	Return only host groups that contain hosts with the given triggers.
<code>with_graphs</code>	flag	Return only host groups that contain hosts with graphs.
<code>with_graph_prototypes</code>	flag	Return only host groups that contain hosts with graph prototypes.
<code>with_hosts</code>	flag	Return only host groups that contain hosts.
<code>with_httptests</code>	flag	Return only host groups that contain hosts with web checks.
<code>with_items</code>	flag	Overrides the <code>with_monitored_httptests</code> parameter. Return only host groups that contain hosts with items.
<code>with_item_prototypes</code>	flag	Overrides the <code>with_monitored_items</code> and <code>with_simple_graph_items</code> parameters. Return only host groups that contain hosts with item prototypes.
<code>with_simple_graph_item_prototypes</code>	flag	Overrides the <code>with_simple_graph_item_prototypes</code> parameter. Return only host groups that contain hosts with item prototypes, which are enabled for creation and have numeric type of information.
<code>with_monitored_httptests</code>	flag	Return only host groups that contain hosts with enabled web checks.
<code>with_monitored_hosts</code>	flag	Return only host groups that contain monitored hosts.
<code>with_monitored_items</code>	flag	Return only host groups that contain hosts with enabled items.
<code>with_monitored_triggers</code>	flag	Overrides the <code>with_simple_graph_items</code> parameter. Return only host groups that contain hosts with enabled triggers. All of the items used in the trigger must also be enabled.
<code>with_simple_graph_items</code>	flag	Return only host groups that contain hosts with numeric items.
<code>with_triggers</code>	flag	Return only host groups that contain hosts with triggers.
<code>selectDiscoveryRules</code>	query	Overrides the <code>with_monitored_triggers</code> parameter. Return a <code>discoveryRules</code> property with the LLD rules that discovered the host group.

Parameter	Type	Description
selectGroupDiscoveries	query	Return a <code>groupDiscoveries</code> property with the host group discovery objects. Each host group discovery object is a host group prototype linked to the discovered host group and has the following properties: <code>parent_group_prototypeid</code> - (ID) ID of the host group prototype from which the host group was discovered; <code>name</code> - (string) name of the host group prototype; <code>lastcheck</code> - (timestamp) time when the host group was last discovered; <code>ts_delete</code> - (timestamp) time when the host group that is no longer discovered will be deleted; <code>status</code> - (int) host group discovery status: 0 - (default) host group is discovered, 1 - host group is not discovered anymore.
selectHostPrototypes	query	Return a <code>hostPrototypes</code> property with host prototypes that discovered this host group.
selectHosts	query	Return a <code>hosts</code> property with the hosts that belong to the host group.
limitSelects	integer	Supports count. Limits the number of records returned by subselects.
sortfield	string/array	Applies to the following subselects: <code>selectHosts</code> - results will be sorted by host. Sort the result by the given properties.
countOutput	boolean	Possible values: <code>groupid</code> , <code>name</code> . These parameters being common for all get methods are described in detail in the reference commentary page.
editable	boolean	
excludeSearch	boolean	
filter	object	
limit	integer	
output	query	
preservekeys	boolean	
search	object	
searchByAny	boolean	
searchWildcardsEnabled	boolean	
sortorder	string/array	
startSearch	boolean	

Return values

(integer/array) Returns either:

- an array of objects;
- the count of retrieved objects, if the `countOutput` parameter has been used.

Examples

Retrieving data by name

Retrieve all data about two host groups named "Zabbix servers" and "Linux servers".

Request:

```
{
  "jsonrpc": "2.0",
  "method": "hostgroup.get",
  "params": {
    "output": "extend",
    "filter": {
      "name": [
        "Zabbix servers",
```

```

        "Linux servers"
    ]
}
},
"id": 1
}

```

Response:

```

{
  "jsonrpc": "2.0",
  "result": [
    {
      "groupid": "2",
      "name": "Linux servers",
      "internal": "0"
    },
    {
      "groupid": "4",
      "name": "Zabbix servers",
      "internal": "0"
    }
  ],
  "id": 1
}

```

See also

- [Host](#)

Source

`CHostGroup::get()` in `ui/include/classes/api/services/CHostGroup.php`.

hostgroup.massadd

Description

`object hostgroup.massadd(object parameters)`

This method allows to simultaneously add multiple related objects to all the given host groups.

Note:

This method is only available to *Admin* and *Super admin* user types. Permissions to call the method can be revoked in user role settings. See [User roles](#) for more information.

Parameters

(object) Parameters containing the IDs of the host groups to update and the objects to add to all the host groups.

The method accepts the following parameters.

Parameter	Type	Description
groups	object/array	<p>Host groups to be updated.</p> <p>The host groups must have only the <code>groupid</code> property defined.</p> <p>Parameter behavior: - <i>required</i></p>
hosts	object/array	<p>Hosts to add to all host groups.</p> <p>The hosts must have only the <code>hostid</code> property defined.</p>

Return values

(object) Returns an object containing the IDs of the updated host groups under the `groupids` property.

Examples

Adding hosts to host groups

Add two hosts to host groups with IDs 5 and 6.

Request:

```
{
  "jsonrpc": "2.0",
  "method": "hostgroup.massadd",
  "params": {
    "groups": [
      {
        "groupid": "5"
      },
      {
        "groupid": "6"
      }
    ],
    "hosts": [
      {
        "hostid": "30050"
      },
      {
        "hostid": "30001"
      }
    ]
  },
  "id": 1
}
```

Response:

```
{
  "jsonrpc": "2.0",
  "result": {
    "groupids": [
      "5",
      "6"
    ]
  },
  "id": 1
}
```

See also

- [Host](#)

Source

`CHostGroup::massAdd()` in `ui/include/classes/api/services/CHostGroup.php`.

hostgroup.massremove

Description

`object hostgroup.massremove(object parameters)`

This method allows to remove related objects from multiple host groups.

Note:

This method is only available to *Admin* and *Super admin* user types. Permissions to call the method can be revoked in user role settings. See [User roles](#) for more information.

Parameters

(object) Parameters containing the IDs of the host groups to update and the objects that should be removed.

Parameter	Type	Description
groupids	ID/array	IDs of the host groups to be updated.
hostids	ID/array	IDs of the hosts to remove from all host groups.

Parameter behavior:

- *required*

Return values

(object) Returns an object containing the IDs of the updated host groups under the `groupids` property.

Examples

Removing hosts from host groups

Remove two hosts from the given host groups.

Request:

```
{
  "jsonrpc": "2.0",
  "method": "hostgroup.massremove",
  "params": {
    "groupids": [
      "5",
      "6"
    ],
    "hostids": [
      "30050",
      "30001"
    ]
  },
  "id": 1
}
```

Response:

```
{
  "jsonrpc": "2.0",
  "result": {
    "groupids": [
      "5",
      "6"
    ]
  },
  "id": 1
}
```

Source

`CHostGroup::massRemove()` in `ui/include/classes/api/services/CHostGroup.php`.

hostgroup.massupdate

Description

object `hostgroup.massupdate(object parameters)`

This method allows to replace hosts and templates with the specified ones in multiple host groups.

Note:

This method is only available to *Admin* and *Super admin* user types. Permissions to call the method can be revoked in user role settings. See [User roles](#) for more information.

Parameters

(object) Parameters containing the IDs of the host groups to update and the objects that should be updated.

Parameter	Type	Description
groups	object/array	<p>Host groups to be updated.</p> <p>The host groups must have only the <code>groupid</code> property defined.</p> <p>Parameter behavior: - <i>required</i></p>
hosts	object/array	<p>Hosts to replace the current hosts on the given host groups. All other hosts, except the ones mentioned, will be excluded from host groups. Discovered hosts will not be affected.</p> <p>The hosts must have only the <code>hostid</code> property defined.</p> <p>Parameter behavior: - <i>required</i></p>

Return values

(object) Returns an object containing the IDs of the updated host groups under the `groupids` property.

Examples

Replacing hosts in a host group

Replace all hosts in a host group to ones mentioned host.

Request:

```
{
  "jsonrpc": "2.0",
  "method": "hostgroup.massupdate",
  "params": {
    "groups": [
      {
        "groupid": "6"
      }
    ],
    "hosts": [
      {
        "hostid": "30050"
      }
    ]
  },
  "id": 1
}
```

Response:

```
{
  "jsonrpc": "2.0",
  "result": {
    "groupids": [
      "6",
    ]
  },
  "id": 1
}
```

See also

- [hostgroup.update](#)
- [hostgroup.massadd](#)
- [Host](#)

Source

CHostGroup::massUpdate() in *ui/include/classes/api/services/CHostGroup.php*.

hostgroup.propagate

Description

object hostgroup.propagate(object parameters)

This method allows to apply permissions and tag filters to all subgroups of a host group.

Note:

This method is only available to *Super admin* user types. Permissions to call the method can be revoked in user role settings. See [User roles](#) for more information.

Parameters

(object) Parameters defining the desired output.

The method supports the following parameters.

Parameter	Type	Description
groups	object/array	Host groups to propagate. The host groups must have the <code>groupid</code> property defined. Parameter behavior: - <i>required</i>
permissions	boolean	Set to "true" to propagate permissions. Parameter behavior: - <i>required</i> if <code>tag_filters</code> is not set
tag_filters	boolean	Set to "true" to propagate tag filters. Parameter behavior: - <i>required</i> if <code>permissions</code> is not set

Return values

(object) Returns an object containing the IDs of the propagated host groups under the `groupids` property.

Examples

Propagating host group permissions and tag filters to its subgroups.

Propagate host group permissions and tag filters to its subgroups.

Request:

```
{
  "jsonrpc": "2.0",
  "method": "hostgroup.propagate",
  "params": {
    "groups": [
      {
        "groupid": "6"
      }
    ],
    "permissions": true,
    "tag_filters": true
  },
  "id": 1
}
```

Response:

```
{
  "jsonrpc": "2.0",
  "result": {
    "groupids": [
      "6",
    ]
  },
  "id": 1
}
```

See also

- [hostgroup.update](#)
- [hostgroup.massadd](#)
- [Host](#)

Source

`CHostGroup::propagate()` in `ui/include/classes/api/services/CHostGroup.php`.

hostgroup.update

Description

object `hostgroup.update(object/array hostGroups)`

This method allows to update existing hosts groups.

Note:

This method is only available to *Admin* and *Super admin* user types. Permissions to call the method can be revoked in user role settings. See [User roles](#) for more information.

Parameters

(object/array) **Host group properties** to be updated.

The `groupid` property must be defined for each host group, all other properties are optional. Only the given properties will be updated, all others will remain unchanged.

Return values

(object) Returns an object containing the IDs of the updated host groups under the `groupids` property.

Examples

Renaming a host group

Rename a host group to "Linux hosts."

Request:

```
{
  "jsonrpc": "2.0",
  "method": "hostgroup.update",
  "params": {
    "groupid": "7",
    "name": "Linux hosts"
  },
  "id": 1
}
```

Response:

```
{
  "jsonrpc": "2.0",
  "result": {
    "groupids": [
      "7"
    ]
  },
}
```

```
"id": 1  
}
```

Source

`CHostGroup::update()` in `ui/include/classes/api/services/CHostGroup.php`.

Host interface

This class is designed to work with host interfaces.

Object references:

- [Host interface](#)
- [Details](#)

Available methods:

- `hostinterface.create` - create new host interfaces
- `hostinterface.delete` - delete host interfaces
- `hostinterface.get` - retrieve host interfaces
- `hostinterface.massadd` - add host interfaces to hosts
- `hostinterface.massremove` - remove host interfaces from hosts
- `hostinterface.replacehostinterfaces` - replace host interfaces on a host
- `hostinterface.update` - update host interfaces

Host interface object

The following objects are directly related to the `hostinterface` API.

Host interface

The host interface object has the following properties.

Attention:

Note that both `ip` and `dns` properties are *required* for create operations. If you do not want to use DNS, set it to an empty string.

Property	Type	Description
<code>interfaceid</code>	ID	ID of the interface.
<code>available</code>	integer	<p>Property behavior:</p> <ul style="list-style-type: none">- <i>read-only</i>- <i>required</i> for update operations Availability of host interface.
<code>hostid</code>	ID	<p>Possible values:</p> <ul style="list-style-type: none">0 - (<i>default</i>) unknown;1 - available;2 - unavailable. <p>Property behavior:</p> <ul style="list-style-type: none">- <i>read-only</i> ID of the host that the interface belongs to.
		<p>Property behavior:</p> <ul style="list-style-type: none">- <i>constant</i>- <i>required</i> for create operations

Property	Type	Description
type	integer	Interface type. Possible values: 1 - Agent; 2 - SNMP; 3 - IPMI; 4 - JMX.
ip	string	Property behavior: - <i>required</i> for create operations IP address used by the interface. Can be empty if the connection is made via DNS.
dns	string	Property behavior: - <i>required</i> for create operations DNS name used by the interface. Can be empty if the connection is made via IP.
port	string	Property behavior: - <i>required</i> for create operations Port number used by the interface. Can contain user macros.
useip	integer	Property behavior: - <i>required</i> for create operations Whether the connection should be made via IP. Possible values: 0 - connect using host DNS name; 1 - connect using host IP address.
main	integer	Property behavior: - <i>required</i> for create operations Whether the interface is used as default on the host. Only one interface of some type can be set as default on a host. Possible values: 0 - not default; 1 - default.
details	array	Property behavior: - <i>required</i> for create operations Additional details object for interface.
disable_until	timestamp	Property behavior: - <i>required</i> if <code>type</code> is set to "SNMP" The next polling time of an unavailable host interface.
error	string	Property behavior: - <i>read-only</i> Error text if host interface is unavailable.
errors_from	timestamp	Property behavior: - <i>read-only</i> Time when host interface became unavailable.
		Property behavior: - <i>read-only</i>

Details

The details object has the following properties.

Property	Type	Description
version	integer	SNMP interface version. Possible values: 1 - SNMPv1; 2 - SNMPv2c; 3 - SNMPv3.
bulk	integer	Property behavior: - <i>required</i> Whether to use bulk SNMP requests. Possible values: 0 - don't use bulk requests; 1 - (default) - use bulk requests.
community	string	SNMP community. Used only by SNMPv1 and SNMPv2 interfaces. Property behavior: - <i>required</i> if <code>version</code> is set to "SNMPv1" or "SNMPv2c"
max_repetitions	integer	Max repetition value for native SNMP bulk requests (GetBulkRequest-PDUs). Used only for <code>discovery []</code> and <code>walk []</code> items in SNMPv2 and v3.
securityname	string	Default: 10. SNMPv3 security name. Used only by SNMPv3 interfaces.
securitylevel	integer	SNMPv3 security level. Used only by SNMPv3 interfaces. Possible values: 0 - (default) - noAuthNoPriv; 1 - authNoPriv; 2 - authPriv.
authpassphrase	string	SNMPv3 authentication passphrase. Used only by SNMPv3 interfaces.
privpassphrase	string	SNMPv3 privacy passphrase. Used only by SNMPv3 interfaces.
authprotocol	integer	SNMPv3 authentication protocol. Used only by SNMPv3 interfaces. Possible values: 0 - (default) - MD5; 1 - SHA1; 2 - SHA224; 3 - SHA256; 4 - SHA384; 5 - SHA512.
privprotocol	integer	SNMPv3 privacy protocol. Used only by SNMPv3 interfaces. Possible values: 0 - (default) - DES; 1 - AES128; 2 - AES192; 3 - AES256; 4 - AES192C; 5 - AES256C.
contextname	string	SNMPv3 context name. Used only by SNMPv3 interfaces.

hostinterface.create

Description

`object hostinterface.create(object/array hostInterfaces)`

This method allows to create new host interfaces.

Note:

This method is only available to *Admin* and *Super admin* user types. Permissions to call the method can be revoked in user role settings. See [User roles](#) for more information.

Parameters

(object/array) Host interfaces to create.

The method accepts host interfaces with the [standard host interface properties](#).

Return values

(object) Returns an object containing the IDs of the created host interfaces under the `interfaceids` property. The order of the returned IDs matches the order of the passed host interfaces.

Examples

Create a new interface

Create a secondary IP agent interface on host "30052."

Request:

```
{
  "jsonrpc": "2.0",
  "method": "hostinterface.create",
  "params": {
    "hostid": "30052",
    "main": "0",
    "type": "1",
    "useip": "1",
    "ip": "127.0.0.1",
    "dns": "",
    "port": "10050"
  },
  "id": 1
}
```

Response:

```
{
  "jsonrpc": "2.0",
  "result": {
    "interfaceids": [
      "30062"
    ]
  },
  "id": 1
}
```

Create an interface with SNMP details

Request:

```
{
  "jsonrpc": "2.0",
  "method": "hostinterface.create",
  "params": {
    "hostid": "10456",
    "main": "0",
    "type": "2",
    "useip": "1",
    "ip": "127.0.0.1",
    "dns": "",
    "port": "1601",
    "details": {
      "version": "2",

```

```
        "bulk": "1",
        "community": "${SNMP_COMMUNITY}"
    }
},
"id": 1
}
```

Response:

```
{
  "jsonrpc": "2.0",
  "result": {
    "interfaceids": [
      "30063"
    ]
  },
  "id": 1
}
```

See also

- [hostinterface.massadd](#)
- [host.massadd](#)

Source

`CHostInterface::create()` in `ui/include/classes/api/services/CHostInterface.php`.

hostinterface.delete

Description

object `hostinterface.delete(array hostInterfaceIds)`

This method allows to delete host interfaces.

Note:

This method is only available to *Admin* and *Super admin* user types. Permissions to call the method can be revoked in user role settings. See [User roles](#) for more information.

Parameters

(array) IDs of the host interfaces to delete.

Return values

(object) Returns an object containing the IDs of the deleted host interfaces under the `interfaceids` property.

Examples

Delete a host interface

Delete the host interface with ID 30062.

Request:

```
{
  "jsonrpc": "2.0",
  "method": "hostinterface.delete",
  "params": [
    "30062"
  ],
  "id": 1
}
```

Response:

```
{
  "jsonrpc": "2.0",
  "result": {
```

```

        "interfaceids": [
            "30062"
        ]
    },
    "id": 1
}

```

See also

- [hostinterface.massremove](#)
- [host.massremove](#)

Source

`CHostInterface::delete()` in `ui/include/classes/api/services/CHostInterface.php`.

hostinterface.get

Description

integer/array `hostinterface.get(object parameters)`

The method allows to retrieve host interfaces according to the given parameters.

Note:

This method is available to users of any type. Permissions to call the method can be revoked in user role settings. See [User roles](#) for more information.

Parameters

(object) Parameters defining the desired output.

The method supports the following parameters.

Parameter	Type	Description
hostids	ID/array	Return only host interfaces used by the given hosts.
interfaceids	ID/array	Return only host interfaces with the given IDs.
itemids	ID/array	Return only host interfaces used by the given items.
triggerids	ID/array	Return only host interfaces used by items in the given triggers.
selectItems	query	Return an <code>items</code> property with the items that use the interface.
selectHosts	query	Supports count. Return a <code>hosts</code> property with an array of hosts that use the interface.
limitSelects	integer	Limits the number of records returned by subselects.
sortfield	string/array	Applies to the following subselects: <code>selectItems</code> . Sort the result by the given properties.
countOutput	boolean	Possible values: <code>interfaceid</code> , <code>dns</code> , <code>ip</code> . These parameters being common for all get methods are described in detail in the reference commentary page.
editable	boolean	
excludeSearch	boolean	
filter	object	
limit	integer	
output	query	
preservekeys	boolean	
search	object	
searchByAny	boolean	
searchWildcardsEnabled	boolean	
sortorder	string/array	
startSearch	boolean	

Return values

(integer/array) Returns either:

- an array of objects;
- the count of retrieved objects, if the `countOutput` parameter has been used.

Examples

Retrieve host interfaces

Retrieve all data about the interfaces used by host "30057."

Request:

```
{
  "jsonrpc": "2.0",
  "method": "hostinterface.get",
  "params": {
    "output": "extend",
    "hostids": "30057"
  },
  "id": 1
}
```

Response:

```
{
  "jsonrpc": "2.0",
  "result": [
    {
      "interfaceid": "50039",
      "hostid": "30057",
      "main": "1",
      "type": "1",
      "useip": "0",
      "ip": "",
      "dns": "localhost",
      "port": "10050",
      "available": "0",
      "error": "",
      "errors_from": "0",
      "disable_until": "0",
      "details": []
    },
    {
      "interfaceid": "55082",
      "hostid": "30057",
      "main": "1",
      "type": "2",
      "useip": "1",
      "ip": "127.0.0.1",
      "dns": "",
      "port": "161",
      "available": "0",
      "error": "",
      "errors_from": "0",
      "disable_until": "0",
      "details": {
        "version": "2",
        "bulk": "0",
        "community": "${SNMP_COMMUNITY}",
        "max_repetitions": "10"
      }
    }
  ],
  "id": 1
}
```

See also

- [Host](#)
- [Item](#)

Source

`CHostInterface::get()` in `ui/include/classes/api/services/CHostInterface.php`.

hostinterface.massadd

Description

`object hostinterface.massadd(object parameters)`

This method allows to simultaneously add host interfaces to multiple hosts.

Note:

This method is only available to *Admin* and *Super admin* user types. Permissions to call the method can be revoked in user role settings. See [User roles](#) for more information.

Parameters

(object) Parameters containing the host interfaces to be created on the given hosts.

The method accepts the following parameters.

Parameter	Type	Description
interfaces	object/array	Host interfaces to create on the given hosts. Parameter behavior: - <i>required</i>
hosts	object/array	Hosts to be updated. The hosts must have only the <code>hostid</code> property defined. Parameter behavior: - <i>required</i>

Return values

(object) Returns an object containing the IDs of the created host interfaces under the `interfaceids` property.

Examples

Creating interfaces

Create an interface on two hosts.

Request:

```
{
  "jsonrpc": "2.0",
  "method": "hostinterface.massadd",
  "params": {
    "hosts": [
      {
        "hostid": "30050"
      },
      {
        "hostid": "30052"
      }
    ],
    "interfaces": {
      "dns": "",
      "ip": "127.0.0.1",
      "main": 0,
    }
  }
}
```

```

        "port": "10050",
        "type": 1,
        "useip": 1
    }
},
"id": 1
}

```

Response:

```

{
  "jsonrpc": "2.0",
  "result": {
    "interfaceids": [
      "30069",
      "30070"
    ]
  },
  "id": 1
}

```

See also

- [hostinterface.create](#)
- [host.massadd](#)
- [Host](#)

Source

`CHostInterface::massAdd()` in `ui/include/classes/api/services/CHostInterface.php`.

hostinterface.massremove

Description

`object hostinterface.massremove(object parameters)`

This method allows to remove host interfaces from the given hosts.

Note:

This method is only available to *Admin* and *Super admin* user types. Permissions to call the method can be revoked in user role settings. See [User roles](#) for more information.

Parameters

(object) Parameters containing the IDs of the hosts to be updated and the interfaces to be removed.

Parameter	Type	Description
interfaces	object/array	<p>Host interfaces to remove from the given hosts.</p> <p>The host interface object must have only the <code>ip</code>, <code>dns</code> and <code>port</code> properties defined.</p> <p>Parameter behavior:</p> <ul style="list-style-type: none"> - <i>required</i>
hostids	ID/array	<p>IDs of the hosts to be updated.</p> <p>Parameter behavior:</p> <ul style="list-style-type: none"> - <i>required</i>

Return values

(object) Returns an object containing the IDs of the deleted host interfaces under the `interfaceids` property.

Examples

Removing interfaces

Remove the "127.0.0.1" SNMP interface from two hosts.

Request:

```
{
  "jsonrpc": "2.0",
  "method": "hostinterface.massremove",
  "params": {
    "hostids": [
      "30050",
      "30052"
    ],
    "interfaces": {
      "dns": "",
      "ip": "127.0.0.1",
      "port": "161"
    }
  },
  "id": 1
}
```

Response:

```
{
  "jsonrpc": "2.0",
  "result": {
    "interfaceids": [
      "30069",
      "30070"
    ]
  },
  "id": 1
}
```

See also

- [hostinterface.delete](#)
- [host.massremove](#)

Source

`CHostInterface::massRemove()` in `ui/include/classes/api/services/CHostInterface.php`.

hostinterface.replacehostinterfaces

Description

object `hostinterface.replacehostinterfaces(object parameters)`

This method allows to replace all host interfaces on a given host.

Note:

This method is only available to *Admin* and *Super admin* user types. Permissions to call the method can be revoked in user role settings. See [User roles](#) for more information.

Parameters

(object) Parameters containing the ID of the host to be updated and the new host interfaces.

Parameter	Type	Description
<code>interfaces</code>	object/array	Host interfaces to replace the current host interfaces with.

Parameter behavior:
- *required*

Parameter	Type	Description
hostid	ID	ID of the host to be updated.

Parameter behavior:
- *required*

Return values

(object) Returns an object containing the IDs of the created host interfaces under the `interfaceids` property.

Examples

Replacing host interfaces

Replace all host interfaces with a single agent interface.

Request:

```
{
  "jsonrpc": "2.0",
  "method": "hostinterface.replacehostinterfaces",
  "params": {
    "hostid": "30052",
    "interfaces": {
      "dns": "",
      "ip": "127.0.0.1",
      "main": 1,
      "port": "10050",
      "type": 1,
      "useip": 1
    }
  },
  "id": 1
}
```

Response:

```
{
  "jsonrpc": "2.0",
  "result": {
    "interfaceids": [
      "30081"
    ]
  },
  "id": 1
}
```

See also

- [host.update](#)
- [host.massupdate](#)

Source

`CHostInterface::replaceHostInterfaces()` in `ui/include/classes/api/services/CHostInterface.php`.

hostinterface.update

Description

object `hostinterface.update(object/array hostInterfaces)`

This method allows to update existing host interfaces.

Note:

This method is only available to *Admin* and *Super admin* user types. Permissions to call the method can be revoked in user role settings. See [User roles](#) for more information.

Parameters

(object/array) **Host interface properties** to be updated.

The `interfaceid` property must be defined for each host interface, all other properties are optional. Only the given properties will be updated, all others will remain unchanged.

Return values

(object) Returns an object containing the IDs of the updated host interfaces under the `interfaceids` property.

Examples

Changing a host interface port

Change the port of a host interface.

Request:

```
{
  "jsonrpc": "2.0",
  "method": "hostinterface.update",
  "params": {
    "interfaceid": "30048",
    "port": "30050"
  },
  "id": 1
}
```

Response:

```
{
  "jsonrpc": "2.0",
  "result": {
    "interfaceids": [
      "30048"
    ]
  },
  "id": 1
}
```

Source

`CHostInterface::update()` in `ui/include/classes/api/services/CHostInterface.php`.

Host prototype

This class is designed to work with host prototypes.

Object references:

- [Host prototype](#)
- [Group link](#)
- [Group prototype](#)
- [Host prototype tag](#)
- [Custom interface](#)
- [Custom interface details](#)

Available methods:

- [hostprototype.create](#) - create new host prototypes
- [hostprototype.delete](#) - delete host prototypes
- [hostprototype.get](#) - retrieve host prototypes
- [hostprototype.update](#) - update host prototypes

Host prototype object

The following objects are directly related to the `hostprototype` API.

Host prototype

The host prototype object has the following properties.

Property	Type	Description
hostid	ID	ID of the host prototype. Property behavior: - <i>read-only</i>
host	string	- <i>required</i> for update operations Technical name of the host prototype. Property behavior: - <i>required</i> for create operations - <i>read-only</i> for inherited objects
name	string	Visible name of the host prototype. Default: <code>host</code> property value. Property behavior: - <i>read-only</i> for inherited objects
status	integer	Status of the host prototype. Possible values: 0 - (<i>default</i>) monitored host; 1 - unmonitored host.
inventory_mode	integer	Host inventory population mode. Possible values: -1 - (<i>default</i>) disabled; 0 - manual; 1 - automatic.
templateid	ID	ID of the parent template host prototype. Property behavior: - <i>read-only</i>
discover	integer	Host prototype discovery status. Possible values: 0 - (<i>default</i>) new hosts will be discovered; 1 - new hosts will not be discovered and existing hosts will be marked as lost.
custom_interfaces	integer	Source of custom interfaces for hosts created by the host prototype. Possible values: 0 - (<i>default</i>) inherit interfaces from parent host; 1 - use host prototypes custom interfaces. Property behavior: - <i>read-only</i> for inherited objects
uuid	string	Universal unique identifier, used for linking imported host prototypes to already existing ones. Auto-generated, if not given. Property behavior: - <i>supported</i> if the host prototype belongs to a template

Group link

The group link object links a host prototype with a host group. It has the following properties.

Property	Type	Description
groupid	ID	ID of the host group. Property behavior: - <i>required</i>

Group prototype

The group prototype object defines a group that will be created for a discovered host. It has the following properties.

Property	Type	Description
name	string	Name of the group prototype. Property behavior: - <i>required</i>

Host prototype tag

The host prototype tag object has the following properties.

Property	Type	Description
tag	string	Host prototype tag name. Property behavior: - <i>required</i>
value	string	Host prototype tag value.

Custom interface

Custom interfaces are supported if `custom_interfaces` of **Host prototype object** is set to "use host prototypes custom interfaces". The custom interface object has the following properties.

Property	Type	Description
type	integer	Interface type. Possible values: 1 - Agent; 2 - SNMP; 3 - IPMI; 4 - JMX. Property behavior: - <i>required</i>
useip	integer	Whether the connection should be made via IP. Possible values: 0 - connect using host DNS name; 1 - connect using host IP address. Property behavior: - <i>required</i>
ip	string	IP address used by the interface. Can contain macros. Property behavior: - <i>required</i> if <code>useip</code> is set to "connect using host IP address"

Property	Type	Description
dns	string	DNS name used by the interface. Can contain macros.
port	string	<p>Property behavior: - <i>required</i> if useip is set to "connect using host DNS name"</p> Port number used by the interface. Can contain user and LLD macros.
main	integer	<p>Property behavior: - <i>required</i></p> Whether the interface is used as default on the host. Only one interface of some type can be set as default on a host.
details	array	<p>Possible values: 0 - not default; 1 - default.</p> <p>Property behavior: - <i>required</i></p> Additional object for interface.
		<p>Property behavior: - <i>required</i> if type is set to "SNMP"</p>

Custom interface details

The details object has the following properties.

Property	Type	Description
version	integer	SNMP interface version. Possible values: 1 - SNMPv1; 2 - SNMPv2c; 3 - SNMPv3.
bulk	integer	<p>Property behavior: - <i>required</i></p> Whether to use bulk SNMP requests. Possible values: 0 - don't use bulk requests; 1 - (<i>default</i>) - use bulk requests.
community	string	SNMP community.
max_repetitions	integer	<p>Property behavior: - <i>required</i> if version is set to "SNMPv1" or "SNMPv2c"</p> Max repetition value for native SNMP bulk requests (GetBulkRequest-PDUs). Used only for <code>discovery []</code> and <code>walk []</code> items in SNMPv2 and v3.
securityname	string	Default: 10. SNMPv3 security name. <p>Property behavior: - <i>supported</i> if version is set to "SNMPv3"</p>

Property	Type	Description
securitylevel	integer	SNMPv3 security level. Possible values: 0 - (default) - noAuthNoPriv; 1 - authNoPriv; 2 - authPriv. Property behavior: - supported if version is set to "SNMPv3"
authpassphrase	string	SNMPv3 authentication passphrase. Property behavior: - supported if version is set to "SNMPv3" and securitylevel is set to "authNoPriv" or "authPriv"
privpassphrase	string	SNMPv3 privacy passphrase. Property behavior: - supported if version is set to "SNMPv3" and securitylevel is set to "authPriv"
authprotocol	integer	SNMPv3 authentication protocol. Possible values: 0 - (default) - MD5; 1 - SHA1; 2 - SHA224; 3 - SHA256; 4 - SHA384; 5 - SHA512. Property behavior: - supported if version is set to "SNMPv3" and securitylevel is set to "authNoPriv" or "authPriv"
privprotocol	integer	SNMPv3 privacy protocol. Used only by SNMPv3 interfaces. Possible values: 0 - (default) - DES; 1 - AES128; 2 - AES192; 3 - AES256; 4 - AES192C; 5 - AES256C. Property behavior: - supported if version is set to "SNMPv3" and securitylevel is set to "authPriv"
contextname	string	SNMPv3 context name. Property behavior: - supported if version is set to "SNMPv3"

hostprototype.create

Description

object `hostprototype.create(object/array hostPrototypes)`

This method allows to create new host prototypes.

Note:

This method is only available to *Admin* and *Super admin* user types. Permissions to call the method can be revoked in user role settings. See [User roles](#) for more information.

Parameters

(object/array) Host prototypes to create.

Additionally to the [standard host prototype properties](#), the method accepts the following parameters.

Parameter	Type	Description
groupLinks	array	Group links to be created for the host prototype. Parameter behavior: - <i>required</i>
ruleid	ID	ID of the LLD rule that the host prototype belongs to. Parameter behavior: - <i>required</i>
groupPrototypes	array	Group prototypes to be created for the host prototype.
macros	object/array	User macros to be created for the host prototype.
tags	object/array	Host prototype tags .
interfaces	object/array	Host prototype custom interfaces .
templates	object/array	Templates to be linked to the host prototype. The templates must have only the <code>templateid</code> property defined.

Return values

(object) Returns an object containing the IDs of the created host prototypes under the `hostids` property. The order of the returned IDs matches the order of the passed host prototypes.

Examples**Creating a host prototype**

Create a host prototype `"{#VM.NAME}"` on LLD rule "23542" with a group prototype `"{#HV.NAME}"`, tag pair "datacenter": `"{#DATACENTER.NAME}"` and custom SNMPv2 interface 127.0.0.1:161 with community `{$SNMP_COMMUNITY}`. Link it to host group "2".

Request:

```
{
  "jsonrpc": "2.0",
  "method": "hostprototype.create",
  "params": {
    "host": "{#VM.NAME}",
    "ruleid": "23542",
    "custom_interfaces": "1",
    "groupLinks": [
      {
        "groupid": "2"
      }
    ],
    "groupPrototypes": [
      {
        "name": "{#HV.NAME}"
      }
    ],
    "tags": [
      {
        "tag": "datacenter",
        "value": "{#DATACENTER.NAME}"
      }
    ]
  },
}
```

```

    "interfaces": [
      {
        "main": "1",
        "type": "2",
        "useip": "1",
        "ip": "127.0.0.1",
        "dns": "",
        "port": "161",
        "details": {
          "version": "2",
          "bulk": "1",
          "community": "{$SNMP_COMMUNITY}"
        }
      }
    ]
  },
  "id": 1
}

```

Response:

```

{
  "jsonrpc": "2.0",
  "result": {
    "hostids": [
      "10103"
    ]
  },
  "id": 1
}

```

See also

- [Group link](#)
- [Group prototype](#)
- [Host prototype tag](#)
- [Custom interface](#)
- [User macro](#)

Source

`CHostPrototype::create()` in `ui/include/classes/api/services/CHostPrototype.php`.

hostprototype.delete

Description

object `hostprototype.delete(array hostPrototypeIds)`

This method allows to delete host prototypes.

Note:

This method is only available to *Admin* and *Super admin* user types. Permissions to call the method can be revoked in user role settings. See [User roles](#) for more information.

Parameters

(array) IDs of the host prototypes to delete.

Return values

(object) Returns an object containing the IDs of the deleted host prototypes under the `hostids` property.

Examples

Deleting multiple host prototypes

Delete two host prototypes.

Request:

```
{
  "jsonrpc": "2.0",
  "method": "hostprototype.delete",
  "params": [
    "10103",
    "10105"
  ],
  "id": 1
}
```

Response:

```
{
  "jsonrpc": "2.0",
  "result": {
    "hostids": [
      "10103",
      "10105"
    ]
  },
  "id": 1
}
```

Source

`CHostPrototype::delete()` in `ui/include/classes/api/services/CHostPrototype.php`.

hostprototype.get

Description

`integer/array hostprototype.get(object parameters)`

The method allows to retrieve host prototypes according to the given parameters.

Note:

This method is available to users of any type. Permissions to call the method can be revoked in user role settings. See [User roles](#) for more information.

Parameters

(object) Parameters defining the desired output.

The method supports the following parameters.

Parameter	Type	Description
hostids	ID/array	Return only host prototypes with the given IDs.
discoveryids	ID/array	Return only host prototypes that belong to the given LLD rules.
inherited	boolean	If set to <code>true</code> return only items inherited from a template.
selectDiscoveryRule	query	Return a <code>discoveryRule</code> property with the LLD rule that the host prototype belongs to.
selectInterfaces	query	Return an <code>interfaces</code> property with host prototype custom interfaces.
selectGroupLinks	query	Return a <code>groupLinks</code> property with the group links of the host prototype.
selectGroupPrototypes	query	Return a <code>groupPrototypes</code> property with the group prototypes of the host prototype.
selectMacros	query	Return a <code>macros</code> property with host prototype macros.
selectParentHost	query	Return a <code>parentHost</code> property with the host that the host prototype belongs to.
selectTags	query	Return a <code>tags</code> property with host prototype tags.

Parameter	Type	Description
selectTemplates	query	Return a <code>templates</code> property with the templates linked to the host prototype.
sortfield	string/array	Supports count. Sort the result by the given properties.
countOutput	boolean	Possible values: <code>hostid</code> , <code>host</code> , <code>name</code> , <code>status</code> . These parameters being common for all get methods are described in detail in the reference commentary .
editable	boolean	
excludeSearch	boolean	
filter	object	
limit	integer	
output	query	
preservekeys	boolean	
search	object	
searchByAny	boolean	
searchWildcardsEnabled	boolean	
sortorder	string/array	
startSearch	boolean	

Return values

(integer/array) Returns either:

- an array of objects;
- the count of retrieved objects, if the `countOutput` parameter has been used.

Examples

Retrieving host prototypes from an LLD rule

Retrieve all host prototypes, their group links, group prototypes and tags from an LLD rule.

Request:

```
{
  "jsonrpc": "2.0",
  "method": "hostprototype.get",
  "params": {
    "output": "extend",
    "selectInterfaces": "extend",
    "selectGroupLinks": "extend",
    "selectGroupPrototypes": "extend",
    "selectTags": "extend",
    "discoveryids": "23554"
  },
  "id": 1
}
```

Response:

```
{
  "jsonrpc": "2.0",
  "result": [
    {
      "hostid": "10092",
      "host": "#{HV.UUID}",
      "name": "#{HV.UUID}",
      "status": "0",
      "templateid": "0",
      "discover": "0",
      "custom_interfaces": "1",
      "inventory_mode": "-1",
      "groupLinks": [
```

```

        {
            "group_prototypeid": "4",
            "hostid": "10092",
            "groupid": "7",
            "templateid": "0"
        }
    ],
    "groupPrototypes": [
        {
            "group_prototypeid": "7",
            "hostid": "10092",
            "name": "#{CLUSTER.NAME}",
            "templateid": "0"
        }
    ],
    "tags": [
        {
            "tag": "datacenter",
            "value": "#{DATACENTER.NAME}"
        },
        {
            "tag": "instance-type",
            "value": "#{INSTANCE_TYPE}"
        }
    ],
    "interfaces": [
        {
            "main": "1",
            "type": "2",
            "useip": "1",
            "ip": "127.0.0.1",
            "dns": "",
            "port": "161",
            "details": {
                "version": "2",
                "bulk": "1",
                "community": "#{$SNMP_COMMUNITY}",
                "max_repetitions": "10"
            }
        }
    ]
}
],
    "id": 1
}
}

```

See also

- [Group link](#)
- [Group prototype](#)
- [User macro](#)

Source

`CHostPrototype::get()` in `ui/include/classes/api/services/CHostPrototype.php`.

hostprototype.update

Description

object `hostprototype.update(object/array hostPrototypes)`

This method allows to update existing host prototypes.

Note:

This method is only available to *Admin* and *Super admin* user types. Permissions to call the method can be revoked in user role settings. See [User roles](#) for more information.

Parameters

(object/array) Host prototype properties to be updated.

The `hostid` property must be defined for each host prototype, all other properties are optional. Only the passed properties will be updated, all others will remain unchanged.

Additionally to the [standard host prototype properties](#), the method accepts the following parameters.

Parameter	Type	Description
groupLinks	array	Group links to replace the current group links on the host prototype. Parameter behavior: - <i>read-only</i> for inherited objects
groupPrototypes	array	Group prototypes to replace the existing group prototypes on the host prototype. Parameter behavior: - <i>read-only</i> for inherited objects
macros	object/array	User macros to replace the current user macros. All macros that are not listed in the request will be removed.
tags	object/array	Host prototype tags to replace the current tags. All tags that are not listed in the request will be removed. Parameter behavior: - <i>read-only</i> for inherited objects
interfaces	object/array	Host prototype custom interfaces to replace the current interfaces. Custom interface object should contain all its parameters. All interfaces that are not listed in the request will be removed. Parameter behavior: - <i>supported</i> if <code>custom_interfaces</code> of Host prototype object is set to "use host prototypes custom interfaces" - <i>read-only</i> for inherited objects
templates	object/array	Templates to replace the currently linked templates. The templates must have only the <code>templateid</code> property defined.

Return values

(object) Returns an object containing the IDs of the updated host prototypes under the `hostids` property.

Examples**Disabling a host prototype**

Disable a host prototype, that is, set its status to "1".

Request:

```
{
  "jsonrpc": "2.0",
  "method": "hostprototype.update",
  "params": {
    "hostid": "10092",
    "status": 1
  },
  "id": 1
}
```

Response:

```
{
  "jsonrpc": "2.0",
  "result": {
    "hostids": [
      "10092"
    ]
  },
  "id": 1
}
```

Updating host prototype tags

Replace host prototype tags with new ones.

Request:

```
{
  "jsonrpc": "2.0",
  "method": "hostprototype.update",
  "params": {
    "hostid": "10092",
    "tags": [
      {
        "tag": "datacenter",
        "value": "#{DATACENTER.NAME}"
      },
      {
        "tag": "instance-type",
        "value": "#{INSTANCE_TYPE}"
      }
    ]
  },
  "id": 1
}
```

Response:

```
{
  "jsonrpc": "2.0",
  "result": {
    "hostids": [
      "10092"
    ]
  },
  "id": 1
}
```

Updating host prototype custom interfaces

Replace inherited interfaces with host prototype custom interfaces.

Request:

```
{
  "jsonrpc": "2.0",
  "method": "hostprototype.update",
  "params": {
    "hostid": "10092",
    "custom_interfaces": "1",
    "interfaces": [
      {
        "main": "1",
        "type": "2",
        "useip": "1",
        "ip": "127.0.0.1",
        "dns": "",
        "port": "161",
      }
    ]
  }
}
```



```

        "details": {
            "version": "2",
            "bulk": "1",
            "community": "{$SNMP_COMMUNITY}"
        }
    ],
    "id": 1
}

```

Response:

```

{
    "jsonrpc": "2.0",
    "result": {
        "hostids": [
            "10092"
        ]
    },
    "id": 1
}

```

See also

- [Group link](#)
- [Group prototype](#)
- [Host prototype tag](#)
- [Custom interface](#)
- [User macro](#)

Source

`CHostPrototype::update()` in `ui/include/classes/api/services/CHostPrototype.php`.

Housekeeping

This class is designed to work with housekeeping.

Object references:

- [Housekeeping](#)

Available methods:

- [housekeeping.get](#) - retrieve housekeeping
- [housekeeping.update](#) - update housekeeping

Housekeeping object

The following objects are directly related to the housekeeping API.

Housekeeping

The settings object has the following properties.

Property	Type	Description
<code>hk_events_mode</code>	integer	Enable internal housekeeping for events and alerts. Possible values: 0 - Disable; 1 - <i>(default)</i> Enable.
<code>hk_events_trigger</code>	string	Trigger data storage period. Accepts seconds and time unit with suffix. Default: 365d.

Property	Type	Description
hk_events_service	string	Service data storage period. Accepts seconds and time unit with suffix. Default: 1d.
hk_events_internal	string	Internal data storage period. Accepts seconds and time unit with suffix. Default: 1d.
hk_events_discovery	string	Network discovery data storage period. Accepts seconds and time unit with suffix. Default: 1d.
hk_events_autoreg	string	Autoregistration data storage period. Accepts seconds and time unit with suffix. Default: 1d.
hk_services_mode	integer	Enable internal housekeeping for services. Possible values: 0 - Disable; 1 - (<i>default</i>) Enable.
hk_services	string	Services data storage period. Accepts seconds and time unit with suffix. Default: 365d.
hk_audit_mode	integer	Enable internal housekeeping for audit. Possible values: 0 - Disable; 1 - (<i>default</i>) Enable.
hk_audit	string	Audit data storage period. Accepts seconds and time unit with suffix. Default: 31d.
hk_sessions_mode	integer	Enable internal housekeeping for sessions. Possible values: 0 - Disable; 1 - (<i>default</i>) Enable.
hk_sessions	string	Sessions data storage period. Accepts seconds and time unit with suffix. Default: 365d.
hk_history_mode	integer	Enable internal housekeeping for history. Possible values: 0 - Disable; 1 - (<i>default</i>) Enable.
hk_history_global	integer	Override item history period. Possible values: 0 - Do not override; 1 - (<i>default</i>) Override.
hk_history	string	History data storage period. Accepts seconds and time unit with suffix. Default: 31d.
hk_trends_mode	integer	Enable internal housekeeping for trends. Possible values: 0 - Disable; 1 - (<i>default</i>) Enable.

Property	Type	Description
hk_trends_global	integer	Override item trend period.
hk_trends	string	<p>Possible values: 0 - Do not override; 1 - <i>(default)</i> Override.</p> <p>Trends data storage period. Accepts seconds and time unit with suffix.</p>
db_extension	string	<p>Default: 365d.</p> <p>Configuration flag DB extension. If this flag is set to "timescaledb" then the server changes its behavior for housekeeping and item deletion.</p>
compression_availability	integer	<p>Property behavior: - <i>read-only</i></p> <p>Whether data compression is supported by the database (or its extension).</p> <p>Possible values: 0 - Unavailable; 1 - Available.</p>
compression_status	integer	<p>Property behavior: - <i>read-only</i></p> <p>Enable TimescaleDB compression for history and trends.</p> <p>Possible values: 0 - <i>(default)</i> Off; 1 - On.</p>
compress_older	string	<p>Compress history and trends records older than specified period. Accepts seconds and time unit with suffix.</p> <p>Default: 7d.</p>

housekeeping.get

Description

`object housekeeping.get(object parameters)`

The method allows to retrieve housekeeping object according to the given parameters.

Note:

This method is available to users of any type. Permissions to call the method can be revoked in user role settings. See [User roles](#) for more information.

Parameters

(object) Parameters defining the desired output.

The method supports only one parameter.

Parameter	Type	Description
output	query	This parameter being common for all get methods described in the reference commentary .

Return values

(object) Returns housekeeping object.

Examples

Request:

```
{
  "jsonrpc": "2.0",
  "method": "housekeeping.get",
  "params": {
    "output": "extend"
  },
  "id": 1
}
```

Response:

```
{
  "jsonrpc": "2.0",
  "result": {
    "hk_events_mode": "1",
    "hk_events_trigger": "365d",
    "hk_events_service": "1d",
    "hk_events_internal": "1d",
    "hk_events_discovery": "1d",
    "hk_events_autoreg": "1d",
    "hk_services_mode": "1",
    "hk_services": "365d",
    "hk_audit_mode": "1",
    "hk_audit": "31d",
    "hk_sessions_mode": "1",
    "hk_sessions": "365d",
    "hk_history_mode": "1",
    "hk_history_global": "0",
    "hk_history": "31d",
    "hk_trends_mode": "1",
    "hk_trends_global": "0",
    "hk_trends": "365d",
    "db_extension": "",
    "compression_status": "0",
    "compress_older": "7d"
  },
  "id": 1
}
```

Source

CHousekeeping ::get() in `ui/include/classes/api/services/CHousekeeping.php`.

housekeeping.update

Description

object housekeeping.update(object housekeeping)

This method allows to update existing housekeeping settings.

Note:

This method is only available to *Super admin* user type. Permissions to call the method can be revoked in user role settings. See [User roles](#) for more information.

Parameters

(object) **Housekeeping properties** to be updated.

Return values

(array) Returns an array with the names of updated parameters.

Examples

Request:

```

{
  "jsonrpc": "2.0",
  "method": "housekeeping.update",
  "params": {
    "hk_events_mode": "1",
    "hk_events_trigger": "200d",
    "hk_events_internal": "2d",
    "hk_events_discovery": "2d"
  },
  "id": 1
}

```

Response:

```

{
  "jsonrpc": "2.0",
  "result": [
    "hk_events_mode",
    "hk_events_trigger",
    "hk_events_internal",
    "hk_events_discovery"
  ],
  "id": 1
}

```

Source

CHousekeeping::update() in *ui/include/classes/api/services/CHousekeeping.php*.

Icon map

This class is designed to work with icon maps.

Object references:

- [Icon map](#)
- [Icon mapping](#)

Available methods:

- [iconmap.create](#) - create new icon maps
- [iconmap.delete](#) - delete icon maps
- [iconmap.get](#) - retrieve icon maps
- [iconmap.update](#) - update icon maps

Icon map object

The following objects are directly related to the `iconmap` API.

Icon map

The icon map object has the following properties.

Property	Type	Description
<code>iconmapid</code>	ID	ID of the icon map. Property behavior: - <i>read-only</i> - <i>required</i> for update operations
<code>default_iconid</code>	ID	ID of the default icon. Property behavior: - <i>required</i> for create operations

Property	Type	Description
name	string	Name of the icon map.
Property behavior: - <i>required</i> for create operations		

Icon mapping

The icon mapping object defines a specific icon to be used for hosts with a certain inventory field value. It has the following properties.

Property	Type	Description
iconid	ID	ID of the icon used by the icon mapping.
Property behavior: - <i>required</i>		
expression	string	Expression to match the inventory field against.
Property behavior: - <i>required</i>		
inventory_link	integer	ID of the host inventory field.
Refer to the host inventory object for a list of supported inventory fields.		
Property behavior: - <i>required</i>		
sortorder	integer	Position of the icon mapping in the icon map.
Property behavior: - <i>read-only</i>		

iconmap.create

Description

object iconmap.create(object/array iconMaps)

This method allows to create new icon maps.

Note:

This method is only available to *Super admin* user type. Permissions to call the method can be revoked in user role settings. See **User roles** for more information.

Parameters

(object/array) Icon maps to create.

Additionally to the **standard icon map properties**, the method accepts the following parameters.

Parameter	Type	Description
mappings	array	Icon mappings to be created for the icon map.
Parameter behavior: - <i>required</i>		

Return values

(object) Returns an object containing the IDs of the created icon maps under the `iconmapids` property. The order of the returned IDs matches the order of the passed icon maps.

Examples

Create an icon map

Create an icon map to display hosts of different types.

Request:

```
{
  "jsonrpc": "2.0",
  "method": "iconmap.create",
  "params": {
    "name": "Type icons",
    "default_iconid": "2",
    "mappings": [
      {
        "inventory_link": 1,
        "expression": "server",
        "iconid": "3"
      },
      {
        "inventory_link": 1,
        "expression": "switch",
        "iconid": "4"
      }
    ]
  },
  "id": 1
}
```

Response:

```
{
  "jsonrpc": "2.0",
  "result": {
    "iconmapids": [
      "2"
    ]
  },
  "id": 1
}
```

See also

- [Icon mapping](#)

Source

ClconMap::create() in `ui/include/classes/api/services/ClconMap.php`.

iconmap.delete

Description

object iconmap.delete(array iconMapIds)

This method allows to delete icon maps.

Note:

This method is only available to *Super admin* user type. Permissions to call the method can be revoked in user role settings. See [User roles](#) for more information.

Parameters

(array) IDs of the icon maps to delete.

Return values

(object) Returns an object containing the IDs of the deleted icon maps under the `iconmapids` property.

Examples

Delete multiple icon maps

Delete two icon maps.

Request:

```
{
  "jsonrpc": "2.0",
  "method": "iconmap.delete",
  "params": [
    "2",
    "5"
  ],
  "id": 1
}
```

Response:

```
{
  "jsonrpc": "2.0",
  "result": {
    "iconmapids": [
      "2",
      "5"
    ]
  },
  "id": 1
}
```

Source

`ClconMap::delete()` in `ui/include/classes/api/services/ClconMap.php`.

iconmap.get

Description

`integer/array iconmap.get(object parameters)`

The method allows to retrieve icon maps according to the given parameters.

Note:

This method is available to users of any type. Permissions to call the method can be revoked in user role settings. See [User roles](#) for more information.

Parameters

(object) Parameters defining the desired output.

The method supports the following parameters.

Parameter	Type	Description
iconmapids	ID/array	Return only icon maps with the given IDs.
sysmapids	ID/array	Return only icon maps that are used in the given maps.
selectMappings	query	Return a mappings property with the icon mappings used.
sortfield	string/array	Sort the result by the given properties.
countOutput	boolean	Possible values: <code>iconmapid</code> , <code>name</code> . These parameters being common for all get methods are described in detail in the reference commentary .
editable	boolean	
excludeSearch	boolean	
filter	object	
limit	integer	
output	query	
preservekeys	boolean	
search	object	

Parameter	Type	Description
searchByAny	boolean	
searchWildcardsEnabled	boolean	
sortorder	string/array	
startSearch	boolean	

Return values

(integer/array) Returns either:

- an array of objects;
- the count of retrieved objects, if the `countOutput` parameter has been used.

Examples

Retrieve an icon map

Retrieve all data about icon map "3".

Request:

```
{
  "jsonrpc": "2.0",
  "method": "iconmap.get",
  "params": {
    "iconmapids": "3",
    "output": "extend",
    "selectMappings": "extend"
  },
  "id": 1
}
```

Response:

```
{
  "jsonrpc": "2.0",
  "result": [
    {
      "mappings": [
        {
          "iconmappingid": "3",
          "iconmapid": "3",
          "iconid": "6",
          "inventory_link": "1",
          "expression": "server",
          "sortorder": "0"
        },
        {
          "iconmappingid": "4",
          "iconmapid": "3",
          "iconid": "10",
          "inventory_link": "1",
          "expression": "switch",
          "sortorder": "1"
        }
      ],
      "iconmapid": "3",
      "name": "Host type icons",
      "default_iconid": "2"
    }
  ],
  "id": 1
}
```

See also

- [Icon mapping](#)

Source

ClconMap::get() in `ui/include/classes/api/services/ClconMap.php`.

iconmap.update

Description

object iconmap.update(object/array iconMaps)

This method allows to update existing icon maps.

Note:

This method is only available to *Super admin* user type. Permissions to call the method can be revoked in user role settings. See [User roles](#) for more information.

Parameters

(object/array) Icon map properties to be updated.

The `iconmapid` property must be defined for each icon map, all other properties are optional. Only the passed properties will be updated, all others will remain unchanged.

Additionally to the [standard icon map properties](#), the method accepts the following parameters.

Parameter	Type	Description
mappings	array	Icon mappings to replace the existing icon mappings.

Return values

(object) Returns an object containing the IDs of the updated icon maps under the `iconmapids` property.

Examples

Rename icon map

Rename an icon map to "OS icons".

Request:

```
{
  "jsonrpc": "2.0",
  "method": "iconmap.update",
  "params": {
    "iconmapid": "1",
    "name": "OS icons"
  },
  "id": 1
}
```

Response:

```
{
  "jsonrpc": "2.0",
  "result": {
    "iconmapids": [
      "1"
    ]
  },
  "id": 1
}
```

See also

- [Icon mapping](#)

Source

ClconMap::update() in `ui/include/classes/api/services/ClconMap.php`.

Image

This class is designed to work with images.

Object references:

- [Image](#)

Available methods:

- [image.create](#) - create new images
- [image.delete](#) - delete images
- [image.get](#) - retrieve images
- [image.update](#) - update images

Image object

The following objects are directly related to the `image` API.

Image

The image object has the following properties.

Property	Type	Description
imageid	ID	ID of the image. Property behavior: - <i>read-only</i>
name	string	- <i>required</i> for update operations Name of the image. Property behavior: - <i>required</i> for create operations
imagetype	integer	Type of image. Possible values: 1 - (<i>default</i>) icon; 2 - background image. Property behavior: - <i>constant</i>
image	string	- <i>required</i> for create operations Base64 encoded image. The maximum size of the encoded image is 1 MB. Maximum size can be adjusted by changing <code>ZBX_MAX_IMAGE_SIZE</code> constant value. Supported image formats: PNG, JPEG, GIF. Property behavior: - <i>required</i> for create operations

image.create

Description

```
object image.create(object/array images)
```

This method allows to create new images.

Note:

This method is only available to *Super admin* user type. Permissions to call the method can be revoked in user role settings. See [User roles](#) for more information.

Parameters

(object/array) Images to create.

The method accepts images with the **standard image properties**.

Return values

(object) Returns an object containing the IDs of the created images under the `imageids` property. The order of the returned IDs matches the order of the passed images.

Examples

Create an image

Create a cloud icon.

Request:

```
{
  "jsonrpc": "2.0",
  "method": "image.create",
  "params": {
    "imagetype": 1,
    "name": "Cloud_(24)",
    "image": "iVBORwOKGgoAAAANSUhEUgAAABgAAAANCAYAAACzbK7QAAAABHNCSVQICAgIfAhkiAAAAAlwSFlzAAACmAAAAPgE
  },
  "id": 1
}
```

Response:

```
{
  "jsonrpc": "2.0",
  "result": {
    "imageids": [
      "188"
    ]
  },
  "id": 1
}
```

Source

`CIImage::create()` in `ui/include/classes/api/services/CIImage.php`.

image.delete

Description

object `image.delete(array imageIds)`

This method allows to delete images.

Note:

This method is only available to *Super admin* user type. Permissions to call the method can be revoked in user role settings. See **User roles** for more information.

Parameters

(array) IDs of the images to delete.

Return values

(object) Returns an object containing the IDs of the deleted images under the `imageids` property.

Examples

Delete multiple images

Delete two images.

Request:

```
{
  "jsonrpc": "2.0",
  "method": "image.delete",
  "params": [
    "188",
    "192"
  ],
  "id": 1
}
```

Response:

```
{
  "jsonrpc": "2.0",
  "result": {
    "imageids": [
      "188",
      "192"
    ]
  },
  "id": 1
}
```

Source

CImage::delete() in *ui/include/classes/api/services/CImage.php*.

image.get

Description

integer/array image.get(object parameters)

The method allows to retrieve images according to the given parameters.

Note:

This method is available to users of any type. Permissions to call the method can be revoked in user role settings. See [User roles](#) for more information.

Parameters

(object) Parameters defining the desired output.

The method supports the following parameters.

Parameter	Type	Description
imageids	ID/array	Return only images with the given IDs.
sysmapids	ID/array	Return images that are used on the given maps.
select_image	flag	Return an <code>image</code> property with the Base64 encoded image.
sortfield	string/array	Sort the result by the given properties.
countOutput	boolean	Possible values: <code>imageid</code> , <code>name</code> . These parameters being common for all get methods are described in detail in the reference commentary .
editable	boolean	
excludeSearch	boolean	
filter	object	
limit	integer	
output	query	
preservekeys	boolean	
search	object	
searchByAny	boolean	
searchWildcardsEnabled	boolean	
sortorder	string/array	

Parameter	Type	Description
startSearch	boolean	

Return values

(integer/array) Returns either:

- an array of objects;
- the count of retrieved objects, if the `countOutput` parameter has been used.

Examples

Retrieve an image

Retrieve all data for image with ID "2".

Request:

```
{
  "jsonrpc": "2.0",
  "method": "image.get",
  "params": {
    "output": "extend",
    "select_image": true,
    "imageids": "2"
  },
  "id": 1
}
```

Response:

```
{
  "jsonrpc": "2.0",
  "result": [
    {
      "imageid": "2",
      "imagetype": "1",
      "name": "Cloud_(24)",
      "image": "iVBORwOKGgoAAAANSUHEUgAAABgAAAANCAyAAACzbK7QAAAABHNCSVQICAgIfAhkiAAAAAlwSFlzAAACmAA"
    }
  ],
  "id": 1
}
```

Source

`CIImage::get()` in `ui/include/classes/api/services/CIImage.php`.

image.update

Description

object `image.update(object/array images)`

This method allows to update existing images.

Note:

This method is only available to *Super admin* user type. Permissions to call the method can be revoked in user role settings. See [User roles](#) for more information.

Parameters

(object/array) Image properties to be updated.

The `imageid` property must be defined for each image, all other properties are optional. Only the passed properties will be updated, all others will remain unchanged.

The method accepts images with the [standard image properties](#).

Return values

(object) Returns an object containing the IDs of the updated images under the `imageids` property.

Examples

Rename image

Rename image to "Cloud icon".

Request:

```
{
  "jsonrpc": "2.0",
  "method": "image.update",
  "params": {
    "imageid": "2",
    "name": "Cloud icon"
  },
  "id": 1
}
```

Response:

```
{
  "jsonrpc": "2.0",
  "result": {
    "imageids": [
      "2"
    ]
  },
  "id": 1
}
```

Source

`Clmage::update()` in `ui/include/classes/api/services/Clmage.php`.

Item

This class is designed to work with items.

Object references:

- [Item](#)
- [Item tag](#)
- [Item preprocessing](#)

Available methods:

- [item.create](#) - create new items
- [item.delete](#) - delete items
- [item.get](#) - retrieve items
- [item.update](#) - update items

Item object

The following objects are directly related to the `item` API.

Item

Note:

Web items cannot be directly created, updated or deleted via the Zabbix API.

The item object has the following properties.

Property	Type	Description
itemid	ID	ID of the item.
delay	string	<p>Property behavior:</p> <ul style="list-style-type: none"> - <i>read-only</i> - <i>required</i> for update operations <p>Update interval of the item.</p> <p>Accepts seconds or time unit with suffix (e.g., 30s, 1m, 2h, 1d) and, optionally, one or more custom intervals, all separated by semicolons. Custom intervals can be a mix of flexible and scheduling intervals.</p> <p>Accepts user macros. If used, the value must be a single macro. Multiple macros or macros mixed with text are not supported. Flexible intervals may be written as two macros separated by a forward slash (e.g., <code>{FLEX_INTERVAL}/{FLEX_PERIOD}</code>).</p> <p>Example: <code>1h;wd1-5h9-18;{Macro1}/1-7,00:00-24:00;0/6-7,12:00-24:00;{Macro2}</code></p> <p>Property behavior:</p> <ul style="list-style-type: none"> - <i>required</i> if <code>type</code> is set to "Zabbix agent" (0), "Simple check" (3), "Zabbix internal" (5), "External check" (10), "Database monitor" (11), "IPMI agent" (12), "SSH agent" (13), "TELNET agent" (14), "Calculated" (15), "JMX agent" (16), "HTTP agent" (19), "SNMP agent" (20), "Script" (21), "Browser" (22), or if <code>type</code> is set to "Zabbix agent (active)" (7) and <code>key_</code> does not contain "mqtt.get"
hostid	ID	ID of the host or template that the item belongs to.
interfaceid	ID	<p>Property behavior:</p> <ul style="list-style-type: none"> - <i>constant</i> - <i>required</i> for create operations <p>ID of the item's host interface.</p> <p>Property behavior:</p> <ul style="list-style-type: none"> - <i>required</i> if item belongs to host and <code>type</code> is set to "Zabbix agent", "IPMI agent", "JMX agent", "SNMP trap", or "SNMP agent" - <i>supported</i> if item belongs to host and <code>type</code> is set to "Simple check", "External check", "SSH agent", "TELNET agent", or "HTTP agent" - <i>read-only</i> for discovered objects
key_	string	<p>Item key.</p> <p>Property behavior:</p> <ul style="list-style-type: none"> - <i>required</i> for create operations - <i>read-only</i> for inherited objects or discovered objects
name	string	<p>Name of the item.</p> <p>Supports user macros.</p> <p>Property behavior:</p> <ul style="list-style-type: none"> - <i>required</i> for create operations - <i>read-only</i> for inherited objects or discovered objects
name_resolved	string	<p>Name of the item with resolved user macros.</p> <p>Property behavior:</p> <ul style="list-style-type: none"> - <i>read-only</i>

Property	Type	Description
type	integer	Type of the item. Possible values: 0 - Zabbix agent; 2 - Zabbix trapper; 3 - Simple check; 5 - Zabbix internal; 7 - Zabbix agent (active); 9 - Web item; 10 - External check; 11 - Database monitor; 12 - IPMI agent; 13 - SSH agent; 14 - TELNET agent; 15 - Calculated; 16 - JMX agent; 17 - SNMP trap; 18 - Dependent item; 19 - HTTP agent; 20 - SNMP agent; 21 - Script; 22 - Browser. Property behavior: - <i>required</i> for create operations - <i>read-only</i> for inherited objects or discovered objects
url	string	URL string. Supports user macros, {HOST.IP}, {HOST.CONN}, {HOST.DNS}, {HOST.HOST}, {HOST.NAME}, {HOST.PORT}, {ITEM.ID}, {ITEM.KEY}. Property behavior: - <i>required</i> if type is set to "HTTP agent" - <i>read-only</i> for inherited objects or discovered objects
value_type	integer	Type of information of the item. Possible values: 0 - numeric float; 1 - character; 2 - log; 3 - numeric unsigned; 4 - text; 5 - binary. Property behavior: - <i>required</i> for create operations - <i>read-only</i> for inherited objects or discovered objects
allow_traps	integer	Allow to populate value similarly to the trapper item. 0 - (<i>default</i>) Do not allow to accept incoming data; 1 - Allow to accept incoming data. Property behavior: - <i>supported</i> if type is set to "HTTP agent" - <i>read-only</i> for discovered objects

Property	Type	Description
authtype	integer	<p>Authentication method.</p> <p>Possible values if type is set to "SSH agent": 0 - (<i>default</i>) password; 1 - public key.</p> <p>Possible values if type is set to "HTTP agent": 0 - (<i>default</i>) none; 1 - basic; 2 - NTLM; 3 - Kerberos.</p> <p>Property behavior: - <i>supported</i> if type is set to "SSH agent" or "HTTP agent" - <i>read-only</i> for inherited objects (if type is set to "HTTP agent") or discovered objects</p>
description	string	<p>Description of the item.</p> <p>Property behavior: - <i>read-only</i> for discovered objects</p>
error	string	<p>Error text if there are problems updating the item value.</p> <p>Property behavior: - <i>read-only</i></p>
flags	integer	<p>Origin of the item.</p> <p>Possible values: 0 - a plain item; 4 - a discovered item.</p> <p>Property behavior: - <i>read-only</i></p>
follow_redirects	integer	<p>Follow response redirects while polling data.</p> <p>Possible values: 0 - Do not follow redirects; 1 - (<i>default</i>) Follow redirects.</p> <p>Property behavior: - <i>supported</i> if type is set to "HTTP agent" - <i>read-only</i> for inherited objects or discovered objects</p>
headers	array	<p>Array of headers that will be sent when performing an HTTP request.</p> <p>Property behavior: - <i>supported</i> if type is set to "HTTP agent" - <i>read-only</i> for inherited objects or discovered objects</p>
history	string	<p>A time unit of how long the history data should be stored. Also accepts user macro.</p> <p>Default: 31d.</p> <p>Property behavior: - <i>read-only</i> for discovered objects</p>
http_proxy	string	<p>HTTP(S) proxy connection string.</p> <p>Property behavior: - <i>supported</i> if type is set to "HTTP agent" - <i>read-only</i> for inherited objects or discovered objects</p>

Property	Type	Description
inventory_link	integer	<p>ID of the host inventory field that is populated by the item.</p> <p>Refer to the host inventory page for a list of supported host inventory fields and their IDs.</p> <p>Default: 0.</p> <p>Property behavior:</p> <ul style="list-style-type: none"> - <i>supported</i> if <code>value_type</code> is set to "numeric float", "character", "numeric unsigned", or "text" - <i>read-only</i> for discovered objects
ipmi_sensor	string	<p>IPMI sensor.</p> <p>Property behavior:</p> <ul style="list-style-type: none"> - <i>required</i> if <code>type</code> is set to "IPMI agent" and <code>key_</code> is not set to "ipmi.get" - <i>supported</i> if <code>type</code> is set to "IPMI agent" - <i>read-only</i> for inherited objects or discovered objects
jmx_endpoint	string	<p>JMX agent custom connection string.</p> <p>Default value: <code>service:jmx:rmi:///jndi/rmi://{HOST.CONN}:{HOST.PORT}/jmxrmi</code></p> <p>Property behavior:</p> <ul style="list-style-type: none"> - <i>supported</i> if <code>type</code> is set to "JMX agent" - <i>read-only</i> for discovered objects
lastclock	timestamp	<p>Time when the item value was last updated.</p> <p>By default, only values that fall within the last 24 hours are displayed. You can extend this time period by changing the value of <i>Max history display period</i> parameter in the Administration → General menu section.</p> <p>Property behavior:</p> <ul style="list-style-type: none"> - <i>read-only</i>
lastns	integer	<p>Nanoseconds when the item value was last updated.</p> <p>By default, only values that fall within the last 24 hours are displayed. You can extend this time period by changing the value of <i>Max history display period</i> parameter in the Administration → General menu section.</p> <p>Property behavior:</p> <ul style="list-style-type: none"> - <i>read-only</i>
lastvalue	string	<p>Last value of the item.</p> <p>By default, only values that fall within the last 24 hours are displayed. You can extend this time period by changing the value of <i>Max history display period</i> parameter in the Administration → General menu section.</p> <p>Property behavior:</p> <ul style="list-style-type: none"> - <i>read-only</i>
logtimefmt	string	<p>Format of the time in log entries.</p> <p>Property behavior:</p> <ul style="list-style-type: none"> - <i>supported</i> if <code>value_type</code> is set to "log" - <i>read-only</i> for inherited objects or discovered objects

Property	Type	Description
master_itemid	ID	ID of the master item.
output_format	integer	<p>Property behavior:</p> <ul style="list-style-type: none"> - <i>required</i> if type is set to "Dependent item" - <i>read-only</i> for inherited objects or discovered objects <p>Should the response be converted to JSON.</p> <p>0 - (<i>default</i>) Store raw; 1 - Convert to JSON.</p>
params	string	<p>Property behavior:</p> <ul style="list-style-type: none"> - <i>supported</i> if type is set to "HTTP agent" - <i>read-only</i> for inherited objects or discovered objects <p>Additional parameters depending on the type of the item:</p> <ul style="list-style-type: none"> - executed script for SSH agent and TELNET agent items; - SQL query for database monitor items; - formula for calculated items; - the script for script and browser items.
parameters	object/array	<p>Property behavior:</p> <ul style="list-style-type: none"> - <i>required</i> if type is set to "Database monitor", "SSH agent", "TELNET agent", "Calculated", "Script", or "Browser" - <i>read-only</i> for inherited objects (if type is set to "Script" or "Browser") or discovered objects <p>Additional parameters if type is set to "Script" or "Browser". Array of objects with name and value properties, where name must be unique.</p>
password	string	<p>Property behavior:</p> <ul style="list-style-type: none"> - <i>supported</i> if type is set to "Script" or "Browser" - <i>read-only</i> for inherited objects or discovered objects <p>Password for authentication.</p>
post_type	integer	<p>Property behavior:</p> <ul style="list-style-type: none"> - <i>required</i> if type is set to "JMX agent" and username is set - <i>supported</i> if type is set to "Simple check", "SSH agent", "TELNET agent", "Database monitor", or "HTTP agent" - <i>read-only</i> for inherited objects (if type is set to "HTTP agent") or discovered objects <p>Type of post data body stored in posts property.</p> <p>Possible values: 0 - (<i>default</i>) Raw data; 2 - JSON data; 3 - XML data.</p>
posts	string	<p>Property behavior:</p> <ul style="list-style-type: none"> - <i>supported</i> if type is set to "HTTP agent" - <i>read-only</i> for inherited objects or discovered objects <p>HTTP(S) request body data.</p>
		<p>Property behavior:</p> <ul style="list-style-type: none"> - <i>required</i> if type is set to "HTTP agent" and post_type is set to "JSON data" or "XML data" - <i>supported</i> if type is set to "HTTP agent" and post_type is set to "Raw data" - <i>read-only</i> for inherited objects or discovered objects

Property	Type	Description
prevvalue	string	<p>Previous value of the item.</p> <p>By default, only values that fall within the last 24 hours are displayed. You can extend this time period by changing the value of <i>Max history display period</i> parameter in the <i>Administration → General</i> menu section.</p>
privatekey	string	<p>Property behavior: - <i>read-only</i> Name of the private key file.</p>
publickey	string	<p>Property behavior: - <i>required</i> if type is set to "SSH agent" and authtype is set to "public key" - <i>read-only</i> for discovered objects Name of the public key file.</p>
query_fields	array	<p>Property behavior: - <i>required</i> if type is set to "SSH agent" and authtype is set to "public key" - <i>read-only</i> for discovered objects Array of query fields that will be sent when performing an HTTP request.</p>
request_method	integer	<p>Property behavior: - <i>supported</i> if type is set to "HTTP agent" - <i>read-only</i> for inherited objects or discovered objects Type of request method.</p> <p>Possible values: 0 - (<i>default</i>) GET; 1 - POST; 2 - PUT; 3 - HEAD.</p>
retrieve_mode	integer	<p>Property behavior: - <i>supported</i> if type is set to "HTTP agent" - <i>read-only</i> for inherited objects or discovered objects What part of response should be stored.</p> <p>Possible values if request_method is set to "GET", "POST", or "PUT": 0 - (<i>default</i>) Body; 1 - Headers; 2 - Both body and headers will be stored.</p> <p>Possible values if request_method is set to "HEAD": 1 - Headers.</p>
snmp_oid	string	<p>Property behavior: - <i>supported</i> if type is set to "HTTP agent" - <i>read-only</i> for inherited objects or discovered objects SNMP OID.</p>
ssl_cert_file	string	<p>Property behavior: - <i>required</i> if type is set to "SNMP agent" - <i>read-only</i> for inherited objects or discovered objects Public SSL Key file path.</p> <p>Property behavior: - <i>supported</i> if type is set to "HTTP agent" - <i>read-only</i> for inherited objects or discovered objects</p>

Property	Type	Description
ssl_key_file	string	Private SSL Key file path.
ssl_key_password	string	<p>Property behavior:</p> <ul style="list-style-type: none"> - <i>supported</i> if type is set to "HTTP agent" - <i>read-only</i> for inherited objects or discovered objects Password for SSL Key file.
state	integer	<p>Property behavior:</p> <ul style="list-style-type: none"> - <i>supported</i> if type is set to "HTTP agent" - <i>read-only</i> for inherited objects or discovered objects State of the item. Possible values: <ul style="list-style-type: none"> 0 - (<i>default</i>) normal; 1 - not supported.
status	integer	<p>Property behavior:</p> <ul style="list-style-type: none"> - <i>read-only</i> Status of the item. Possible values: <ul style="list-style-type: none"> 0 - (<i>default</i>) enabled item; 1 - disabled item.
status_codes	string	Ranges of required HTTP status codes, separated by commas. Also supports user macros as part of comma separated list. Example: 200,200-{\$M},{M},200-400 <p>Property behavior:</p> <ul style="list-style-type: none"> - <i>supported</i> if type is set to "HTTP agent" - <i>read-only</i> for inherited objects or discovered objects
templateid	ID	ID of the parent template item. <i>Hint:</i> Use the <code>hostid</code> property to specify the template that the item belongs to. <p>Property behavior:</p> <ul style="list-style-type: none"> - <i>read-only</i>
timeout	string	Item data polling request timeout. Accepts seconds or time unit with suffix (e.g., 30s, 1m). Also accepts user macros. Possible values range: 1-600s. Default: "" - use proxy/global settings. <p>Property behavior:</p> <ul style="list-style-type: none"> - <i>supported</i> if type is set to "Zabbix agent" (0), "Simple check" (3) and <code>key_</code> does not start with "vmware." and "icmping", "Zabbix agent (active)" (7), "External check" (10), "Database monitor" (11), "SSH agent" (13), "TELNET agent" (14), "HTTP agent" (19), "SNMP agent" (20) and <code>snmp_oid</code> starts with "walk[" or "get[" , "Script" (21), "Browser" (22) - <i>read-only</i> for inherited and discovered objects
trapper_hosts	string	Allowed hosts. <p>Property behavior:</p> <ul style="list-style-type: none"> - <i>readonly</i> for discovered objects - <i>supported</i> if type is set to "Zabbix trapper", or if type is set to "HTTP agent" and <code>allow_traps</code> is set to "Allow to accept incoming data"

Property	Type	Description
trends	string	A time unit of how long the trends data should be stored. Also accepts user macro. Default: 365d. Property behavior: - <i>supported</i> if <code>value_type</code> is set to "numeric float" or "numeric unsigned" - <i>read-only</i> for discovered objects
units	string	Value units. Property behavior: - <i>supported</i> if <code>value_type</code> is set to "numeric float" or "numeric unsigned" - <i>read-only</i> for discovered objects
username	string	Username for authentication. Property behavior: - <i>required</i> if <code>type</code> is set to "SSH agent", "TELNET agent", or if <code>type</code> is set to "JMX agent" and <code>password</code> is set - <i>supported</i> if <code>type</code> is set to "Simple check", "Database monitor", or "HTTP agent" - <i>read-only</i> for inherited objects (if <code>type</code> is set to "HTTP agent") or discovered objects
uuid	string	Universal unique identifier, used for linking imported item to already existing ones. Auto-generated, if not given. Property behavior: - <i>supported</i> if the item belongs to a template
valuemapid	ID	ID of the associated value map. Property behavior: - <i>supported</i> if <code>value_type</code> is set to "numeric float", "character", or "numeric unsigned" - <i>read-only</i> for inherited objects or discovered objects
verify_host	integer	Whether to validate that the host name for the connection matches the one in the host's certificate. Possible values: 0 - (<i>default</i>) Do not validate; 1 - Validate. Property behavior: - <i>supported</i> if <code>type</code> is set to "HTTP agent" - <i>read-only</i> for inherited objects or discovered objects
verify_peer	integer	Whether to validate that the host's certificate is authentic. Possible values: 0 - (<i>default</i>) Do not validate; 1 - Validate. Property behavior: - <i>supported</i> if <code>type</code> is set to "HTTP agent" - <i>read-only</i> for inherited objects or discovered objects

HTTP header

The header object has the following properties:

Property	Type	Description
name	string	HTTP header name. Property behavior: - <i>required</i>
value	string	Header value. Property behavior: - <i>required</i>

HTTP query field

The query field object defines a name and value that is used to specify a URL parameter. It has the following properties:

Property	Type	Description
name	string	Name of the parameter. Property behavior: - <i>required</i>
value	string	Parameter value. Property behavior: - <i>required</i>

Item tag

The item tag object has the following properties.

Property	Type	Description
tag	string	Item tag name. Property behavior: - <i>required</i>
value	string	Item tag value.

Item preprocessing

The item preprocessing object has the following properties.

Property	Type	Description
type	integer	<p>The preprocessing option type.</p> <p>Possible values:</p> <ul style="list-style-type: none"> 1 - Custom multiplier; 2 - Right trim; 3 - Left trim; 4 - Trim; 5 - Regular expression; 6 - Boolean to decimal; 7 - Octal to decimal; 8 - Hexadecimal to decimal; 9 - Simple change; 10 - Change per second; 11 - XML XPath; 12 - JSONPath; 13 - In range; 14 - Matches regular expression; 15 - Does not match regular expression; 16 - Check for error in JSON; 17 - Check for error in XML; 18 - Check for error using regular expression; 19 - Discard unchanged; 20 - Discard unchanged with heartbeat; 21 - JavaScript; 22 - Prometheus pattern; 23 - Prometheus to JSON; 24 - CSV to JSON; 25 - Replace; 26 - Check unsupported; 27 - XML to JSON; 28 - SNMP walk value; 29 - SNMP walk to JSON; 30 - SNMP get value. <p>Property behavior:</p> <ul style="list-style-type: none"> - <i>required</i>
params	string	<p>Additional parameters used by preprocessing option. Multiple parameters are separated by the newline (\n) character.</p> <p>If type is set to "Check unsupported", the parameters follow a <scope>[\n<pattern>] syntax, where <i>pattern</i> is a regular expression, and <i>scope</i> is one of:</p> <ul style="list-style-type: none"> -1 - match any error; 0 - check if error message matches <i>pattern</i>; 1 - check if error message does not match <i>pattern</i>. <p>Property behavior:</p> <ul style="list-style-type: none"> - <i>required</i> if type is set to "Custom multiplier" (1), "Right trim" (2), "Left trim" (3), "Trim" (4), "Regular expression" (5), "XML XPath" (11), "JSONPath" (12), "In range" (13), "Matches regular expression" (14), "Does not match regular expression" (15), "Check for error in JSON" (16), "Check for error in XML" (17), "Check for error using regular expression" (18), "Discard unchanged with heartbeat" (20), "JavaScript" (21), "Prometheus pattern" (22), "Prometheus to JSON" (23), "CSV to JSON" (24), "Replace" (25), "Check unsupported" (26), "SNMP walk value" (28), "SNMP walk to JSON" (29), or "SNMP get value" (30)

Property	Type	Description
error_handler	integer	<p>Action type used in case of preprocessing step failure.</p> <p>Possible values:</p> <ul style="list-style-type: none"> 0 - Error message is set by Zabbix server; 1 - Discard value; 2 - Set custom value; 3 - Set custom error message. <p>Possible values if type is set to "Check unsupported":</p> <ul style="list-style-type: none"> 1 - Discard value; 2 - Set custom value; 3 - Set custom error message. <p>Property behavior:</p> <ul style="list-style-type: none"> - <i>required</i> if type is set to "Custom multiplier" (1), "Regular expression" (5), "Boolean to decimal" (6), "Octal to decimal" (7), "Hexadecimal to decimal" (8), "Simple change" (9), "Change per second" (10), "XML XPath" (11), "JSONPath" (12), "In range" (13), "Matches regular expression" (14), "Does not match regular expression" (15), "Check for error in JSON" (16), "Check for error in XML" (17), "Check for error using regular expression" (18), "Prometheus pattern" (22), "Prometheus to JSON" (23), "CSV to JSON" (24), "Check unsupported" (26), "XML to JSON" (27), "SNMP walk value" (28), "SNMP walk to JSON" (29), or "SNMP get value" (30)
error_handler_params	string	<p>Error handler parameters.</p> <p>Property behavior:</p> <ul style="list-style-type: none"> - <i>required</i> if error_handler is set to "Set custom value" or "Set custom error message"

The following parameters and error handlers are supported for each preprocessing type.

Preprocessing type	Name	Parameter 1	Parameter 2	Parameter 3	Supported error handlers
1	Custom multiplier	number ^{1,6}			0, 1, 2, 3
2	Right trim	list of characters ²			
3	Left trim	list of characters ²			
4	Trim	list of characters ²			
5	Regular expression	pattern ³	output ²		0, 1, 2, 3
6	Boolean to decimal				0, 1, 2, 3
7	Octal to decimal				0, 1, 2, 3
8	Hexadecimal to decimal				0, 1, 2, 3

Preprocessing type	Name	Parameter 1	Parameter 2	Parameter 3	Supported error handlers
9	Simple change				0, 1, 2, 3
10	Change per sec- ond				0, 1, 2, 3
11	XML XPath	path ⁴			0, 1, 2, 3
12	JSONPath	path ⁴			0, 1, 2, 3
13	In range	min ^{1, 6}	max ^{1, 6}		0, 1, 2, 3
14	Matches regu- lar ex- pres- sion	pattern ³			0, 1, 2, 3
15	Does not match regu- lar ex- pres- sion	pattern ³			0, 1, 2, 3
16	Check for error in JSON	path ⁴			0, 1, 2, 3
17	Check for error in XML	path ⁴			0, 1, 2, 3
18	Check for error us- ing regu- lar ex- pres- sion	pattern ³	output ²		0, 1, 2, 3
19	Discard un- changed				
20	Discard un- changed with heart- beat	seconds ^{5, 6}			
21	JavaScript	script ²			
22	Prometh- pat- tern	pattern ^{6, 7}	value, label, function	output ^{8, 9}	0, 1, 2, 3
23	Prometh- to JSON	pattern ^{6, 7}			0, 1, 2, 3

Preprocessing type	Name	Parameter 1	Parameter 2	Parameter 3	Supported error handlers
24	CSV to JSON	character ²	character ²	0,1	0, 1, 2, 3
25	Replace search string ²		replacement ²		
26	Check un- sup- ported	scope ¹	pattern ^{3, 6}		1, 2, 3
27	XML to JSON				0, 1, 2, 3
28	SNMP walk value	OID ²	Format: 0 - Unchanged 1 - UTF-8 from Hex-STRING 2 - MAC from Hex-STRING 3 - Integer from BITS		0, 1, 2, 3
29	SNMP walk to JSON ¹⁰	Field name ²	OID prefix ²	Format: 0 - Unchanged 1 - UTF-8 from Hex-STRING 2 - MAC from Hex-STRING 3 - Integer from BITS	0, 1, 2, 3
30	SNMP get value	Format: 1 - UTF-8 from Hex-STRING 2 - MAC from Hex-STRING 3 - Integer from BITS			0, 1, 2, 3

¹ integer or floating-point number

² string

³ regular expression

⁴ JSONPath or XML XPath

⁵ positive integer (with support of time suffixes, e.g. 30s, 1m, 2h, 1d)

⁶ user macro

⁷ Prometheus pattern following the syntax: `<metric name>{<label name>=<label value>, ...} == <value>`. Each Prometheus pattern component (metric, label name, label value and metric value) can be user macro.

⁸ Prometheus output following the syntax: `<label name>` (can be a user macro) if label is selected as the second parameter.

⁹ One of the aggregation functions: `sum`, `min`, `max`, `avg`, `count` if function is selected as the second parameter.

¹⁰ Supports multiple "Field name,OID prefix,Format records" records delimited by a new line character.

item.create

Description

`object item.create(object/array items)`

This method allows to create new items.

Note:

Web items cannot be created via the Zabbix API.

Note:

This method is only available to *Admin* and *Super admin* user types. Permissions to call the method can be revoked in user role settings. See [User roles](#) for more information.

Parameters

(object/array) Items to create.

Additionally to the [standard item properties](#), the method accepts the following parameters.

Parameter	Type	Description
preprocessing	array	Item preprocessing options.
tags	array	Item tags .

Return values

(object) Returns an object containing the IDs of the created items under the `itemids` property. The order of the returned IDs matches the order of the passed items.

Examples**Creating an item**

Create a numeric Zabbix agent item with 2 item tags to monitor free disk space on host with ID "30074".

Request:

```
{
  "jsonrpc": "2.0",
  "method": "item.create",
  "params": {
    "name": "Free disk space on /home/joe/",
    "key_": "vfs.fs.size[/home/joe/,free]",
    "hostid": "30074",
    "type": 0,
    "value_type": 3,
    "interfaceid": "30084",
    "tags": [
      {
        "tag": "component",
        "value": "storage"
      },
      {
        "tag": "equipment",
        "value": "workstation"
      }
    ],
    "delay": "30s"
  },
  "id": 1
}
```

Response:

```
{
  "jsonrpc": "2.0",
  "result": {
    "itemids": [
      "24758"
    ]
  },
  "id": 1
}
```

Creating a host inventory item

Create a Zabbix agent item to populate the host's "OS" inventory field.

Request:

```
{
  "jsonrpc": "2.0",
  "method": "item.create",
  "params": {
    "name": "uname",
    "key_": "system.uname",
    "hostid": "30021",
    "type": 0,
    "interfaceid": "30007",
    "value_type": 1,
    "delay": "10s",
    "inventory_link": 5
  },
  "id": 1
}
```

Response:

```
{
  "jsonrpc": "2.0",
  "result": {
    "itemids": [
      "24759"
    ]
  },
  "id": 1
}
```

Creating an item with preprocessing

Create an item using custom multiplier.

Request:

```
{
  "jsonrpc": "2.0",
  "method": "item.create",
  "params": {
    "name": "Device uptime",
    "key_": "sysUpTime",
    "hostid": "11312",
    "type": 4,
    "snmp_oid": "SNMPv2-MIB::sysUpTime.0",
    "value_type": 1,
    "delay": "60s",
    "units": "uptime",
    "interfaceid": "1156",
    "preprocessing": [
      {
        "type": 1,
        "params": "0.01",
        "error_handler": 1,
        "error_handler_params": ""
      }
    ]
  },
  "id": 1
}
```

Response:

```
{
  "jsonrpc": "2.0",
  "result": {
    "itemids": [
```

```
        "44210"
    ]
},
"id": 1
}
```

Creating dependent item

Create a dependent item for the master item with ID 24759. Only dependencies on the same host are allowed, therefore master and the dependent item should have the same hostid.

Request:

```
{
  "jsonrpc": "2.0",
  "method": "item.create",
  "params": {
    "hostid": "30074",
    "name": "Dependent test item",
    "key_": "dependent.item",
    "type": 18,
    "master_itemid": "24759",
    "value_type": 2
  },
  "id": 1
}
```

Response:

```
{
  "jsonrpc": "2.0",
  "result": {
    "itemids": [
      "44211"
    ]
  },
  "id": 1
}
```

Create HTTP agent item

Create POST request method item with JSON response preprocessing.

Request:

```
{
  "jsonrpc": "2.0",
  "method": "item.create",
  "params": {
    "url": "http://127.0.0.1/http.php",
    "query_fields": [
      {
        "name": "mode",
        "value": "json"
      },
      {
        "name": "min",
        "value": "10"
      },
      {
        "name": "max",
        "value": "100"
      }
    ],
    "interfaceid": "1",
    "type": 19,
    "hostid": "10254",
  }
}
```

```

    "delay": "5s",
    "key_": "json",
    "name": "HTTP agent example JSON",
    "value_type": 0,
    "output_format": 1,
    "preprocessing": [
      {
        "type": 12,
        "params": "$.random",
        "error_handler": 0,
        "error_handler_params": ""
      }
    ]
  },
  "id": 1
}

```

Response:

```

{
  "jsonrpc": "2.0",
  "result": {
    "itemids": [
      "23865"
    ]
  },
  "id": 1
}

```

Create script item

Create a simple data collection using a script item.

Request:

```

{
  "jsonrpc": "2.0",
  "method": "item.create",
  "params": {
    "name": "Script example",
    "key_": "custom.script.item",
    "hostid": "12345",
    "type": 21,
    "value_type": 4,
    "params": "var request = new HttpRequest();\nreturn request.post(\"https://postman-echo.com/post\")",
    "parameters": [
      {
        "name": "host",
        "value": "{HOST.CONN}"
      }
    ]
  },
  "timeout": "6s",
  "delay": "30s"
},
  "id": 1
}

```

Response:

```

{
  "jsonrpc": "2.0",
  "result": {
    "itemids": [
      "23865"
    ]
  },
}

```



```
"id": 1
}
```

Source

CItem::create() in *ui/include/classes/api/services/CItem.php*.

item.delete

Description

object item.delete(array itemIds)

This method allows to delete items.

Note:

Web items cannot be deleted via the Zabbix API.

Note:

This method is only available to *Admin* and *Super admin* user types. Permissions to call the method can be revoked in user role settings. See [User roles](#) for more information.

Parameters

(array) IDs of the items to delete.

Return values

(object) Returns an object containing the IDs of the deleted items under the *itemids* property.

Examples

Deleting multiple items

Delete two items.

Dependent items and item prototypes are removed automatically if master item is deleted.

Request:

```
{
  "jsonrpc": "2.0",
  "method": "item.delete",
  "params": [
    "22982",
    "22986"
  ],
  "id": 1
}
```

Response:

```
{
  "jsonrpc": "2.0",
  "result": {
    "itemids": [
      "22982",
      "22986"
    ]
  },
  "id": 1
}
```

Source

CItem::delete() in *ui/include/classes/api/services/CItem.php*.

item.get

Description

integer/array item.get(object parameters)

The method allows to retrieve items according to the given parameters.

Note:

This method is available to users of any type. Permissions to call the method can be revoked in user role settings. See [User roles](#) for more information.

Parameters

(object) Parameters defining the desired output.

The method supports the following parameters.

Parameter	Type	Description
itemids	ID/array	Return only items with the given IDs.
groupids	ID/array	Return only items that belong to the hosts from the given groups.
templateids	ID/array	Return only items that belong to the given templates.
hostids	ID/array	Return only items that belong to the given hosts.
proxyids	ID/array	Return only items that are monitored by the given proxies.
interfaceids	ID/array	Return only items that use the given host interfaces.
graphids	ID/array	Return only items that are used in the given graphs.
triggerids	ID/array	Return only items that are used in the given triggers.
webitems	flag	Include web items in the result.
inherited	boolean	If set to true return only items inherited from a template.
templated	boolean	If set to true return only items that belong to templates.
monitored	boolean	If set to true return only enabled items that belong to monitored hosts.
group	string	Return only items that belong to a group with the given name.
host	string	Return only items that belong to a host with the given name.
evaltype	integer	Rules for tag searching. Possible values: 0 - (default) And/Or; 2 - Or.
tags	array	Return only items with given tags. Exact match by tag and case-sensitive or case-insensitive search by tag value depending on operator value. Format: [{"tag": "<tag>", "value": "<value>", "operator": "<operator>"}, ...]. An empty array returns all items. Possible operator types: 0 - (default) Like; 1 - Equal; 2 - Not like; 3 - Not equal; 4 - Exists; 5 - Not exists.
with_triggers	boolean	If set to true return only items that are used in triggers.
selectHosts	query	Return a hosts property with an array of hosts that the item belongs to.
selectInterfaces	query	Return an interfaces property with an array of host interfaces used by the item.
selectTriggers	query	Return a triggers property with the triggers that the item is used in.
selectGraphs	query	Supports count. Return a graphs property with the graphs that contain the item. Supports count.

Parameter	Type	Description
selectDiscoveryRule	query	Return a discoveryRule property with the LLD rule that created the item.
selectItemDiscovery	query	Return an itemDiscovery property with the item discovery object. The item discovery object links the item to an item prototype from which it was created. It has the following properties: itemdiscoveryid - (string) ID of the item discovery; itemid - (string) ID of the discovered item; parent_itemid - (string) ID of the item prototype from which the item has been created; key_ - (string) key of the item prototype; lastcheck - (timestamp) time when the item was last discovered; status - (int) item discovery status: 0 - (default) item is discovered, 1 - item is not discovered anymore; ts_delete - (timestamp) time when an item that is no longer discovered will be deleted; ts_disable - (timestamp) time when an item that is no longer discovered will be disabled; disable_source - (int) indicator of whether item was disabled by an LLD rule or manually: 0 - (default) disabled automatically, 1 - disabled by an LLD rule.
selectPreprocessing	query	Return a preprocessing property with item preprocessing options.
selectTags	query	Return the item tags in tags property.
selectValueMap	query	Return a valuemap property with item value map.
filter	object	Return only those results that exactly match the given filter. Accepts an object, where the keys are property names, and the values are either a single value or an array of values to match against. Does not support properties of text data type . Supports additional properties: host - technical name of the host that the item belongs to. Limits the number of records returned by subselects. Applies to the following subselects: selectGraphs - results will be sorted by name; selectTriggers - results will be sorted by description. Sort the result by the given properties. Possible values: itemid , name , key_ , delay , history , trends , type , status .
limitSelects	integer	These parameters being common for all get methods are described in detail in the reference commentary page.
sortfield	string/array	
countOutput	boolean	
editable	boolean	
excludeSearch	boolean	
limit	integer	
output	query	
preservekeys	boolean	
search	object	
searchByAny	boolean	
searchWildcardsEnabled	boolean	
sortorder	string/array	
startSearch	boolean	

Return values

(integer/array) Returns either:

- an array of objects;
- the count of retrieved objects, if the countOutput parameter has been used.

Examples

Finding items by key

Retrieve all items used in triggers for specific host ID that have word "system.cpu" in the item key and sort results by name.

Request:

```
{
  "jsonrpc": "2.0",
  "method": "item.get",
  "params": {
    "output": "extend",
    "hostids": "10084",
    "with_triggers": true,
    "search": {
      "key_": "system.cpu"
    },
    "sortfield": "name"
  },
  "id": 1
}
```

Response:

```
{
  "jsonrpc": "2.0",
  "result": [
    {
      "itemid": "42269",
      "type": "18",
      "snmp_oid": "",
      "hostid": "10084",
      "name": "CPU utilization",
      "key_": "system.cpu.util",
      "delay": "0",
      "history": "7d",
      "trends": "365d",
      "status": "0",
      "value_type": "0",
      "trapper_hosts": "",
      "units": "%",
      "logtimefmt": "",
      "templateid": "42267",
      "valuemapid": "0",
      "params": "",
      "ipmi_sensor": "",
      "authtype": "0",
      "username": "",
      "password": "",
      "publickey": "",
      "privatekey": "",
      "flags": "0",
      "interfaceid": "0",
      "description": "CPU utilization in %.",
      "inventory_link": "0",
      "evaltype": "0",
      "jmx_endpoint": "",
      "master_itemid": "42264",
      "timeout": "",
      "url": "",
      "query_fields": [],
      "posts": ""
    }
  ]
}
```

```

    "status_codes": "200",
    "follow_redirects": "1",
    "post_type": "0",
    "http_proxy": "",
    "headers": [],
    "retrieve_mode": "0",
    "request_method": "0",
    "output_format": "0",
    "ssl_cert_file": "",
    "ssl_key_file": "",
    "ssl_key_password": "",
    "verify_peer": "0",
    "verify_host": "0",
    "allow_traps": "0",
    "uuid": "",
    "state": "0",
    "error": "",
    "parameters": [],
    "lastclock": "0",
    "lastns": "0",
    "lastvalue": "0",
    "prevvalue": "0",
    "name_resolved": "CPU utilization"
  },
  {
    "itemid": "42259",
    "type": "0",
    "snmp_oid": "",
    "hostid": "10084",
    "name": "Load average (15m avg)",
    "key_": "system.cpu.load[all,avg15]",
    "delay": "1m",
    "history": "7d",
    "trends": "365d",
    "status": "0",
    "value_type": "0",
    "trapper_hosts": "",
    "units": "",
    "logtimefmt": "",
    "templateid": "42219",
    "valuemapid": "0",
    "params": "",
    "ipmi_sensor": "",
    "authtype": "0",
    "username": "",
    "password": "",
    "publickey": "",
    "privatekey": "",
    "flags": "0",
    "interfaceid": "1",
    "description": "",
    "inventory_link": "0",
    "evaltype": "0",
    "jmx_endpoint": "",
    "master_itemid": "0",
    "timeout": "",
    "url": "",
    "query_fields": [],
    "posts": "",
    "status_codes": "200",
    "follow_redirects": "1",
    "post_type": "0",

```

```

    "http_proxy": "",
    "headers": [],
    "retrieve_mode": "0",
    "request_method": "0",
    "output_format": "0",
    "ssl_cert_file": "",
    "ssl_key_file": "",
    "ssl_key_password": "",
    "verify_peer": "0",
    "verify_host": "0",
    "allow_traps": "0",
    "uuid": "",
    "state": "0",
    "error": "",
    "parameters": [],
    "lastclock": "0",
    "lastns": "0",
    "lastvalue": "0",
    "prevvalue": "0",
    "name_resolved": "Load average (15m avg)"
  },
  {
    "itemid": "42249",
    "type": "0",
    "snmp_oid": "",
    "hostid": "10084",
    "name": "Load average (1m avg)",
    "key_": "system.cpu.load[all,avg1]",
    "delay": "1m",
    "history": "7d",
    "trends": "365d",
    "status": "0",
    "value_type": "0",
    "trapper_hosts": "",
    "units": "",
    "logtimefmt": "",
    "templateid": "42209",
    "valuemapid": "0",
    "params": "",
    "ipmi_sensor": "",
    "authtype": "0",
    "username": "",
    "password": "",
    "publickey": "",
    "privatekey": "",
    "flags": "0",
    "interfaceid": "1",
    "description": "",
    "inventory_link": "0",
    "evaltype": "0",
    "jmx_endpoint": "",
    "master_itemid": "0",
    "timeout": "",
    "url": "",
    "query_fields": [],
    "posts": "",
    "status_codes": "200",
    "follow_redirects": "1",
    "post_type": "0",
    "http_proxy": "",
    "headers": [],
    "retrieve_mode": "0",

```

```

    "request_method": "0",
    "output_format": "0",
    "ssl_cert_file": "",
    "ssl_key_file": "",
    "ssl_key_password": "",
    "verify_peer": "0",
    "verify_host": "0",
    "allow_traps": "0",
    "uuid": "",
    "state": "0",
    "error": "",
    "parameters": [],
    "lastclock": "0",
    "lastns": "0",
    "lastvalue": "0",
    "prevvalue": "0",
    "name_resolved": "Load average (1m avg)"
  },
  {
    "itemid": "42257",
    "type": "0",
    "snmp_oid": "",
    "hostid": "10084",
    "name": "Load average (5m avg)",
    "key_": "system.cpu.load[all,avg5]",
    "delay": "1m",
    "history": "7d",
    "trends": "365d",
    "status": "0",
    "value_type": "0",
    "trapper_hosts": "",
    "units": "",
    "logtimefmt": "",
    "templateid": "42217",
    "valuemapid": "0",
    "params": "",
    "ipmi_sensor": "",
    "authtype": "0",
    "username": "",
    "password": "",
    "publickey": "",
    "privatekey": "",
    "flags": "0",
    "interfaceid": "1",
    "description": "",
    "inventory_link": "0",
    "evaltype": "0",
    "jmx_endpoint": "",
    "master_itemid": "0",
    "timeout": "",
    "url": "",
    "query_fields": [],
    "posts": "",
    "status_codes": "200",
    "follow_redirects": "1",
    "post_type": "0",
    "http_proxy": "",
    "headers": [],
    "retrieve_mode": "0",
    "request_method": "0",
    "output_format": "0",
    "ssl_cert_file": "",

```

```

    "ssl_key_file": "",
    "ssl_key_password": "",
    "verify_peer": "0",
    "verify_host": "0",
    "allow_traps": "0",
    "uuid": "",
    "state": "0",
    "error": "",
    "parameters": [],
    "lastclock": "0",
    "lastns": "0",
    "lastvalue": "0",
    "prevvalue": "0",
    "name_resolved": "Load average (5m avg)"
  },
  {
    "itemid": "42260",
    "type": "0",
    "snmp_oid": "",
    "hostid": "10084",
    "name": "Number of CPUs",
    "key_": "system.cpu.num",
    "delay": "1m",
    "history": "7d",
    "trends": "365d",
    "status": "0",
    "value_type": "3",
    "trapper_hosts": "",
    "units": "",
    "logtimefmt": "",
    "templateid": "42220",
    "valuemapid": "0",
    "params": "",
    "ipmi_sensor": "",
    "authtype": "0",
    "username": "",
    "password": "",
    "publickey": "",
    "privatekey": "",
    "flags": "0",
    "interfaceid": "1",
    "description": "",
    "inventory_link": "0",
    "evaltype": "0",
    "jmx_endpoint": "",
    "master_itemid": "0",
    "timeout": "",
    "url": "",
    "query_fields": [],
    "posts": "",
    "status_codes": "200",
    "follow_redirects": "1",
    "post_type": "0",
    "http_proxy": "",
    "headers": [],
    "retrieve_mode": "0",
    "request_method": "0",
    "output_format": "0",
    "ssl_cert_file": "",
    "ssl_key_file": "",
    "ssl_key_password": "",
    "verify_peer": "0",

```



```

        "verify_host": "0",
        "allow_traps": "0",
        "uuid": "",
        "state": "0",
        "error": "",
        "parameters": [],
        "lastclock": "0",
        "lastns": "0",
        "lastvalue": "0",
        "prevvalue": "0",
        "name_resolved": "Number of CPUs"
    }
],
    "id": 1
}

```

Finding dependent items by key

Retrieve all dependent items from host with ID "10116" that have the word "apache" in the key.

Request:

```

{
    "jsonrpc": "2.0",
    "method": "item.get",
    "params": {
        "output": "extend",
        "hostids": "10116",
        "search": {
            "key_": "apache"
        },
        "filter": {
            "type": 18
        }
    },
    "id": 1
}

```

Response:

```

{
    "jsonrpc": "2.0",
    "result": [
        {
            "itemid": "25550",
            "type": "18",
            "snmp_oid": "",
            "hostid": "10116",
            "name": "Days",
            "key_": "apache.status.uptime.days",
            "delay": "0",
            "history": "90d",
            "trends": "365d",
            "status": "0",
            "value_type": "3",
            "trapper_hosts": "",
            "units": "",
            "logtimefmt": "",
            "templateid": "0",
            "valuemapid": "0",
            "params": "",
            "ipmi_sensor": "",
            "authtype": "0",
            "username": "",
            "password": "",

```

```

    "publickey": "",
    "privatekey": "",
    "flags": "0",
    "interfaceid": "0",
    "description": "",
    "inventory_link": "0",
    "evaltype": "0",
    "jmx_endpoint": "",
    "master_itemid": "25545",
    "timeout": "",
    "url": "",
    "query_fields": [],
    "posts": "",
    "status_codes": "200",
    "follow_redirects": "1",
    "post_type": "0",
    "http_proxy": "",
    "headers": [],
    "retrieve_mode": "0",
    "request_method": "0",
    "output_format": "0",
    "ssl_cert_file": "",
    "ssl_key_file": "",
    "ssl_key_password": "",
    "verify_peer": "0",
    "verify_host": "0",
    "allow_traps": "0",
    "uuid": "",
    "state": "0",
    "error": "",
    "parameters": [],
    "lastclock": "0",
    "lastns": "0",
    "lastvalue": "0",
    "prevvalue": "0",
    "name_resolved": "Days"
  },
  {
    "itemid": "25555",
    "type": "18",
    "snmp_oid": "",
    "hostid": "10116",
    "name": "Hours",
    "key_": "apache.status.uptime.hours",
    "delay": "0",
    "history": "90d",
    "trends": "365d",
    "status": "0",
    "value_type": "3",
    "trapper_hosts": "",
    "units": "",
    "logtimefmt": "",
    "templateid": "0",
    "valuemapid": "0",
    "params": "",
    "ipmi_sensor": "",
    "authtype": "0",
    "username": "",
    "password": "",
    "publickey": "",
    "privatekey": "",
    "flags": "0",

```

```

    "interfaceid": "0",
    "description": "",
    "inventory_link": "0",
    "evaltype": "0",
    "jmx_endpoint": "",
    "master_itemid": "25545",
    "timeout": "",
    "url": "",
    "query_fields": [],
    "posts": "",
    "status_codes": "200",
    "follow_redirects": "1",
    "post_type": "0",
    "http_proxy": "",
    "headers": [],
    "retrieve_mode": "0",
    "request_method": "0",
    "output_format": "0",
    "ssl_cert_file": "",
    "ssl_key_file": "",
    "ssl_key_password": "",
    "verify_peer": "0",
    "verify_host": "0",
    "allow_traps": "0",
    "uuid": "",
    "state": "0",
    "error": "",
    "parameters": [],
    "lastclock": "0",
    "lastns": "0",
    "lastvalue": "0",
    "prevvalue": "0",
    "name_resolved": "Hours"
  }
],
  "id": 1
}

```

Find HTTP agent item

Find HTTP agent item with post body type XML for specific host ID.

Request:

```

{
  "jsonrpc": "2.0",
  "method": "item.get",
  "params": {
    "hostids": "10255",
    "filter": {
      "type": 19,
      "post_type": 3
    }
  }
},
  "id": 1
}

```

Response:

```

{
  "jsonrpc": "2.0",
  "result": [
    {
      "itemid": "28252",
      "type": "19",

```

```

"snmp_oid": "",
"hostid": "10255",
"name": "template item",
"key_": "ti",
"delay": "30s",
"history": "90d",
"trends": "365d",
"status": "0",
"value_type": "3",
"trapper_hosts": "",
"units": "",
"logtimefmt": "",
"templateid": "0",
"valuemapid": "0",
"params": "",
"ipmi_sensor": "",
"authtype": "0",
"username": "",
"password": "",
"publickey": "",
"privatekey": "",
"flags": "0",
"interfaceid": "0",
"description": "",
"inventory_link": "0",
"evaltype": "0",
"jmx_endpoint": "",
"master_itemid": "0",
"timeout": "",
"url": "localhost",
"query_fields": [
  {
    "name": "mode",
    "value": "xml"
  }
],
"posts": "<body>\r\n<![CDATA[{$MACRO}<foo></bar>]]>\r\n</body>",
"status_codes": "200",
"follow_redirects": "0",
"post_type": "3",
"http_proxy": "",
"headers": [],
"retrieve_mode": "1",
"request_method": "3",
"output_format": "0",
"ssl_cert_file": "",
"ssl_key_file": "",
"ssl_key_password": "",
"verify_peer": "0",
"verify_host": "0",
"allow_traps": "0",
"uuid": "",
"state": "0",
"error": "",
"parameters": [],
"lastclock": "0",
"lastns": "0",
"lastvalue": "",
"prevvalue": "",
"name_resolved": "template item"
}
],

```

```
"id": 1
}
```

Retrieving items with preprocessing rules

Retrieve all items and their preprocessing rules for specific host ID.

Request:

```
{
  "jsonrpc": "2.0",
  "method": "item.get",
  "params": {
    "output": ["itemid", "name", "key_"],
    "selectPreprocessing": "extend",
    "hostids": "10254"
  },
  "id": 1
}
```

Response:

```
{
  "jsonrpc": "2.0",
  "result": {
    "itemid": "23865",
    "name": "HTTP agent example JSON",
    "key_": "json",
    "preprocessing": [
      {
        "type": "12",
        "params": "$.random",
        "error_handler": "1",
        "error_handler_params": ""
      }
    ]
  },
  "id": 1
}
```

See also

- [Discovery rule](#)
- [Graph](#)
- [Host](#)
- [Host interface](#)
- [Trigger](#)

Source

`CItem::get()` in `ui/include/classes/api/services/CItem.php`.

item.update

Description

`object item.update(object/array items)`

This method allows to update existing items.

Note:

Web items cannot be updated via the Zabbix API.

Note:

This method is only available to *Admin* and *Super admin* user types. Permissions to call the method can be revoked in user role settings. See [User roles](#) for more information.

Parameters

(object/array) Item properties to be updated.

The `itemid` property must be defined for each item, all other properties are optional. Only the passed properties will be updated, all others will remain unchanged.

Additionally to the **standard item properties**, the method accepts the following parameters.

Parameter	Type	Description
<code>preprocessing</code>	array	Item preprocessing options to replace the current preprocessing options. Parameter behavior: - <i>read-only</i> for inherited objects or discovered objects
<code>tags</code>	array	Item tags . Parameter behavior: - <i>read-only</i> for discovered objects

Return values

(object) Returns an object containing the IDs of the updated items under the `itemids` property.

Examples

Enabling an item

Enable an item, that is, set its status to "0".

Request:

```
{
  "jsonrpc": "2.0",
  "method": "item.update",
  "params": {
    "itemid": "10092",
    "status": 0
  },
  "id": 1
}
```

Response:

```
{
  "jsonrpc": "2.0",
  "result": {
    "itemids": [
      "10092"
    ]
  },
  "id": 1
}
```

Update dependent item

Update Dependent item name and Master item ID. Only dependencies on same host are allowed, therefore Master and Dependent item should have same `hostid`.

Request:

```
{
  "jsonrpc": "2.0",
  "method": "item.update",
  "params": {
    "name": "Dependent item updated name",
    "master_itemid": "25562",
    "itemid": "189019"
  },
  "id": 1
}
```

```
  "id": 1
}
```

Response:

```
{
  "jsonrpc": "2.0",
  "result": {
    "itemids": [
      "189019"
    ]
  },
  "id": 1
}
```

Update HTTP agent item

Enable item value trapping.

Request:

```
{
  "jsonrpc": "2.0",
  "method": "item.update",
  "params": {
    "itemid": "23856",
    "allow_traps": 1
  },
  "id": 1
}
```

Response:

```
{
  "jsonrpc": "2.0",
  "result": {
    "itemids": [
      "23856"
    ]
  },
  "id": 1
}
```

Updating an item with preprocessing

Update an item with item preprocessing rule "In range".

Request:

```
{
  "jsonrpc": "2.0",
  "method": "item.update",
  "params": {
    "itemid": "23856",
    "preprocessing": [
      {
        "type": 13,
        "params": "\n100",
        "error_handler": 1,
        "error_handler_params": ""
      }
    ]
  },
  "id": 1
}
```

Response:

```
{
  "jsonrpc": "2.0",
  "result": {
    "itemids": [
      "23856"
    ]
  },
  "id": 1
}
```

Updating a script item

Update a script item with a different script and remove unnecessary parameters that were used by previous script.

Request:

```
{
  "jsonrpc": "2.0",
  "method": "item.update",
  "params": {
    "itemid": "23865",
    "parameters": [],
    "script": "Zabbix.log(3, 'Log test');\nreturn 1;"
  },
  "id": 1
}
```

Response:

```
{
  "jsonrpc": "2.0",
  "result": {
    "itemids": [
      "23865"
    ]
  },
  "id": 1
}
```

Source

`CItem::update()` in `ui/include/classes/api/services/CItem.php`.

Item prototype

This class is designed to work with item prototypes.

Object references:

- [Item prototype](#)
- [Item prototype tag](#)
- [Item prototype preprocessing](#)

Available methods:

- `itemprototype.create` - create new item prototypes
- `itemprototype.delete` - delete item prototypes
- `itemprototype.get` - retrieve item prototypes
- `itemprototype.update` - update item prototypes

Item prototype object

The following objects are directly related to the `itemprototype` API.

Item prototype

The item prototype object has the following properties.

Property	Type	Description
itemid	ID	ID of the item prototype.
delay	string	<p>Property behavior:</p> <ul style="list-style-type: none"> - <i>read-only</i> - <i>required</i> for update operations <p>Update interval of the item prototype.</p> <p>Accepts seconds or time unit with suffix (e.g., 30s, 1m, 2h, 1d) and, optionally, one or more custom intervals, all separated by semicolons. Custom intervals can be a mix of flexible and scheduling intervals.</p> <p>Accepts user macros and LLD macros. If used, the value must be a single macro. Multiple macros or macros mixed with text are not supported. Flexible intervals may be written as two macros separated by a forward slash (e.g., <code>{ \$FLEX_INTERVAL } / { \$FLEX_PERIOD }</code>).</p> <p>Example: <code>1h;wd1-5h9-18;{ \$Macro1 } / 1-7,00:00-24:00;0/6-7,12:00-24:00;{ \$Macro2 }</code></p> <p>Property behavior:</p> <ul style="list-style-type: none"> - <i>required</i> if type is set to "Zabbix agent" (0), "Simple check" (3), "Zabbix internal" (5), "External check" (10), "Database monitor" (11), "IPMI agent" (12), "SSH agent" (13), "TELNET agent" (14), "Calculated" (15), "JMX agent" (16), "HTTP agent" (19), "SNMP agent" (20), "Script" (21), "Browser" (22), or if type is set to "Zabbix agent (active)" (7) and <code>key_</code> does not contain "mqtt.get"
hostid	ID	ID of the host that the item prototype belongs to.
interfaceid	ID	<p>Property behavior:</p> <ul style="list-style-type: none"> - <i>constant</i> - <i>required</i> for create operations <p>ID of the item prototype's host interface.</p> <p>Property behavior:</p> <ul style="list-style-type: none"> - <i>required</i> if item prototype belongs to host and type is set to "Zabbix agent", "IPMI agent", "JMX agent", "SNMP trap", or "SNMP agent" - <i>supported</i> if item prototype belongs to host and type is set to "Simple check", "External check", "SSH agent", "TELNET agent", or "HTTP agent"
key_	string	Item prototype key.
name	string	<p>Property behavior:</p> <ul style="list-style-type: none"> - <i>required</i> for create operations - <i>read-only</i> for inherited objects <p>Name of the item prototype. Supports user macros.</p> <p>Property behavior:</p> <ul style="list-style-type: none"> - <i>required</i> for create operations - <i>read-only</i> for inherited objects

Property	Type	Description
type	integer	<p>Type of the item prototype.</p> <p>Possible values:</p> <ul style="list-style-type: none"> 0 - Zabbix agent; 2 - Zabbix trapper; 3 - Simple check; 5 - Zabbix internal; 7 - Zabbix agent (active); 10 - External check; 11 - Database monitor; 12 - IPMI agent; 13 - SSH agent; 14 - TELNET agent; 15 - Calculated; 16 - JMX agent; 17 - SNMP trap; 18 - Dependent item; 19 - HTTP agent; 20 - SNMP agent; 21 - Script; 22 - Browser. <p>Property behavior:</p> <ul style="list-style-type: none"> - <i>required</i> for create operations - <i>read-only</i> for inherited objects
url	string	<p>URL string.</p> <p>Supports LLD macros, user macros, {HOST.IP}, {HOST.CONN}, {HOST.DNS}, {HOST.HOST}, {HOST.NAME}, {HOST.PORT}, {ITEM.ID}, {ITEM.KEY}.</p> <p>Property behavior:</p> <ul style="list-style-type: none"> - <i>required</i> if type is set to "HTTP agent" - <i>read-only</i> for inherited objects
value_type	integer	<p>Type of information of the item prototype.</p> <p>Possible values:</p> <ul style="list-style-type: none"> 0 - numeric float; 1 - character; 2 - log; 3 - numeric unsigned; 4 - text; 5 - binary. <p>Property behavior:</p> <ul style="list-style-type: none"> - <i>required</i> for create operations - <i>read-only</i> for inherited objects
allow_traps	integer	<p>Allow to populate value similarly to the trapper item.</p> <p>0 - (<i>default</i>) Do not allow to accept incoming data; 1 - Allow to accept incoming data.</p> <p>Property behavior:</p> <ul style="list-style-type: none"> - <i>supported</i> if type is set to "HTTP agent"

Property	Type	Description
authtype	integer	<p>Authentication method.</p> <p>Possible values if type is set to "SSH agent": 0 - (default) password; 1 - public key.</p> <p>Possible values if type is set to "HTTP agent": 0 - (default) none; 1 - basic; 2 - NTLM; 3 - Kerberos.</p> <p>Property behavior: - supported if type is set to "SSH agent" or "HTTP agent" - read-only for inherited objects (if type is set to "HTTP agent")</p>
description	string	Description of the item prototype.
follow_redirects	integer	<p>Follow response redirects while polling data.</p> <p>Possible values: 0 - Do not follow redirects; 1 - (default) Follow redirects.</p> <p>Property behavior: - supported if type is set to "HTTP agent" - read-only for inherited objects</p>
headers	array	<p>Array of headers that will be sent when performing an HTTP request.</p> <p>Property behavior: - supported if type is set to "HTTP agent" - read-only for inherited objects</p>
history	string	<p>A time unit of how long the history data should be stored. Also accepts user macro and LLD macro.</p> <p>Default: 31d.</p>
http_proxy	string	<p>HTTP(S) proxy connection string.</p> <p>Property behavior: - supported if type is set to "HTTP agent" - read-only for inherited objects</p>
ipmi_sensor	string	<p>IPMI sensor.</p> <p>Property behavior: - required if type is set to "IPMI agent" and key_ is not set to "ipmi.get" - supported if type is set to "IPMI agent" - read-only for inherited objects</p>
jmx_endpoint	string	<p>JMX agent custom connection string.</p> <p>Default: service:jmx:rmi:///jndi/rmi://{HOST.CONN}:{HOST.PORT}/jmxrmi</p> <p>Property behavior: - supported if type is set to "JMX agent"</p>
logtimefmt	string	<p>Format of the time in log entries.</p> <p>Property behavior: - supported if value_type is set to "log" - read-only for inherited objects</p>

Property	Type	Description
master_itemid	ID	ID of the master item.
output_format	integer	<p>Property behavior:</p> <ul style="list-style-type: none"> - <i>required</i> if type is set to "Dependent item" - <i>read-only</i> for inherited objects <p>Should the response be converted to JSON.</p> <p>Possible values:</p> <ul style="list-style-type: none"> 0 - (<i>default</i>) Store raw; 1 - Convert to JSON.
params	string	<p>Property behavior:</p> <ul style="list-style-type: none"> - <i>supported</i> if type is set to "HTTP agent" - <i>read-only</i> for inherited objects <p>Additional parameters depending on the type of the item prototype:</p> <ul style="list-style-type: none"> - executed script for SSH agent and TELNET agent item prototypes; - SQL query for database monitor item prototypes; - formula for calculated item prototypes; - the script for script and browser item prototypes.
parameters	object/array	<p>Property behavior:</p> <ul style="list-style-type: none"> - <i>required</i> if type is set to "Database monitor", "SSH agent", "TELNET agent", "Calculated", "Script", or "Browser" - <i>read-only</i> for inherited objects (if type is set to "Script" or "Browser") <p>Additional parameters if type is set to "Script" or "Browser". Array of objects with name and value properties, where name must be unique.</p>
password	string	<p>Property behavior:</p> <ul style="list-style-type: none"> - <i>supported</i> if type is set to "Script" or "Browser" - <i>read-only</i> for inherited objects <p>Password for authentication.</p>
post_type	integer	<p>Property behavior:</p> <ul style="list-style-type: none"> - <i>required</i> if type is set to "JMX agent" and username is set - <i>supported</i> if type is set to "Simple check", "SSH agent", "TELNET agent", "Database monitor", or "HTTP agent" - <i>read-only</i> for inherited objects (if type is set to "HTTP agent") <p>Type of post data body stored in posts property.</p> <p>Possible values:</p> <ul style="list-style-type: none"> 0 - (<i>default</i>) Raw data. 2 - JSON data. 3 - XML data.
posts	string	<p>Property behavior:</p> <ul style="list-style-type: none"> - <i>supported</i> if type is set to "HTTP agent" - <i>read-only</i> for inherited objects <p>HTTP(S) request body data.</p>
privatekey	string	<p>Property behavior:</p> <ul style="list-style-type: none"> - <i>required</i> if type is set to "HTTP agent" and post_type is set to "JSON data" or "XML data" - <i>supported</i> if type is set to "HTTP agent" and post_type is set to "Raw data" - <i>read-only</i> for inherited objects <p>Name of the private key file.</p>
		<p>Property behavior:</p> <ul style="list-style-type: none"> - <i>required</i> if type is set to "SSH agent" and authType is set to "public key"

Property	Type	Description
publickey	string	Name of the public key file. Property behavior: - <i>required</i> if type is set to "SSH agent" and authType is set to "public key"
query_fields	array	Array of query fields that will be sent when performing an HTTP request. Property behavior: - <i>supported</i> if type is set to "HTTP agent" - <i>read-only</i> for inherited objects
request_method	integer	Type of request method. Possible values: 0 - (<i>default</i>) GET; 1 - POST; 2 - PUT; 3 - HEAD. Property behavior: - <i>supported</i> if type is set to "HTTP agent" - <i>read-only</i> for inherited objects
retrieve_mode	integer	What part of response should be stored. Possible values if request_method is set to "GET", "POST", or "PUT": 0 - (<i>default</i>) Body; 1 - Headers; 2 - Both body and headers will be stored. Possible values if request_method is set to "HEAD": 1 - Headers. Property behavior: - <i>supported</i> if type is set to "HTTP agent" - <i>read-only</i> for inherited objects
snmp_oid	string	SNMP OID. Property behavior: - <i>required</i> if type is set to "SNMP agent" - <i>read-only</i> for inherited objects
ssl_cert_file	string	Public SSL Key file path. Property behavior: - <i>supported</i> if type is set to "HTTP agent" - <i>read-only</i> for inherited objects
ssl_key_file	string	Private SSL Key file path. Property behavior: - <i>supported</i> if type is set to "HTTP agent" - <i>read-only</i> for inherited objects
ssl_key_password	string	Password for SSL Key file. Property behavior: - <i>supported</i> if type is set to "HTTP agent" - <i>read-only</i> for inherited objects
status	integer	Status of the item prototype. Possible values: 0 - (<i>default</i>) enabled item prototype; 1 - disabled item prototype; 3 - unsupported item prototype.

Property	Type	Description
status_codes	string	<p>Ranges of required HTTP status codes, separated by commas. Also supports user macros or LLD macros as part of comma separated list.</p> <p>Example: 200,200-{\$M},{M},200-400</p> <p>Property behavior:</p> <ul style="list-style-type: none"> - <i>supported</i> if type is set to "HTTP agent" - <i>read-only</i> for inherited objects
templateid	ID	<p>ID of the parent template item prototype.</p> <p>Property behavior:</p> <ul style="list-style-type: none"> - <i>read-only</i>
timeout	string	<p>Item data polling request timeout. Accepts seconds or time unit with suffix (e.g., 30s, 1m). Also accepts user macros and LLD macros.</p> <p>Possible values range: 1-600s.</p> <p>Default: "" - use proxy/global settings.</p> <p>Property behavior:</p> <ul style="list-style-type: none"> - <i>supported</i> if type is set to "Zabbix agent" (0), "Simple check" (3) and key_ does not start with "vmware." and "icmpping", "Zabbix agent (active)" (7), "External check" (10), "Database monitor" (11), "SSH agent" (13), "TELNET agent" (14), "HTTP agent" (19), "SNMP agent" (20) and snmp_oid starts with "walk[" or "get[" , "Script" (21), "Browser" (22) - <i>read-only</i> for inherited objects
trapper_hosts	string	<p>Allowed hosts.</p> <p>Property behavior:</p> <ul style="list-style-type: none"> - <i>supported</i> if type is set to "Zabbix trapper", or if type is set to "HTTP agent" and allow_traps is set to "Allow to accept incoming data"
trends	string	<p>A time unit of how long the trends data should be stored. Also accepts user macro and LLD macro.</p> <p>Default: 365d.</p> <p>Property behavior:</p> <ul style="list-style-type: none"> - <i>supported</i> if value_type is set to "numeric float" or "numeric unsigned"
units	string	<p>Value units.</p> <p>Property behavior:</p> <ul style="list-style-type: none"> - <i>supported</i> if value_type is set to "numeric float" or "numeric unsigned" - <i>read-only</i> for inherited objects
username	string	<p>Username for authentication.</p> <p>Property behavior:</p> <ul style="list-style-type: none"> - <i>required</i> if type is set to "SSH agent" or "TELNET agent", or if type is set to "JMX agent" and password is set - <i>supported</i> if type is set to "Simple check", "Database monitor", or "HTTP agent" - <i>read-only</i> for inherited objects (if type is set to "HTTP agent")
uuid	string	<p>Universal unique identifier, used for linking imported item prototypes to already existing ones. Auto-generated, if not given.</p> <p>Property behavior:</p> <ul style="list-style-type: none"> - <i>supported</i> if the item prototype belongs to a template

Property	Type	Description
valuemapid	ID	ID of the associated value map.
verify_host	integer	<p>Property behavior:</p> <ul style="list-style-type: none"> - <i>supported</i> if <code>value_type</code> is set to "numeric float", "character", or "numeric unsigned" - <i>read-only</i> for inherited objects <p>Whether to validate that the host name for the connection matches the one in the host's certificate.</p> <p>Possible values:</p> <ul style="list-style-type: none"> 0 - (<i>default</i>) Do not validate; 1 - Validate.
verify_peer	integer	<p>Property behavior:</p> <ul style="list-style-type: none"> - <i>supported</i> if <code>type</code> is set to "HTTP agent" - <i>read-only</i> for inherited objects <p>Whether to validate that the host's certificate is authentic.</p> <p>Possible values:</p> <ul style="list-style-type: none"> 0 - (<i>default</i>) Do not validate; 1 - Validate.
discover	integer	<p>Property behavior:</p> <ul style="list-style-type: none"> - <i>supported</i> if <code>type</code> is set to "HTTP agent" - <i>read-only</i> for inherited objects <p>Item prototype discovery status.</p> <p>Possible values:</p> <ul style="list-style-type: none"> 0 - (<i>default</i>) new items will be discovered; 1 - new items will not be discovered and existing items will be marked as lost.

HTTP header

The header object has the following properties:

Property	Type	Description
name	string	HTTP header name. Property behavior: - <i>required</i>
value	string	Header value. Property behavior: - <i>required</i>

HTTP query field

The query field object defines a name and value that is used to specify a URL parameter. It has the following properties:

Property	Type	Description
name	string	Name of the parameter. Property behavior: - <i>required</i>
value	string	Parameter value. Property behavior: - <i>required</i>

Item prototype tag

The item prototype tag object has the following properties.

Property	Type	Description
tag	string	Item prototype tag name.
value	string	Property behavior: - <i>required</i> Item prototype tag value.

Item prototype preprocessing

The item prototype preprocessing object has the following properties.

Property	Type	Description
type	integer	The preprocessing option type. Possible values: 1 - Custom multiplier; 2 - Right trim; 3 - Left trim; 4 - Trim; 5 - Regular expression; 6 - Boolean to decimal; 7 - Octal to decimal; 8 - Hexadecimal to decimal; 9 - Simple change; 10 - Change per second; 11 - XML XPath; 12 - JSONPath; 13 - In range; 14 - Matches regular expression; 15 - Does not match regular expression; 16 - Check for error in JSON; 17 - Check for error in XML; 18 - Check for error using regular expression; 19 - Discard unchanged; 20 - Discard unchanged with heartbeat; 21 - JavaScript; 22 - Prometheus pattern; 23 - Prometheus to JSON; 24 - CSV to JSON; 25 - Replace; 26 - Check unsupported; 27 - XML to JSON; 28 - SNMP walk value; 29 - SNMP walk to JSON; 30 - SNMP get value. Property behavior: - <i>required</i>

Property	Type	Description
params	string	<p>Additional parameters used by preprocessing option. Multiple parameters are separated by the newline (\n) character.</p> <p>If type is set to "Check unsupported", the parameters follow a <scope>[\n<pattern>] syntax, where <i>pattern</i> is a regular expression, and <i>scope</i> is one of:</p> <ul style="list-style-type: none"> -1 - match any error; 0 - check if error message matches <i>pattern</i>; 1 - check if error message does not match <i>pattern</i>. <p>Property behavior:</p> <ul style="list-style-type: none"> - <i>required</i> if type is set to "Custom multiplier" (1), "Right trim" (2), "Left trim" (3), "Trim" (4), "Regular expression" (5), "XML XPath" (11), "JSONPath" (12), "In range" (13), "Matches regular expression" (14), "Does not match regular expression" (15), "Check for error in JSON" (16), "Check for error in XML" (17), "Check for error using regular expression" (18), "Discard unchanged with heartbeat" (20), "JavaScript" (21), "Prometheus pattern" (22), "Prometheus to JSON" (23), "CSV to JSON" (24), "Replace" (25), "Check unsupported" (26), "SNMP walk value" (28), "SNMP walk to JSON" (29), or "SNMP get value" (30)
error_handler	integer	<p>Action type used in case of preprocessing step failure.</p> <p>Possible values:</p> <ul style="list-style-type: none"> 0 - Error message is set by Zabbix server; 1 - Discard value; 2 - Set custom value; 3 - Set custom error message. <p>Possible values if type is set to "Check unsupported":</p> <ul style="list-style-type: none"> 1 - Discard value; 2 - Set custom value; 3 - Set custom error message. <p>Property behavior:</p> <ul style="list-style-type: none"> - <i>required</i> if type is set to "Custom multiplier" (1), "Regular expression" (5), "Boolean to decimal" (6), "Octal to decimal" (7), "Hexadecimal to decimal" (8), "Simple change" (9), "Change per second" (10), "XML XPath" (11), "JSONPath" (12), "In range" (13), "Matches regular expression" (14), "Does not match regular expression" (15), "Check for error in JSON" (16), "Check for error in XML" (17), "Check for error using regular expression" (18), "Prometheus pattern" (22), "Prometheus to JSON" (23), "CSV to JSON" (24), "Check unsupported" (26), "XML to JSON" (27), "SNMP walk value" (28), "SNMP walk to JSON" (29), or "SNMP get value" (30)
error_handler_params	string	<p>Error handler parameters.</p> <p>Property behavior:</p> <ul style="list-style-type: none"> - <i>required</i> if <code>error_handler</code> is set to "Set custom value" or "Set custom error message"

The following parameters and error handlers are supported for each preprocessing type.

Preprocessing type	Name	Parameter 1	Parameter 2	Parameter 3	Supported error handlers
1	Custom multiplier	number ^{1, 6}			0, 1, 2, 3
2	Right trim	list of characters ²			

Preprocessing type	Name	Parameter 1	Parameter 2	Parameter 3	Supported error handlers
3	Left trim	list of characters ²			
4	Trim	list of characters ²			
5	Regular expression	pattern ³	output ²		0, 1, 2, 3
6	Boolean to decimal				0, 1, 2, 3
7	Octal to decimal				0, 1, 2, 3
8	Hexadecimal to decimal				0, 1, 2, 3
9	Simple change				0, 1, 2, 3
10	Change per second				0, 1, 2, 3
11	XML XPath	path ⁴			0, 1, 2, 3
12	JSONPath	path ⁴			0, 1, 2, 3
13	In range	min ^{1,6}	max ^{1,6}		0, 1, 2, 3
14	Matches regular expression	pattern ³			0, 1, 2, 3
15	Does not match regular expression	pattern ³			0, 1, 2, 3
16	Check for error in JSON	path ⁴			0, 1, 2, 3
17	Check for error in XML	path ⁴			0, 1, 2, 3

Preprocessing type	Name	Parameter 1	Parameter 2	Parameter 3	Supported error handlers
18	Check for error using regular expression	pattern ³	output ²		0, 1, 2, 3
19	Discard unchanged				
20	Discard seconds unchanged with heartbeat	seconds ^{5, 6}			
21	JavaScript	pattern ²			
22	Prometheus pattern	pattern ^{6, 7}	value, label, function	output ^{8, 9}	0, 1, 2, 3
23	Prometheus to JSON	pattern ^{6, 7}			0, 1, 2, 3
24	CSV to JSON	character ²	character ²	0,1	0, 1, 2, 3
25	Replace search string	scope ¹	replacement ²		
26	Check unsupported XML	scope ¹	pattern ^{3, 6}		1, 2, 3
27	XML to JSON				0, 1, 2, 3
28	SNMP walk value	OID ²	Format: 0 - Unchanged 1 - UTF-8 from Hex-STRING 2 - MAC from Hex-STRING 3 - Integer from BITS		0, 1, 2, 3
29	SNMP walk to JSON ¹⁰	Field name ²	OID prefix ²	Format: 0 - Unchanged 1 - UTF-8 from Hex-STRING 2 - MAC from Hex-STRING 3 - Integer from BITS	0, 1, 2, 3
30	SNMP get value	Format: 1 - UTF-8 from Hex-STRING 2 - MAC from Hex-STRING 3 - Integer from BITS			0, 1, 2, 3

¹ integer or floating-point number

² string

³ regular expression

⁴ JSONPath or XML XPath

⁵ positive integer (with support of time suffixes, e.g. 30s, 1m, 2h, 1d)

⁶ user macro, LLD macro

⁷ Prometheus pattern following the syntax: `<metric name>{<label name>=<label value>, ...} == <value>`. Each Prometheus pattern component (metric, label name, label value and metric value) can be user macro or LLD macro.

⁸ Prometheus output following the syntax: `<label name>` (can be a user macro or an LLD macro) if label is selected as the second parameter.

⁹ One of the aggregation functions: `sum`, `min`, `max`, `avg`, `count` if function is selected as the second parameter.

¹⁰ Supports multiple "Field name,OID prefix,Format records" records delimited by a new line character.

itemprototype.create

Description

object `itemprototype.create(object/array itemPrototypes)`

This method allows to create new item prototypes.

Note:

This method is only available to *Admin* and *Super admin* user types. Permissions to call the method can be revoked in user role settings. See [User roles](#) for more information.

Parameters

(object/array) Item prototype to create.

Additionally to the [standard item prototype properties](#), the method accepts the following parameters.

Parameter	Type	Description
ruleid	ID	ID of the LLD rule that the item belongs to. Parameter behavior: - <i>required</i>
preprocessing	array	Item prototype preprocessing options.
tags	array	Item prototype tags .

Return values

(object) Returns an object containing the IDs of the created item prototypes under the `itemids` property. The order of the returned IDs matches the order of the passed item prototypes.

Examples

Creating an item prototype

Create an item prototype to monitor free disk space on a discovered file system. Discovered items should be numeric Zabbix agent items updated every 30 seconds.

Request:

```
{
  "jsonrpc": "2.0",
  "method": "itemprototype.create",
  "params": {
    "name": "Free disk space on {#FSNAME}",
    "key_": "vfs.fs.size[{#FSNAME},free]",
    "hostid": "10197",
    "ruleid": "27665",
    "type": 0,
    "value_type": 3,
    "interfaceid": "112",
    "delay": "30s"
  },
}
```

```
"id": 1
}
```

Response:

```
{
  "jsonrpc": "2.0",
  "result": {
    "itemids": [
      "27666"
    ]
  },
  "id": 1
}
```

Creating an item prototype with preprocessing

Create an item using change per second and a custom multiplier as a second step.

Request:

```
{
  "jsonrpc": "2.0",
  "method": "itemprototype.create",
  "params": {
    "name": "Incoming network traffic on {#IFNAME}",
    "key_": "net.if.in[{#IFNAME}]",
    "hostid": "10001",
    "ruleid": "27665",
    "type": 0,
    "value_type": 3,
    "delay": "60s",
    "units": "bps",
    "interfaceid": "1155",
    "preprocessing": [
      {
        "type": 10,
        "params": "",
        "error_handler": 0,
        "error_handler_params": ""
      },
      {
        "type": 1,
        "params": "8",
        "error_handler": 2,
        "error_handler_params": "10"
      }
    ]
  },
  "id": 1
}
```

Response:

```
{
  "jsonrpc": "2.0",
  "result": {
    "itemids": [
      "44211"
    ]
  },
  "id": 1
}
```

Creating dependent item prototype

Create Dependent item prototype for Master item prototype with ID 44211. Only dependencies on same host (template/discovery

rule) are allowed, therefore Master and Dependent item should have same hostid and ruleid.

Request:

```
{
  "jsonrpc": "2.0",
  "method": "itemprototype.create",
  "params": {
    "hostid": "10001",
    "ruleid": "27665",
    "name": "Dependent test item prototype",
    "key_": "dependent.prototype",
    "type": 18,
    "master_itemid": "44211",
    "value_type": 3
  },
  "id": 1
}
```

Response:

```
{
  "jsonrpc": "2.0",
  "result": {
    "itemids": [
      "44212"
    ]
  },
  "id": 1
}
```

Create HTTP agent item prototype

Create item prototype with URL using user macro, query fields and custom headers.

Request:

```
{
  "jsonrpc": "2.0",
  "method": "itemprototype.create",
  "params": {
    "type": "19",
    "hostid": "10254",
    "ruleid": "28256",
    "interfaceid": "2",
    "name": "api item prototype example",
    "key_": "api_http_item",
    "value_type": 3,
    "url": "${URL_PROTOTYPE}",
    "query_fields": [
      {
        "name": "min",
        "value": "10"
      },
      {
        "name": "max",
        "value": "100"
      }
    ],
    "headers": [
      {
        "name": "X-Source",
        "value": "api"
      }
    ],
    "delay": "35"
  },
  "id": 1
}
```

```
    "id": 1
  }
}
```

Response:

```
{
  "jsonrpc": "2.0",
  "result": {
    "itemids": [
      "28305"
    ]
  },
  "id": 1
}
```

Create script item prototype

Create a simple data collection using a script item prototype.

Request:

```
{
  "jsonrpc": "2.0",
  "method": "itemprototype.create",
  "params": {
    "name": "Script example",
    "key_": "custom.script.itemprototype",
    "hostid": "12345",
    "type": 21,
    "value_type": 4,
    "params": "var request = new HttpRequest();\nreturn request.post(\"https://postman-echo.com/post\")",
    "parameters": [
      {
        "name": "host",
        "value": "{HOST.CONN}"
      }
    ]
  },
  "timeout": "6s",
  "delay": "30s"
},
"id": 1
}
```

Response:

```
{
  "jsonrpc": "2.0",
  "result": {
    "itemids": [
      "23865"
    ]
  },
  "id": 1
}
```

Source

`CItemPrototype::create()` in `ui/include/classes/api/services/CItemPrototype.php`.

itemprototype.delete

Description

object `itemprototype.delete(array itemPrototypeIds)`

This method allows to delete item prototypes.

Note:

This method is only available to *Admin* and *Super admin* user types. Permissions to call the method can be revoked in user role settings. See [User roles](#) for more information.

Parameters

(array) IDs of the item prototypes to delete.

Return values

(object) Returns an object containing the IDs of the deleted item prototypes under the `prototypeids` property.

Examples**Deleting multiple item prototypes**

Delete two item prototypes.

Dependent item prototypes are removed automatically if master item or item prototype is deleted.

Request:

```
{
  "jsonrpc": "2.0",
  "method": "itemprototype.delete",
  "params": [
    "27352",
    "27356"
  ],
  "id": 1
}
```

Response:

```
{
  "jsonrpc": "2.0",
  "result": {
    "prototypeids": [
      "27352",
      "27356"
    ]
  },
  "id": 1
}
```

Source

`CItemPrototype::delete()` in `ui/include/classes/api/services/CItemPrototype.php`.

itemprototype.get**Description**

integer/array `itemprototype.get(object parameters)`

The method allows to retrieve item prototypes according to the given parameters.

Note:

This method is available to users of any type. Permissions to call the method can be revoked in user role settings. See [User roles](#) for more information.

Parameters

(object) Parameters defining the desired output.

The method supports the following parameters.

Parameter	Type	Description
discoveryids	ID/array	Return only item prototypes that belong to the given LLD rules.

Parameter	Type	Description
graphids	ID/array	Return only item prototypes that are used in the given graph prototypes.
hostids	ID/array	Return only item prototypes that belong to the given hosts.
inherited	boolean	If set to true return only item prototypes inherited from a template.
itemids	ID/array	Return only item prototypes with the given IDs.
monitored	boolean	If set to true return only enabled item prototypes that belong to monitored hosts.
templated	boolean	If set to true return only item prototypes that belong to templates.
templateids	ID/array	Return only item prototypes that belong to the given templates.
triggerids	ID/array	Return only item prototypes that are used in the given trigger prototypes.
selectDiscoveryRule	query	Return a discoveryRule property with the low-level discovery rule that the item prototype belongs to.
selectGraphs	query	Return a graphs property with graph prototypes that the item prototype is used in.
selectHosts	query	Supports count. Return a hosts property with an array of hosts that the item prototype belongs to.
selectTags	query	Return the item prototype tags in tags property.
selectTriggers	query	Return a triggers property with trigger prototypes that the item prototype is used in.
selectPreprocessing	query	Supports count. Return a preprocessing property with item prototype preprocessing options.
selectValueMap filter	query object	Return a valuemap property with item prototype value map. Return only those results that exactly match the given filter.
		Accepts an object, where the keys are property names, and the values are either a single value or an array of values to match against.
		Does not support properties of text data type .
		Supports additional properties: host - technical name of the host that the item prototype belongs to.
limitSelects	integer	Limits the number of records returned by subselects.
		Applies to the following subselects: selectGraphs - results will be sorted by name; selectTriggers - results will be sorted by description.
sortfield	string/array	Sort the result by the given properties.
		Possible values: itemid, name, key_, delay, type, status .
countOutput	boolean	These parameters being common for all get methods are described in detail in the reference commentary .
editable	boolean	
excludeSearch	boolean	
limit	integer	
output	query	
preservekeys	boolean	
search	object	
searchByAny	boolean	
searchWildcardsEnabled	boolean	
sortorder	string/array	
startSearch	boolean	

Return values

(integer/array) Returns either:

- an array of objects;

- the count of retrieved objects, if the countOutput parameter has been used.

Examples

Retrieving item prototypes from an LLD rule

Retrieve all item prototypes for specific LLD rule ID.

Request:

```
{
  "jsonrpc": "2.0",
  "method": "itemprototype.get",
  "params": {
    "output": "extend",
    "discoveryids": "27426"
  },
  "id": 1
}
```

Response:

```
{
  "jsonrpc": "2.0",
  "result": [
    {
      "itemid": "23077",
      "type": "0",
      "snmp_oid": "",
      "hostid": "10079",
      "name": "Incoming network traffic on en0",
      "key_": "net.if.in[en0]",
      "delay": "1m",
      "history": "1w",
      "trends": "365d",
      "status": "0",
      "value_type": "3",
      "trapper_hosts": "",
      "units": "bps",
      "logtimefmt": "",
      "templateid": "0",
      "valuemapid": "0",
      "params": "",
      "ipmi_sensor": "",
      "authtype": "0",
      "username": "",
      "password": "",
      "publickey": "",
      "privatekey": "",
      "interfaceid": "0",
      "description": "",
      "evaltype": "0",
      "jmx_endpoint": "",
      "master_itemid": "0",
      "timeout": "",
      "url": "",
      "query_fields": [],
      "posts": "",
      "status_codes": "200",
      "follow_redirects": "1",
      "post_type": "0",
      "http_proxy": "",
      "headers": [],
      "retrieve_mode": "0",
      "request_method": "0",
      "output_format": "0",
    }
  ]
}
```

```

    "ssl_cert_file": "",
    "ssl_key_file": "",
    "ssl_key_password": "",
    "verify_peer": "0",
    "verify_host": "0",
    "allow_traps": "0",
    "discover": "0",
    "uuid": "",
    "parameters": []
  },
  {
    "itemid": "10010",
    "type": "0",
    "snmp_oid": "",
    "hostid": "10001",
    "name": "Processor load (1 min average per core)",
    "key_": "system.cpu.load[percpu,avg1]",
    "delay": "1m",
    "history": "1w",
    "trends": "365d",
    "status": "0",
    "value_type": "0",
    "trapper_hosts": "",
    "units": "",
    "logtimefmt": "",
    "templateid": "0",
    "valuemapid": "0",
    "params": "",
    "ipmi_sensor": "",
    "authtype": "0",
    "username": "",
    "password": "",
    "publickey": "",
    "privatekey": "",
    "interfaceid": "0",
    "description": "The processor load is calculated as system CPU load divided by number of CPU c",
    "evaltype": "0",
    "jmx_endpoint": "",
    "master_itemid": "0",
    "timeout": "",
    "url": "",
    "query_fields": [],
    "posts": "",
    "status_codes": "200",
    "follow_redirects": "1",
    "post_type": "0",
    "http_proxy": "",
    "headers": [],
    "retrieve_mode": "0",
    "request_method": "0",
    "output_format": "0",
    "ssl_cert_file": "",
    "ssl_key_file": "",
    "ssl_key_password": "",
    "verify_peer": "0",
    "verify_host": "0",
    "allow_traps": "0",
    "discover": "0",
    "uuid": "",
    "parameters": []
  }
],

```

```
"id": 1
}
```

Finding dependent item

Find one Dependent item for specific item ID.

Request:

```
{
  "jsonrpc": "2.0",
  "method": "item.get",
  "params": {
    "output": "extend",
    "filter": {
      "type": 18,
      "master_itemid": "25545"
    },
    "limit": "1"
  },
  "id": 1
}
```

Response:

```
{
  "jsonrpc": "2.0",
  "result": [
    {
      "itemid": "25547",
      "type": "18",
      "snmp_oid": "",
      "hostid": "10116",
      "name": "Seconds",
      "key_": "apache.status.uptime.seconds",
      "delay": "0",
      "history": "90d",
      "trends": "365d",
      "status": "0",
      "value_type": "3",
      "trapper_hosts": "",
      "units": "",
      "logtimefmt": "",
      "templateid": "0",
      "valuemapid": "0",
      "params": "",
      "ipmi_sensor": "",
      "authtype": "0",
      "username": "",
      "password": "",
      "publickey": "",
      "privatekey": "",
      "interfaceid": "0",
      "description": "",
      "evaltype": "0",
      "master_itemid": "25545",
      "jmx_endpoint": "",
      "timeout": "",
      "url": "",
      "query_fields": [],
      "posts": "",
      "status_codes": "200",
      "follow_redirects": "1",
      "post_type": "0",
      "http_proxy": "",

```

```

        "headers": [],
        "retrieve_mode": "0",
        "request_method": "0",
        "output_format": "0",
        "ssl_cert_file": "",
        "ssl_key_file": "",
        "ssl_key_password": "",
        "verify_peer": "0",
        "verify_host": "0",
        "allow_traps": "0",
        "discover": "0",
        "uuid": "",
        "parameters": []
    }
],
    "id": 1
}

```

Find HTTP agent item prototype

Find HTTP agent item prototype with request method HEAD for specific host ID.

Request:

```

{
    "jsonrpc": "2.0",
    "method": "itemprototype.get",
    "params": {
        "hostids": "10254",
        "filter": {
            "type": 19,
            "request_method": 3
        }
    }
},
    "id": 1
}

```

Response:

```

{
    "jsonrpc": "2.0",
    "result": [
        {
            "itemid": "28257",
            "type": "19",
            "snmp_oid": "",
            "hostid": "10254",
            "name": "discovered",
            "key_": "item[{-#INAME}]",
            "delay": "{-#IUPDATE}",
            "history": "90d",
            "trends": "30d",
            "status": "0",
            "value_type": "3",
            "trapper_hosts": "",
            "units": "",
            "logtimefmt": "",
            "templateid": "28255",
            "valuemapid": "0",
            "params": "",
            "ipmi_sensor": "",
            "authtype": "0",
            "username": "",
            "password": "",
            "publickey": ""
        }
    ]
}

```

```

        "privatekey": "",
        "flags": "2",
        "interfaceid": "2",
        "description": "",
        "evaltype": "0",
        "jmx_endpoint": "",
        "master_itemid": "0",
        "timeout": "",
        "url": "{#IURL}",
        "query_fields": [],
        "posts": "",
        "status_codes": "",
        "follow_redirects": "0",
        "post_type": "0",
        "http_proxy": "",
        "headers": [],
        "retrieve_mode": "0",
        "request_method": "3",
        "output_format": "0",
        "ssl_cert_file": "",
        "ssl_key_file": "",
        "ssl_key_password": "",
        "verify_peer": "0",
        "verify_host": "0",
        "allow_traps": "0",
        "discover": "0",
        "uuid": "",
        "parameters": []
    }
],
    "id": 1
}

```

See also

- [Host](#)
- [Graph prototype](#)
- [Trigger prototype](#)

Source

`CItemPrototype::get()` in `ui/include/classes/api/services/CItemPrototype.php`.

itemprototype.update

Description

`object itemprototype.update(object/array itemPrototypes)`

This method allows to update existing item prototypes.

Note:

This method is only available to *Admin* and *Super admin* user types. Permissions to call the method can be revoked in user role settings. See [User roles](#) for more information.

Parameters

(object/array) Item prototype properties to be updated.

The `itemid` property must be defined for each item prototype, all other properties are optional. Only the passed properties will be updated, all others will remain unchanged.

Additionally to the [standard item prototype properties](#), the method accepts the following parameters.

Parameter	Type	Description
preprocessing	array	Item prototype preprocessing options to replace the current preprocessing options.
tags	array	Parameter behavior: - <i>read-only</i> for inherited objects Item prototype tags.

Return values

(object) Returns an object containing the IDs of the updated item prototypes under the `itemids` property.

Examples

Changing the interface of an item prototype

Change the host interface that will be used by discovered items.

Request:

```
{
  "jsonrpc": "2.0",
  "method": "itemprototype.update",
  "params": {
    "itemid": "27428",
    "interfaceid": "132"
  },
  "id": 1
}
```

Response:

```
{
  "jsonrpc": "2.0",
  "result": {
    "itemids": [
      "27428"
    ]
  },
  "id": 1
}
```

Update dependent item prototype

Update Dependent item prototype with new Master item prototype ID. Only dependencies on same host (template/discovery rule) are allowed, therefore Master and Dependent item should have same `hostid` and `ruleid`.

Request:

```
{
  "jsonrpc": "2.0",
  "method": "itemprototype.update",
  "params": {
    "master_itemid": "25570",
    "itemid": "189030"
  },
  "id": 1
}
```

Response:

```
{
  "jsonrpc": "2.0",
  "result": {
    "itemids": [
      "189030"
    ]
  },
  "id": 1
}
```

```
  "id": 1
}
```

Update HTTP agent item prototype

Change query fields and remove all custom headers.

Request:

```
{
  "jsonrpc": "2.0",
  "method": "itemprototype.update",
  "params": {
    "itemid": "28305",
    "query_fields": [
      {
        "name": "random",
        "value": "qwertyuiopasdfghjklzxcvbnm"
      }
    ],
    "headers": []
  }
  "id": 1
}
```

Response:

```
{
  "jsonrpc": "2.0",
  "result": {
    "itemids": [
      "28305"
    ]
  },
  "id": 1
}
```

Updating item preprocessing options

Update an item prototype with item preprocessing rule "Custom multiplier".

Request:

```
{
  "jsonrpc": "2.0",
  "method": "itemprototype.update",
  "params": {
    "itemid": "44211",
    "preprocessing": [
      {
        "type": 1,
        "params": "4",
        "error_handler": 2,
        "error_handler_params": "5"
      }
    ]
  },
  "id": 1
}
```

Response:

```
{
  "jsonrpc": "2.0",
  "result": {
    "itemids": [
      "44211"
    ]
  }
}
```



```
},
  "id": 1
}
```

Updating a script item prototype

Update a script item prototype with a different script and remove unnecessary parameters that were used by previous script.

Request:

```
{
  "jsonrpc": "2.0",
  "method": "itemprototype.update",
  "params": {
    "itemid": "23865",
    "parameters": [],
    "script": "Zabbix.log(3, 'Log test');\nreturn 1;"
  },
  "id": 1
}
```

Response:

```
{
  "jsonrpc": "2.0",
  "result": {
    "itemids": [
      "23865"
    ]
  },
  "id": 1
}
```

Source

`CItemPrototype::update()` in `ui/include/classes/api/services/CItemPrototype.php`.

LLD rule

This class is designed to work with low-level discovery rules.

Object references:

- [LLD rule](#)
- [LLD rule filter](#)
- [LLD rule filter condition](#)
- [LLD macro path](#)
- [LLD rule preprocessing](#)
- [LLD rule overrides](#)
- [LLD rule override filter](#)
- [LLD rule override filter condition](#)
- [LLD rule override operation](#)
- [LLD rule override operation status](#)
- [LLD rule override operation discover](#)
- [LLD rule override operation period](#)
- [LLD rule override operation history](#)
- [LLD rule override operation trends](#)
- [LLD rule override operation severity](#)
- [LLD rule override operation tag](#)
- [LLD rule override operation template](#)
- [LLD rule override operation inventory](#)

Available methods:

- [discoveryrule.create](#) - create new LLD rules
- [discoveryrule.delete](#) - delete LLD rules
- [discoveryrule.get](#) - retrieve LLD rules

- `discoveryrule.update` - update LLD rules

LLD rule object

The following objects are directly related to the `discoveryrule` API.

LLD rule

The low-level discovery rule object has the following properties.

Property	Type	Description
<code>itemid</code>	ID	ID of the LLD rule. Property behavior: - <i>read-only</i>
<code>delay</code>	string	- <i>required</i> for update operations Update interval of the LLD rule. Accepts seconds or time unit with suffix (e.g., 30s, 1m, 2h, 1d) and, optionally, one or more custom intervals , all separated by semicolons. Custom intervals can be a mix of flexible and scheduling intervals. Accepts user macros. If used, the value must be a single macro. Multiple macros or macros mixed with text are not supported. Flexible intervals may be written as two macros separated by a forward slash (e.g., <code>{FLEX_INTERVAL}/{FLEX_PERIOD}</code>). Example: <code>1h;wd1-5h9-18;{\$Macro1}/1-7,00:00-24:00;0/6-7,12:00-24:00;{\$Macro2}</code> Property behavior: - <i>required</i> if <code>type</code> is set to "Zabbix agent" (0), "Simple check" (3), "Zabbix internal" (5), "External check" (10), "Database monitor" (11), "IPMI agent" (12), "SSH agent" (13), "TELNET agent" (14), "JMX agent" (16), "HTTP agent" (19), "SNMP agent" (20), "Script" (21), "Browser" (22), or if <code>type</code> is set to "Zabbix agent (active)" (7) and <code>key_</code> does not contain "mqtt.get"
<code>hostid</code>	ID	ID of the host that the LLD rule belongs to. Property behavior: - <i>constant</i>
<code>interfaceid</code>	ID	- <i>required</i> for create operations ID of the LLD rule's host interface. Property behavior: - <i>required</i> if LLD rule belongs to host and <code>type</code> is set to "Zabbix agent", "IPMI agent", "JMX agent", or "SNMP agent" - <i>supported</i> if LLD rule belongs to host and <code>type</code> is set to "Simple check", "External check", "SSH agent", "TELNET agent", or "HTTP agent"
<code>key_</code>	string	LLD rule key. Property behavior: - <i>required</i> for create operations - <i>read-only</i> for inherited objects
<code>name</code>	string	Name of the LLD rule. Property behavior: - <i>required</i> for create operations - <i>read-only</i> for inherited objects

Property	Type	Description
type	integer	Type of the LLD rule. Possible values: 0 - Zabbix agent; 2 - Zabbix trapper; 3 - Simple check; 5 - Zabbix internal; 7 - Zabbix agent (active); 10 - External check; 11 - Database monitor; 12 - IPMI agent; 13 - SSH agent; 14 - TELNET agent; 16 - JMX agent; 18 - Dependent item; 19 - HTTP agent; 20 - SNMP agent; 21 - Script; 22 - Browser. Property behavior: - <i>required</i> for create operations - <i>read-only</i> for inherited objects
url	string	URL string. Supports user macros, {HOST.IP}, {HOST.CONN}, {HOST.DNS}, {HOST.HOST}, {HOST.NAME}, {HOST.PORT}, {ITEM.ID}, {ITEM.KEY}. Property behavior: - <i>required</i> if type is set to "HTTP agent" - <i>read-only</i> for inherited objects
allow_traps	integer	Allow to populate value similarly to the trapper item. Possible values: 0 - (<i>default</i>) Do not allow to accept incoming data; 1 - Allow to accept incoming data. Property behavior: - <i>supported</i> if type is set to "HTTP agent"
authtype	integer	Authentication method. Possible values if type is set to "SSH agent": 0 - (<i>default</i>) password; 1 - public key. Possible values if type is set to "HTTP agent": 0 - (<i>default</i>) none; 1 - basic; 2 - NTLM. Property behavior: - <i>supported</i> if type is set to "SSH agent" or "HTTP agent" - <i>read-only</i> for inherited objects (if type is set to "HTTP agent")
description	string	Description of the LLD rule.
error	string	Error text if there are problems updating the LLD rule value. Property behavior: - <i>read-only</i>

Property	Type	Description
follow_redirects	integer	Follow response redirects while polling data. Possible values: 0 - Do not follow redirects; 1 - <i>(default)</i> Follow redirects. Property behavior: - <i>supported</i> if <code>type</code> is set to "HTTP agent" - <i>read-only</i> for inherited objects
headers	array	Array of <code>headers</code> that will be sent when performing an HTTP request. Property behavior: - <i>supported</i> if <code>type</code> is set to "HTTP agent" - <i>read-only</i> for inherited objects
http_proxy	string	HTTP(S) proxy connection string. Property behavior: - <i>supported</i> if <code>type</code> is set to "HTTP agent" - <i>read-only</i> for inherited objects
ipmi_sensor	string	IPMI sensor. Property behavior: - <i>required</i> if <code>type</code> is set to "IPMI agent" and <code>key_</code> is not set to "ipmi.get" - <i>supported</i> if <code>type</code> is set to "IPMI agent" - <i>read-only</i> for inherited objects
jmx_endpoint	string	JMX agent custom connection string. Default: service:jmx:rmi:///jndi/rmi://{HOST.CONN}:{HOST.PORT}/jmxrmi Property behavior: - <i>supported</i> if <code>type</code> is set to "JMX agent" - <i>read-only</i> for inherited objects
lifetime	string	Time period after which items that are no longer discovered will be deleted. Accepts seconds, time unit with suffix, or a user macro. Default: 7d.
lifetime_type	integer	Scenario to delete lost LLD resources. Possible values: 0 - <i>(default)</i> Delete after lifetime threshold is reached; 1 - Do not delete; 2 - Delete immediately.
enabled_lifetime	string	Time period after which items that are no longer discovered will be disabled. Accepts seconds, time unit with suffix, or a user macro. Default: 0.
enabled_lifetime_type	integer	Scenario to disable lost LLD resources. Possible values: 0 - Disable after lifetime threshold is reached; 1 - Do not disable; 2 - <i>(default)</i> Disable immediately.
master_itemid	ID	ID of the master item. Discovery rule cannot be master item for another discovery rule. Property behavior: - <i>required</i> if <code>type</code> is set to "Dependent item" - <i>read-only</i> for inherited objects

Property	Type	Description
output_format	integer	Should the response be converted to JSON. Possible values: 0 - (default) Store raw; 1 - Convert to JSON.
params	string	Property behavior: - supported if type is set to "HTTP agent" - read-only for inherited objects Additional parameters depending on the type of the LLD rule: - executed script for SSH and Telnet LLD rules; - SQL query for database monitor LLD rules; - formula for calculated LLD rules; - the script for script and browser LLD rules.
parameters	object/array	Property behavior: - required if type is set to "Database monitor", "SSH agent", "TELNET agent", "Script" or "Browser" - read-only for inherited objects (if type is set to "Script" or "Browser") Additional parameters if type is set to "Script" or "Browser". Array of objects with name and value properties, where name must be unique.
password	string	Property behavior: - supported if type is set to "Script" or "Browser" - read-only for inherited objects Password for authentication.
post_type	integer	Property behavior: - required if type is set to "JMX agent" and username is set - supported if type is set to "Simple check", "Database monitor", "SSH agent", "TELNET agent", or "HTTP agent" - read-only for inherited objects (if type is set to "HTTP agent") Type of post data body stored in posts property. Possible values: 0 - (default) Raw data; 2 - JSON data; 3 - XML data.
posts	string	Property behavior: - supported if type is set to "HTTP agent" - read-only for inherited objects HTTP(S) request body data.
privatekey	string	Property behavior: - required if type is set to "HTTP agent" and post_type is set to "JSON data" or "XML data" - supported if type is set to "HTTP agent" and post_type is set to "Raw data" - read-only for inherited objects Name of the private key file.
publickey	string	Property behavior: - required if type is set to "SSH agent" and authtype is set to "public key" Name of the public key file.
		Property behavior: - required if type is set to "SSH agent" and authtype is set to "public key"

Property	Type	Description
query_fields	array	Array of query fields that will be sent when performing an HTTP request.
request_method	integer	<p>Property behavior:</p> <ul style="list-style-type: none"> - <i>supported</i> if <code>type</code> is set to "HTTP agent" - <i>read-only</i> for inherited objects <p>Type of request method.</p> <p>Possible values:</p> <ul style="list-style-type: none"> 0 - (<i>default</i>) GET; 1 - POST; 2 - PUT; 3 - HEAD. <p>Property behavior:</p> <ul style="list-style-type: none"> - <i>supported</i> if <code>type</code> is set to "HTTP agent" - <i>read-only</i> for inherited objects
retrieve_mode	integer	<p>What part of response should be stored.</p> <p>Possible values if <code>request_method</code> is set to "GET", "POST", or "PUT":</p> <ul style="list-style-type: none"> 0 - (<i>default</i>) Body; 1 - Headers; 2 - Both body and headers will be stored. <p>Possible values if <code>request_method</code> is set to "HEAD":</p> <ul style="list-style-type: none"> 1 - Headers. <p>Property behavior:</p> <ul style="list-style-type: none"> - <i>supported</i> if <code>type</code> is set to "HTTP agent" - <i>read-only</i> for inherited objects
snmp_oid	string	<p>SNMP OID.</p> <p>Property behavior:</p> <ul style="list-style-type: none"> - <i>required</i> if <code>type</code> is set to "SNMP agent" - <i>read-only</i> for inherited objects
ssl_cert_file	string	<p>Public SSL Key file path.</p> <p>Property behavior:</p> <ul style="list-style-type: none"> - <i>supported</i> if <code>type</code> is set to "HTTP agent" - <i>read-only</i> for inherited objects
ssl_key_file	string	<p>Private SSL Key file path.</p> <p>Property behavior:</p> <ul style="list-style-type: none"> - <i>supported</i> if <code>type</code> is set to "HTTP agent" - <i>read-only</i> for inherited objects
ssl_key_password	string	<p>Password for SSL Key file.</p> <p>Property behavior:</p> <ul style="list-style-type: none"> - <i>supported</i> if <code>type</code> is set to "HTTP agent" - <i>read-only</i> for inherited objects
state	integer	<p>State of the LLD rule.</p> <p>Possible values:</p> <ul style="list-style-type: none"> 0 - (<i>default</i>) normal; 1 - not supported. <p>Property behavior:</p> <ul style="list-style-type: none"> - <i>read-only</i>

Property	Type	Description
status	integer	Status of the LLD rule. Possible values: 0 - (default) enabled LLD rule; 1 - disabled LLD rule.
status_codes	string	Ranges of required HTTP status codes, separated by commas. Also supports user macros as part of comma separated list. Example: 200,200-{\$M},{M},200-400 Property behavior: - supported if type is set to "HTTP agent" - read-only for inherited objects
templateid	ID	ID of the parent template LLD rule. Property behavior: - read-only
timeout	string	Item data polling request timeout. Accepts seconds or time unit with suffix (e.g., 30s, 1m). Also accepts user macros. Possible values range: 1-600s. Default: "" - use proxy/global settings. Property behavior: - supported if type is set to "Zabbix agent" (0), "Simple check" (3) and key_ does not start with "vmware." and "icmpping", "Zabbix agent (active)" (7), "External check" (10), "Database monitor" (11), "SSH agent" (13), "TELNET agent" (14), "HTTP agent" (19), "SNMP agent" (20) and snmp_oid starts with "walk[" or "get[" , "Script" (21), "Browser" (22) - read-only for inherited objects
trapper_hosts	string	Allowed hosts. Property behavior: - supported if type is set to "Zabbix trapper", or if type is set to "HTTP agent" and allow_traps is set to "Allow to accept incoming data"
username	string	Username for authentication. Property behavior: - required if type is set to "SSH agent", "TELNET agent", or if type is set to "JMX agent" and password is set - supported if type is set to "Simple check", "Database monitor", or "HTTP agent" - read-only for inherited objects (if type is set to "HTTP agent")
uuid	string	Universal unique identifier, used for linking imported LLD rules to already existing ones. Auto-generated, if not given. Property behavior: - supported if the LLD rule belongs to a template
verify_host	integer	Whether to validate that the host name for the connection matches the one in the host's certificate. Possible values: 0 - (default) Do not validate; 1 - Validate. Property behavior: - supported if type is set to "HTTP agent" - read-only for inherited objects

Property	Type	Description
verify_peer	integer	Whether to validate that the host's certificate is authentic. Possible values: 0 - (default) Do not validate; 1 - Validate. Property behavior: - <i>supported</i> if type is set to "HTTP agent" - <i>read-only</i> for inherited objects

HTTP header

The header object has the following properties:

Property	Type	Description
name	string	HTTP header name. Property behavior: - <i>required</i>
value	string	Header value. Property behavior: - <i>required</i>

HTTP query field

The query field object defines a name and value that is used to specify a URL parameter. It has the following properties:

Property	Type	Description
name	string	Name of the parameter. Property behavior: - <i>required</i>
value	string	Parameter value. Property behavior: - <i>required</i>

LLD rule filter

The LLD rule filter object defines a set of conditions that can be used to filter discovered objects. It has the following properties:

Property	Type	Description
conditions	object/array	Set of filter conditions to use for filtering results. The conditions will be sorted in the order of their placement in the formula. Property behavior: - <i>required</i>
evaltype	integer	Filter condition evaluation method. Possible values: 0 - and/or; 1 - and; 2 - or; 3 - custom expression. Property behavior: - <i>required</i>

Property	Type	Description
eval_formula	string	Generated expression that will be used for evaluating filter conditions. The expression contains IDs that reference specific filter conditions by its formulaid. The value of eval_formula is equal to the value of formula for filters with a custom expression.
formula	string	<p>User-defined expression to be used for evaluating conditions of filters with a custom expression. The expression must contain IDs that reference specific filter conditions by its formulaid. The IDs used in the expression must exactly match the ones defined in the filter conditions: no condition can remain unused or omitted.</p> <p>Property behavior:</p> <ul style="list-style-type: none"> - <i>read-only</i> <p>Property behavior:</p> <ul style="list-style-type: none"> - <i>required</i> if evaltype is set to "custom expression"

LLD rule filter condition

The LLD rule filter condition object defines a separate check to perform on the value of an LLD macro. It has the following properties:

Property	Type	Description
macro	string	LLD macro to perform the check on.
value	string	<p>Value to compare with.</p> <p>Property behavior:</p> <ul style="list-style-type: none"> - <i>required</i>
formulaid	string	<p>Arbitrary unique ID that is used to reference the condition from a custom expression. Can only contain capital-case letters. The ID must be defined by the user when modifying filter conditions, but will be generated anew when requesting them afterward.</p> <p>Property behavior:</p> <ul style="list-style-type: none"> - <i>required</i> if operator is set to "matches regular expression" or "does not match regular expression"
operator	integer	<p>Condition operator.</p> <p>Possible values:</p> <ul style="list-style-type: none"> 8 - (<i>default</i>) matches regular expression; 9 - does not match regular expression; 12 - exists; 13 - does not exist.

Note:

To better understand how to use filters with various types of expressions, see examples on the [discoveryrule.get](#) and [discoveryrule.create](#) method pages.

LLD macro path

The LLD macro path has the following properties:

Property	Type	Description
lld_macro	string	LLD macro.
path	string	<p>Property behavior: - <i>required</i></p> <p>Selector for value which will be assigned to corresponding macro.</p> <p>Property behavior: - <i>required</i></p>

LLD rule preprocessing

The LLD rule preprocessing object has the following properties.

Property	Type	Description
type	integer	<p>The preprocessing option type.</p> <p>Possible values: 5 - Regular expression; 11 - XML XPath; 12 - JSONPath; 14 - Matches regular expression; 15 - Does not match regular expression; 16 - Check for error in JSON; 17 - Check for error in XML; 20 - Discard unchanged with heartbeat; 21 - JavaScript; 23 - Prometheus to JSON; 24 - CSV to JSON; 25 - Replace; 27 - XML to JSON; 28 - SNMP walk value; 29 - SNMP walk to JSON; 30 - SNMP get value.</p> <p>Property behavior: - <i>required</i></p>
params	string	<p>Additional parameters used by preprocessing option. Multiple parameters are separated by the newline (\n) character.</p> <p>Property behavior: - <i>required</i> if type is set to "Regular expression" (5), "XML XPath" (11), "JSONPath" (12), "Matches regular expression" (14), "Does not match regular expression" (15), "Check for error in JSON" (16), "Check for error in XML" (17), "Discard unchanged with heartbeat" (20), "JavaScript" (21), "Prometheus to JSON" (23), "CSV to JSON" (24), "Replace" (25), "SNMP walk value" (28), "SNMP walk to JSON" (29), or "SNMP get value" (30)</p>

Property	Type	Description
error_handler	integer	<p>Action type used in case of preprocessing step failure.</p> <p>Possible values:</p> <ul style="list-style-type: none"> 0 - Error message is set by Zabbix server; 1 - Discard value; 2 - Set custom value; 3 - Set custom error message. <p>Property behavior:</p> <ul style="list-style-type: none"> - <i>required</i> if type is set to "Regular expression" (5), "XML XPath" (11), "JSONPath" (12), "Matches regular expression" (14), "Does not match regular expression" (15), "Check for error in JSON" (16), "Check for error in XML" (17), "Prometheus to JSON" (23), "CSV to JSON" (24), "XML to JSON" (27), "SNMP walk value" (28), "SNMP walk to JSON" (29), or "SNMP get value" (30)
error_handler_params	string	<p>Error handler parameters.</p> <p>Property behavior:</p> <ul style="list-style-type: none"> - <i>required</i> if error_handler is set to "Set custom value" or "Set custom error message"

The following parameters and error handlers are supported for each preprocessing type.

Preprocessing type	Name	Parameter 1	Parameter 2	Parameter 3	Supported error handlers
5	Regular expression	pattern ¹	output ²		0, 1, 2, 3
11	XML XPath	path ³			0, 1, 2, 3
12	JSONPath	path ³			0, 1, 2, 3
14	Matches regular expression	pattern ¹			0, 1, 2, 3
15	Does not match regular expression	pattern ¹			0, 1, 2, 3
16	Check for error in JSON	path ³			0, 1, 2, 3
17	Check for error in XML	path ³			0, 1, 2, 3

Preprocessing type	Name	Parameter 1	Parameter 2	Parameter 3	Supported error handlers
20	Discard seconds ^{4, 5} un- changed with heart- beat				
21	JavaScript ²				
23	Prometheus ^{5, 6} to JSON				0, 1, 2, 3
24	CSV to JSON	character ²	character ²	0,1	0, 1, 2, 3
25	Replace search string ²		replacement ²		
27	XML to JSON				0, 1, 2, 3
28	SNMP walk value	OID ²	Format: 0 - Unchanged 1 - UTF-8 from Hex-STRING 2 - MAC from Hex-STRING 3 - Integer from BITS		0, 1, 2, 3
29	SNMP walk to JSON ⁷	Field name ²	OID prefix ²	Format: 0 - Unchanged 1 - UTF-8 from Hex-STRING 2 - MAC from Hex-STRING 3 - Integer from BITS	0, 1, 2, 3
30	SNMP get value	Format: 1 - UTF-8 from Hex-STRING 2 - MAC from Hex-STRING 3 - Integer from BITS			0, 1, 2, 3

¹ regular expression

² string

³ JSONPath or XML XPath

⁴ positive integer (with support of time suffixes, e.g. 30s, 1m, 2h, 1d)

⁵ user macro

⁶ Prometheus pattern following the syntax: <metric name>{<label name>=<label value>, ...} == <value>. Each Prometheus pattern component (metric, label name, label value and metric value) can be user macro.

⁷ Supports multiple "Field name,OID prefix,Format records" records delimited by a new line character.

LLD rule overrides

The LLD rule overrides object defines a set of rules (filters, conditions and operations) that are used to override properties of different prototype objects. It has the following properties:

Property	Type	Description
name	string	Unique override name.

Property behavior:
- *required*

Property	Type	Description
step	integer	Unique order number of the override.
stop	integer	<p>Property behavior: - <i>required</i></p> <p>Stop processing next overrides if matches.</p> <p>Possible values: 0 - (<i>default</i>) don't stop processing overrides; 1 - stop processing overrides if filter matches.</p>
filter	object	Override filter.
operations	object/array	Override operations.

LLD rule override filter

The LLD rule override filter object defines a set of conditions that if they match the discovered object the override is applied. It has the following properties:

Property	Type	Description
conditions	object/array	Set of override filter conditions to use for matching the discovered objects. The conditions will be sorted in the order of their placement in the formula.
evaltype	integer	<p>Property behavior: - <i>required</i></p> <p>Override filter condition evaluation method.</p> <p>Possible values: 0 - and/or; 1 - and; 2 - or; 3 - custom expression.</p>
eval_formula	string	<p>Property behavior: - <i>required</i></p> <p>Generated expression that will be used for evaluating override filter conditions. The expression contains IDs that reference specific override filter conditions by its <code>formulaid</code>. The value of <code>eval_formula</code> is equal to the value of <code>formula</code> for filters with a custom expression.</p>
formula	string	<p>Property behavior: - <i>read-only</i></p> <p>User-defined expression to be used for evaluating conditions of override filters with a custom expression. The expression must contain IDs that reference specific override filter conditions by its <code>formulaid</code>. The IDs used in the expression must exactly match the ones defined in the override filter conditions: no condition can remain unused or omitted.</p> <p>Property behavior: - <i>required</i> if <code>evaltype</code> is set to "custom expression"</p>

LLD rule override filter condition

The LLD rule override filter condition object defines a separate check to perform on the value of an LLD macro. It has the following properties:

Property	Type	Description
macro	string	LLD macro to perform the check on.
value	string	<p>Property behavior: - <i>required</i> Value to compare with.</p> <p>Property behavior: - <i>required</i> if <code>operator</code> is set to "matches regular expression" or "does not match regular expression"</p>
formulaid	string	<p>Arbitrary unique ID that is used to reference the condition from a custom expression. Can only contain capital-case letters. The ID must be defined by the user when modifying filter conditions, but will be generated anew when requesting them afterward.</p> <p>Property behavior: - <i>required</i> if <code>evaltype</code> of <code>LLD rule override filter object</code> is set to "custom expression"</p>
operator	integer	<p>Condition operator.</p> <p>Possible values: 8 - (<i>default</i>) matches regular expression; 9 - does not match regular expression; 12 - exists; 13 - does not exist.</p>

LLD rule override operation

The LLD rule override operation is combination of conditions and actions to perform on the prototype object. It has the following properties:

Property	Type	Description
operationobject	integer	<p>Type of discovered object to perform the action.</p> <p>Possible values: 0 - Item prototype; 1 - Trigger prototype; 2 - Graph prototype; 3 - Host prototype.</p>
operator	integer	<p>Property behavior: - <i>required</i> Override condition operator.</p> <p>Possible values: 0 - (<i>default</i>) equals; 1 - does not equal; 2 - contains; 3 - does not contain; 8 - matches; 9 - does not match.</p>
value	string	Pattern to match item, trigger, graph or host prototype name depending on selected object.
opstatus	object	Override operation status object for item, trigger and host prototype objects.
opdiscover	object	Override operation discover status object (all object types).
opperiod	object	Override operation period (update interval) object for item prototype object.
ophistory	object	Override operation history object for item prototype object.
optrends	object	Override operation trends object for item prototype object.
opseverity	object	Override operation severity object for trigger prototype object.

Property	Type	Description
optag	object/array	Override operation tag object for trigger and host prototype objects.
optemplate	object/array	Override operation template object for host prototype object.
opinVENTORY	object	Override operation inventory object for host prototype object.

LLD rule override operation status

LLD rule override operation status that is set to discovered object. It has the following properties:

Property	Type	Description
status	integer	Override the status for selected object. Possible values: 0 - Create enabled; 1 - Create disabled. Property behavior: - <i>required</i>

LLD rule override operation discover

LLD rule override operation discover status that is set to discovered object. It has the following properties:

Property	Type	Description
discover	integer	Override the discover status for selected object. Possible values: 0 - Yes, continue discovering the objects; 1 - No, new objects will not be discovered and existing ones will be marked as lost. Property behavior: - <i>required</i>

LLD rule override operation period

LLD rule override operation period is an update interval value that is set to discovered item. It has the following properties:

Property	Type	Description
delay	string	Override the update interval of the item prototype. Accepts seconds or time unit with suffix (e.g., 30s, 1m, 2h, 1d) and, optionally, one or more custom intervals , all separated by semicolons. Custom intervals can be a mix of flexible and scheduling intervals. Accepts user macros or LLD macros. If used, the value must be a single macro. Multiple macros or macros mixed with text are not supported. Flexible intervals may be written as two macros separated by a forward slash (e.g., <code>{FLEX_INTERVAL}/{FLEX_PERIOD}</code>). Example: 1h;wd1-5h9-18;{Macro1}/1-7,00:00-24:00;0/6-7,12:00-24:00;{Macro2} Property behavior: - <i>required</i>

LLD rule override operation history

LLD rule override operation history value that is set to discovered item. It has the following properties:

Property	Type	Description
history	string	Override the history of item prototype which is a time unit of how long the history data should be stored. Also accepts user macro and LLD macro.
Property behavior: - required		

LLD rule override operation trends

LLD rule override operation trends value that is set to discovered item. It has the following properties:

Property	Type	Description
trends	string	Override the trends of item prototype which is a time unit of how long the trends data should be stored. Also accepts user macro and LLD macro.
Property behavior: - required		

LLD rule override operation severity

LLD rule override operation severity value that is set to discovered trigger. It has the following properties:

Property	Type	Description
severity	integer	Override the severity of trigger prototype.
Possible values: 0 - (<i>default</i>) not classified; 1 - information; 2 - warning; 3 - average; 4 - high; 5 - disaster.		
Property behavior: - required		

LLD rule override operation tag

LLD rule override operation tag object contains tag name and value that are set to discovered object. It has the following properties:

Property	Type	Description
tag	string	New tag name.
Property behavior: - required		
value	string	New tag value.

LLD rule override operation template

LLD rule override operation template object that is linked to discovered host. It has the following properties:

Property	Type	Description
templateid	ID	Override the template of host prototype linked templates.
Property behavior: - required		

LLD rule override operation inventory

LLD rule override operation inventory mode value that is set to discovered host. It has the following properties:

Property	Type	Description
inventory_mode	integer	Override the host prototype inventory mode. Possible values: -1 - disabled; 0 - (<i>default</i>) manual; 1 - automatic. Property behavior: - <i>required</i>

discoveryrule.create

Description

object discoveryrule.create(object/array lldRules)

This method allows to create new LLD rules.

Note:

This method is only available to *Admin* and *Super admin* user types. Permissions to call the method can be revoked in user role settings. See **User roles** for more information.

Parameters

(object/array) LLD rules to create.

Additionally to the **standard LLD rule properties**, the method accepts the following parameters.

Parameter	Type	Description
filter	object	LLD rule filter for the LLD rule.
preprocessing	object/array	LLD rule preprocessing options.
lld_macro_paths	object/array	LLD rule lld_macro_path options.
overrides	object/array	LLD rule overrides options.

Return values

(object) Returns an object containing the IDs of the created LLD rules under the `itemids` property. The order of the returned IDs matches the order of the passed LLD rules.

Examples

Creating an LLD rule

Create a Zabbix agent LLD rule to discover mounted file systems. Discovered items will be updated every 30 seconds.

Request:

```
{
  "jsonrpc": "2.0",
  "method": "discoveryrule.create",
  "params": {
    "name": "Mounted filesystem discovery",
    "key_": "vfs.fs.discovery",
    "hostid": "10197",
    "type": 0,
    "interfaceid": "112",
    "delay": "30s"
  },
  "id": 1
}
```

Response:

```
{
  "jsonrpc": "2.0",
  "result": {
    "itemids": [
      "27665"
    ]
  },
  "id": 1
}
```

Using a filter

Create an LLD rule with a set of conditions to filter the results by. The conditions will be grouped together using the logical "and" operator.

Request:

```
{
  "jsonrpc": "2.0",
  "method": "discoveryrule.create",
  "params": {
    "name": "Filtered LLD rule",
    "key_": "lld",
    "hostid": "10116",
    "type": 0,
    "interfaceid": "13",
    "delay": "30s",
    "filter": {
      "evaltype": 1,
      "conditions": [
        {
          "macro": "#{MACRO1}",
          "value": "@regex1"
        },
        {
          "macro": "#{MACRO2}",
          "value": "@regex2",
          "operator": "9"
        },
        {
          "macro": "#{MACRO3}",
          "value": "",
          "operator": "12"
        },
        {
          "macro": "#{MACRO4}",
          "value": "",
          "operator": "13"
        }
      ]
    }
  },
  "id": 1
}
```

Response:

```
{
  "jsonrpc": "2.0",
  "result": {
    "itemids": [
      "27665"
    ]
  },
}
```

```
"id": 1
}
```

Creating an LLD rule with macro paths

Request:

```
{
  "jsonrpc": "2.0",
  "method": "discoveryrule.create",
  "params": {
    "name": "LLD rule with LLD macro paths",
    "key_": "lld",
    "hostid": "10116",
    "type": 0,
    "interfaceid": "13",
    "delay": "30s",
    "lld_macro_paths": [
      {
        "lld_macro": "#{MACRO1}",
        "path": "$.path.1"
      },
      {
        "lld_macro": "#{MACRO2}",
        "path": "$.path.2"
      }
    ]
  },
  "id": 1
}
```

Response:

```
{
  "jsonrpc": "2.0",
  "result": {
    "itemids": [
      "27665"
    ]
  },
  "id": 1
}
```

Using a custom expression filter

Create an LLD rule with a filter that will use a custom expression to evaluate the conditions. The LLD rule must only discover objects the "#{MACRO1}" macro value of which matches both regular expression "regex1" and "regex2", and the value of "#{MACRO2}" matches either "regex3" or "regex4". The formula IDs "A", "B", "C" and "D" have been chosen arbitrarily.

Request:

```
{
  "jsonrpc": "2.0",
  "method": "discoveryrule.create",
  "params": {
    "name": "Filtered LLD rule",
    "key_": "lld",
    "hostid": "10116",
    "type": 0,
    "interfaceid": "13",
    "delay": "30s",
    "filter": {
      "evaltype": 3,
      "formula": "(A and B) and (C or D)",
      "conditions": [
        {
          "macro": "#{MACRO1}",

```

```

        "value": "@regex1",
        "formulaid": "A"
    },
    {
        "macro": "#{MACRO1}",
        "value": "@regex2",
        "formulaid": "B"
    },
    {
        "macro": "#{MACRO2}",
        "value": "@regex3",
        "formulaid": "C"
    },
    {
        "macro": "#{MACRO2}",
        "value": "@regex4",
        "formulaid": "D"
    }
]
},
"id": 1
}

```

Response:

```

{
  "jsonrpc": "2.0",
  "result": {
    "itemids": [
      "27665"
    ]
  },
  "id": 1
}

```

Using custom query fields and headers

Create LLD rule with custom query fields and headers.

Request:

```

{
  "jsonrpc": "2.0",
  "method": "discoveryrule.create",
  "params": {
    "hostid": "10257",
    "interfaceid": "5",
    "type": 19,
    "name": "API HTTP agent",
    "key_": "api_discovery_rule",
    "value_type": 3,
    "delay": "5s",
    "url": "http://127.0.0.1?discoverer.php",
    "query_fields": [
      {
        "name": "mode",
        "value": "json"
      },
      {
        "name": "elements",
        "value": "2"
      }
    ],
    "headers": [

```

```

    {
      "name": "X-Type",
      "value": "api"
    },
    {
      "name": "Authorization",
      "value": "Bearer mF_A.B5f-2.1JcM"
    }
  ],
  "allow_traps": 1,
  "trapper_hosts": "127.0.0.1"
},
"id": 1
}

```

Response:

```

{
  "jsonrpc": "2.0",
  "result": {
    "itemids": [
      "28336"
    ]
  },
  "id": 1
}

```

Creating an LLD rule with preprocessing

Request:

```

{
  "jsonrpc": "2.0",
  "method": "discoveryrule.create",
  "params": {
    "name": "Discovery rule with preprocessing",
    "key_": "lld.with.preprocessing",
    "hostid": "10001",
    "ruleid": "27665",
    "type": 0,
    "value_type": 3,
    "delay": "60s",
    "interfaceid": "1155",
    "preprocessing": [
      {
        "type": 20,
        "params": "20",
        "error_handler": 0,
        "error_handler_params": ""
      }
    ]
  },
  "id": 1
}

```

Response:

```

{
  "jsonrpc": "2.0",
  "result": {
    "itemids": [
      "44211"
    ]
  },
  "id": 1
}

```

```
}
```

Creating an LLD rule with overrides

Request:

```
{
  "jsonrpc": "2.0",
  "method": "discoveryrule.create",
  "params": {
    "name": "Discover database host",
    "key_": "lld.with.overrides",
    "hostid": "10001",
    "type": 0,
    "value_type": 3,
    "delay": "60s",
    "interfaceid": "1155",
    "overrides": [
      {
        "name": "Discover MySQL host",
        "step": "1",
        "stop": "1",
        "filter": {
          "evaltype": "2",
          "conditions": [
            {
              "macro": "{#UNIT.NAME}",
              "operator": "8",
              "value": "~mysqld\\.service$"
            },
            {
              "macro": "{#UNIT.NAME}",
              "operator": "8",
              "value": "~mariadb\\.service$"
            }
          ]
        },
        "operations": [
          {
            "operationobject": "3",
            "operator": "2",
            "value": "Database host",
            "opstatus": {
              "status": "0"
            },
            "optemplate": [
              {
                "templateid": "10170"
              }
            ],
            "optag": [
              {
                "tag": "database",
                "value": "mysql"
              }
            ]
          }
        ]
      }
    ],
    {
      "name": "Discover PostgreSQL host",
      "step": "2",
      "stop": "1",
      "filter": {
```

```

        "evaltype": "0",
        "conditions": [
            {
                "macro": "#{UNIT.NAME}",
                "operator": "8",
                "value": "~postgresql\\.service$"
            }
        ]
    },
    "operations": [
        {
            "operationobject": "3",
            "operator": "2",
            "value": "Database host",
            "opstatus": {
                "status": "0"
            },
            "optemplate": [
                {
                    "templateid": "10263"
                }
            ],
            "optag": [
                {
                    "tag": "database",
                    "value": "postgresql"
                }
            ]
        }
    ]
}
]
},
"id": 1
}

```

Response:

```

{
    "jsonrpc": "2.0",
    "result": {
        "itemids": [
            "30980"
        ]
    },
    "id": 1
}

```

Create script LLD rule

Create a simple data collection using a script LLD rule.

Request:

```

{
    "jsonrpc": "2.0",
    "method": "discoveryrule.create",
    "params": {
        "name": "Script example",
        "key_": "custom.script.lldrule",
        "hostid": "12345",
        "type": 21,
        "value_type": 4,
        "params": "var request = new HttpRequest();\nreturn request.post(\"https://postman-echo.com/post\");",
        "parameters": [{"

```

```

        "name": "host",
        "value": "{HOST.CONN}"
    }],
    "timeout": "6s",
    "delay": "30s"
},
"id": 1
}

```

Response:

```

{
  "jsonrpc": "2.0",
  "result": {
    "itemids": [
      "23865"
    ]
  },
  "id": 1
}

```

Create LLD rule with a specified time period for disabling and no deletion

Create an LLD rule with custom time period for disabling entity after it is no longer discovered, with the setting that it will never be deleted.

Request:

```

{
  "jsonrpc": "2.0",
  "method": "discoveryrule.create",
  "params": {
    "name": "lld disable after 1h",
    "key_": "lld.disable",
    "hostid": "10001",
    "type": 2,
    "lifetime_type": 1,
    "enabled_lifetime_type": 0,
    "enabled_lifetime": "1h"
  },
  "id": 1
}

```

Response:

```

{
  "jsonrpc": "2.0",
  "result": {
    "itemids": [
      "46864"
    ]
  },
  "id": 1
}

```

See also

- [LLD rule filter](#)
- [LLD macro paths](#)
- [LLD rule preprocessing](#)

Source

`CDiscoveryRule::create()` in `ui/include/classes/api/services/CDiscoveryRule.php`.

discoveryrule.delete

Description

`object discoveryrule.delete(array lldRuleIds)`

This method allows to delete LLD rules.

Note:

This method is only available to *Admin* and *Super admin* user types. Permissions to call the method can be revoked in user role settings. See [User roles](#) for more information.

Parameters

(array) IDs of the LLD rules to delete.

Return values

(object) Returns an object containing the IDs of the deleted LLD rules under the `ruleids` property.

Examples

Deleting multiple LLD rules

Delete two LLD rules.

Request:

```
{
  "jsonrpc": "2.0",
  "method": "discoveryrule.delete",
  "params": [
    "27665",
    "27668"
  ],
  "id": 1
}
```

Response:

```
{
  "jsonrpc": "2.0",
  "result": {
    "ruleids": [
      "27665",
      "27668"
    ]
  },
  "id": 1
}
```

Source

`CDiscoveryRule::delete()` in `ui/include/classes/api/services/CDiscoveryRule.php`.

discoveryrule.get

Description

`integer/array discoveryrule.get(object parameters)`

The method allows to retrieve LLD rules according to the given parameters.

Note:

This method is available to users of any type. Permissions to call the method can be revoked in user role settings. See [User roles](#) for more information.

Parameters

(object) Parameters defining the desired output.

The method supports the following parameters.

Parameter	Type	Description
itemids	ID/array	Return only LLD rules with the given IDs.
groupids	ID/array	Return only LLD rules that belong to the hosts from the given groups.
hostids	ID/array	Return only LLD rules that belong to the given hosts.
inherited	boolean	If set to true return only LLD rules inherited from a template.
interfaceids	ID/array	Return only LLD rules use the given host interfaces.
monitored	boolean	If set to true return only enabled LLD rules that belong to monitored hosts.
templated	boolean	If set to true return only LLD rules that belong to templates.
templateids	ID/array	Return only LLD rules that belong to the given templates.
selectFilter	query	Return a filter property with data of the filter used by the LLD rule.
selectGraphs	query	Returns a graphs property with graph prototypes that belong to the LLD rule.
selectHostPrototypes	query	Supports count. Return a hostPrototypes property with host prototypes that belong to the LLD rule.
selectHosts	query	Supports count. Return a hosts property with an array of hosts that the LLD rule belongs to.
selectItems	query	Return an items property with item prototypes that belong to the LLD rule.
selectTriggers	query	Supports count. Return a triggers property with trigger prototypes that belong to the LLD rule.
selectLLDMacroPaths	query	Supports count. Return an lld_macro_paths property with a list of LLD macros and paths to values assigned to each corresponding macro.
selectPreprocessing	query	Return a preprocessing property with LLD rule preprocessing options.
selectOverrides	query	Return an lld_rule_overrides property with a list of override filters, conditions and operations that are performed on prototype objects.
filter	object	Return only those results that exactly match the given filter. Accepts an object, where the keys are property names, and the values are either a single value or an array of values to match against. Does not support properties of text data type .
limitSelects	integer	Supports additional properties: host - technical name of the host that the LLD rule belongs to. Limits the number of records returned by subselects.
sortfield	string/array	Applies to the following subselects: selectItems , selectGraphs , selectTriggers . Sort the result by the given properties.
countOutput	boolean	Possible values: itemid , name , key_ , delay , type , status . These parameters being common for all get methods are described in detail in the reference commentary .
editable	boolean	
excludeSearch	boolean	
limit	integer	
output	query	
preservekeys	boolean	
search	object	
searchByAny	boolean	
searchWildcardsEnabled	boolean	

Parameter	Type	Description
sortorder	string/array	
startSearch	boolean	

Return values

(integer/array) Returns either:

- an array of objects;
- the count of retrieved objects, if the countOutput parameter has been used.

Examples

Retrieving discovery rules from a host

Retrieve all discovery rules for specific host ID.

Request:

```
{
  "jsonrpc": "2.0",
  "method": "discoveryrule.get",
  "params": {
    "output": "extend",
    "hostids": "10202"
  },
  "id": 1
}
```

Response:

```
{
  "jsonrpc": "2.0",
  "result": [
    {
      "itemid": "27425",
      "type": "0",
      "snmp_oid": "",
      "hostid": "10202",
      "name": "Network interface discovery",
      "key_": "net.if.discovery",
      "delay": "1h",
      "status": "0",
      "trapper_hosts": "",
      "templateid": "22444",
      "valuemapid": "0",
      "params": "",
      "ipmi_sensor": "",
      "authtype": "0",
      "username": "",
      "password": "",
      "publickey": "",
      "privatekey": "",
      "interfaceid": "119",
      "description": "Discovery of network interfaces as defined in global regular expression \"Netw",
      "lifetime": "30d",
      "jmx_endpoint": "",
      "master_itemid": "0",
      "timeout": "",
      "url": "",
      "query_fields": [],
      "posts": "",
      "status_codes": "200",
      "follow_redirects": "1",
      "post_type": "0",
      "http_proxy": ""
    }
  ]
}
```

```

    "headers": [],
    "retrieve_mode": "0",
    "request_method": "0",
    "ssl_cert_file": "",
    "ssl_key_file": "",
    "ssl_key_password": "",
    "verify_peer": "0",
    "verify_host": "0",
    "allow_traps": "0",
    "uuid": "",
    "lifetime_type": "0",
    "enabled_lifetime_type": "2",
    "enabled_lifetime": "0",
    "state": "0",
    "error": "",
    "parameters": []
  },
  {
    "itemid": "27426",
    "type": "0",
    "snmp_oid": "",
    "hostid": "10202",
    "name": "Mounted filesystem discovery",
    "key_": "vfs.fs.discovery",
    "delay": "1h",
    "status": "0",
    "trapper_hosts": "",
    "templateid": "22450",
    "valuemapid": "0",
    "params": "",
    "ipmi_sensor": "",
    "authtype": "0",
    "username": "",
    "password": "",
    "publickey": "",
    "privatekey": "",
    "interfaceid": "119",
    "description": "Discovery of file systems of different types as defined in global regular expressions",
    "lifetime": "30d",
    "jmx_endpoint": "",
    "master_itemid": "0",
    "timeout": "",
    "url": "",
    "query_fields": [],
    "posts": "",
    "status_codes": "200",
    "follow_redirects": "1",
    "post_type": "0",
    "http_proxy": "",
    "headers": [],
    "retrieve_mode": "0",
    "request_method": "0",
    "ssl_cert_file": "",
    "ssl_key_file": "",
    "ssl_key_password": "",
    "verify_peer": "0",
    "verify_host": "0",
    "allow_traps": "0",
    "uuid": "",
    "lifetime_type": "0",
    "enabled_lifetime_type": "2",
    "enabled_lifetime": "0",

```

```

        "state": "0",
        "error": "",
        "parameters": []
    }
],
    "id": 1
}

```

Retrieving filter conditions

Retrieve the name of the LLD rule "24681" and its filter conditions. The filter uses the "and" evaluation type, so the formula property is empty and eval_formula is generated automatically.

Request:

```

{
    "jsonrpc": "2.0",
    "method": "discoveryrule.get",
    "params": {
        "output": ["name"],
        "selectFilter": "extend",
        "itemids": ["24681"]
    },
    "id": 1
}

```

Response:

```

{
    "jsonrpc": "2.0",
    "result": [
        {
            "itemid": "24681",
            "name": "Filtered LLD rule",
            "filter": {
                "evaltype": "1",
                "formula": "",
                "conditions": [
                    {
                        "macro": "#{MACRO1}",
                        "value": "@regex1",
                        "operator": "8",
                        "formulaid": "A"
                    },
                    {
                        "macro": "#{MACRO2}",
                        "value": "@regex2",
                        "operator": "9",
                        "formulaid": "B"
                    },
                    {
                        "macro": "#{MACRO3}",
                        "value": "",
                        "operator": "12",
                        "formulaid": "C"
                    },
                    {
                        "macro": "#{MACRO4}",
                        "value": "",
                        "operator": "13",
                        "formulaid": "D"
                    }
                ],
                "eval_formula": "A and B and C and D"
            }
        ]
    }
}

```

```
    }  
  ],  
  "id": 1  
}
```

Retrieve LLD rule by URL

Retrieve LLD rule for host by rule URL field value. Only exact match of URL string defined for LLD rule is supported.

Request:

```
{  
  "jsonrpc": "2.0",  
  "method": "discoveryrule.get",  
  "params": {  
    "hostids": "10257",  
    "filter": {  
      "type": 19,  
      "url": "http://127.0.0.1/discoverer.php"  
    }  
  },  
  "id": 1  
}
```

Response:

```
{  
  "jsonrpc": "2.0",  
  "result": [  
    {  
      "itemid": "28336",  
      "type": "19",  
      "snmp_oid": "",  
      "hostid": "10257",  
      "name": "API HTTP agent",  
      "key_": "api_discovery_rule",  
      "delay": "5s",  
      "status": "0",  
      "trapper_hosts": "",  
      "templateid": "0",  
      "valuemapid": "0",  
      "params": "",  
      "ipmi_sensor": "",  
      "authtype": "0",  
      "username": "",  
      "password": "",  
      "publickey": "",  
      "privatekey": "",  
      "interfaceid": "5",  
      "description": "",  
      "lifetime": "30d",  
      "jmx_endpoint": "",  
      "master_itemid": "0",  
      "timeout": "",  
      "url": "http://127.0.0.1/discoverer.php",  
      "query_fields": [  
        {  
          "name": "mode",  
          "value": "json"  
        },  
        {  
          "name": "elements",  
          "value": "2"  
        }  
      ],  
    }  
  ],  
}
```

```

    "posts": "",
    "status_codes": "200",
    "follow_redirects": "1",
    "post_type": "0",
    "http_proxy": "",
    "headers": [
      {
        "name": "X-Type",
        "value": "api"
      },
      {
        "name": "Authorization",
        "value": "Bearer mF_A.B5f-2.1JcM"
      }
    ],
    "retrieve_mode": "0",
    "request_method": "1",
    "ssl_cert_file": "",
    "ssl_key_file": "",
    "ssl_key_password": "",
    "verify_peer": "0",
    "verify_host": "0",
    "allow_traps": "0",
    "uuid": "",
    "lifetime_type": "0",
    "enabled_lifetime_type": "2",
    "enabled_lifetime": "0",
    "state": "0",
    "error": "",
    "parameters": []
  }
],
  "id": 1
}

```

Retrieve LLD rule with overrides

Retrieve one LLD rule that has various override settings.

Request:

```

{
  "jsonrpc": "2.0",
  "method": "discoveryrule.get",
  "params": {
    "output": ["name"],
    "itemids": "30980",
    "selectOverrides": ["name", "step", "stop", "filter", "operations"]
  },
  "id": 1
}

```

Response:

```

{
  "jsonrpc": "2.0",
  "result": [
    {
      "name": "Discover database host",
      "overrides": [
        {
          "name": "Discover MySQL host",
          "step": "1",
          "stop": "1",
          "filter": {

```

```

    "evaltype": "2",
    "formula": "",
    "conditions": [
      {
        "macro": "{#UNIT.NAME}",
        "operator": "8",
        "value": "~mysqld\\.service$",
        "formulaid": "A"
      },
      {
        "macro": "{#UNIT.NAME}",
        "operator": "8",
        "value": "~mariadb\\.service$",
        "formulaid": "B"
      }
    ],
    "eval_formula": "A or B"
  },
  "operations": [
    {
      "operationobject": "3",
      "operator": "2",
      "value": "Database host",
      "opstatus": {
        "status": "0"
      },
      "optag": [
        {
          "tag": "database",
          "value": "mysql"
        }
      ],
      "optemplate": [
        {
          "templateid": "10170"
        }
      ]
    }
  ]
},
{
  "name": "Discover PostgreSQL host",
  "step": "2",
  "stop": "1",
  "filter": {
    "evaltype": "0",
    "formula": "",
    "conditions": [
      {
        "macro": "{#UNIT.NAME}",
        "operator": "8",
        "value": "~postgresql\\.service$",
        "formulaid": "A"
      }
    ],
    "eval_formula": "A"
  },
  "operations": [
    {
      "operationobject": "3",
      "operator": "2",
      "value": "Database host",

```



```

        "opstatus": {
            "status": "0"
        },
        "optag": [
            {
                "tag": "database",
                "value": "postgresql"
            }
        ],
        "optemplate": [
            {
                "templateid": "10263"
            }
        ]
    }
]
}
],
    "id": 1
}
}

```

See also

- [Graph prototype](#)
- [Host](#)
- [Item prototype](#)
- [LLD rule filter](#)
- [Trigger prototype](#)

Source

CDDiscoveryRule::get() in `ui/include/classes/api/services/CDDiscoveryRule.php`.

discoveryrule.update

Description

object discoveryrule.update(object/array lldRules)

This method allows to update existing LLD rules.

Note:

This method is only available to *Admin* and *Super admin* user types. Permissions to call the method can be revoked in user role settings. See [User roles](#) for more information.

Parameters

(object/array) LLD rule properties to be updated.

The `itemid` property must be defined for each LLD rule, all other properties are optional. Only the passed properties will be updated, all others will remain unchanged.

Additionally to the [standard LLD rule properties](#), the method accepts the following parameters.

Parameter	Type	Description
filter	object	LLD rule filter to replace the existing filter.
preprocessing	object/array	LLD rule preprocessing options to replace the existing preprocessing options.

Parameter behavior:
 - *read-only* for inherited objects

Parameter	Type	Description
lld_macro_paths	object/array	LLD rule <code>lld_macro_path</code> options to replace the existing <code>lld_macro_path</code> options.
overrides	object/array	<p>Parameter behavior:</p> <ul style="list-style-type: none"> - <i>read-only</i> for inherited objects <p>LLD rule <code>overrides</code> options to replace the existing <code>overrides</code> options.</p> <p>Parameter behavior:</p> <ul style="list-style-type: none"> - <i>read-only</i> for inherited objects

Return values

(object) Returns an object containing the IDs of the updated LLD rules under the `itemids` property.

Examples

Adding a filter to an LLD rule

Add a filter so that the contents of the `{#FSTYPE}` macro would match the `@File systems for discovery` regexp.

Request:

```
{
  "jsonrpc": "2.0",
  "method": "discoveryrule.update",
  "params": {
    "itemid": "22450",
    "filter": {
      "evaltype": 1,
      "conditions": [
        {
          "macro": "{#FSTYPE}",
          "value": "@File systems for discovery"
        }
      ]
    }
  },
  "id": 1
}
```

Response:

```
{
  "jsonrpc": "2.0",
  "result": {
    "itemids": [
      "22450"
    ]
  },
  "id": 1
}
```

Adding LLD macro paths

Request:

```
{
  "jsonrpc": "2.0",
  "method": "discoveryrule.update",
  "params": {
    "itemid": "22450",
    "lld_macro_paths": [
      {
        "lld_macro": "{#MACRO1}",
        "path": "$.json.path"
      }
    ]
  }
}
```

```
    ]
  },
  "id": 1
}
```

Response:

```
{
  "jsonrpc": "2.0",
  "result": {
    "itemids": [
      "22450"
    ]
  },
  "id": 1
}
```

Disable trapping

Disable LLD trapping for discovery rule.

Request:

```
{
  "jsonrpc": "2.0",
  "method": "discoveryrule.update",
  "params": {
    "itemid": "28336",
    "allow_traps": 0
  },
  "id": 1
}
```

Response:

```
{
  "jsonrpc": "2.0",
  "result": {
    "itemids": [
      "28336"
    ]
  },
  "id": 1
}
```

Updating LLD rule preprocessing options

Update an LLD rule with preprocessing rule "JSONPath".

Request:

```
{
  "jsonrpc": "2.0",
  "method": "discoveryrule.update",
  "params": {
    "itemid": "44211",
    "preprocessing": [
      {
        "type": 12,
        "params": "$.path.to.json",
        "error_handler": 2,
        "error_handler_params": "5"
      }
    ]
  },
  "id": 1
}
```

Response:

```
{
  "jsonrpc": "2.0",
  "result": {
    "itemids": [
      "44211"
    ]
  },
  "id": 1
}
```

Updating LLD rule script

Update an LLD rule script with a different script and remove unnecessary parameters that were used by previous script.

Request:

```
{
  "jsonrpc": "2.0",
  "method": "discoveryrule.update",
  "params": {
    "itemid": "23865",
    "parameters": [],
    "script": "Zabbix.log(3, 'Log test');\nreturn 1;"
  },
  "id": 1
}
```

Response:

```
{
  "jsonrpc": "2.0",
  "result": {
    "itemids": [
      "23865"
    ]
  },
  "id": 1
}
```

Updating LLD rule lifetime

Update LLD rule to disable no-longer discovered entity after 12 hours and to delete it after 7 days.

Request:

```
{
  "jsonrpc": "2.0",
  "method": "discoveryrule.update",
  "params": {
    "itemid": "46864",
    "lifetime_type": 0,
    "lifetime": "7d",
    "enabled_lifetime_type": 0,
    "enabled_lifetime": "12h"
  },
  "id": 1
}
```

Response:

```
{
  "jsonrpc": "2.0",
  "result": {
    "itemids": [
      "46864"
    ]
  },
  "id": 1
}
```

```
"id": 1  
}
```

Source

CDiscoveryRule::update() in *ui/include/classes/api/services/CDiscoveryRule.php*.

Maintenance

This class is designed to work with maintenances.

Object references:

- [Maintenance](#)
- [Time period](#)
- [Problem tag](#)

Available methods:

- [maintenance.create](#) - create new maintenances
- [maintenance.delete](#) - delete maintenances
- [maintenance.get](#) - retrieve maintenances
- [maintenance.update](#) - update maintenances

Maintenance object

The following objects are directly related to the `maintenance` API.

Maintenance

The maintenance object has the following properties.

Property	Type	Description
<code>maintenanceid</code>	ID	ID of the maintenance. Property behavior: - <i>read-only</i>
<code>name</code>	string	- <i>required</i> for update operations Name of the maintenance. Property behavior: - <i>required</i> for create operations
<code>active_since</code>	timestamp	Time when the maintenance becomes active. The given value will be rounded down to minutes. Property behavior: - <i>required</i> for create operations
<code>active_till</code>	timestamp	Time when the maintenance stops being active. The given value will be rounded down to minutes. Property behavior: - <i>required</i> for create operations
<code>description</code>	string	Description of the maintenance.
<code>maintenance_type</code>	integer	Type of maintenance. Possible values: 0 - (<i>default</i>) with data collection; 1 - without data collection.

Property	Type	Description
tags_evaltype	integer	Problem tag evaluation method. Possible values: 0 - (default) And/Or; 2 - Or.

Time period

The time period object is used to define periods when the maintenance must come into effect. It has the following properties.

Property	Type	Description
period	integer	Duration of the maintenance period in seconds. The given value will be rounded down to minutes.
timeperiod_type	integer	Default: 3600. Type of time period. Possible values: 0 - (default) one time only; 2 - daily; 3 - weekly; 4 - monthly.
start_date	timestamp	Date when the maintenance period must come into effect. The given value will be rounded down to minutes. Default: current date.
start_time	integer	Property behavior: - <i>supported</i> if timeperiod_type is set to "one time only" Time of day when the maintenance starts in seconds. The given value will be rounded down to minutes. Default: 0. Property behavior: - <i>supported</i> if timeperiod_type is set to "daily", "weekly", or "monthly"

Property	Type	Description
every	integer	<p>For daily and weekly periods every defines the day or week intervals at which the maintenance must come into effect. Default value if <code>timeperiod_type</code> is set to "daily" or "weekly": 1.</p> <p>For monthly periods when <code>day</code> is set, the <code>every</code> property defines the day of the month when the maintenance must come into effect. Default value if <code>timeperiod_type</code> is set to "monthly" and <code>day</code> is set: 1.</p> <p>For monthly periods when <code>dayofweek</code> is set, the <code>every</code> property defines the week of the month when the maintenance must come into effect. Possible values if <code>timeperiod_type</code> is set to "monthly" and <code>dayofweek</code> is set: 1 - (default) first week; 2 - second week; 3 - third week; 4 - fourth week; 5 - last week.</p> <p>Property behavior: - <i>supported</i> if <code>timeperiod_type</code> is set to "daily", "weekly", or "monthly"</p>
dayofweek	integer	<p>Days of the week when the maintenance must come into effect.</p> <p>Possible bitmap values: 1 - Monday; 2 - Tuesday; 4 - Wednesday; 8 - Thursday; 16 - Friday; 32 - Saturday; 64 - Sunday.</p> <p>This is a bitmask field; any sum of possible bitmap values is acceptable (for example, 21 for Monday, Wednesday, and Friday).</p> <p>Property behavior: - <i>required</i> if <code>timeperiod_type</code> is set to "weekly" or if <code>timeperiod_type</code> is set to "monthly" and <code>day</code> is not set</p>
day	integer	<p>Day of the month when the maintenance must come into effect.</p> <p>Property behavior: - <i>required</i> if <code>timeperiod_type</code> is set to "monthly" and <code>dayofweek</code> is not set</p>

Property	Type	Description
month	integer	<p>Months when the maintenance must come into effect.</p> <p>Possible bitmap values: 1 - January; 2 - February; 4 - March; 8 - April; 16 - May; 32 - June; 64 - July; 128 - August; 256 - September; 512 - October; 1024 - November; 2048 - December.</p> <p>This is a bitmask field; any sum of possible bitmap values is acceptable (for example, 585 for January, April, July, and October).</p> <p>Property behavior: - <i>required</i> if <code>timeperiod_type</code> is set to "monthly"</p>

Problem tag

The problem tag object is used to define which problems must be suppressed when the maintenance comes into effect. Tags can only be specified if `maintenance_type` of **Maintenance object** is set to "with data collection". It has the following properties.

Property	Type	Description
tag	string	<p>Problem tag name.</p> <p>Property behavior: - <i>required</i></p>
operator	integer	<p>Condition operator.</p> <p>Possible values: 0 - Equals; 2 - (<i>default</i>) Contains.</p>
value	string	<p>Problem tag value.</p>

maintenance.create

Description

`object maintenance.create(object/array maintenances)`

This method allows to create new maintenances.

Note:

This method is only available to *Admin* and *Super admin* user types. Permissions to call the method can be revoked in user role settings. See **User roles** for more information.

Parameters

(object/array) Maintenances to create.

Additionally to the **standard maintenance properties**, the method accepts the following parameters.

Parameter	Type	Description
groups	object/array	<p>Host groups that will undergo maintenance.</p> <p>The host groups must have only the <code>groupid</code> property defined.</p> <p>Parameter behavior: - <i>required</i> if <code>hosts</code> is not set</p>
hosts	object/array	<p>Hosts that will undergo maintenance.</p> <p>The hosts must have only the <code>hostid</code> property defined.</p> <p>Parameter behavior: - <i>required</i> if <code>groups</code> is not set</p>
timeperiods	object/array	<p>Maintenance time periods.</p> <p>Parameter behavior: - <i>required</i></p>
tags	object/array	<p>Problem tags.</p> <p>Define what problems must be suppressed. If no tags are given, all active maintenance host problems will be suppressed.</p> <p>Parameter behavior: - <i>supported</i> if <code>maintenance_type</code> of Maintenance object is set to "with data collection"</p>

Return values

(object) Returns an object containing the IDs of the created maintenances under the `maintenanceids` property. The order of the returned IDs matches the order of the passed maintenances.

Examples

Creating a maintenance

Create a maintenance with data collection for host group with ID "2" and with problem tags **service:mysql** and **error**. It must be active from 22.01.2013 till 22.01.2014, come in effect each Sunday at 18:00 and last for one hour.

Request:

```
{
  "jsonrpc": "2.0",
  "method": "maintenance.create",
  "params": {
    "name": "Sunday maintenance",
    "active_since": 1358844540,
    "active_till": 1390466940,
    "tags_evaltype": 0,
    "groups": [
      {"groupid": "2"}
    ],
    "timeperiods": [
      {
        "period": 3600,
        "timeperiod_type": 3,
        "start_time": 64800,
        "every": 1,
        "dayofweek": 64
      }
    ],
    "tags": [
      {
        "tag": "service",
        "operator": "0",

```

```
        "value": "mysqlid"
    },
    {
        "tag": "error",
        "operator": "2",
        "value": ""
    }
]
},
"id": 1
}
```

Response:

```
{
  "jsonrpc": "2.0",
  "result": {
    "maintenanceids": [
      "3"
    ]
  },
  "id": 1
}
```

See also

- [Time period](#)

Source

CMaintenance::create() in `ui/include/classes/api/services/CMaintenance.php`.

maintenance.delete

Description

object maintenance.delete(array maintenanceIds)

This method allows to delete maintenance periods.

Note:

This method is only available to *Admin* and *Super admin* user types. Permissions to call the method can be revoked in user role settings. See [User roles](#) for more information.

Parameters

(array) IDs of the maintenance periods to delete.

Return values

(object) Returns an object containing the IDs of the deleted maintenance periods under the `maintenanceids` property.

Examples

Deleting multiple maintenance periods

Delete two maintenance periods.

Request:

```
{
  "jsonrpc": "2.0",
  "method": "maintenance.delete",
  "params": [
    "3",
    "1"
  ],
  "id": 1
}
```

Response:

```
{
  "jsonrpc": "2.0",
  "result": {
    "maintenanceids": [
      "3",
      "1"
    ]
  },
  "id": 1
}
```

Source

CMaintenance::delete() in *ui/include/classes/api/services/CMaintenance.php*.

maintenance.get

Description

integer/array maintenance.get(object parameters)

The method allows to retrieve maintenances according to the given parameters.

Note:

This method is available to users of any type. Permissions to call the method can be revoked in user role settings. See [User roles](#) for more information.

Parameters

(object) Parameters defining the desired output.

The method supports the following parameters.

Parameter	Type	Description
groupids	ID/array	Return only maintenances that are assigned to the given host groups.
hostids	ID/array	Return only maintenances that are assigned to the given hosts.
maintenanceids	ID/array	Return only maintenances with the given IDs.
selectHostGroups	query	Return a hostgroups property with host groups assigned to the maintenance.
selectHosts	query	Return a hosts property with hosts assigned to the maintenance.
selectTags	query	Return a tags property with problem tags of the maintenance.
selectTimeperiods	query	Return a timeperiods property with time periods of the maintenance.
sortfield	string/array	Sort the result by the given properties.
countOutput	boolean	Possible values: <code>maintenanceid</code> , <code>name</code> , <code>maintenance_type</code> . These parameters being common for all get methods are described in detail in the reference commentary .
editable	boolean	
excludeSearch	boolean	
filter	object	
limit	integer	
output	query	
preservekeys	boolean	
search	object	
searchByAny	boolean	
searchWildcardsEnabled	boolean	
sortorder	string/array	
startSearch	boolean	

Return values

(integer/array) Returns either:

- an array of objects;
- the count of retrieved objects, if the countOutput parameter has been used.

Examples

Retrieving maintenances

Retrieve all configured maintenances, and the data about the assigned host groups, defined time periods and problem tags.

Request:

```
{
  "jsonrpc": "2.0",
  "method": "maintenance.get",
  "params": {
    "output": "extend",
    "selectHostGroups": "extend",
    "selectTimeperiods": "extend",
    "selectTags": "extend"
  },
  "id": 1
}
```

Response:

```
{
  "jsonrpc": "2.0",
  "result": [
    {
      "maintenanceid": "3",
      "name": "Sunday maintenance",
      "maintenance_type": "0",
      "description": "",
      "active_since": "1358844540",
      "active_till": "1390466940",
      "tags_evaltype": "0",
      "hostgroups": [
        {
          "groupid": "4",
          "name": "Zabbix servers",
          "flags": "0",
          "uuid": "6f6799aa69e844b4b3918f779f2abf08"
        }
      ],
      "timeperiods": [
        {
          "timeperiod_type": "3",
          "every": "1",
          "month": "0",
          "dayofweek": "1",
          "day": "0",
          "start_time": "64800",
          "period": "3600",
          "start_date": "2147483647"
        }
      ],
      "tags": [
        {
          "tag": "service",
          "operator": "0",
          "value": "mysqld",
        },
        {
          "tag": "error",
          "operator": "2",
          "value": ""
        }
      ]
    }
  ]
}
```

```

    }
  ],
  "id": 1
}

```

See also

- [Host](#)
- [Host group](#)
- [Time period](#)

Source

CMaintenance::get() in *ui/include/classes/api/services/CMaintenance.php*.

maintenance.update

Description

object maintenance.update(object/array maintenances)

This method allows to update existing maintenances.

Note:

This method is only available to *Admin* and *Super admin* user types. Permissions to call the method can be revoked in user role settings. See [User roles](#) for more information.

Parameters

(object/array) Maintenance properties to be updated.

The `maintenanceid` property must be defined for each maintenance, all other properties are optional. Only the passed properties will be updated, all others will remain unchanged.

Additionally to the [standard maintenance properties](#), the method accepts the following parameters.

Parameter	Type	Description
groups	object/array	<p>Host groups to replace the current groups.</p> <p>The host groups must have only the <code>groupid</code> property defined.</p> <p>Parameter behavior: - <i>required</i> if <code>hosts</code> is not set</p>
hosts	object/array	<p>Hosts to replace the current hosts.</p> <p>The hosts must have only the <code>hostid</code> property defined.</p> <p>Parameter behavior: - <i>required</i> if <code>groups</code> is not set</p>
timeperiods	object/array	<p>Maintenance time periods to replace the current periods.</p>
tags	object/array	<p>Problem tags to replace the current tags.</p> <p>Parameter behavior: - <i>supported</i> if <code>maintenance_type</code> of Maintenance object is set to "with data collection"</p>

Return values

(object) Returns an object containing the IDs of the updated maintenances under the `maintenanceids` property.

Examples

Assigning different hosts

Replace the hosts currently assigned to maintenance with two different ones.

Request:

```
{
  "jsonrpc": "2.0",
  "method": "maintenance.update",
  "params": {
    "maintenanceid": "3",
    "hosts": [
      {"hostid": "10085"},
      {"hostid": "10084"}
    ]
  },
  "id": 1
}
```

Response:

```
{
  "jsonrpc": "2.0",
  "result": {
    "maintenanceids": [
      "3"
    ]
  },
  "id": 1
}
```

See also

- [Time period](#)

Source

CMaintenance::update() in *ui/include/classes/api/services/CMaintenance.php*.

Map

This class is designed to work with maps.

Object references:

- [Map](#)
- [Map element](#)
- [Map element Host](#)
- [Map element Host group](#)
- [Map element Map](#)
- [Map element Trigger](#)
- [Map element tag](#)
- [Map element URL](#)
- [Map link](#)
- [Map link trigger](#)
- [Map URL](#)
- [Map user](#)
- [Map user group](#)
- [Map shapes](#)
- [Map lines](#)

Available methods:

- [map.create](#) - create new maps
- [map.delete](#) - delete maps
- [map.get](#) - retrieve maps
- [map.update](#) - update maps

Map object

The following objects are directly related to the map API.

Map

The map object has the following properties.

Property	Type	Description
sysmapid	ID	ID of the map. Property behavior: - <i>read-only</i>
height	integer	- <i>required</i> for update operations Height of the map in pixels. Property behavior: - <i>required</i> for create operations
name	string	Name of the map. Property behavior: - <i>required</i> for create operations
width	integer	Width of the map in pixels. Property behavior: - <i>required</i> for create operations
backgroundid	ID	ID of the image used as the background for the map.
expand_macros	integer	Whether to expand macros in labels when configuring the map. Possible values: 0 - (<i>default</i>) do not expand macros; 1 - expand macros.
expandproblem	integer	Whether the problem trigger will be displayed for elements with a single problem. Possible values: 0 - always display the number of problems; 1 - (<i>default</i>) display the problem trigger if there's only one problem.
grid_align	integer	Whether to enable grid aligning. Possible values: 0 - disable grid aligning; 1 - (<i>default</i>) enable grid aligning.
grid_show	integer	Whether to show the grid on the map. Possible values: 0 - do not show the grid; 1 - (<i>default</i>) show the grid.
grid_size	integer	Size of the map grid in pixels. Supported values: 20, 40, 50, 75 and 100.
highlight	integer	Default: 50. Whether icon highlighting is enabled. Possible values: 0 - highlighting disabled; 1 - (<i>default</i>) highlighting enabled.
iconmapid	ID	ID of the icon map used on the map.
label_format	integer	Whether to enable advanced labels. Possible values: 0 - (<i>default</i>) disable advanced labels; 1 - enable advanced labels.

Property	Type	Description
label_location	integer	Location of the map element label. Possible values: 0 - (<i>default</i>) bottom; 1 - left; 2 - right; 3 - top.
label_string_host	string	Custom label for host elements. Property behavior: - <i>required</i> if label_type_host is set to "custom"
label_string_hostgroup	string	Custom label for host group elements. Property behavior: - <i>required</i> if label_type_hostgroup is set to "custom"
label_string_image	string	Custom label for image elements. Property behavior: - <i>required</i> if label_type_image is set to "custom"
label_string_map	string	Custom label for map elements. Property behavior: - <i>required</i> if label_type_map is set to "custom"
label_string_trigger	string	Custom label for trigger elements. Property behavior: - <i>required</i> if label_type_trigger is set to "custom"
label_type	integer	Map element label type. Possible values: 0 - label; 1 - IP address; 2 - (<i>default</i>) element name; 3 - status only; 4 - nothing.
label_type_host	integer	Label type for host elements. Possible values: 0 - label; 1 - IP address; 2 - (<i>default</i>) element name; 3 - status only; 4 - nothing; 5 - custom.
label_type_hostgroup	integer	Label type for host group elements. Possible values: 0 - label; 2 - (<i>default</i>) element name; 3 - status only; 4 - nothing; 5 - custom.
label_type_image	integer	Label type for host group elements. Possible values: 0 - label; 2 - (<i>default</i>) element name; 4 - nothing; 5 - custom.

Property	Type	Description
label_type_map	integer	Label type for map elements. Possible values: 0 - label; 2 - (<i>default</i>) element name; 3 - status only; 4 - nothing; 5 - custom.
label_type_trigger	integer	Label type for trigger elements. Possible values: 0 - label; 2 - (<i>default</i>) element name; 3 - status only; 4 - nothing; 5 - custom.
markelements	integer	Whether to highlight map elements that have recently changed their status. Possible values: 0 - (<i>default</i>) do not highlight elements; 1 - highlight elements.
severity_min	integer	Minimum severity of the triggers that will be displayed on the map. Refer to the trigger severity property for a list of supported trigger severities.
show_unack	integer	How problems should be displayed. Possible values: 0 - (<i>default</i>) display the count of all problems; 1 - display only the count of unacknowledged problems; 2 - display the count of acknowledged and unacknowledged problems separately.
userid	ID	ID of the user that is the owner of the map.
private	integer	Type of map sharing. Possible values: 0 - public map; 1 - (<i>default</i>) private map.
show_suppressed	integer	Whether suppressed problems are shown. Possible values: 0 - (<i>default</i>) hide suppressed problems; 1 - show suppressed problems.

Map element

The map element object defines an object displayed on a map. It has the following properties.

Property	Type	Description
selementid	ID	ID of the map element.
elements	array	Element data object. Property behavior: - <i>read-only</i> Property behavior: - <i>required</i> if elementtype is set to "host", "map", "trigger" or "host group"

Property	Type	Description
elementtype	integer	Type of map element. Possible values: 0 - host; 1 - map; 2 - trigger; 3 - host group; 4 - image. Property behavior: - <i>required</i>
iconid_off	ID	ID of the image used to display the element in default state. Property behavior: - <i>required</i>
areatype	integer	How separate host group hosts should be displayed. Possible values: 0 - (<i>default</i>) the host group element will take up the whole map; 1 - the host group element will have a fixed size.
elementsubtype	integer	How a host group element should be displayed on a map. Possible values: 0 - (<i>default</i>) display the host group as a single element; 1 - display each host in the group separately.
evaltype	integer	Map element tag filtering condition evaluation method. Possible values: 0 - (<i>default</i>) AND / OR; 2 - OR.
height	integer	Height of the fixed size host group element in pixels. Default: 200.
iconid_disabled	ID	ID of the image used to display disabled map elements. Property behavior: - <i>supported</i> if elementtype is set to "host", "map", "trigger", or "host group"
iconid_maintenance	ID	ID of the image used to display map elements in maintenance. Property behavior: - <i>supported</i> if elementtype is set to "host", "map", "trigger", or "host group"
iconid_on	ID	ID of the image used to display map elements with problems. Property behavior: - <i>supported</i> if elementtype is set to "host", "map", "trigger", or "host group"
label	string	Label of the element.
label_location	integer	Location of the map element label. Possible values: -1 - (<i>default</i>) default location; 0 - bottom; 1 - left; 2 - right; 3 - top.

Property	Type	Description
permission	integer	Type of permission level. Possible values: -1 - none; 2 - read only; 3 - read-write.
sysmapid	ID	ID of the map that the element belongs to.
urls	array	Property behavior: - <i>read-only</i> Map element URLs.
use_iconmap	integer	The map element URL object is described in detail below . Whether icon mapping must be used for host elements. Possible values: 0 - do not use icon mapping; 1 - (<i>default</i>) use icon mapping.
viewtype	integer	Host group element placing algorithm. Possible values: 0 - (<i>default</i>) grid.
width	integer	Width of the fixed size host group element in pixels. Default: 200.
x	integer	X-coordinates of the element in pixels.
y	integer	Y-coordinates of the element in pixels. Default: 0.

Map element Host

The map element Host object defines one host element.

Property	Type	Description
hostid	ID	ID of the host.

Map element Host group

The map element Host group object defines one host group element.

Property	Type	Description
groupid	ID	ID of the host group.

Map element Map

The map element Map object defines one map element.

Property	Type	Description
sysmapid	ID	ID of the map.

Map element Trigger

The map element Trigger object defines one or more trigger elements.

Property	Type	Description
triggerid	ID	ID of the trigger.

Map element tag

The map element tag object has the following properties.

Property	Type	Description
tag	string	Map element tag name.
operator	integer	<p>Property behavior: - <i>required</i></p> <p>Map element tag condition operator.</p> <p>Possible values: 0 - (<i>default</i>) Contains; 1 - Equals; 2 - Does not contain; 3 - Does not equal; 4 - Exists; 5 - Does not exist.</p>
value	string	Map element tag value.

Map element URL

The map element URL object defines a clickable link that will be available for a specific map element. It has the following properties:

Property	Type	Description
sysmapelementurlid	ID	ID of the map element URL.
name	string	<p>Property behavior: - <i>read-only</i></p> <p>Link caption.</p>
url	string	<p>Property behavior: - <i>required</i></p> <p>Link URL.</p>
selementid	ID	<p>Property behavior: - <i>required</i></p> <p>ID of the map element that the URL belongs to.</p>

Map link

The map link object defines a link between two map elements. It has the following properties.

Property	Type	Description
linkid	ID	ID of the map link.
selementid1	ID	<p>Property behavior: - <i>read-only</i></p> <p>ID of the first map element linked on one end.</p>
selementid2	ID	<p>Property behavior: - <i>required</i></p> <p>ID of the first map element linked on the other end.</p> <p>Property behavior: - <i>required</i></p>

Property	Type	Description
color	string	Line color as a hexadecimal color code.
drawtype	integer	Default: 000000. Link line draw style. Possible values: 0 - <i>(default)</i> line; 2 - bold line; 3 - dotted line; 4 - dashed line.
label	string	Link label.
linktriggers	array	Map link triggers to use as link status indicators.
permission	integer	The map link trigger object is described in detail below . Type of permission level. Possible values: -1 - none; 2 - read only; 3 - read-write.
sysmapid	ID	ID of the map the link belongs to.

Map link trigger

The map link trigger object defines a map link status indicator based on the state of a trigger. It has the following properties:

Property	Type	Description
linktriggerid	ID	ID of the map link trigger.
triggerid	ID	Property behavior: - <i>read-only</i> ID of the trigger used as a link indicator.
color	string	Property behavior: - <i>required</i> Indicator color as a hexadecimal color code.
drawtype	integer	Default: DD0000. Indicator draw style. Possible values: 0 - <i>(default)</i> line; 2 - bold line; 3 - dotted line; 4 - dashed line.
linkid	ID	ID of the map link that the link trigger belongs to.

Map URL

The map URL object defines a clickable link that will be available for all elements of a specific type on the map. It has the following properties:

Property	Type	Description
sysmapurlid	ID	ID of the map URL. Property behavior: - <i>read-only</i>

Property	Type	Description
name	string	Link caption.
url	string	Property behavior: - <i>required</i> Link URL.
elementtype	integer	Property behavior: - <i>required</i> Type of map element for which the URL will be available. Refer to the map element type property for a list of supported types.
sysmapid	ID	Default: 0. ID of the map that the URL belongs to.

Map user

List of map permissions based on users. It has the following properties:

Property	Type	Description
sysmapuserid	ID	ID of the map user.
userid	ID	Property behavior: - <i>read-only</i> ID of the user.
permission	integer	Property behavior: - <i>required</i> Type of permission level. Possible values: 2 - read only; 3 - read-write. Property behavior: - <i>required</i>

Map user group

List of map permissions based on user groups. It has the following properties:

Property	Type	Description
sysmapusrgrpid	ID	ID of the map user group.
usrgrpid	ID	Property behavior: - <i>read-only</i> ID of the user group.
permission	integer	Property behavior: - <i>required</i> Type of permission level. Possible values: 2 - read only; 3 - read-write. Property behavior: - <i>required</i>

Map shapes

The map shape object defines a geometric shape (with or without text) displayed on a map. It has the following properties:

Property	Type	Description
sysmap_shapeid	ID	ID of the map shape element.
type	integer	<p>Property behavior: - <i>read-only</i></p> <p>Type of map shape element.</p> <p>Possible values: 0 - rectangle; 1 - ellipse.</p> <p>Property is required when new shapes are created.</p>
x	integer	<p>Property behavior: - <i>required</i></p> <p>X-coordinates of the shape in pixels.</p>
y	integer	<p>Default: 0.</p> <p>Y-coordinates of the shape in pixels.</p>
width	integer	<p>Default: 0.</p> <p>Width of the shape in pixels.</p>
height	integer	<p>Default: 200.</p> <p>Height of the shape in pixels.</p>
text	string	<p>Default: 200.</p> <p>Text of the shape.</p>
font	integer	<p>Font of the text within shape.</p> <p>Possible values: 0 - Georgia, serif 1 - "Palatino Linotype", "Book Antiqua", Palatino, serif 2 - "Times New Roman", Times, serif 3 - Arial, Helvetica, sans-serif 4 - "Arial Black", Gadget, sans-serif 5 - "Comic Sans MS", cursive, sans-serif 6 - Impact, Charcoal, sans-serif 7 - "Lucida Sans Unicode", "Lucida Grande", sans-serif 8 - Tahoma, Geneva, sans-serif 9 - "Trebuchet MS", Helvetica, sans-serif 10 - Verdana, Geneva, sans-serif 11 - "Courier New", Courier, monospace 12 - "Lucida Console", Monaco, monospace</p>
font_size	integer	<p>Default: 9.</p> <p>Font size in pixels.</p>
font_color	string	<p>Default: 11.</p> <p>Font color.</p> <p>Default: 000000.</p>

Property	Type	Description
text_halign	integer	Horizontal alignment of text. Possible values: 0 - center; 1 - left; 2 - right.
text_valign	integer	Default: 0. Vertical alignment of text. Possible values: 0 - middle; 1 - top; 2 - bottom.
border_type	integer	Default: 0. Type of the border. Possible values: 0 - none; 1 - _____; 2 - - - -; 3 - - - - -.
border_width	integer	Default: 0. Width of the border in pixels.
border_color	string	Default: 0. Border color.
background_color	string	Default: 000000. Background color (fill color).
zindex	integer	Default: (empty). Value used to order all shapes and lines (z-index). Default: 0.

Map lines

The map line object defines a line displayed on a map. It has the following properties:

Property	Type	Description
sysmap_shapeid	ID	ID of the map shape element.
x1	integer	Property behavior: - <i>read-only</i> X-coordinates of the line point 1 in pixels.
y1	integer	Default: 0. Y-coordinates of the line point 1 in pixels.
x2	integer	Default: 0. X-coordinates of the line point 2 in pixels.
y2	integer	Default: 200. Y-coordinates of the line point 2 in pixels. Default: 200.

Property	Type	Description
line_type	integer	Type of the lines. Possible values: 0 - none; 1 - _____; 2 - ---; 3 - - - -.
line_width	integer	Default: 0. Width of the lines in pixels.
line_color	string	Default: 0. Line color.
zindex	integer	Default: 000000. Value used to order all shapes and lines (z-index). Default: 0.

map.create

Description

object `map.create(object/array maps)`

This method allows to create new maps.

Note:

This method is available to users of any type. Permissions to call the method can be revoked in user role settings. See [User roles](#) for more information.

Parameters

(object/array) Maps to create.

Additionally to the [standard map properties](#), the method accepts the following parameters.

Parameter	Type	Description
links	array	Map links to be created on the map.
selements	array	Map elements to be created on the map.
urls	array	Map URLs to be created on the map.
users	array	Map user shares to be created on the map.
userGroups	array	Map user group shares to be created on the map.
shapes	array	Map shapes to be created on the map.
lines	array	Map lines to be created on the map.

Note:

To create map links you'll need to set a map element `selementid` to an arbitrary value and then use this value to reference this element in the links `selementid1` or `selementid2` properties. When the element is created, this value will be replaced with the correct ID generated by Zabbix. See [example](#).

Return values

(object) Returns an object containing the IDs of the created maps under the `sysmapids` property. The order of the returned IDs matches the order of the passed maps.

Examples

Create an empty map

Create a map with no elements.

Request:

```
{
  "jsonrpc": "2.0",
  "method": "map.create",
  "params": {
    "name": "Map",
    "width": 600,
    "height": 600
  },
  "id": 1
}
```

Response:

```
{
  "jsonrpc": "2.0",
  "result": {
    "sysmapids": [
      "8"
    ]
  },
  "id": 1
}
```

Create a host map

Create a map with two host elements and a link between them. Note the use of temporary "selementid1" and "selementid2" values in the map link object to refer to map elements.

Request:

```
{
  "jsonrpc": "2.0",
  "method": "map.create",
  "params": {
    "name": "Host map",
    "width": 600,
    "height": 600,
    "selements": [
      {
        "selementid": "1",
        "elements": [
          {"hostid": "1033"}
        ],
        "elementtype": 0,
        "iconid_off": "2"
      },
      {
        "selementid": "2",
        "elements": [
          {"hostid": "1037"}
        ],
        "elementtype": 0,
        "iconid_off": "2"
      }
    ],
    "links": [
      {
        "selementid1": "1",
        "selementid2": "2"
      }
    ]
  },
  "id": 1
}
```

Response:

```
{
  "jsonrpc": "2.0",
  "result": {
    "sysmapids": [
      "9"
    ]
  },
  "id": 1
}
```

Create a trigger map

Create a map with trigger element, which contains two triggers.

Request:

```
{
  "jsonrpc": "2.0",
  "method": "map.create",
  "params": {
    "name": "Trigger map",
    "width": 600,
    "height": 600,
    "selements": [
      {
        "elements": [
          {"triggerid": "12345"},
          {"triggerid": "67890"}
        ],
        "elementtype": 2,
        "iconid_off": "2"
      }
    ]
  },
  "id": 1
}
```

Response:

```
{
  "jsonrpc": "2.0",
  "result": {
    "sysmapids": [
      "10"
    ]
  },
  "id": 1
}
```

Map sharing

Create a map with two types of sharing (user and user group).

Request:

```
{
  "jsonrpc": "2.0",
  "method": "map.create",
  "params": {
    "name": "Map sharing",
    "width": 600,
    "height": 600,
    "users": [
      {
        "userid": "4",
        "permission": "3"
      }
    ]
  }
}
```

```

    }
  ],
  "userGroups": [
    {
      "usrgrpId": "7",
      "permission": "2"
    }
  ]
},
"id": 1
}

```

Response:

```

{
  "jsonrpc": "2.0",
  "result": {
    "sysmapids": [
      "9"
    ]
  },
  "id": 1
}

```

Map shapes

Create a map with map name title.

Request:

```

{
  "jsonrpc": "2.0",
  "method": "map.create",
  "params": {
    "name": "Host map",
    "width": 600,
    "height": 600,
    "shapes": [
      {
        "type": 0,
        "x": 0,
        "y": 0,
        "width": 600,
        "height": 11,
        "text": "{MAP.NAME}"
      }
    ]
  },
  "id": 1
}

```

Response:

```

{
  "jsonrpc": "2.0",
  "result": {
    "sysmapids": [
      "10"
    ]
  },
  "id": 1
}

```

Map lines

Create a map line.

Request:

```
{
  "jsonrpc": "2.0",
  "method": "map.create",
  "params": {
    "name": "Map API lines",
    "width": 500,
    "height": 500,
    "lines": [
      {
        "x1": 30,
        "y1": 10,
        "x2": 100,
        "y2": 50,
        "line_type": 1,
        "line_width": 10,
        "line_color": "009900"
      }
    ]
  },
  "id": 1
}
```

Response:

```
{
  "jsonrpc": "2.0",
  "result": {
    "sysmapids": [
      "11"
    ]
  },
  "id": 1
}
```

See also

- [Map element](#)
- [Map link](#)
- [Map URL](#)
- [Map user](#)
- [Map user group](#)
- [Map shape](#)
- [Map line](#)

Source

CMap::create() in *ui/include/classes/api/services/CMap.php*.

map.delete

Description

object map.delete(array mapIds)

This method allows to delete maps.

Note:

This method is available to users of any type. Permissions to call the method can be revoked in user role settings. See [User roles](#) for more information.

Parameters

(array) IDs of the maps to delete.

Return values

(object) Returns an object containing the IDs of the deleted maps under the `sysmapids` property.

Examples

Delete multiple maps

Delete two maps.

Request:

```
{
  "jsonrpc": "2.0",
  "method": "map.delete",
  "params": [
    "12",
    "34"
  ],
  "id": 1
}
```

Response:

```
{
  "jsonrpc": "2.0",
  "result": {
    "sysmapids": [
      "12",
      "34"
    ]
  },
  "id": 1
}
```

Source

CMap::delete() in `ui/include/classes/api/services/CMap.php`.

map.get

Description

integer/array map.get(object parameters)

The method allows to retrieve maps according to the given parameters.

Note:

This method is available to users of any type. Permissions to call the method can be revoked in user role settings. See [User roles](#) for more information.

Parameters

(object) Parameters defining the desired output.

The method supports the following parameters.

Parameter	Type	Description
<code>sysmapids</code>	ID/array	Returns only maps with the given IDs.
<code>userid</code>	ID/array	Returns only maps that belong to the given user IDs.
<code>expandUrls</code>	flag	Adds global map URLs to the corresponding map elements and expands macros in all map element URLs.
<code>selectIconMap</code>	query	Returns an <code>iconmap</code> property with the icon map used on the map.
<code>selectLinks</code>	query	Returns a <code>links</code> property with the map links between elements.
<code>selectSelements</code>	query	Returns a <code>selements</code> property with the map elements.
<code>selectUrls</code>	query	Returns a <code>urls</code> property with the map URLs.
<code>selectUsers</code>	query	Returns a <code>users</code> property with users that the map is shared with.
<code>selectUserGroups</code>	query	Returns a <code>userGroups</code> property with user groups that the map is shared with.
<code>selectShapes</code>	query	Returns a <code>shapes</code> property with the map shapes.

Parameter	Type	Description
selectLines	query	Returns a <code>lines</code> property with the map lines.
sortfield	string/array	Sort the result by the given properties.
countOutput	boolean	Possible values: <code>name</code> , <code>width</code> , <code>height</code> . These parameters being common for all <code>get</code> methods are described in detail in the reference commentary .
editable	boolean	
excludeSearch	boolean	
filter	object	
limit	integer	
output	query	
preservekeys	boolean	
search	object	
searchByAny	boolean	
searchWildcardsEnabled	boolean	
sortorder	string/array	
startSearch	boolean	

Return values

(integer/array) Returns either:

- an array of objects;
- the count of retrieved objects, if the `countOutput` parameter has been used.

Examples

Retrieve a map

Retrieve all data about map "3".

Request:

```
{
  "jsonrpc": "2.0",
  "method": "map.get",
  "params": {
    "output": "extend",
    "selectSelements": "extend",
    "selectLinks": "extend",
    "selectUsers": "extend",
    "selectUserGroups": "extend",
    "selectShapes": "extend",
    "selectLines": "extend",
    "sysmapids": "3"
  },
  "id": 1
}
```

Response:

```
{
  "jsonrpc": "2.0",
  "result": [
    {
      "selements": [
        {
          "selementid": "10",
          "sysmapid": "3",
          "elementtype": "4",
          "evaltype": "0",
          "iconid_off": "1",
          "iconid_on": "0",
          "label": "Zabbix server",
          "label_location": "3",

```

```

        "x": "11",
        "y": "141",
        "iconid_disabled": "0",
        "iconid_maintenance": "0",
        "elementsubtype": "0",
        "areatype": "0",
        "width": "200",
        "height": "200",
        "tags": [
            {
                "tag": "service",
                "value": "mysqld",
                "operator": "0"
            }
        ],
        "viewtype": "0",
        "use_iconmap": "1",
        "urls": [],
        "elements": []
    },
    {
        "selementid": "11",
        "sysmapid": "3",
        "elementtype": "4",
        "evaltype": "0",
        "iconid_off": "1",
        "iconid_on": "0",
        "label": "Web server",
        "label_location": "3",
        "x": "211",
        "y": "191",
        "iconid_disabled": "0",
        "iconid_maintenance": "0",
        "elementsubtype": "0",
        "areatype": "0",
        "width": "200",
        "height": "200",
        "viewtype": "0",
        "use_iconmap": "1",
        "tags": [],
        "urls": [],
        "elements": []
    },
    {
        "selementid": "12",
        "sysmapid": "3",
        "elementtype": "0",
        "evaltype": "0",
        "iconid_off": "185",
        "iconid_on": "0",
        "label": "{HOST.NAME}\r\n{HOST.CONN}",
        "label_location": "0",
        "x": "111",
        "y": "61",
        "iconid_disabled": "0",
        "iconid_maintenance": "0",
        "elementsubtype": "0",
        "areatype": "0",
        "width": "200",
        "height": "200",
        "viewtype": "0",
        "use_iconmap": "0",
    }

```



```

        "tags": [],
        "urls": [],
        "elements": [
            {
                "hostid": "10084"
            }
        ]
    },
    "links": [
        {
            "linkid": "23",
            "sysmapid": "3",
            "selementid1": "10",
            "selementid2": "11",
            "drawtype": "0",
            "color": "00CC00",
            "label": "",
            "linktriggers": []
        }
    ],
    "users": [
        {
            "sysmapuserid": "1",
            "userid": "2",
            "permission": "2"
        }
    ],
    "userGroups": [
        {
            "sysmapusrgrpid": "1",
            "usrgrpid": "7",
            "permission": "2"
        }
    ],
    "shapes": [
        {
            "sysmap_shapeid": "1",
            "type": "0",
            "x": "0",
            "y": "0",
            "width": "680",
            "height": "15",
            "text": "{MAP.NAME}",
            "font": "9",
            "font_size": "11",
            "font_color": "000000",
            "text_halign": "0",
            "text_valign": "0",
            "border_type": "0",
            "border_width": "0",
            "border_color": "000000",
            "background_color": "",
            "zindex": "0"
        }
    ],
    "lines": [
        {
            "sysmap_shapeid": "2",
            "x1": 30,
            "y1": 10,
            "x2": 100,

```

```

        "y2": 50,
        "line_type": 1,
        "line_width": 10,
        "line_color": "009900",
        "zindex": "1"
    }
],
"sysmapid": "3",
"name": "Local network",
"width": "400",
"height": "400",
"backgroundid": "0",
"label_type": "2",
"label_location": "3",
"highlight": "1",
"expandproblem": "1",
"markelements": "0",
"show_unack": "0",
"grid_size": "50",
"grid_show": "1",
"grid_align": "1",
"label_format": "0",
"label_type_host": "2",
"label_type_hostgroup": "2",
"label_type_trigger": "2",
"label_type_map": "2",
"label_type_image": "2",
"label_string_host": "",
"label_string_hostgroup": "",
"label_string_trigger": "",
"label_string_map": "",
"label_string_image": "",
"iconmapid": "0",
"expand_macros": "0",
"severity_min": "0",
"userid": "1",
"private": "1",
"show_suppressed": "1"
}
],
"id": 1
}

```

See also

- [Icon map](#)
- [Map element](#)
- [Map link](#)
- [Map URL](#)
- [Map user](#)
- [Map user group](#)
- [Map shapes](#)
- [Map lines](#)

Source

CMap::get() in *ui/include/classes/api/services/CMap.php*.

map.update

Description

object map.update(object/array maps)

This method allows to update existing maps.

Note:

This method is available to users of any type. Permissions to call the method can be revoked in user role settings. See [User roles](#) for more information.

Parameters

(object/array) Map properties to be updated.

The `mapid` property must be defined for each map, all other properties are optional. Only the passed properties will be updated, all others will remain unchanged.

Additionally to the [standard map properties](#), the method accepts the following parameters.

Parameter	Type	Description
links	array	Map links to replace the existing links.
selements	array	Map elements to replace the existing elements.
urls	array	Map URLs to replace the existing URLs.
users	array	Map user shares to replace the existing elements.
userGroups	array	Map user group shares to replace the existing elements.
shapes	array	Map shapes to replace the existing shapes.
lines	array	Map lines to replace the existing lines.

Note:

To create map links between new map elements you'll need to set an element's `selementid` to an arbitrary value and then use this value to reference this element in the links `selementid1` or `selementid2` properties. When the element is created, this value will be replaced with the correct ID generated by Zabbix. See [example for map.create](#).

Return values

(object) Returns an object containing the IDs of the updated maps under the `sysmapids` property.

Examples**Resize a map**

Change the size of the map to 1200x1200 pixels.

Request:

```
{
  "jsonrpc": "2.0",
  "method": "map.update",
  "params": {
    "sysmapid": "8",
    "width": 1200,
    "height": 1200
  },
  "id": 1
}
```

Response:

```
{
  "jsonrpc": "2.0",
  "result": {
    "sysmapids": [
      "8"
    ]
  },
  "id": 1
}
```

Change map owner

Available only for admins and super admins.

Request:

```
{
  "jsonrpc": "2.0",
  "method": "map.update",
  "params": {
    "sysmapid": "9",
    "userid": "1"
  },
  "id": 1
}
```

Response:

```
{
  "jsonrpc": "2.0",
  "result": {
    "sysmapids": [
      "9"
    ]
  },
  "id": 1
}
```

See also

- [Map element](#)
- [Map link](#)
- [Map URL](#)
- [Map user](#)
- [Map user group](#)
- [Map shapes](#)
- [Map lines](#)

Source

CMap::update() in *ui/include/classes/api/services/CMap.php*.

Media type

This class is designed to work with media types.

Object references:

- [Media type](#)
- [Webhook parameters](#)
- [Script parameters](#)
- [Message template](#)

Available methods:

- [mediatype.create](#) - create new media types
- [mediatype.delete](#) - delete media types
- [mediatype.get](#) - retrieve media types
- [mediatype.update](#) - update media types

Media type object

The following objects are directly related to the mediatype API.

Media type

The media type object has the following properties.

Property	Type	Description
mediatypeid	ID	ID of the media type.
		Property behavior: - <i>read-only</i>
name	string	- <i>required</i> for update operations Name of the media type.
		Property behavior: - <i>required</i> for create operations
type	integer	Transport used by the media type.
		Possible values: 0 - Email; 1 - Script; 2 - SMS; 4 - Webhook.
		Property behavior: - <i>required</i> for create operations
exec_path	string	For script media types <code>exec_path</code> contains the name of the executed script.
		Property behavior: - <i>required</i> if <code>type</code> is set to "Script"
gsm_modem	string	Serial device name of the GSM modem.
		Property behavior: - <i>required</i> if <code>type</code> is set to "SMS"
passwd	string	Authentication password.
		Property behavior: - <i>supported</i> if <code>type</code> is set to "Email"
smtp_email	string	Email address from which notifications will be sent.
		Property behavior: - <i>required</i> if <code>type</code> is set to "Email"
smtp_helo	string	SMTP HELO.
		Property behavior: - <i>required</i> if <code>type</code> is set to "Email"
smtp_server	string	SMTP server.
		Property behavior: - <i>required</i> if <code>type</code> is set to "Email"
smtp_port	integer	SMTP server port to connect to.
smtp_security	integer	SMTP connection security level to use.
		Possible values: 0 - None; 1 - STARTTLS; 2 - SSL/TLS.
smtp_verify_host	integer	SSL verify host for SMTP.
		Possible values: 0 - No; 1 - Yes.
smtp_verify_peer	integer	SSL verify peer for SMTP.
		Possible values: 0 - No; 1 - Yes.

Property	Type	Description
smtp_authentication	integer	SMTP authentication method to use. Possible values: 0 - None; 1 - Normal password.
status	integer	Whether the media type is enabled. Possible values: 0 - (default) Enabled; 1 - Disabled.
username	string	User name.
maxsessions	integer	Property behavior: - <i>supported</i> if type is set to "Email" The maximum number of alerts that can be processed in parallel. Possible values if type is set to "SMS": (default) 1. Possible values if type is set to "Email", "Script", or "Webhook": 0-100.
maxattempts	integer	The maximum number of attempts to send an alert. Possible values: 1-100.
attempt_interval	string	Default value: 3. The interval between retry attempts. Accepts seconds and time unit with suffix. Possible values: 0-1h.
message_format	integer	Default value: 10s. Message format. Possible values: 0 - plain text; 1 - (default) html.
script	text	Media type webhook script javascript body.
timeout	string	Media type webhook script timeout. Accepts seconds and time unit with suffix. Possible values: 1-60s.
process_tags	integer	Default: 30s. Defines should the webhook script response to be interpreted as tags and these tags should be added to associated event. Possible values: 0 - (default) Ignore webhook script response; 1 - Process webhook script response as tags.
show_event_menu	integer	Show media type entry in <code>problem.get</code> and <code>event.get</code> property <code>urls</code> . Possible values: 0 - (default) Do not add <code>urls</code> entry; 1 - Add media type to <code>urls</code> property.
event_menu_url	string	Define <code>url</code> property of media type entry in <code>urls</code> property of <code>problem.get</code> and <code>event.get</code> .
event_menu_name	string	Define <code>name</code> property of media type entry in <code>urls</code> property of <code>problem.get</code> and <code>event.get</code> .
parameters	array	Array of webhook or script input parameters.
description	text	Media type description.

Webhook parameters

Parameters passed to a webhook script when it is being called have the following properties.

Property	Type	Description
name	string	Parameter name.
value	string	<p>Property behavior: - <i>required</i></p> Parameter value, supports macros. Supported macros are described on the Supported macros page.

Script parameters

Parameters passed to a script when it is being called have the following properties.

Property	Type	Description
sortorder	integer	The order in which the parameters will be passed to the script as command-line arguments, starting with 0 as the first one.
value	string	<p>Property behavior: - <i>required</i></p> Parameter value, supports macros. Supported macros are described on the Supported macros page.

Message template

The message template object defines a template that will be used as a default message for action operations to send a notification. It has the following properties.

Property	Type	Description
eventsources	integer	Event source. Possible values: 0 - triggers; 1 - discovery; 2 - autoregistration; 3 - internal; 4 - services.
recovery	integer	<p>Property behavior: - <i>required</i></p> Operation mode. Possible values: 0 - operations; 1 - recovery operations; 2 - update operations.
subject	string	<p>Property behavior: - <i>required</i></p> Message subject.
message	string	Message text.

mediatype.create

Description

```
object mediatype.create(object/array mediaTypes)
```

This method allows to create new media types.

Note:

This method is only available to *Super admin* user type. Permissions to call the method can be revoked in user role settings. See [User roles](#) for more information.

Parameters

(object/array) Media types to create.

Additionally to the [standard media type properties](#), the method accepts the following parameters.

Parameter	Type	Description
parameters	array	Script or webhook parameters to be created for the media type.
message_templates	array	Message templates to be created for the media type.

Return values

(object) Returns an object containing the IDs of the created media types under the `mediatypeids` property. The order of the returned IDs matches the order of the passed media types.

Examples**Creating an email media type**

Create a new email media type with a custom SMTP port and message templates.

Request:

```
{
  "jsonrpc": "2.0",
  "method": "mediatype.create",
  "params": {
    "type": "0",
    "name": "Email",
    "smtp_server": "mail.example.com",
    "smtp_helo": "example.com",
    "smtp_email": "zabbix@example.com",
    "smtp_port": "587",
    "message_format": "1",
    "message_templates": [
      {
        "eventsourcing": "0",
        "recovery": "0",
        "subject": "Problem: {EVENT.NAME}",
        "message": "Problem \"{EVENT.NAME}\" on host \"{HOST.NAME}\" started at {EVENT.TIME}."
      },
      {
        "eventsourcing": "0",
        "recovery": "1",
        "subject": "Resolved in {EVENT.DURATION}: {EVENT.NAME}",
        "message": "Problem \"{EVENT.NAME}\" on host \"{HOST.NAME}\" has been resolved at {EVENT.R}."
      },
      {
        "eventsourcing": "0",
        "recovery": "2",
        "subject": "Updated problem in {EVENT.AGE}: {EVENT.NAME}",
        "message": "{USER.FULLNAME} {EVENT.UPDATE.ACTION} problem \"{EVENT.NAME}\" on host \"{HOST"
      }
    ]
  },
  "id": 1
}
```

Response:

```
{
  "jsonrpc": "2.0",
```



```

    "result": {
      "mediatypeids": [
        "7"
      ]
    },
    "id": 1
  }
}

```

Creating a script media type

Create a new script media type with a custom value for the number of attempts and the interval between them.

Request:

```

{
  "jsonrpc": "2.0",
  "method": "mediatype.create",
  "params": {
    "type": "1",
    "name": "Push notifications",
    "exec_path": "push-notification.sh",
    "maxattempts": "5",
    "attempt_interval": "11s",
    "parameters": [
      {
        "sortorder": "0",
        "value": "{ALERT.SENDTO}"
      },
      {
        "sortorder": "1",
        "value": "{ALERT.SUBJECT}"
      },
      {
        "sortorder": "2",
        "value": "{ALERT.MESSAGE}"
      }
    ]
  },
  "id": 1
}

```

Response:

```

{
  "jsonrpc": "2.0",
  "result": {
    "mediatypeids": [
      "8"
    ]
  },
  "id": 1
}

```

Creating a webhook media type

Create a new webhook media type.

Request:

```

{
  "jsonrpc": "2.0",
  "method": "mediatype.create",
  "params": {
    "type": "4",
    "name": "Webhook",
    "script": "var Webhook = {\r\n    token: null,\r\n    to: null,\r\n    subject: null,\r\n    messa",
    "parameters": [

```

```

    {
      "name": "Message",
      "value": "{ALERT.MESSAGE}"
    },
    {
      "name": "Subject",
      "value": "{ALERT.SUBJECT}"
    },
    {
      "name": "To",
      "value": "{ALERT.SENDTO}"
    },
    {
      "name": "Token",
      "value": "<Token>"
    }
  ]
},
"id": 1
}

```

Response:

```

{
  "jsonrpc": "2.0",
  "result": {
    "mediatypeids": [
      "9"
    ]
  },
  "id": 1
}

```

Source

CMediaType::create() in *ui/include/classes/api/services/CMediaType.php*.

mediatype.delete

Description

object mediatype.delete(array mediaTypeIds)

This method allows to delete media types.

Note:

This method is only available to *Super admin* user type. Permissions to call the method can be revoked in user role settings. See [User roles](#) for more information.

Parameters

(array) IDs of the media types to delete.

Return values

(object) Returns an object containing the IDs of the deleted media types under the `mediatypeids` property.

Examples

Deleting multiple media types

Delete two media types.

Request:

```

{
  "jsonrpc": "2.0",
  "method": "mediatype.delete",

```

```

    "params": [
        "3",
        "5"
    ],
    "id": 1
}

```

Response:

```

{
    "jsonrpc": "2.0",
    "result": {
        "mediatypeids": [
            "3",
            "5"
        ]
    },
    "id": 1
}

```

Source

CMediaType::delete() in *ui/include/classes/api/services/CMediaType.php*.

mediatype.get

Description

integer/array mediatype.get(object parameters)

The method allows to retrieve media types according to the given parameters.

Note:

This method is available to users of any type. Permissions to call the method can be revoked in user role settings. See [User roles](#) for more information.

Parameters

(object) Parameters defining the desired output.

The method supports the following parameters.

Note:

When requesting user-related information of media types, *Admin* type users may retrieve only data about their own user. For an example, see [Retrieving media types as Admin](#).

Parameter	Type	Description
mediatypeids	ID/array	Return only media types with the given IDs.
mediaids	ID/array	Return only media types used by the given media .
userid	ID/array	Return only media types used by the given users.
selectActions	query	Return an actions property with the actions that use the media type.
selectMessageTemplates	query	Return a message_templates property with an array of media type messages.
selectUsers	query	Return a users property with the users that use the media type.
sortfield	string/array	Sort the result by the given properties.

Parameter behavior:

- *supported* for *Super admin* type users

Possible values: mediatypeid.

Parameter	Type	Description
filter	object	Return only those results that exactly match the given filter. Accepts an object, where the keys are property names, and the values are either a single value or an array of values to match against. Supported properties for <i>Super admin</i> type users: all Media type object properties, except properties of text data type . Supported properties for <i>Admin</i> and <i>User</i> type users: mediatypeid , name , type , status , maxattempts . Media type object properties to be returned.
output	query	Media type object properties to be returned. <i>Admin</i> and <i>User</i> type users may retrieve only the following Media type object properties: mediatypeid , name , type , status , maxattempts , description . For an example, see Retrieving media types as Admin .
search	object	Default: extend . Return results that match the given pattern (case-insensitive). Accepts an object, where the keys are property names, and the values are strings to search for. If no additional options are given, this will perform a LIKE "%...%" search. Supported properties for <i>Super admin</i> type users: all Media type object properties of string and text data type . Supported properties for <i>Admin</i> and <i>User</i> type users: name , description .
countOutput	boolean	These parameters being common for all get methods are described in detail in the reference commentary .
editable	boolean	
excludeSearch	boolean	
limit	integer	
preservekeys	boolean	
searchByAny	boolean	
searchWildcardsEnabled	boolean	
sortorder	string/array	
startSearch	boolean	

Return values

(integer/array) Returns either:

- an array of objects;
- the count of retrieved objects, if the `countOutput` parameter has been used.

Examples

Retrieving media types

Retrieve all configured media types. The following example returns two media types:

- email media type;
- SMS media type.

Request:

```
{
  "jsonrpc": "2.0",
  "method": "mediatype.get",
  "params": {
    "output": "extend",
    "selectMessageTemplates": "extend"
  }
}
```

```
},
  "id": 1
}
```

Response:

```
{
  "jsonrpc": "2.0",
  "result": [
    {
      "mediatypeid": "1",
      "type": "0",
      "name": "Email",
      "smtp_server": "mail.example.com",
      "smtp_helo": "example.com",
      "smtp_email": "zabbix@example.com",
      "exec_path": "",
      "gsm_modem": "",
      "username": "",
      "passwd": "",
      "status": "0",
      "smtp_port": "25",
      "smtp_security": "0",
      "smtp_verify_peer": "0",
      "smtp_verify_host": "0",
      "smtp_authentication": "0",
      "maxsessions": "1",
      "maxattempts": "3",
      "attempt_interval": "10s",
      "message_format": "0",
      "script": "",
      "timeout": "30s",
      "process_tags": "0",
      "show_event_menu": "1",
      "event_menu_url": "",
      "event_menu_name": "",
      "description": "",
      "message_templates": [
        {
          "eventsourc": "0",
          "recovery": "0",
          "subject": "Problem: {EVENT.NAME}",
          "message": "Problem started at {EVENT.TIME} on {EVENT.DATE}\r\nProblem name: {EVENT.NA",
        },
        {
          "eventsourc": "0",
          "recovery": "1",
          "subject": "Resolved: {EVENT.NAME}",
          "message": "Problem has been resolved at {EVENT.RECOVERY.TIME} on {EVENT.RECOVERY.DATE",
        },
        {
          "eventsourc": "0",
          "recovery": "2",
          "subject": "Updated problem: {EVENT.NAME}",
          "message": "{USER.FULLNAME} {EVENT.UPDATE.ACTION} problem at {EVENT.UPDATE.DATE} {EVEN",
        },
        {
          "eventsourc": "1",
          "recovery": "0",
          "subject": "Discovery: {DISCOVERY.DEVICE.STATUS} {DISCOVERY.DEVICE.IPADDRESS}",
          "message": "Discovery rule: {DISCOVERY.RULE.NAME}\r\n\r\nDevice IP: {DISCOVERY.DEVICE.",
        },
        {

```

```

        "eventsourc": "2",
        "recovery": "0",
        "subject": "Autoregistration: {HOST.HOST}",
        "message": "Host name: {HOST.HOST}\r\nHost IP: {HOST.IP}\r\nAgent port: {HOST.PORT}"
    }
],
"parameters": []
},
{
    "mediatypeid": "3",
    "type": "2",
    "name": "SMS",
    "smtp_server": "",
    "smtp_helo": "",
    "smtp_email": "",
    "exec_path": "",
    "gsm_modem": "/dev/ttyS0",
    "username": "",
    "passwd": "",
    "status": "0",
    "smtp_port": "25",
    "smtp_security": "0",
    "smtp_verify_peer": "0",
    "smtp_verify_host": "0",
    "smtp_authentication": "0",
    "maxsessions": "1",
    "maxattempts": "3",
    "attempt_interval": "10s",
    "message_format": "1",
    "script": "",
    "timeout": "30s",
    "process_tags": "0",
    "show_event_menu": "1",
    "event_menu_url": "",
    "event_menu_name": "",
    "description": "",
    "message_templates": [
        {
            "eventsourc": "0",
            "recovery": "0",
            "subject": "",
            "message": "{EVENT.SEVERITY}: {EVENT.NAME}\r\nHost: {HOST.NAME}\r\n{EVENT.DATE} {EVENT.TIME}"
        },
        {
            "eventsourc": "0",
            "recovery": "1",
            "subject": "",
            "message": "RESOLVED: {EVENT.NAME}\r\nHost: {HOST.NAME}\r\n{EVENT.DATE} {EVENT.TIME}"
        },
        {
            "eventsourc": "0",
            "recovery": "2",
            "subject": "",
            "message": "{USER.FULLNAME} {EVENT.UPDATE.ACTION} problem at {EVENT.UPDATE.DATE} {EVENT.UPDATE.TIME}"
        },
        {
            "eventsourc": "1",
            "recovery": "0",
            "subject": "",
            "message": "Discovery: {DISCOVERY.DEVICE.STATUS} {DISCOVERY.DEVICE.IPADDRESS}"
        },
        {

```

```

        "eventsourcesource": "2",
        "recovery": "0",
        "subject": "",
        "message": "Autoregistration: {HOST.HOST}\r\nHost IP: {HOST.IP}\r\nAgent port: {HOST.P
    }
  ],
  "parameters": []
}
],
"id": 1
}

```

Retrieving media types as *Admin*

As an *Admin* type user, retrieve all media types that are enabled, with users that use these media types. The following example returns two media types:

- email media type with one user (only *Admin* type user's own user);
- SMS media type with no users.

Request:

```

{
  "jsonrpc": "2.0",
  "method": "mediatype.get",
  "params": {
    "output": "extend",
    "filter": {
      "status": 0
    },
    "selectUsers": "extend"
  },
  "id": 1
}

```

Response:

```

{
  "jsonrpc": "2.0",
  "result": [
    {
      "mediatypeid": "1",
      "type": "0",
      "name": "Email",
      "status": "0",
      "description": "",
      "maxattempts": "3",
      "users": [
        {
          "userid": "3",
          "username": "database-admin",
          "name": "John",
          "surname": "Doe",
          "url": "",
          "autologin": "0",
          "autologout": "0",
          "lang": "default",
          "refresh": "30s",
          "theme": "default",
          "attempt_failed": "0",
          "attempt_ip": "",
          "attempt_clock": "0",
          "rows_per_page": "50",
          "timezone": "default",
          "roleid": "2",
          "userdirectoryid": "0",

```

```

        "ts_provisioned": "0"
      }
    ]
  },
  {
    "mediatypeid": "3",
    "type": "2",
    "name": "SMS",
    "status": "0",
    "description": "",
    "maxattempts": "3",
    "users": []
  }
],
"id": 1
}

```

Retrieve script and webhook media types

The following example returns three media types:

- script media type with parameters;
- script media type without parameters;
- webhook media type with parameters.

Request:

```

{
  "jsonrpc": "2.0",
  "method": "mediatype.get",
  "params": {
    "output": ["mediatypeid", "name", "parameters"],
    "filter": {
      "type": [1, 4]
    }
  },
  "id": 1
}

```

Response:

```

{
  "jsonrpc": "2.0",
  "result": [
    {
      "mediatypeid": "10",
      "name": "Script with parameters",
      "parameters": [
        {
          "sortorder": "0",
          "value": "{ALERT.SENDTO}"
        },
        {
          "sortorder": "1",
          "value": "{EVENT.NAME}"
        },
        {
          "sortorder": "2",
          "value": "{ALERT.MESSAGE}"
        },
        {
          "sortorder": "3",
          "value": "Zabbix alert"
        }
      ]
    }
  ],
}

```



```

    {
      "mediatypeid": "13",
      "name": "Script without parameters",
      "parameters": []
    },
    {
      "mediatypeid": "11",
      "name": "Webhook",
      "parameters": [
        {
          "name": "alert_message",
          "value": "{ALERT.MESSAGE}"
        },
        {
          "name": "event_update_message",
          "value": "{EVENT.UPDATE.MESSAGE}"
        },
        {
          "name": "host_name",
          "value": "{HOST.NAME}"
        },
        {
          "name": "trigger_description",
          "value": "{TRIGGER.DESRIPTION}"
        },
        {
          "name": "trigger_id",
          "value": "{TRIGGER.ID}"
        },
        {
          "name": "alert_source",
          "value": "Zabbix"
        }
      ]
    }
  ],
  "id": 1
}

```

See also

- [User](#)

Source

CMediaType::get() in `ui/include/classes/api/services/CMediaType.php`.

mediatype.update

Description

object mediatype.update(object/array mediaTypes)

This method allows to update existing media types.

Note:

This method is only available to *Super admin* user type. Permissions to call the method can be revoked in user role settings. See [User roles](#) for more information.

Parameters

(object/array) Media type properties to be updated.

The `mediatypeid` property must be defined for each media type, all other properties are optional. Only the passed properties will be updated, all others will remain unchanged.

Additionally to the [standard media type properties](#), the method accepts the following parameters.

Parameter	Type	Description
parameters	array	Script or webhook parameters to replace the current parameters.
message_templates	array	Message templates to replace the current message templates.

Return values

(object) Returns an object containing the IDs of the updated media types under the `mediatypeids` property.

Examples

Enabling a media type

Enable a media type, that is, set its status to "0".

Request:

```
{
  "jsonrpc": "2.0",
  "method": "mediatype.update",
  "params": {
    "mediatypeid": "6",
    "status": "0"
  },
  "id": 1
}
```

Response:

```
{
  "jsonrpc": "2.0",
  "result": {
    "mediatypeids": [
      "6"
    ]
  },
  "id": 1
}
```

Source

`CMediaType::update()` in `ui/include/classes/api/services/CMediaType.php`.

MFA

This class is designed to work with MFA (Multi-Factor Authentication) methods.

Object references:

- [MFA](#)

Available methods:

- [mfa.create](#) - create new MFA methods
- [mfa.delete](#) - delete MFA methods
- [mfa.get](#) - retrieve MFA methods
- [mfa.update](#) - update MFA methods

MFA object

The following objects are directly related to the `mfa` API.

MFA

The MFA (Multi-Factor Authentication) object has the following properties.

Property	Type	Description
mfaid	ID	ID of the MFA method.
type	integer	<p>Property behavior:</p> <ul style="list-style-type: none"> - <i>read-only</i> - <i>required</i> for update operations Type of the MFA method.
name	string	Possible values: 1 - TOTP (Time-based One-Time Passwords); 2 - Duo Universal Prompt. Unique name of the MFA method.
hash_function	integer	<p>Property behavior:</p> <ul style="list-style-type: none"> - <i>required</i> for create operations Type of the hash function for generating TOTP codes.
code_length	integer	Possible values: 1 - SHA-1; 2 - SHA-256; 3 - SHA-512.
api_hostname	string	<p>Property behavior:</p> <ul style="list-style-type: none"> - <i>required</i> if <code>type</code> is set to "TOTP" Verification code length.
clientid	string	Possible values: 6 - 6-digit long; 8 - 8-digit long.
client_secret	string	<p>Property behavior:</p> <ul style="list-style-type: none"> - <i>required</i> if <code>type</code> is set to "TOTP" API hostname provided by the Duo authentication service.
		<p>Property behavior:</p> <ul style="list-style-type: none"> - <i>required</i> if <code>type</code> is set to "Duo Universal Prompt" Client ID provided by the Duo authentication service.
		<p>Property behavior:</p> <ul style="list-style-type: none"> - <i>required</i> if <code>type</code> is set to "Duo Universal Prompt" Client secret provided by the Duo authentication service.
		<p>Property behavior:</p> <ul style="list-style-type: none"> - <i>write-only</i> - <i>required</i> if <code>type</code> is set to "Duo Universal Prompt"

mfa.create

Description

object `mfa.create(object/array MFA methods)`

This method allows to create new MFA methods.

Note:

This method is only available to *Super admin* user type. Permissions to call the method can be revoked in user role settings. See [User roles](#) for more information.

Parameters

(object/array) MFA methods to create.

The method accepts MFA methods with the [standard MFA method properties](#).

Return values

(object) Returns an object containing the IDs of the created MFA methods under the `mfaids` property. The order of the returned IDs matches the order of the passed items.

Examples

Creating MFA methods

Create a "Zabbix TOTP" MFA method utilizing time-based one-time passwords (TOTP), with the hash function for generating TOTP codes set to SHA-1 and the verification code length set to 6 digits.

Request:

```
{
  "jsonrpc": "2.0",
  "method": "mfa.create",
  "params": {
    "type": 1,
    "name": "Zabbix TOTP",
    "hash_function": 1,
    "code_length": 6
  },
  "id": 1
}
```

Response:

```
{
  "jsonrpc": "2.0",
  "result": {
    "mfaids": [
      "1"
    ]
  },
  "id": 1
}
```

Source

`CMfa::create()` in `ui/include/classes/api/services/CMfa.php`.

mfa.delete

Description

object `mfa.delete(array mfaids)`

This method allows to delete MFA methods.

Note:

This method is only available to *Super admin* user type. Permissions to call the method can be revoked in user role settings. See [User roles](#) for more information.

Parameters

(array) IDs of the MFA methods to delete.

Return values

(object) Returns an object containing the IDs of the deleted MFA methods under the `mfaids` property.

Examples

Deleting MFA methods

Delete an MFA method.

Request:

```
{
  "jsonrpc": "2.0",
  "method": "mfa.delete",
  "params": [
    "2"
  ],
  "id": 1
}
```

Response:

```
{
  "jsonrpc": "2.0",
  "result": {
    "mfaids": [
      "2"
    ]
  },
  "id": 1
}
```

Source

CMfa::delete() in *ui/include/classes/api/services/CMfa.php*.

mfa.get

Description

integer/array mfa.get(object parameters)

The method allows to retrieve MFA methods according to the given parameters.

Note:

This method is only available to *Super admin* user type. Permissions to call the method can be revoked in user role settings. See [User roles](#) for more information.

Parameters

(object) Parameters defining the desired output.

The method supports the following parameters.

Parameter	Type	Description
mfaids	ID/array	Return only MFA methods with the given IDs.
selectUsrgrps	query	Return a <code>usrgrps</code> property with user groups associated with MFA methods.
filter	object	Supports <code>count</code> . Return only those results that exactly match the given filter. Accepts an object, where the keys are property names, and the values are either a single value or an array of values to match against.
sortfield	string/array	Supports properties: <code>mfaid</code> - ID of the MFA method; <code>type</code> - Type of the MFA method. Sort the result by the given properties. Possible values: <code>name</code> .

Parameter	Type	Description
search	object	Return results that match the given pattern (case-insensitive). Accepts an object, where the keys are property names, and the values are strings to search for. If no additional options are given, this will perform a LIKE "%...%" search.
countOutput	boolean	Supported properties: name. These parameters being common for all get methods are described in detail in the reference commentary page.
excludeSearch	boolean	
limit	integer	
output	query	
preservekeys	boolean	
searchByAny	boolean	
searchWildcardsEnabled	boolean	
sortorder	string/array	
startSearch	boolean	

Return values

(integer/array) Returns either:

- an array of objects;
- the count of retrieved objects, if the countOutput parameter has been used.

Examples

Finding MFA methods by name

Retrieve all MFA methods with "Zabbix" in their name.

Request:

```
{
  "jsonrpc": "2.0",
  "method": "mfa.get",
  "params": {
    "output": "extend",
    "search": {
      "name": "Zabbix"
    }
  },
  "id": 1
}
```

Response:

```
{
  "jsonrpc": "2.0",
  "result": [
    {
      "mfaid": "1",
      "type": "1",
      "name": "Zabbix TOTP 1",
      "hash_function": "1",
      "code_length": "6",
      "api_hostname": "",
      "clientid": ""
    },
    {
      "mfaid": "2",
      "type": "1",
      "name": "Zabbix TOTP 2",
      "hash_function": "3",
      "code_length": "8",

```

```
        "api_hostname": "",
        "clientid": ""
    }
],
"id": 1
}
```

Source

CMfa::get() in `ui/include/classes/api/services/CMfa.php`.

mfa.update

Description

object mfa.update(object/array MFA methods)

This method allows to update existing MFA methods.

Note:

This method is only available to *Super admin* user type. Permissions to call the method can be revoked in user role settings. See [User roles](#) for more information.

Parameters

(object/array) MFA method properties to be updated.

The `mfaid` property must be defined for each item, all other properties are optional. Only the passed properties will be updated, all others will remain unchanged.

The method accepts MFA methods with the [standard MFA method properties](#).

Return values

(object) Returns an object containing the IDs of the updated MFA methods under the `mfaids` property.

Examples

Updating method properties

Update the hash function for generating TOTP codes and the verification code length for the "Zabbix TOTP" MFA method utilizing time-based one-time passwords (TOTP).

Request:

```
{
  "jsonrpc": "2.0",
  "method": "mfa.update",
  "params": {
    "mfaid": "1",
    "hash_function": 3,
    "code_length": 8
  },
  "id": 1
}
```

Response:

```
{
  "jsonrpc": "2.0",
  "result": {
    "mfaids": [
      "1"
    ]
  },
  "id": 1
}
```

Source

CMfa::update() in *ui/include/classes/api/services/CMfa.php*.

Module

This class is designed to work with frontend modules.

Object references:

- [Module](#)

Available methods:

- [module.create](#) - install new modules
- [module.delete](#) - uninstall modules
- [module.get](#) - retrieve modules
- [module.update](#) - update modules

Module object

The following objects are directly related to the module API.

Module

The module object has the following properties.

Property	Type	Description
moduleid	ID	ID of the module as stored in the database.
id	string	<p>Property behavior:</p> <ul style="list-style-type: none">- <i>read-only</i>- <i>required</i> for update operations <p>Unique module ID as defined by a developer in the manifest.json file of the module.</p> <p>Possible values for built-in modules: see property "type" description in Dashboard widget.</p>
relative_path	string	<p>Property behavior:</p> <ul style="list-style-type: none">- <i>required</i> for create operations <p>Path to the directory of the module relative to the directory of the Zabbix frontend.</p> <p>Possible values: widgets/* - for built-in widget modules; modules/* - for third-party modules.</p>
status	integer	<p>Property behavior:</p> <ul style="list-style-type: none">- <i>required</i> for create operations <p>Whether the module is enabled or disabled.</p> <p>Possible values: 0 - (<i>default</i>) Disabled; 1 - Enabled.</p>
config	object	Module configuration.

module.create

Description

object `module.create(object/array modules)`

This method allows to install new frontend modules.

Note:

This method is only available to *Super admin* user type. Permissions to call the method can be revoked in user role settings. See [User roles](#) for more information.

Attention:

Module files must be unpacked manually in the correct subdirectories, matching the `relative_path` property of the modules.

Parameters

(object/array) Modules to create.

The method accepts modules with the **standard module properties**.

Return values

(object) Returns an object containing the IDs of the installed modules under the `moduleids` property. The order of the returned IDs matches the order of the passed modules.

Examples**Installing a module**

Install a module with the status "Enabled".

Request:

```
{
  "jsonrpc": "2.0",
  "method": "module.create",
  "params": {
    "id": "example_module",
    "relative_path": "modules/example_module",
    "status": 1
  },
  "id": 1
}
```

Response:

```
{
  "jsonrpc": "2.0",
  "result": {
    "moduleids": [
      "25"
    ]
  },
  "id": 1
}
```

See also

- [Module](#)
- [Frontend modules](#)

Source

CModule::create() in `ui/include/classes/api/services/CModule.php`.

module.delete**Description**

object `module.delete(array moduleids)`

This method allows to uninstall modules.

Note:

This method is only available to *Super admin* user type. Permissions to call the method can be revoked in user role settings. See [User roles](#) for more information.

Attention:

Module files must be removed manually.

Parameters

(array) IDs of the modules to uninstall.

Return values

(object) Returns an object containing the IDs of the uninstalled modules under the `moduleids` property.

Examples

Uninstalling multiple modules

Uninstall modules "27" and "28".

Request:

```
{
  "jsonrpc": "2.0",
  "method": "module.delete",
  "params": [
    "27",
    "28"
  ],
  "id": 1
}
```

Response:

```
{
  "jsonrpc": "2.0",
  "result": {
    "moduleids": [
      "27",
      "28"
    ]
  },
  "id": 1
}
```

Source

`CModule::delete()` in `ui/include/classes/api/services/CModule.php`.

module.get

Description

`integer/array module.get(object parameters)`

The method allows to retrieve modules according to the given parameters.

Note:

This method is available to users of any type. Permissions to call the method can be revoked in user role settings. See [User roles](#) for more information.

Parameters

(object) Parameters defining the desired output.

The method supports the following parameters.

Parameter	Type	Description
<code>moduleids</code>	ID/array	Return only modules with the given IDs.
<code>sortfield</code>	string/array	Sort the result by the given properties.
<code>countOutput</code>	boolean	Possible values: <code>moduleid</code> , <code>relative_path</code> . These parameters being common for all <code>get</code> methods are described in detail in the Reference commentary page.
<code>excludeSearch</code>	boolean	

Parameter	Type	Description
filter	object	
limit	integer	
output	query	
preservekeys	boolean	
search	object	
searchByAny	boolean	
searchWildcardsEnabled	boolean	
sortorder	string/array	
startSearch	boolean	

Return values

(integer/array) Returns either:

- an array of objects;
- the count of retrieved objects, if the `countOutput` parameter has been used.

Examples

Retrieving a module by ID

Retrieve all data about modules "1", "2", and "25".

Request:

```
{
  "jsonrpc": "2.0",
  "method": "module.get",
  "params": {
    "output": "extend",
    "moduleids": [
      "1",
      "2",
      "25"
    ]
  },
  "id": 1
}
```

Response:

```
{
  "jsonrpc": "2.0",
  "result": [
    {
      "moduleid": "1",
      "id": "actionlog",
      "relative_path": "widgets/actionlog",
      "status": "1",
      "config": []
    },
    {
      "moduleid": "2",
      "id": "clock",
      "relative_path": "widgets/clock",
      "status": "1",
      "config": []
    },
    {
      "moduleid": "25",
      "id": "example",
      "relative_path": "modules/example_module",
      "status": "1",
      "config": []
    }
  ]
}
```

```
    ],  
    "id": 1  
}
```

See also

- [Module](#)
- [Dashboard widget](#)
- [Frontend modules](#)

Source

CModule::get() in `ui/include/classes/api/services/CModule.php`.

module.update

Description

object module.update(object/array modules)

This method allows to update existing modules.

Note:

This method is only available to *Super admin* user type. Permissions to call the method can be revoked in user role settings. See [User roles](#) for more information.

Parameters

(object/array) Module properties to be updated.

The `moduleid` property must be defined for each module, all other properties are optional. Only the specified properties will be updated.

The method accepts modules with the [standard module properties](#).

Return values

(object) Returns an object containing the IDs of the updated modules under the `moduleids` property.

Examples

Disabling a module

Disable module "25".

Request:

```
{  
  "jsonrpc": "2.0",  
  "method": "module.update",  
  "params": {  
    "moduleid": "25",  
    "status": 0  
  },  
  "id": 1  
}
```

Response:

```
{  
  "jsonrpc": "2.0",  
  "result": {  
    "moduleids": [  
      "25"  
    ]  
  },  
  "id": 1  
}
```

See also

- [Module](#)
- [Frontend modules](#)

Source

CModule::update() in *ui/include/classes/api/services/CModule.php*.

Problem

This class is designed to work with problems.

Object references:

- [Problem](#)
- [Problem tag](#)
- [Media type URL](#)

Available methods:

- [problem.get](#) - retrieve problems

Problem object

The following objects are directly related to the problem API.

Problem

Note:

Problems are created by the Zabbix server and cannot be modified via the API.

The problem object has the following properties.

Property	Type	Description
eventid	ID	ID of the problem event.
source	integer	Type of the problem event. Possible values: 0 - event created by a trigger; 3 - internal event; 4 - event created on service status update.
object	integer	Type of object that is related to the problem event. Possible values if source is set to "event created by a trigger": 0 - trigger. Possible values if source is set to "internal event": 0 - trigger; 4 - item; 5 - LLD rule. Possible values if source is set to "event created on service status update": 6 - service.
objectid	ID	ID of the related object.
clock	timestamp	Time when the problem event was created.
ns	integer	Nanoseconds when the problem event was created.
r_eventid	ID	ID of the recovery event.
r_clock	timestamp	Time when the recovery event was created.
r_ns	integer	Nanoseconds when the recovery event was created.
cause_eventid	ID	ID of the cause event.
correlationid	ID	ID of the correlation rule if this event was recovered by a global correlation rule.
userid	ID	ID of the user that closed the problem (if the problem was closed manually).

Property	Type	Description
name	string	Resolved problem name.
acknowledged	integer	Acknowledge state for problem. Possible values: 0 - not acknowledged; 1 - acknowledged.
severity	integer	Problem current severity. Possible values: 0 - not classified; 1 - information; 2 - warning; 3 - average; 4 - high; 5 - disaster.
suppressed	integer	Whether the problem is suppressed. Possible values: 0 - problem is in normal state; 1 - problem is suppressed.
opdata	string	Operational data with expanded macros.
urls	array	Active media type URLs.

Problem tag

The problem tag object has the following properties.

Property	Type	Description
tag	string	Problem tag name.
value	string	Problem tag value.

Media type URL

The media type URL object has the following properties.

Property	Type	Description
name	string	Media type defined URL name.
url	string	Media type defined URL value.

Results will contain entries only for active media types with enabled event menu entry. Macro used in properties will be expanded, but if one of the properties contains an unexpanded macro, both properties will be excluded from results. For supported macros, see *Supported macros*.

problem.get

Description

`integer/array problem.get(object parameters)`

The method allows to retrieve problems according to the given parameters.

This method is for retrieving unresolved problems. It is also possible, if specified, to additionally retrieve recently resolved problems. The period that determines how old is "recently" is defined in *Administration* → *General*. Problems that were resolved prior to that period are not kept in the problem table. To retrieve problems that were resolved further back in the past, use the `event.get` method.

Attention:

This method may return problems of a deleted entity if these problems have not been removed by the housekeeper yet.

Note:

This method is available to users of any type. Permissions to call the method can be revoked in user role settings. See [User roles](#) for more information.

Parameters

(object) Parameters defining the desired output.

The method supports the following parameters.

Parameter	Type	Description
eventids	ID/array	Return only problems with the given IDs.
groupids	ID/array	Return only problems created by objects that belong to the given host groups.
hostids	ID/array	Return only problems created by objects that belong to the given hosts.
objectids	ID/array	Return only problems created by the given objects.
source	integer	Return only problems with the given type. Refer to the problem event object page for a list of supported event types.
object	integer	Default: 0 - problem created by a trigger. Return only problems created by objects of the given type. Refer to the problem event object page for a list of supported object types.
acknowledged	boolean	Default: 0 - trigger. <code>true</code> - return acknowledged problems only; <code>false</code> - unacknowledged only.
action	integer	Return only problems for which the given event update actions have been performed. For multiple actions, use a sum of any acceptable bitmap values as bitmask (for example, 34 for acknowledge and suppress event).
action_userids	ID/array	Return only problems with the given IDs of users who performed the problem event update actions.
suppressed	boolean	<code>true</code> - return only suppressed problems; <code>false</code> - return problems in the normal state.
symptom	boolean	<code>true</code> - return only symptom problem events; <code>false</code> - return only cause problem events.
severities	integer/array	Return only problems with given event severities. Applies only if object is trigger.
evaltype	integer	Rules for tag searching.
tags	array	Possible values: 0 - (default) And/Or; 2 - Or. Return only problems with given tags. Exact match by tag and case-insensitive search by value and operator. Format: [{"tag": "<tag>", "value": "<value>", "operator": "<operator>"}, ...]. An empty array returns all problems.
recent	boolean	Possible operator types: 0 - (default) Like; 1 - Equal; 2 - Not like; 3 - Not equal 4 - Exists; 5 - Not exists. <code>true</code> - return PROBLEM and recently RESOLVED problems (depends on Display OK triggers for N seconds) Default: <code>false</code> - UNRESOLVED problems only

Parameter	Type	Description
eventid_from	string	Return only problems with IDs greater or equal to the given ID.
eventid_till	string	Return only problems with IDs less or equal to the given ID.
time_from	timestamp	Return only problems that have been created after or at the given time.
time_till	timestamp	Return only problems that have been created before or at the given time.
selectAcknowledges	query	Return an <code>acknowledges</code> property with the problem updates. Problem updates are sorted in reverse chronological order. The problem update object has the following properties: <code>acknowledgeid</code> - (ID) ID of the update; <code>userid</code> - (ID) ID of the user that updated the event; <code>eventid</code> - (ID) ID of the updated event; <code>clock</code> - (timestamp) time when the event was updated; <code>message</code> - (string) text of the message; <code>action</code> - (integer) type of update action (see <code>event.acknowledge</code>); <code>old_severity</code> - (integer) event severity before this update action; <code>new_severity</code> - (integer) event severity after this update action; <code>suppress_until</code> - (timestamp) time till event will be suppressed; <code>taskid</code> - (ID) ID of the task if the current event is undergoing a rank change.
selectTags	query	Supports <code>count</code> . Return a <code>tags</code> property with the problem tags. Output format: <code>[{"tag": "<tag>", "value": "<value>"}, ...]</code> .
selectSuppressionData	query	Return a <code>suppression_data</code> property with the list of active maintenances and manual suppressions: <code>maintenanceid</code> - (ID) ID of the maintenance; <code>userid</code> - (ID) ID of user who suppressed the problem; <code>suppress_until</code> - (integer) time until the problem is suppressed.
filter	object	Return only those results that exactly match the given filter. Accepts an object, where the keys are property names, and the values are either a single value or an array of values to match against.
sortfield	string/array	Does not support properties of text <code>data type</code> . Sort the result by the given properties.
countOutput	boolean	Possible values: <code>eventid</code> . These parameters being common for all <code>get</code> methods are described in detail in the <code>reference commentary</code> page.
editable	boolean	
excludeSearch	boolean	
limit	integer	
output	query	
preservekeys	boolean	
search	object	
searchByAny	boolean	
searchWildcardsEnabled	boolean	
sortorder	string/array	
startSearch	boolean	

Return values

(integer/array) Returns either:

- an array of objects;
- the count of retrieved objects, if the `countOutput` parameter has been used.

Examples

Retrieving trigger problem events

Retrieve recent events from trigger "15112."

Request:

```
{
  "jsonrpc": "2.0",
  "method": "problem.get",
  "params": {
    "output": "extend",
    "selectAcknowledges": "extend",
    "selectTags": "extend",
    "selectSuppressionData": "extend",
    "objectids": "15112",
    "recent": "true",
    "sortfield": ["eventid"],
    "sortorder": "DESC"
  },
  "id": 1
}
```

Response:

```
{
  "jsonrpc": "2.0",
  "result": [
    {
      "eventid": "1245463",
      "source": "0",
      "object": "0",
      "objectid": "15112",
      "clock": "1472457242",
      "ns": "209442442",
      "r_eventid": "1245468",
      "r_clock": "1472457285",
      "r_ns": "125644870",
      "correlationid": "0",
      "userid": "1",
      "name": "Zabbix agent on localhost is unreachable for 5 minutes",
      "acknowledged": "1",
      "severity": "3",
      "cause_eventid": "0",
      "opdata": "",
      "acknowledges": [
        {
          "acknowledgeid": "14443",
          "userid": "1",
          "eventid": "1245463",
          "clock": "1472457281",
          "message": "problem solved",
          "action": "6",
          "old_severity": "0",
          "new_severity": "0",
          "suppress_until": "1472511600",
          "taskid": "0"
        }
      ],
      "suppression_data": [
        {
          "maintenanceid": "15",
          "suppress_until": "1472511600",
          "userid": "0"
        }
      ],
      "suppressed": "1",
      "tags": [

```

```

        {
            "tag": "test-tag",
            "value": "test-value"
        }
    ],
    "id": 1
}

```

Retrieving problems acknowledged by specified user

Retrieving problems acknowledged by user with ID=10

Request:

```

{
  "jsonrpc": "2.0",
  "method": "problem.get",
  "params": {
    "output": "extend",
    "action": 2,
    "action_userids": [10],
    "selectAcknowledges": ["userid", "action"],
    "sortfield": ["eventid"],
    "sortorder": "DESC"
  },
  "id": 1
}

```

Response:

```

{
  "jsonrpc": "2.0",
  "result": [
    {
      "eventid": "1248566",
      "source": "0",
      "object": "0",
      "objectid": "15142",
      "clock": "1472457242",
      "ns": "209442442",
      "r_eventid": "1245468",
      "r_clock": "1472457285",
      "r_ns": "125644870",
      "correlationid": "0",
      "userid": "10",
      "name": "Zabbix agent on localhost is unreachable for 5 minutes",
      "acknowledged": "1",
      "severity": "3",
      "cause_eventid": "0",
      "opdata": "",
      "acknowledges": [
        {
          "userid": "10",
          "action": "2"
        }
      ],
      "suppressed": "0"
    }
  ],
  "id": 1
}

```

See also

- Alert
- Item
- Host
- LLD rule
- Trigger

Source

CEvent::get() in *ui/include/classes/api/services/CProblem.php*.

Proxy

This class is designed to work with proxies.

Object references:

- Proxy

Available methods:

- **proxy.create** - create new proxies
- **proxy.delete** - delete proxies
- **proxy.get** - retrieve proxies
- **proxy.update** - update proxies

Proxy object

The following objects are directly related to the proxy API.

Proxy

The proxy object has the following properties.

Property	Type	Description
proxyid	ID	ID of the proxy.
		Property behavior: - <i>read-only</i>
name	string	- <i>required</i> for update operations Name of the proxy.
		Property behavior: - <i>required</i> for create operations
proxy_groupid	ID	ID of the proxy group.
local_address	string	0 - proxy is not assigned to any proxy group. Address for active agents. IP address or DNS name to connect to.
local_port	string	- <i>required</i> if proxy_groupid is not 0 Local proxy port number to connect to.
		User macros are supported.
		Default: 10051.
		Property behavior: - <i>supported</i> if proxy_groupid is not 0

Property	Type	Description
operating_mode	integer	Type of proxy. Possible values: 0 - active proxy; 1 - passive proxy. Property behavior: - <i>required</i> for create operations
description	text	Description of the proxy.
lastaccess	timestamp	Time when the proxy last connected to the server. Property behavior: - <i>read-only</i>
address	string	IP address or DNS name to connect to. User macros are supported. Property behavior: - <i>required</i> if the Zabbix proxy operating mode is passive
port	string	Port number to connect to. User macros are supported. Default: 10051. Property behavior: - <i>supported</i> if the Zabbix proxy operating mode is passive
allowed_addresses	string	Comma-delimited IP addresses or DNS names of active Zabbix proxy.
tls_connect	integer	Connections to host. Possible values: 1 - (<i>default</i>) No encryption; 2 - PSK; 4 - certificate.
tls_accept	integer	Connections from host. Possible bitmap values: 1 - (<i>default</i>) No encryption; 2 - PSK; 4 - certificate. This is a bitmask field; any sum of possible bitmap values is acceptable (for example, 6 for PSK and certificate).
tls_issuer	string	Certificate issuer.
tls_subject	string	Certificate subject.
tls_psk_identity	string	PSK identity; must be paired with only one PSK (across autoregistration , hosts , and proxies). Do not include sensitive information in the PSK identity, as it is sent unencrypted over the network to inform the receiver which PSK to use. Property behavior: - <i>write-only</i> - <i>required</i> if <code>tls_connect</code> is set to "PSK", or <code>tls_accept</code> contains the "PSK" bit
tls_psk	string	Pre-shared key (PSK); must be at least 32 hex digits. Property behavior: - <i>write-only</i> - <i>required</i> if <code>tls_connect</code> is set to "PSK", or <code>tls_accept</code> contains the "PSK" bit

Property	Type	Description
custom_timeouts	integer	Whether to override global item timeouts on the proxy level.
timeout_zabbix_agent	string	<p>Possible values: 0 - (<i>default</i>) use global settings; 1 - override timeouts. Spend no more than <code>timeout_*</code> seconds on processing. Accepts seconds or time unit with suffix (e.g., 30s, 1m). Also accepts user macros.</p> <p>Possible values range: 1-600s.</p> <p>Default: "".</p> <p>Property behavior: - <i>required</i> if <code>custom_timeouts</code> is set to 1.</p>
timeout_simple_check timeout_snmp_agent timeout_external_check timeout_db_monitor timeout_http_agent timeout_ssh_agent timeout_telnet_agent timeout_script timeout_browser		
version	integer	<p>Version of proxy.</p> <p>Three-part Zabbix version number, where two decimal digits are used for each part, e.g., 60401 for version 6.4.1, 70002 for version 7.0.2, etc. 0 - Unknown proxy version.</p> <p>Property behavior: - <i>read-only</i></p>
compatibility	integer	<p>Version of proxy compared to Zabbix server version.</p> <p>Possible values: 0 - Undefined; 1 - Current version (proxy and server have the same major version); 2 - Outdated version (proxy version is older than server version, but is partially supported); 3 - Unsupported version (proxy version is older than server previous LTS release version or server major version is older than proxy major version).</p> <p>Property behavior: - <i>read-only</i></p>
state	integer	<p>State of the proxy.</p> <p>Possible values: 0 - Unknown; 1 - Offline; 2 - Online.</p> <p>Property behavior: - <i>read-only</i></p>

proxy.create

Description

object proxy.create(object/array proxies)

This method allows to create new proxies.

Note:

This method is only available to *Super admin* user type. Permissions to call the method can be revoked in user role settings. See [User roles](#) for more information.

Parameters

(object/array) Proxies to create.

Additionally to the [standard proxy properties](#), the method accepts the following parameters.

Parameter	Type	Description
hosts	array	Hosts to be monitored by the proxy. If a host is already monitored by a different proxy, it will be reassigned to the current proxy. The hosts must have only the <code>hostid</code> property defined.

Return values

(object) Returns an object containing the IDs of the created proxies under the `proxyids` property. The order of the returned IDs matches the order of the passed proxies.

Examples

Create an active proxy

Create an action proxy "Active proxy" and assign a host to be monitored by it.

Request:

```
{
  "jsonrpc": "2.0",
  "method": "proxy.create",
  "params": {
    "name": "Active proxy",
    "operating_mode": "0",
    "hosts": [
      {
        "hostid": "10279"
      }
    ]
  },
  "id": 1
}
```

Response:

```
{
  "jsonrpc": "2.0",
  "result": {
    "proxyids": [
      "10280"
    ]
  },
  "id": 1
}
```

Create a passive proxy

Create a passive proxy "Passive proxy" and assign two hosts to be monitored by it.

Request:

```
{
  "jsonrpc": "2.0",
  "method": "proxy.create",
```

```

    "params": {
      "name": "Passive proxy",
      "operating_mode": "1",
      "address": "127.0.0.1",
      "port": "10051",
      "hosts": [
        {
          "hostid": "10192"
        },
        {
          "hostid": "10139"
        }
      ]
    },
    "id": 1
  }
}

```

Response:

```

{
  "jsonrpc": "2.0",
  "result": {
    "proxyids": [
      "10284"
    ]
  },
  "id": 1
}

```

Creating a proxy and adding it to a proxy group

Create an active proxy "Active proxy" and add it to proxy group with ID "1".

Request:

```

{
  "jsonrpc": "2.0",
  "method": "proxy.create",
  "params": {
    "name": "Active proxy",
    "proxy_groupid": "1",
    "operating_mode": "0"
  },
  "id": 1
}

```

Response:

```

{
  "jsonrpc": "2.0",
  "result": {
    "proxyids": [
      "5"
    ]
  },
  "id": 1
}

```

See also

- [Host](#)
- [Proxy group](#)

Source

CProxy::create() in *ui/include/classes/api/services/CProxy.php*.

proxy.delete

Description

object proxy.delete(array proxies)

This method allows to delete proxies.

Note:

This method is only available to *Super admin* user type. Permissions to call the method can be revoked in user role settings. See [User roles](#) for more information.

Parameters

(array) IDs of proxies to delete.

Return values

(object) Returns an object containing the IDs of the deleted proxies under the `proxyids` property.

Examples

Delete multiple proxies

Delete two proxies.

Request:

```
{
  "jsonrpc": "2.0",
  "method": "proxy.delete",
  "params": [
    "10286",
    "10285"
  ],
  "id": 1
}
```

Response:

```
{
  "jsonrpc": "2.0",
  "result": {
    "proxyids": [
      "10286",
      "10285"
    ]
  },
  "id": 1
}
```

Source

CProxy::delete() in `ui/include/classes/api/services/CProxy.php`.

proxy.get

Description

integer/array proxy.get(object parameters)

The method allows to retrieve proxies according to the given parameters.

Note:

This method is available to users of any type. Permissions to call the method can be revoked in user role settings. See [User roles](#) for more information.

Parameters

(object) Parameters defining the desired output.

The method supports the following parameters.

Parameter	Type	Description
proxyids	ID/array	Return only proxies with the given IDs.
selectAssignedHosts	query	Return an assignedHosts property with the hosts assigned to the proxy.
selectHosts	query	Supports count. Return a hosts property with the hosts monitored by the proxy.
selectProxyGroup	query	Supports count. Return a proxyGroup property with the proxy group object.
sortfield	string/array	Sort the result by the given properties.
countOutput	boolean	Possible values: proxyid, name, operating_mode. These parameters being common for all get methods are described in detail in the reference commentary .
editable	boolean	
excludeSearch	boolean	
filter	object	
limit	integer	
output	query	
preservekeys	boolean	
search	object	
searchByAny	boolean	
searchWildcardsEnabled	boolean	
sortorder	string/array	
startSearch	boolean	

Return values

(integer/array) Returns either:

- an array of objects;
- the count of retrieved objects, if the `countOutput` parameter has been used.

Examples

Retrieve all proxies

Retrieve all configured proxies and their interfaces.

Request:

```
{
  "jsonrpc": "2.0",
  "method": "proxy.get",
  "params": {
    "output": "extend"
  },
  "id": 1
}
```

Response:

```
{
  "jsonrpc": "2.0",
  "result": [
    {
      "proxyid": "11",
      "name": "Active proxy",
      "proxy_groupid": "0",
      "local_address": "",
      "local_port": "10051",
      "operating_mode": "0",
      "description": ""
    }
  ]
}
```

```

    "allowed_addresses": "",
    "address": "127.0.0.1",
    "port": "10051",
    "tls_connect": "1",
    "tls_accept": "1",
    "tls_issuer": "",
    "tls_subject": "",
    "custom_timeouts": "0",
    "timeout_zabbix_agent": "",
    "timeout_simple_check": "",
    "timeout_snmp_agent": "",
    "timeout_external_check": "",
    "timeout_db_monitor": "",
    "timeout_http_agent": "",
    "timeout_ssh_agent": "",
    "timeout_telnet_agent": "",
    "timeout_script": "",
    "last_access": "1693391880",
    "version": "70000",
    "compatibility": "1",
    "state": "1"
  },
  {
    "proxyid": "12",
    "name": "Passive proxy",
    "proxy_groupid": "1",
    "local_address": "127.0.0.1",
    "local_port": "10051",
    "operating_mode": "1",
    "description": "",
    "allowed_addresses": "",
    "address": "127.0.0.1",
    "port": "10051",
    "tls_connect": "1",
    "tls_accept": "1",
    "tls_issuer": "",
    "tls_subject": "",
    "custom_timeouts": "1",
    "timeout_zabbix_agent": "5s",
    "timeout_simple_check": "5s",
    "timeout_snmp_agent": "5s",
    "timeout_external_check": "5s",
    "timeout_db_monitor": "5s",
    "timeout_http_agent": "5s",
    "timeout_ssh_agent": "5s",
    "timeout_telnet_agent": "5s",
    "timeout_script": "5s",
    "lastaccess": "1693391875",
    "version": "60400",
    "compatibility": "2",
    "state": "2"
  }
],
  "id": 1
}

```

See also

- [Host](#)
- [Proxy group](#)

Source

CProxy::get() in *ui/include/classes/api/services/CProxy.php*.

proxy.update

Description

object proxy.update(object/array proxies)

This method allows to update existing proxies.

Note:

This method is only available to *Super admin* user type. Permissions to call the method can be revoked in user role settings. See [User roles](#) for more information.

Parameters

(object/array) Proxy properties to be updated.

The `proxyid` property must be defined for each proxy, all other properties are optional. Only the passed properties will be updated, all others will remain unchanged.

Additionally to the [standard proxy properties](#), the method accepts the following parameters.

Parameter	Type	Description
hosts	array	Hosts to be monitored by the proxy. If a host is already monitored by a different proxy, it will be reassigned to the current proxy. The hosts must have only the <code>hostid</code> property defined.

Return values

(object) Returns an object containing the IDs of the updated proxies under the `proxyids` property.

Examples

Change hosts monitored by a proxy

Update the proxy to monitor the two given hosts.

Request:

```
{
  "jsonrpc": "2.0",
  "method": "proxy.update",
  "params": {
    "proxyid": "10293",
    "hosts": [
      {
        "hostid": "10294"
      },
      {
        "hostid": "10295"
      }
    ]
  },
  "id": 1
}
```

Response:

```
{
  "jsonrpc": "2.0",
  "result": {
    "proxyids": [
      "10293"
    ]
  },
  "id": 1
}
```

Change proxy status

Change the proxy to an active proxy and rename it to "Active proxy".

Request:

```
{
  "jsonrpc": "2.0",
  "method": "proxy.update",
  "params": {
    "proxyid": "10293",
    "name": "Active proxy",
    "operating_mode": "0"
  },
  "id": 1
}
```

Response:

```
{
  "jsonrpc": "2.0",
  "result": {
    "proxyids": [
      "10293"
    ]
  },
  "id": 1
}
```

Add a proxy to a proxy group

Update proxy with ID "5" and add it to proxy group with ID "1".

Request:

```
{
  "jsonrpc": "2.0",
  "method": "proxy.create",
  "params": {
    "proxyid": "5",
    "proxy_groupid": "1",
    "local_address": "127.0.0.1"
  },
  "id": 1
}
```

Response:

```
{
  "jsonrpc": "2.0",
  "result": {
    "proxyids": [
      "5"
    ]
  },
  "id": 1
}
```

See also

- [Host](#)
- [Proxy group](#)

Source

CProxy::update() in *ui/include/classes/api/services/CProxy.php*.

Proxy group

This class is designed to work with proxy groups.

Object references:

- [Proxy group](#)

Available methods:

- [proxygroup.create](#) - create new proxy groups
- [proxygroup.delete](#) - delete proxy groups
- [proxygroup.get](#) - retrieve proxy groups
- [proxygroup.update](#) - update proxy groups

Proxy group object

The following objects are directly related to the `proxygroup` API.

Proxy group

The proxy group object has the following properties.

Property	Type	Description
<code>proxy_groupid</code>	ID	ID of the proxy group.
<code>name</code>	string	<p>Property behavior:</p> <ul style="list-style-type: none">- <i>read-only</i>- <i>required</i> for update operations Name of the proxy group.
<code>description</code>	text	<p>Property behavior:</p> <ul style="list-style-type: none">- <i>required</i> for create operations Description of the proxy group.
<code>failover_delay</code>	string	<p>Failover period for each proxy in the group to have online/offline state.</p> <p>Time suffixes are supported, e.g. 30s, 1m.</p> <p>User macros are supported.</p> <p>Possible values: 10s-15m.</p>
<code>min_online</code>	string	<p>Default: 1m.</p> <p>Minimum number of online proxies required for the group to be online.</p> <p>User macros are supported.</p> <p>Possible values range: 1-1000.</p>
<code>state</code>	integer	<p>Default: 1.</p> <p>State of the proxy group.</p> <p>Possible values:</p> <ul style="list-style-type: none">0 - Unknown - on server startup;1 - Offline - less that minimum number of proxies are online;2 - Recovering - transition from offline to online state;3 - Online - minimum number of online proxies are online;4 - Degrading - transition from online to offline state. <p>Property behavior:</p> <ul style="list-style-type: none">- <i>read-only</i>

`proxygroup.create`

Description

```
object proxygroup.create(object/array proxyGroups)
```

This method allows to create new proxy groups.

Note:

This method is only available to *Super admin* user type. Permissions to call the method can be revoked in user role settings. See [User roles](#) for more information.

Parameters

(object/array) Proxy groups to create.

The method accepts proxy groups with the [standard proxy group properties](#).

Return values

(object) Returns an object containing the IDs of the created proxy groups under the `proxy_groupids` property. The order of the returned IDs matches the order of the passed proxy groups.

Examples

Create a proxy group

Create a proxy group with custom settings.

Request:

```
{
  "jsonrpc": "2.0",
  "method": "proxygroup.create",
  "params": {
    "name": "Proxy group",
    "failover_delay": "5m",
    "min_online": "10"
  },
  "id": 1
}
```

Response:

```
{
  "jsonrpc": "2.0",
  "result": {
    "proxy_groupids": [
      "5"
    ]
  },
  "id": 1
}
```

Source

CProxyGroup::create() in `ui/include/classes/api/services/CProxyGroup.php`.

proxygroup.delete

Description

object proxygroup.delete(array proxyGroupIds)

This method allows to delete proxy groups.

Note:

This method is only available to *Super admin* user type. Permissions to call the method can be revoked in user role settings. See [User roles](#) for more information.

Parameters

(array) IDs of proxy groups to delete.

Return values

(object) Returns an object containing the IDs of the deleted proxy groups under the `proxy_groupids` property.

Examples

Delete multiple proxy groups

Delete two proxy groups.

Request:

```
{
  "jsonrpc": "2.0",
  "method": "proxygroup.delete",
  "params": [
    "5",
    "10"
  ],
  "id": 1
}
```

Response:

```
{
  "jsonrpc": "2.0",
  "result": {
    "proxy_groupids": [
      "5",
      "10"
    ]
  },
  "id": 1
}
```

Source

CProxyGroup::delete() in *ui/include/classes/api/services/CProxyGroup.php*.

proxygroup.get

Description

integer/array proxygroup.get(object parameters)

The method allows to retrieve proxy groups according to the given parameters.

Note:

This method is available to users of any type. Permissions to call the method can be revoked in user role settings. See [User roles](#) for more information.

Parameters

(object) Parameters defining the desired output.

The method supports the following parameters.

Parameter	Type	Description
proxy_groupids	ID/array	Return only proxy groups with the given IDs.
proxyids	ID/array	Return only proxy groups that contain the given proxies.
selectProxies	query	Return a proxies property with the proxies that belong to the proxy group.
sortfield	string/array	Supports count. Sort the result by the given properties.
countOutput	boolean	Possible values: proxy_groupid, name. These parameters being common for all get methods are described in detail in the reference commentary .
editable	boolean	
excludeSearch	boolean	

Parameter	Type	Description
filter	object	
limit	integer	
output	query	
preservekeys	boolean	
search	object	
searchByAny	boolean	
searchWildcardsEnabled	boolean	
sortorder	string/array	
startSearch	boolean	

Return values

(integer/array) Returns either:

- an array of objects;
- the count of retrieved objects, if the `countOutput` parameter has been used.

Examples

Retrieve all proxy groups

Retrieve all configured proxy groups with proxies.

Request:

```
{
  "jsonrpc": "2.0",
  "method": "proxygroup.get",
  "params": {
    "output": "extend",
    "selectProxies": ["proxyid", "name"]
  },
  "id": 1
}
```

Response:

```
{
  "jsonrpc": "2.0",
  "result": [
    {
      "proxy_groupid": "1",
      "name": "Proxy group 1",
      "failover_delay": "1m",
      "min_online": "3",
      "description": "",
      "state": "1",
      "proxies": [
        {
          "proxyid": "1",
          "name": "proxy 1"
        },
        {
          "proxyid": "2",
          "name": "proxy 2"
        }
      ]
    },
    {
      "proxy_groupid": "2",
      "name": "Proxy group 2",
      "failover_delay": "10m",
      "min_online": "3",
      "description": "",
      "state": "3",

```



```

        "proxies": [
            {
                "proxyid": "3",
                "name": "proxy 3"
            },
            {
                "proxyid": "4",
                "name": "proxy 4"
            },
            {
                "proxyid": "5",
                "name": "proxy 5"
            }
        ]
    },
    "id": 1
}

```

See also

- [Proxy](#)

Source

CProxyGroup::get() in `ui/include/classes/api/services/CProxyGroup.php`.

proxygroup.update

Description

object proxygroup.update(object/array proxyGroups)

This method allows to update existing proxy groups.

Note:

This method is only available to *Super admin* user type. Permissions to call the method can be revoked in user role settings. See [User roles](#) for more information.

Parameters

(object/array) Proxy group properties to be updated.

The `proxy_groupid` property must be defined for each proxy group, all other properties are optional. Only the passed properties will be updated, all others will remain unchanged.

The method accepts proxy groups with the [standard proxy group properties](#).

Return values

(object) Returns an object containing the IDs of the updated proxy groups under the `proxy_groupids` property.

Examples

Change minimum number of online proxies

Change minimum number of online proxies required for the group to be online.

Request:

```

{
    "jsonrpc": "2.0",
    "method": "proxygroup.update",
    "params": {
        "proxy_groupid": "5",
        "min_online": "3"
    },
    "id": 1
}

```

Response:

```
{
  "jsonrpc": "2.0",
  "result": {
    "proxy_groupids": [
      "5"
    ]
  },
  "id": 1
}
```

Source

CProxyGroup::update() in *ui/include/classes/api/services/CProxyGroup.php*.

Regular expression

This class is designed to work with global regular expressions.

Object references:

- [Regular expression](#)
- [Expressions](#)

Available methods:

- [regexp.create](#) - create new regular expressions
- [regexp.delete](#) - delete regular expressions
- [regexp.get](#) - retrieve regular expressions
- [regexp.update](#) - update regular expressions

Regular expression object

The following objects are directly related to the `regexp` API.

Regular expression

The global regular expression object has the following properties.

Property	Type	Description
regexpid	ID	ID of the regular expression.
name	string	Name of the regular expression.
test_string	string	Test string.

Expressions

The expressions object has the following properties.

Property	Type	Description
expression	string	Regular expression.

Property behavior:
- *required*

Property	Type	Description
expression_type	integer	Type of Regular expression. Possible values: 0 - Character string included; 1 - Any character string included; 2 - Character string not included; 3 - Result is TRUE; 4 - Result is FALSE.
exp_delimiter	string	Property behavior: - <i>required</i> Expression delimiter. Default value: ", ". Possible values: ", " or ". ", or "/".
case_sensitive	integer	Property behavior: - <i>supported</i> if expression_type is set to "Any character string included" Case sensitivity. Default value: 0. Possible values: 0 - Case insensitive; 1 - Case sensitive.

regexp.create

Description

object regexp.create(object/array regularExpressions)

This method allows to create new global regular expressions.

Note:

This method is only available to *Super admin* user types. Permissions to call the method can be revoked in user role settings. See [User roles](#) for more information.

Parameters

(object/array) Regular expressions to create.

Additionally to the [standard properties](#), the method accepts the following parameters.

Parameter	Type	Description
expressions	array	Expressions options. Parameter behavior: - <i>required</i>

Return values

(object) Returns an object containing the IDs of the created regular expressions under the `regexprids` property.

Examples

Creating a new global regular expression.

Request:

```
{
  "jsonrpc": "2.0",
  "method": "regex.create",
  "params": {
    "name": "Storage devices for SNMP discovery",
    "test_string": "/boot",
    "expressions": [
      {
        "expression": "^(Physical memory|Virtual memory|Memory buffers|Cached memory|Swap space)$",
        "expression_type": "4",
        "case_sensitive": "1"
      }
    ]
  },
  "id": 1
}
```

Response:

```
{
  "jsonrpc": "2.0",
  "result": {
    "regexpids": [
      "16"
    ]
  },
  "id": 1
}
```

Source

CRegex::create() in `ui/include/classes/api/services/CRegex.php`.

regex.delete

Description

object `regex.delete(array regexpids)`

This method allows to delete global regular expressions.

Note:

This method is only available to *Super admin* user types. Permissions to call the method can be revoked in user role settings. See [User roles](#) for more information.

Parameters

(array) IDs of the regular expressions to delete.

Return values

(object) Returns an object containing the IDs of the deleted regular expressions under the `regexpids` property.

Examples

Deleting multiple global regular expressions.

Request:

```
{
  "jsonrpc": "2.0",
  "method": "regex.delete",
  "params": [
    "16",
    "17"
  ],
  "id": 1
}
```

Response:

```
{
  "jsonrpc": "2.0",
  "result": {
    "regexpids": [
      "16",
      "17"
    ]
  },
  "id": 1
}
```

Source

CRegex::delete() in *ui/include/classes/api/services/CRegex.php*.

regexp.get

Description

integer/array regexp.get(object parameters)

The method allows to retrieve global regular expressions according to the given parameters.

Note:

This method is available only to *Super Admin*. Permissions to call the method can be revoked in user role settings. See [User roles](#) for more information.

Parameters

(object) Parameters defining the desired output.

The method supports the following parameters.

Parameter	Type	Description
regexpids	ID/array	Return only regular expressions with the given IDs.
selectExpressions	query	Return an expressions property.
sortfield	string/array	Sort the result by the given properties.
countOutput	boolean	Possible values: <code>regexpid</code> , <code>name</code> . These parameters being common for all get methods are described in detail in the reference commentary .
editable	boolean	
excludeSearch	boolean	
filter	object	
limit	integer	
output	query	
preservekeys	boolean	
search	object	
searchByAny	boolean	
searchWildcardsEnabled	boolean	
sortorder	string/array	
startSearch	boolean	

Return values

(integer/array) Returns either:

- an array of objects;
- the count of retrieved objects, if the `countOutput` parameter has been used.

Examples

Retrieving global regular expressions.

Request:

```

{
  "jsonrpc": "2.0",
  "method": "regexp.get",
  "params": {
    "output": ["regexpid", "name"],
    "selectExpressions": ["expression", "expression_type"],
    "regexpids": [1, 2],
    "preservekeys": true
  },
  "id": 1
}

```

Response:

```

{
  "jsonrpc": "2.0",
  "result": {
    "1": {
      "regexpid": "1",
      "name": "File systems for discovery",
      "expressions": [
        {
          "expression": "^(btrfs|ext2|ext3|ext4|reiser|xfs|ffs|ufs|jfs|jfs2|vxfs|hfs|apfs|refs|ntfs|fat32)",
          "expression_type": "3"
        }
      ]
    },
    "2": {
      "regexpid": "2",
      "name": "Network interfaces for discovery",
      "expressions": [
        {
          "expression": "^Software Loopback Interface",
          "expression_type": "4"
        },
        {
          "expression": "^(In)?[Ll]oop[Bb]ack[0-9._]*$",
          "expression_type": "4"
        },
        {
          "expression": "^NULL[0-9.*]*$",
          "expression_type": "4"
        },
        {
          "expression": "^[Ll]o[0-9.*]*$",
          "expression_type": "4"
        },
        {
          "expression": "^[Ss]ystem$",
          "expression_type": "4"
        },
        {
          "expression": "^Nu[0-9.*]*$",
          "expression_type": "4"
        }
      ]
    }
  },
  "id": 1
}

```

Source

CRegexp::get() in *ui/include/classes/api/services/CRegexp.php*.

regexp.update

Description

object regexp.update(object/array regularExpressions)

This method allows to update existing global regular expressions.

Note:

This method is only available to *Super admin* user types. Permissions to call the method can be revoked in user role settings. See [User roles](#) for more information.

Parameters

(object/array) Regular expression properties to be updated.

The `regexprid` property must be defined for each object, all other properties are optional. Only the passed properties will be updated, all others will remain unchanged.

Additionally to the [standard properties](#), the method accepts the following parameters.

Parameter	Type	Description
expressions	array	Expressions options.

Return values

(object) Returns an object containing the IDs of the updated regular expressions under the `regexprids` property.

Examples

Updating global regular expression for file systems discovery.

Request:

```
{
  "jsonrpc": "2.0",
  "method": "regexp.update",
  "params": {
    "regexprid": "1",
    "name": "File systems for discovery",
    "test_string": "",
    "expressions": [
      {
        "expression": "^(btrfs|ext2|ext3|ext4|reiser|xfs|ffs|ufs|jfs|jfs2|vxfs|hfs|apfs|refs|zfs)$",
        "expression_type": "3",
        "exp_delimiter": ",",
        "case_sensitive": "0"
      },
      {
        "expression": "^(ntfs|fat32|fat16)$",
        "expression_type": "3",
        "exp_delimiter": ",",
        "case_sensitive": "0"
      }
    ]
  },
  "id": 1
}
```

Response:

```
{
  "jsonrpc": "2.0",
  "result": {
    "regexprids": [
      "1"
    ]
  }
}
```

```

    },
    "id": 1
}

```

Source

CRegexp::update() in *ui/include/classes/api/services/CRegexp.php*.

Report

This class is designed to work with scheduled reports.

Object references:

- [Report](#)
- [Users](#)
- [User groups](#)

Available methods:

- [report.create](#) - create new scheduled reports
- [report.delete](#) - delete scheduled reports
- [report.get](#) - retrieve scheduled reports
- [report.update](#) - update scheduled reports

Report object

The following objects are directly related to the report API.

Report

The report object has the following properties:

Property	Type	Description
reportid	ID	ID of the report. Property behavior: - <i>read-only</i>
userid	ID	ID of the user who created the report. Property behavior: - <i>required</i> for update operations
name	string	Unique name of the report. Property behavior: - <i>required</i> for create operations
dashboardid	ID	ID of the dashboard that the report is based on. Property behavior: - <i>required</i> for create operations
period	integer	Period for which the report will be prepared. Possible values: 0 - (<i>default</i>) previous day; 1 - previous week; 2 - previous month; 3 - previous year.
cycle	integer	Period repeating schedule. Possible values: 0 - (<i>default</i>) daily; 1 - weekly; 2 - monthly; 3 - yearly.

Property	Type	Description
start_time	integer	Time of the day, in seconds, when the report will be prepared for sending.
weekdays	integer	<p>Default: 0. Days of the week for sending the report.</p> <p>Possible bitmap values: 1 - Monday; 2 - Tuesday; 4 - Wednesday; 8 - Thursday; 16 - Friday; 32 - Saturday; 64 - Sunday.</p> <p>This is a bitmask field; any sum of possible bitmap values is acceptable (for example, 21 for Monday, Wednesday, and Friday).</p> <p>Default: 0.</p> <p>Property behavior: - <i>required</i> if <code>cycle</code> is set to "weekly". On which date to start.</p>
active_since	string	<p>Possible values: empty string - (<i>default</i>) not specified (stored as 0); specific date in YYYY-MM-DD format (stored as a timestamp of the beginning of a day (00:00:00)).</p>
active_till	string	<p>On which date to end.</p> <p>Possible values: empty string - (<i>default</i>) not specified (stored as 0); specific date in YYYY-MM-DD format (stored as a timestamp of the end of a day (23:59:59)).</p>
subject	string	Report message subject.
message	string	Report message text.
status	integer	Whether the report is enabled or disabled.
description	text	Possible values: 0 - Disabled; 1 - (<i>default</i>) Enabled. Description of the report.
state	integer	State of the report.
lastsent	timestamp	<p>Possible values: 0 - (<i>default</i>) report was not yet processed; 1 - report was generated and successfully sent to all recipients; 2 - report generating failed; "info" contains error information; 3 - report was generated, but sending to some (or all) recipients failed; "info" contains error information.</p> <p>Property behavior: - <i>read-only</i> Unix timestamp of the last successfully sent report.</p>
info	string	<p>Property behavior: - <i>read-only</i> Error description or additional information.</p> <p>Property behavior: - <i>read-only</i></p>

Users

The users object has the following properties:

Property	Type	Description
userid	ID	ID of user to send the report to.
access_userid	ID	<p>Property behavior:</p> <p>- <i>required</i></p> ID of user on whose behalf the report will be generated.
exclude	integer	<p>0 - (<i>default</i>) Generate report by recipient.</p> Whether to exclude the user from mailing list.
		<p>Possible values:</p> 0 - (<i>default</i>) Include; 1 - Exclude.

User groups

The user groups object has the following properties:

Property	Type	Description
usrgrpuid	ID	ID of user group to send the report to.
access_userid	ID	<p>Property behavior:</p> <p>- <i>required</i></p> ID of user on whose behalf the report will be generated.
		0 - (<i>default</i>) Generate report by recipient.

report.create

Description

object report.create(object/array reports)

This method allows to create new scheduled reports.

Note:

This method is only available to *Admin* and *Super admin* user types. Permissions to call the method can be revoked in user role settings. See [User roles](#) for more information.

Parameters

(object/array) Scheduled reports to create.

Additionally to the [standard scheduled report properties](#), the method accepts the following parameters.

Parameter	Type	Description
users	object/array	<p>Users to send the report to.</p>
user_groups	object/array	<p>Parameter behavior:</p> <p>- <i>required</i> if <code>user_groups</code> is not set</p> <p>User groups to send the report to.</p>
		<p>Parameter behavior:</p> <p>- <i>required</i> if <code>users</code> is not set</p>

Return values

(object) Returns an object containing the IDs of the created scheduled reports under the `reportids` property. The order of the returned IDs matches the order of the passed scheduled reports.

Examples

Creating a scheduled report

Create a weekly report that will be prepared for the previous week every Monday-Friday at 12:00 from 2021-04-01 to 2021-08-31.

Request:

```
{
  "jsonrpc": "2.0",
  "method": "report.create",
  "params": {
    "userid": "1",
    "name": "Weekly report",
    "dashboardid": "1",
    "period": "1",
    "cycle": "1",
    "start_time": "43200",
    "weekdays": "31",
    "active_since": "2021-04-01",
    "active_till": "2021-08-31",
    "subject": "Weekly report",
    "message": "Report accompanying text",
    "status": "1",
    "description": "Report description",
    "users": [
      {
        "userid": "1",
        "access_userid": "1",
        "exclude": "0"
      },
      {
        "userid": "2",
        "access_userid": "0",
        "exclude": "1"
      }
    ],
    "user_groups": [
      {
        "usrgrpid": "7",
        "access_userid": "0"
      }
    ]
  },
  "id": 1
}
```

Response:

```
{
  "jsonrpc": "2.0",
  "result": {
    "reportids": [
      "1"
    ]
  },
  "id": 1
}
```

See also

- [Users](#)
- [User groups](#)

Source

CReport::create() in *ui/include/classes/api/services/CReport.php*.

report.delete

Description

object report.delete(array reportids)

This method allows to delete scheduled reports.

Note:

This method is only available to *Admin* and *Super admin* user type. Permissions to call the method can be revoked in user role settings. See [User roles](#) for more information.

Parameters

(array) IDs of the scheduled reports to delete.

Return values

(object) Returns an object containing the IDs of the deleted scheduled reports under the `reportids` property.

Examples

Deleting multiple scheduled reports

Delete two scheduled reports.

Request:

```
{
  "jsonrpc": "2.0",
  "method": "report.delete",
  "params": [
    "1",
    "2"
  ],
  "id": 1
}
```

Response:

```
{
  "jsonrpc": "2.0",
  "result": {
    "reportids": [
      "1",
      "2"
    ]
  },
  "id": 1
}
```

Source

CReport::delete() in *ui/include/classes/api/services/CReport.php*.

report.get

Description

integer/array report.get(object parameters)

The method allows to retrieve scheduled reports according to the given parameters.

Note:

This method is available to users of any type. Permissions to call the method can be revoked in user role settings. See [User roles](#) for more information.

Parameters

(object) Parameters defining the desired output.

The method supports the following parameters.

Parameter	Type	Description
reportids	ID/array	Return only scheduled reports with the given report IDs.
expired	boolean	If set to true returns only expired scheduled reports, if false - only active scheduled reports.
selectUsers	query	Return a users property the report is configured to be sent to.
selectUserGroups	query	Return a user_groups property the report is configured to be sent to.
sortfield	string/array	Sort the result by the given properties.
		Possible values: reportid, name, status.
countOutput	boolean	These parameters being common for all get methods are described in detail in the reference commentary page.
excludeSearch	boolean	
filter	object	
limit	integer	
output	query	
preservekeys	boolean	
search	object	
searchByAny	boolean	
searchWildcardsEnabled	boolean	
sortorder	string/array	
startSearch	boolean	

Return values

(integer/array) Returns either:

- an array of objects;
- the count of retrieved objects, if the countOutput parameter has been used.

Examples

Retrieving report data

Request:

```
{
  "jsonrpc": "2.0",
  "method": "report.get",
  "params": [
    "output": "extend",
    "selectUsers": "extend",
    "selectUserGroups": "extend",
    "reportids": ["1", "2"]
  ],
  "id": 1
}
```

Response:

```
{
  "jsonrpc": "2.0",
  "result": [
    {
      "reportid": "1",
      "userid": "1",
      "name": "Weekly report",
      "dashboardid": "1",
      "period": "1",
      "cycle": "1",
      "start_time": "43200",
    }
  ]
}
```

```

    "weekdays": "31",
    "active_since": "2021-04-01",
    "active_till": "2021-08-31",
    "subject": "Weekly report",
    "message": "Report accompanying text",
    "status": "1",
    "description": "Report description",
    "state": "1",
    "lastsent": "1613563219",
    "info": "",
    "users": [
      {
        "userid": "1",
        "access_userid": "1",
        "exclude": "0"
      },
      {
        "userid": "2",
        "access_userid": "0",
        "exclude": "1"
      }
    ],
    "user_groups": [
      {
        "usrgrpid": "7",
        "access_userid": "0"
      }
    ]
  },
  {
    "reportid": "2",
    "userid": "1",
    "name": "Monthly report",
    "dashboardid": "2",
    "period": "2",
    "cycle": "2",
    "start_time": "0",
    "weekdays": "0",
    "active_since": "2021-05-01",
    "active_till": "",
    "subject": "Monthly report",
    "message": "Report accompanying text",
    "status": "1",
    "description": "",
    "state": "0",
    "lastsent": "0",
    "info": "",
    "users": [
      {
        "userid": "1",
        "access_userid": "1",
        "exclude": "0"
      }
    ],
    "user_groups": []
  }
],
  "id": 1
}

```

See also

- [Users](#)

- [User groups](#)

Source

CReport::get() in *ui/include/classes/api/services/CReport.php*.

report.update

Description

object report.update(object/array reports)

This method allows to update existing scheduled reports.

Note:

This method is only available to *Admin* and *Super admin* user type. Permissions to call the method can be revoked in user role settings. See [User roles](#) for more information.

Parameters

(object/array) Scheduled report properties to be updated.

The `reportid` property must be defined for each scheduled report, all other properties are optional. Only the passed properties will be updated, all others will remain unchanged.

Additionally to the [standard scheduled report properties](#) the method accepts the following parameters.

Parameter	Type	Description
users	object/array	Users to replace the current users assigned to the scheduled report.
user_groups	object/array	<p>Parameter behavior:</p> <ul style="list-style-type: none"> - <i>required</i> if <code>user_groups</code> is not set <p>User groups to replace the current user groups assigned to the scheduled report.</p> <p>Parameter behavior:</p> <ul style="list-style-type: none"> - <i>required</i> if <code>users</code> is not set

Return values

(object) Returns an object containing the IDs of the updated scheduled reports under the `reportids` property.

Examples

Disabling scheduled report

Request:

```
{
  "jsonrpc": "2.0",
  "method": "report.update",
  "params": {
    "reportid": "1",
    "status": "0"
  },
  "id": 1
}
```

Response:

```
{
  "jsonrpc": "2.0",
  "result": {
    "reportids": [
      "1"
    ]
  },
}
```

```
"id": 1  
}
```

See also

- [Users](#)
- [User groups](#)

Source

`CReport::update()` in `ui/include/classes/api/services/CReport.php`.

Role

This class is designed to work with user roles.

Object references:

- [Role](#)
- [Role rules](#)
- [UI element](#)
- [Service](#)
- [Service tag](#)
- [Module](#)
- [Action](#)

Available methods:

- [role.create](#) - create new user roles
- [role.delete](#) - delete user roles
- [role.get](#) - retrieve user roles
- [role.update](#) - update user roles

Role object

The following objects are directly related to the `role` API.

Role

The role object has the following properties:

Property	Type	Description
<code>roleid</code>	ID	ID of the role. Property behavior: - <i>read-only</i>
<code>name</code>	string	Name of the role. Property behavior: - <i>required</i> for update operations
<code>type</code>	integer	User type. Possible values: 1 - (<i>default</i>) User; 2 - Admin; 3 - Super admin. Property behavior: - <i>required</i> for create operations

Property	Type	Description
readonly	integer	Whether the role is readonly. Possible values: 0 - (default) No; 1 - Yes. Property behavior: - <i>read-only</i>

Role rules

The role rules object has the following properties:

Property	Type	Description
ui	array	Array of the UI element objects.
ui.default_access	integer	Whether access to new UI elements is enabled. Possible values: 0 - Disabled; 1 - (default) Enabled.
services.read.mode	integer	Read-only access to services. Possible values: 0 - Read-only access to the services, specified by the <code>services.read.list</code> or matched by the <code>services.read.tag</code> properties; 1 - (default) Read-only access to all services.
services.read.list	array	Array of Service objects. The specified services, including child services, will be granted a read-only access to the user role. Read-only access will not override read-write access to the services.
services.read.tag	object	Property behavior: - <i>supported</i> if <code>services.read.mode</code> is set to "0" Array of Service tag objects. The tag matched services, including child services, will be granted a read-only access to the user role. Read-only access will not override read-write access to the services. Property behavior: - <i>supported</i> if <code>services.read.mode</code> is set to "0"
services.write.mode	integer	Read-write access to services. Possible values: 0 - (default) Read-write access to the services, specified by the <code>services.write.list</code> or matched by the <code>services.write.tag</code> properties; 1 - Read-write access to all services.
services.write.list	array	Array of Service objects. The specified services, including child services, will be granted a read-write access to the user role. Read-write access will override read-only access to the services. Property behavior: - <i>supported</i> if <code>services.write.mode</code> is set to "0"

Property	Type	Description
services.write.tag	object	<p>Array of Service tag objects.</p> <p>The tag matched services, including child services, will be granted a read-write access to the user role. Read-write access will override read-only access to the services.</p> <p>Property behavior: - <i>supported</i> if <code>services.write.mode</code> is set to "0"</p>
modules	array	Array of the module objects.
modules.default_access	integer	Whether access to new modules is enabled.
		Possible values: 0 - Disabled; 1 - (<i>default</i>) Enabled.
api.access	integer	Whether access to API is enabled.
		Possible values: 0 - Disabled; 1 - (<i>default</i>) Enabled.
api.mode	integer	Mode for treating API methods listed in the <code>api</code> property.
		Possible values: 0 - (<i>default</i>) Deny list; 1 - Allow list.
api	array	Array of API methods.
actions	array	Array of the action objects.
actions.default_access	integer	Whether access to new actions is enabled.
		Possible values: 0 - Disabled; 1 - (<i>default</i>) Enabled.

UI element

The UI element object has the following properties:

Property	Type	Description
name	string	<p>Name of the UI element.</p> <p>Possible values if type of the Role object is set to "User", "Admin", or "Super admin":</p> <ul style="list-style-type: none"> monitoring.dashboard - <i>Dashboards</i>; monitoring.problems - <i>Monitoring</i> → <i>Problems</i>; monitoring.hosts - <i>Monitoring</i> → <i>Hosts</i>; monitoring.latest_data - <i>Monitoring</i> → <i>Latest data</i>; monitoring.maps - <i>Monitoring</i> → <i>Maps</i>; services.services - <i>Services</i> → <i>Services</i>; services.sla_report - <i>Services</i> → <i>SLA report</i>; inventory.overview - <i>Inventory</i> → <i>Overview</i>; inventory.hosts - <i>Inventory</i> → <i>Hosts</i>; reports.availability_report - <i>Reports</i> → <i>Availability report</i>; reports.top_triggers - <i>Reports</i> → <i>Triggers top 100</i>. <p>Possible values if type of the Role object is set to "Admin" or "Super admin":</p> <ul style="list-style-type: none"> monitoring.discovery - <i>Monitoring</i> → <i>Discovery</i>; services.sla - <i>Services</i> → <i>SLA</i>; reports.scheduled_reports - <i>Reports</i> → <i>Scheduled reports</i>; reports.notifications - <i>Reports</i> → <i>Notifications</i>; configuration.template_groups - <i>Data collection</i> → <i>Template groups</i>; configuration.host_groups - <i>Data collection</i> → <i>Host groups</i>; configuration.templates - <i>Data collection</i> → <i>Templates</i>; configuration.hosts - <i>Data collection</i> → <i>Hosts</i>; configuration.maintenance - <i>Data collection</i> → <i>Maintenance</i>; configuration.discovery - <i>Data collection</i> → <i>Discovery</i>; configuration.trigger_actions - <i>Alerts</i> → <i>Actions</i> → <i>Trigger actions</i>; configuration.service_actions - <i>Alerts</i> → <i>Actions</i> → <i>Service actions</i>; configuration.discovery_actions - <i>Alerts</i> → <i>Actions</i> → <i>Discovery actions</i>; configuration.autoregistration_actions - <i>Alerts</i> → <i>Actions</i> → <i>Autoregistration actions</i>; configuration.internal_actions - <i>Alerts</i> → <i>Actions</i> → <i>Internal actions</i>. <p>Possible values if type of the Role object is set to "Super admin":</p> <ul style="list-style-type: none"> reports.system_info - <i>Reports</i> → <i>System information</i>; reports.audit - <i>Reports</i> → <i>Audit log</i>; reports.action_log - <i>Reports</i> → <i>Action log</i>; configuration.event_correlation - <i>Data collection</i> → <i>Event correlation</i>; administration.media_types - <i>Alerts</i> → <i>Media types</i>; administration.scripts - <i>Alerts</i> → <i>Scripts</i>; administration.user_groups - <i>Users</i> → <i>User groups</i>; administration.user_roles - <i>Users</i> → <i>User roles</i>; administration.users - <i>Users</i> → <i>Users</i>; administration.api_tokens - <i>Users</i> → <i>API tokens</i>; administration.authentication - <i>Users</i> → <i>Authentication</i>; administration.general - <i>Administration</i> → <i>General</i>; administration.audit_log - <i>Administration</i> → <i>Audit log</i>; administration.housekeeping - <i>Administration</i> → <i>Housekeeping</i>; administration.proxies - <i>Administration</i> → <i>Proxies</i>; administration.macros - <i>Administration</i> → <i>Macros</i>; administration.queue - <i>Administration</i> → <i>Queue</i>.

Property behavior:

- required

Property	Type	Description
status	integer	Whether access to the UI element is enabled. Possible values: 0 - Disabled; 1 - <i>(default)</i> Enabled.

Service

Property	Type	Description
serviceid	ID	ID of the Service. Property behavior: <i>- required</i>

Service tag

Property	Type	Description
tag	string	Tag name. If empty string is specified, the service tag will not be used for service matching.
value	string	Property behavior: <i>- required</i> Tag value. If no value or empty string is specified, only the tag name will be used for service matching.

Module

The module object has the following properties:

Property	Type	Description
moduleid	ID	ID of the module.
status	integer	Property behavior: <i>- required</i> Whether access to the module is enabled. Possible values: 0 - Disabled; 1 - <i>(default)</i> Enabled.

Action

The action object has the following properties:

Property	Type	Description
name	string	<p>Name of the action.</p> <p>Possible values if type of the Role object is set to "User", "Admin", or "Super admin":</p> <ul style="list-style-type: none"> edit_dashboards - Create and edit dashboards; edit_maps - Create and edit maps; add_problem_comments - Add problem comments; change_severity - Change problem severity; acknowledge_problems - Acknowledge problems; suppress_problems - Suppress problems; close_problems - Close problems; execute_scripts - Execute scripts; manage_api_tokens - Manage API tokens. <p>Possible values if type of the Role object is set to "Admin" or "Super admin":</p> <ul style="list-style-type: none"> edit_maintenance - Create and edit maintenances; manage_scheduled_reports - Manage scheduled reports, manage_sla - Manage SLA. <p>Possible values if type of the Role object is set to "User" or "Admin":</p> <ul style="list-style-type: none"> invoke_execute_now - allows to execute item checks for users that have only read permissions on host. <p>Property behavior:</p> <ul style="list-style-type: none"> - <i>required</i>
status	integer	<p>Whether access to perform the action is enabled.</p> <p>Possible values:</p> <ul style="list-style-type: none"> 0 - Disabled; 1 - (<i>default</i>) Enabled.

role.create

Description

object role.create(object/array roles)

This method allows to create new roles.

Note:

This method is only available to *Super admin* user type. Permissions to call the method can be revoked in user role settings. See [User roles](#) for more information.

Parameters

(object/array) Roles to create.

Additionally to the [standard role properties](#), the method accepts the following parameters.

Parameter	Type	Description
rules	array	Role rules to be created for the role.

Return values

(object) Returns an object containing the IDs of the created roles under the `roleids` property. The order of the returned IDs matches the order of the passed roles.

Examples

Creating a role

Create a role with type "User" and denied access to two UI elements.

Request:

```
{
  "jsonrpc": "2.0",
  "method": "role.create",
  "params": {
    "name": "Operator",
    "type": "1",
    "rules": {
      "ui": [
        {
          "name": "monitoring.hosts",
          "status": "0"
        },
        {
          "name": "monitoring.maps",
          "status": "0"
        }
      ]
    }
  },
  "id": 1
}
```

Response:

```
{
  "jsonrpc": "2.0",
  "result": {
    "roleids": [
      "5"
    ]
  },
  "id": 1
}
```

See also

- [Role rules](#)
- [UI element](#)
- [Module](#)
- [Action](#)

Source

`CRole::create()` in `ui/include/classes/api/services/CRole.php`.

role.delete

Description

object `role.delete(array roleids)`

This method allows to delete roles.

Note:

This method is only available to *Super admin* user type. Permissions to call the method can be revoked in user role settings. See [User roles](#) for more information.

Parameters

(array) IDs of the roles to delete.

Return values

(object) Returns an object containing the IDs of the deleted roles under the `roleids` property.

Examples

Deleting multiple user roles

Delete two user roles.

Request:

```
{
  "jsonrpc": "2.0",
  "method": "role.delete",
  "params": [
    "4",
    "5"
  ],
  "id": 1
}
```

Response:

```
{
  "jsonrpc": "2.0",
  "result": {
    "roleids": [
      "4",
      "5"
    ]
  },
  "id": 1
}
```

Source

CRole::delete() in *ui/include/classes/api/services/CRole.php*.

role.get

Description

integer/array role.get(object parameters)

The method allows to retrieve roles according to the given parameters.

Note:

This method is available to users of any type. Permissions to call the method can be revoked in user role settings. See [User roles](#) for more information.

Parameters

(object) Parameters defining the desired output.

The method supports the following parameters.

Parameter	Type	Description
roleids	ID/array	Return only roles with the given IDs.
selectRules	query	Return a rules property with the role rules.
selectUsers	query	Return a users property with the users that the role is assigned to.
sortfield	string/array	Sort the result by the given properties. Possible values: roleid, name.
countOutput	boolean	These parameters being common for all get methods are described in detail in the reference commentary page.
editable	boolean	
excludeSearch	boolean	
filter	object	
limit	integer	
output	query	
preservekeys	boolean	
search	object	

Parameter	Type	Description
searchByAny	boolean	
searchWildcardsEnabled	boolean	
sortorder	string/array	
startSearch	boolean	

Return values

(integer/array) Returns either:

- an array of objects;
- the count of retrieved objects, if the `countOutput` parameter has been used.

Examples

Retrieving role data

Retrieve "Super admin role" role data and its access rules.

Request:

```
{
  "jsonrpc": "2.0",
  "method": "role.get",
  "params": {
    "output": "extend",
    "selectRules": "extend",
    "roleids": "3"
  },
  "id": 1
}
```

Response:

```
{
  "jsonrpc": "2.0",
  "result": [
    {
      "roleid": "3",
      "name": "Super admin role",
      "type": "3",
      "readonly": "1",
      "rules": {
        "ui": [
          {
            "name": "monitoring.dashboard",
            "status": "1"
          },
          {
            "name": "monitoring.problems",
            "status": "1"
          },
          {
            "name": "monitoring.hosts",
            "status": "1"
          },
          {
            "name": "monitoring.latest_data",
            "status": "1"
          },
          {
            "name": "monitoring.maps",
            "status": "1"
          },
          {
            "name": "services.services",

```



```
    "status": "1"
  },
  {
    "name": "services.sla_report",
    "status": "1"
  },
  {
    "name": "inventory.overview",
    "status": "1"
  },
  {
    "name": "inventory.hosts",
    "status": "1"
  },
  {
    "name": "reports.availability_report",
    "status": "1"
  },
  {
    "name": "reports.top_triggers",
    "status": "1"
  },
  {
    "name": "monitoring.discovery",
    "status": "1"
  },
  {
    "name": "services.sla",
    "status": "1"
  },
  {
    "name": "reports.scheduled_reports",
    "status": "1"
  },
  {
    "name": "reports.notifications",
    "status": "1"
  },
  {
    "name": "configuration.template_groups",
    "status": "1"
  },
  {
    "name": "configuration.host_groups",
    "status": "1"
  },
  {
    "name": "configuration.templates",
    "status": "1"
  },
  {
    "name": "configuration.hosts",
    "status": "1"
  },
  {
    "name": "configuration.maintenance",
    "status": "1"
  },
  {
    "name": "configuration.discovery",
    "status": "1"
  },
},
```

```
{
  "name": "configuration.trigger_actions",
  "status": "1"
},
{
  "name": "configuration.service_actions",
  "status": "1"
},
{
  "name": "configuration.discovery_actions",
  "status": "1"
},
{
  "name": "configuration.autoregistration_actions",
  "status": "1"
},
{
  "name": "configuration.internal_actions",
  "status": "1"
},
{
  "name": "reports.system_info",
  "status": "1"
},
{
  "name": "reports.audit",
  "status": "1"
},
{
  "name": "reports.action_log",
  "status": "1"
},
{
  "name": "configuration.event_correlation",
  "status": "1"
},
{
  "name": "administration.media_types",
  "status": "1"
},
{
  "name": "administration.scripts",
  "status": "1"
},
{
  "name": "administration.user_groups",
  "status": "1"
},
{
  "name": "administration.user_roles",
  "status": "1"
},
{
  "name": "administration.users",
  "status": "1"
},
{
  "name": "administration.api_tokens",
  "status": "1"
},
{
  "name": "administration.authentication",
```

```

        "status": "1"
    },
    {
        "name": "administration.general",
        "status": "1"
    },
    {
        "name": "administration.audit_log",
        "status": "1"
    },
    {
        "name": "administration.housekeeping",
        "status": "1"
    },
    {
        "name": "administration.proxies",
        "status": "1"
    },
    {
        "name": "administration.macros",
        "status": "1"
    },
    {
        "name": "administration.queue",
        "status": "1"
    }
},
"ui.default_access": "1",
"services.read.mode": "1",
"services.read.list": [],
"services.read.tag": {
    "tag": "",
    "value": ""
},
"services.write.mode": "1",
"services.write.list": [],
"services.write.tag": {
    "tag": "",
    "value": ""
},
"modules": [],
"modules.default_access": "1",
"api.access": "1",
"api.mode": "0",
"api": [],
"actions": [
    {
        "name": "edit_dashboards",
        "status": "1"
    },
    {
        "name": "edit_maps",
        "status": "1"
    },
    {
        "name": "acknowledge_problems",
        "status": "1"
    },
    {
        "name": "suppress_problems",
        "status": "1"
    }
],

```

```

        {
            "name": "close_problems",
            "status": "1"
        },
        {
            "name": "change_severity",
            "status": "1"
        },
        {
            "name": "add_problem_comments",
            "status": "1"
        },
        {
            "name": "execute_scripts",
            "status": "1"
        },
        {
            "name": "manage_api_tokens",
            "status": "1"
        },
        {
            "name": "edit_maintenance",
            "status": "1"
        },
        {
            "name": "manage_scheduled_reports",
            "status": "1"
        },
        {
            "name": "manage_sla",
            "status": "1"
        },
        {
            "name": "invoke_execute_now",
            "status": "1"
        }
    ],
    "actions.default_access": "1"
}
    }
],
    "id": 1
}

```

See also

- [Role rules](#)
- [User](#)

Source

CRole::get() in *ui/include/classes/api/services/CRole.php*.

role.update

Description

object role.update(object/array roles)

This method allows to update existing roles.

Note:

This method is only available to *Super admin* user type. Permissions to call the method can be revoked in user role settings. See [User roles](#) for more information.

Parameters

(object/array) Role properties to be updated.

The `roleid` property must be defined for each role, all other properties are optional. Only the passed properties will be updated, all others will remain unchanged.

Additionally to the **standard role properties** the method accepts the following parameters.

Parameter	Type	Description
<code>rules</code>	array	Access rules to update for the role.

Return values

(object) Returns an object containing the IDs of the updated roles under the `roleids` property.

Examples

Disabling ability to execute scripts

Update role with ID "5", disable ability to execute scripts.

Request:

```
{
  "jsonrpc": "2.0",
  "method": "role.update",
  "params": [
    {
      "roleid": "5",
      "rules": {
        "actions": [
          {
            "name": "execute_scripts",
            "status": "0"
          }
        ]
      }
    }
  ],
  "id": 1
}
```

Response:

```
{
  "jsonrpc": "2.0",
  "result": {
    "roleids": [
      "5"
    ]
  },
  "id": 1
}
```

Limiting access to API

Update role with ID "5", deny to call any "create", "update" or "delete" methods.

Request:

```
{
  "jsonrpc": "2.0",
  "method": "role.update",
  "params": [
    {
      "roleid": "5",
      "rules": {
        "api.access": "1",

```

```

        "api.mode": "0",
        "api": ["*.create", "/*.update", "/*.delete"]
    }
}
],
"id": 1
}

```

Response:

```

{
  "jsonrpc": "2.0",
  "result": {
    "roleids": [
      "5"
    ]
  },
  "id": 1
}

```

Source

CRole::update() in *ui/include/classes/api/services/CRole.php*.

Script

This class is designed to work with scripts.

Object references:

- [Script](#)
- [Webhook parameters](#)
- [Debug](#)
- [Log entry](#)

Available methods:

- [script.create](#) - create new scripts
- [script.delete](#) - delete scripts
- [script.execute](#) - run scripts
- [script.get](#) - retrieve scripts
- [script.getscriptsbyevents](#) - retrieve scripts for events
- [script.getscriptsbyhosts](#) - retrieve scripts for hosts
- [script.update](#) - update scripts

Script object

The following objects are directly related to the script API.

Script

The script object has the following properties.

Property	Type	Description
scriptid	ID	ID of the script.
		Property behavior: - <i>read-only</i> - <i>required</i> for update operations
name	string	Name of the script.
		Property behavior: - <i>required</i> for create operations

Property	Type	Description
type	integer	<p>Script type.</p> <p>Possible values if scope is set to "action operation":</p> <ul style="list-style-type: none"> 0 - Script; 1 - IPMI; 2 - SSH; 3 - TELNET; 5 - Webhook. <p>Possible values if scope is set to "manual host action" or "manual event action":</p> <ul style="list-style-type: none"> 6 - URL. <p>Property behavior:</p> <ul style="list-style-type: none"> - <i>required</i> for create operations
command	string	<p>Command to run.</p> <p>Property behavior:</p> <ul style="list-style-type: none"> - <i>required</i> if type is set to "Script", "IPMI", "SSH", "TELNET", or "Webhook"
scope	integer	<p>Script scope.</p> <p>Possible values:</p> <ul style="list-style-type: none"> 1 - action operation; 2 - manual host action; 4 - manual event action. <p>Property behavior:</p> <ul style="list-style-type: none"> - <i>required</i> for create operations
execute_on	integer	<p>Where to run the script.</p> <p>Possible values:</p> <ul style="list-style-type: none"> 0 - run on Zabbix agent; 1 - run on Zabbix server. It is <i>supported</i> only if execution of global scripts is enabled on Zabbix server; 2 - (<i>default</i>) run on Zabbix server or proxy. <p>Property behavior:</p> <ul style="list-style-type: none"> - <i>supported</i> if type is set to "Script"
menu_path	string	<p>Folders separated by slash that form a menu like navigation in frontend when clicked on host or event.</p> <p>Property behavior:</p> <ul style="list-style-type: none"> - <i>supported</i> if scope is set to "manual host action" or "manual event action"
authtype	integer	<p>Authentication method used for SSH script type.</p> <p>Possible values:</p> <ul style="list-style-type: none"> 0 - password; 1 - public key. <p>Property behavior:</p> <ul style="list-style-type: none"> - <i>supported</i> if type is set to "SSH"
username	string	<p>User name used for authentication.</p> <p>Property behavior:</p> <ul style="list-style-type: none"> - <i>required</i> if type is set to "SSH" or "TELNET"

Property	Type	Description
password	string	Password used for SSH scripts with password authentication and TELNET scripts.
publickey	string	<p>Property behavior:</p> <p>- <i>supported</i> if <code>type</code> is set to "SSH" and <code>auth_type</code> is set to "password", or <code>type</code> is set to "TELNET"</p> <p>Name of the public key file used for SSH scripts with public key authentication.</p> <p>Property behavior:</p> <p>- <i>required</i> if <code>type</code> is set to "SSH" and <code>auth_type</code> is set to "public key"</p>
privatekey	string	<p>Name of the private key file used for SSH scripts with public key authentication.</p> <p>Property behavior:</p> <p>- <i>required</i> if <code>type</code> is set to "SSH" and <code>auth_type</code> is set to "public key"</p>
port	string	<p>Port number used for SSH and TELNET scripts.</p> <p>Property behavior:</p> <p>- <i>supported</i> if <code>type</code> is set to "SSH" or "TELNET"</p>
groupid	ID	<p>ID of the host group that the script can be run on.</p> <p>If set to "0", the script will be available on all host groups.</p> <p>Default: 0.</p>
usrgrp_id	ID	<p>ID of the user group that will be allowed to run the script.</p> <p>If set to "0", the script will be available for all user groups.</p> <p>Default: 0.</p> <p>Property behavior:</p> <p>- <i>supported</i> if <code>scope</code> is set to "manual host action" or "manual event action"</p>
host_access	integer	<p>Host permissions needed to run the script.</p> <p>Possible values:</p> <p>2 - (<i>default</i>) read;</p> <p>3 - write.</p> <p>Property behavior:</p> <p>- <i>supported</i> if <code>scope</code> is set to "manual host action" or "manual event action"</p>
confirmation	string	<p>Confirmation pop up text.</p> <p>The pop up will appear when trying to run the script from the Zabbix frontend.</p> <p>Property behavior:</p> <p>- <i>supported</i> if <code>scope</code> is set to "manual host action" or "manual event action"</p>
timeout	string	<p>Webhook script execution timeout in seconds. Time suffixes are supported (e.g., 30s, 1m).</p> <p>Possible values: 1-60s.</p> <p>Default: 30s.</p> <p>Property behavior:</p> <p>- <i>required</i> if <code>type</code> is set to "Webhook"</p>

Property	Type	Description
parameters	array	Array of webhook input parameters .
description	string	Property behavior: - <i>supported</i> if type is set to "Webhook"
url	string	Description of the script. User defined URL. Property behavior: - <i>required</i> if type is set to "URL"
new_window	integer	Open URL in a new window. Possible values: 0 - No; 1 - (<i>default</i>) Yes. Property behavior: - <i>supported</i> if type is set to "URL"
manualinput	integer	Indicates whether the script accepts user-provided input. Possible values: 0 - (<i>default</i>) Disabled; 1 - Enabled; Property behavior: - <i>supported</i> if scope is set to "manual host action" or "manual event action"
manualinput_prompt	string	Manual input prompt text. Property behavior: - <i>required</i> if manualinput is set to "Enabled"
manualinput_validator	string	A character string field used to validate the user provided input. The string consists of either a regular expression or a set of values separated by commas. Property behavior: - <i>required</i> if manualinput is set to "Enabled"
manualinput_validator_type	integer	Determines the type of user input expected. Possible values: 0 - (<i>default</i>) String. Indicates that manualinput_validator is to be treated as a regular expression; 1 - List. Indicates that manualinput_validator is to be treated as a comma-separated list of possible input values. Property behavior: - <i>supported</i> if manualinput is set to "Enabled"
manualinput_default_value	string	Default value for auto-filling user input. Property behavior: - <i>supported</i> if manualinput_validator_type is set to "String"

Webhook parameters

Parameters passed to webhook script when it is called have the following properties.

Property	Type	Description
name	string	Parameter name. Property behavior: - <i>required</i>
value	string	Parameter value. Supports macros .

Debug

Debug information of executed webhook script. The debug object has the following properties.

Property	Type	Description
logs	array	Array of log entries .
ms	string	Script execution duration in milliseconds.

Log entry

The log entry object has the following properties.

Property	Type	Description
level	integer	Log level.
ms	string	The time elapsed in milliseconds since the script was run before log entry was added.
message	string	Log message.

script.create

Description

object script.create(object/array scripts)

This method allows to create new scripts.

Note:

This method is only available to *Super admin* user type. Permissions to call the method can be revoked in user role settings. See [User roles](#) for more information.

Parameters

(object/array) Scripts to create.

The method accepts scripts with the [standard script properties](#).

Return values

(object) Returns an object containing the IDs of the created scripts under the `scriptids` property. The order of the returned IDs matches the order of the passed scripts.

Examples

Create a webhook script

Create a webhook script that sends HTTP request to external service.

Request:

```
{
  "jsonrpc": "2.0",
  "method": "script.create",
  "params": {
    "name": "Webhook script",
    "command": "try {\n var request = new HttpRequest(),\n response,\n data;\n\n request.addHeader('Co",
    "type": 5,
    "timeout": "40s",
    "parameters": [
      {
        "name": "token",
        "value": "${WEBHOOK.TOKEN}"
      },
      {
        "name": "host",
        "value": "${HOST.HOST}"
      }
    ]
  }
}
```

```
    {
      "name": "v",
      "value": "2.2"
    }
  ],
  "id": 1
}
```

Response:

```
{
  "jsonrpc": "2.0",
  "result": {
    "scriptids": [
      "3"
    ]
  },
  "id": 1
}
```

Create an SSH script

Create an SSH script with public key authentication that can be executed on a host and has a context menu.

Request:

```
{
  "jsonrpc": "2.0",
  "method": "script.create",
  "params": {
    "name": "SSH script",
    "command": "my script command",
    "type": 2,
    "authtype": 1,
    "username": "John",
    "publickey": "pub.key",
    "privatekey": "priv.key",
    "password": "secret",
    "port": "12345",
    "scope": 2,
    "menu_path": "All scripts/SSH",
    "usrgrpid": "7",
    "groupid": "4"
  },
  "id": 1
}
```

Response:

```
{
  "jsonrpc": "2.0",
  "result": {
    "scriptids": [
      "5"
    ]
  },
  "id": 1
}
```

Create a custom script

Create a custom script that will reboot a server. The script will require write access to the host and will prompt the user for manual input. Upon successful input submission, script will display confirmation message in the frontend.

Request:

```

{
  "jsonrpc": "2.0",
  "method": "script.create",
  "params": {
    "name": "Reboot server",
    "command": "reboot server {MANUALINPUT}",
    "type": 0,
    "scope": 2,
    "confirmation": "Are you sure you would like to reboot the server {MANUALINPUT}?",
    "manualinput": 1,
    "manualinput_prompt": "Which server you want to reboot?",
    "manualinput_validator": "[1-9]",
    "manualinput_validator_type": 0,
    "manualinput_default_value": "1"
  },
  "id": 1
}

```

Response:

```

{
  "jsonrpc": "2.0",
  "result": {
    "scriptids": [
      "4"
    ]
  },
  "id": 1
}

```

Create a URL type script

Create a URL type script for host scope that remains in the same window and has confirmation text.

Request:

```

{
  "jsonrpc": "2.0",
  "method": "script.create",
  "params": {
    "name": "URL script",
    "type": 6,
    "scope": 2,
    "url": "http://zabbix/ui/zabbix.php?action=host.edit&hostid={HOST.ID}",
    "confirmation": "Edit host {HOST.NAME}?",
    "new_window": 0
  },
  "id": 1
}

```

Response:

```

{
  "jsonrpc": "2.0",
  "result": {
    "scriptids": [
      "56"
    ]
  },
  "id": 1
}

```

Create a URL type script with manual input

Create a URL type script for event scope that opens in a new window and has manual input.

Request:

```

{
  "jsonrpc": "2.0",
  "method": "script.create",
  "params": {
    "name": "URL script with manual input",
    "type": 6,
    "scope": 4,
    "url": "http://zabbix/ui/zabbix.php?action={MANUALINPUT}",
    "new_window": 1,
    "manualinput": 1,
    "manualinput_prompt": "Select a page to open:",
    "manualinput_validator": "dashboard.view,script.list,actionlog.list",
    "manualinput_validator_type": 1
  },
  "id": 1
}

```

Response:

```

{
  "jsonrpc": "2.0",
  "result": {
    "scriptids": [
      "57"
    ]
  },
  "id": 1
}

```

Source

CScript::create() in `ui/include/classes/api/services/CScript.php`.

script.delete

Description

object script.delete(array scriptIds)

This method allows to delete scripts.

Note:

This method is only available to *Super admin* user type. Permissions to call the method can be revoked in user role settings. See [User roles](#) for more information.

Parameters

(array) IDs of the scripts to delete.

Return values

(object) Returns an object containing the IDs of the deleted scripts under the `scriptids` property.

Examples

Delete multiple scripts

Delete two scripts.

Request:

```

{
  "jsonrpc": "2.0",
  "method": "script.delete",
  "params": [
    "3",
    "4"
  ],

```

```
"id": 1
}
```

Response:

```
{
  "jsonrpc": "2.0",
  "result": {
    "scriptids": [
      "3",
      "4"
    ]
  },
  "id": 1
}
```

Source

CScript::delete() in `ui/include/classes/api/services/CScript.php`.

script.execute

Description

object script.execute(object parameters)

This method allows to run a script on a host or event. Except for URL type scripts. Those are not executable.

Note:

This method is available to users of any type. Permissions to call the method can be revoked in user role settings. See [User roles](#) for more information.

Parameters

(object) Parameters containing the ID of the script to run, either the ID of the host or the ID of the event and manualinput value.

Parameter	Type	Description
scriptid	ID	ID of the script to run. Parameter behavior: - <i>required</i>
hostid	ID	ID of the host to run the script on. Parameter behavior: - <i>required</i> if eventid is not set
eventid	ID	ID of the event to run the script on. Parameter behavior: - <i>required</i> if hostid is not set
manualinput	string	User-provided value to run the script with, substituting the {MANUALINPUT} macro.

Return values

(object) Returns the result of script execution.

Property	Type	Description
response	string	Whether the script was run successfully. Possible value - success .
value	string	Script output.
debug	object	Contains a debug object if a webhook script is executed. For other script types, it contains empty object.

Examples

Run a webhook script

Run a webhook script that sends HTTP request to external service.

Request:

```
{
  "jsonrpc": "2.0",
  "method": "script.execute",
  "params": {
    "scriptid": "4",
    "hostid": "30079"
  },
  "id": 1
}
```

Response:

```
{
  "jsonrpc": "2.0",
  "result": {
    "response": "success",
    "value": "{\"status\":\"sent\",\"timestamp\":\"1611235391\"}",
    "debug": {
      "logs": [
        {
          "level": 3,
          "ms": 480,
          "message": "[Webhook Script] HTTP status: 200."
        }
      ],
      "ms": 495
    }
  },
  "id": 1
}
```

Run a custom script

Run a "ping" script on a host.

Request:

```
{
  "jsonrpc": "2.0",
  "method": "script.execute",
  "params": {
    "scriptid": "1",
    "hostid": "30079"
  },
  "id": 1
}
```

Response:

```
{
  "jsonrpc": "2.0",
  "result": {
    "response": "success",
    "value": "PING 127.0.0.1 (127.0.0.1) 56(84) bytes of data.\n64 bytes from 127.0.0.1: icmp_req=1 tt",
    "debug": []
  },
  "id": 1
}
```

Run a custom script with manual input

Run a "ping" script with command "ping -c {MANUALINPUT} {HOST.CONN}; case \$? in [01]) true;; *) false;; esac" on a host.

Request:

```
{
  "jsonrpc": "2.0",
  "method": "script.execute",
  "params": {
    "scriptid": "7",
    "hostid": "30079",
    "manualinput": "2"
  },
  "id": 1
}
```

Response:

```
{
  "jsonrpc": "2.0",
  "result": {
    "response": "success",
    "value": "PING 127.0.0.1 (127.0.0.1) 56(84) bytes of data.\n64 bytes from 127.0.0.1: icmp_seq=1 tt",
    "debug": []
  },
  "id": 1
}
```

Source

CScript::execute() in ui/include/classes/api/services/CScript.php.

script.get

Description

integer/array script.get(object parameters)

The method allows to retrieve scripts according to the given parameters.

Note:

This method is available to users of any type. Permissions to call the method can be revoked in user role settings. See [User roles](#) for more information.

Parameters

(object) Parameters defining the desired output.

The method supports the following parameters.

Parameter	Type	Description
groupids	ID/array	Return only scripts that can be run on the given host groups.
hostids	ID/array	Return only scripts that can be run on the given hosts.
scriptids	ID/array	Return only scripts with the given IDs.
usrgrpids	ID/array	Return only scripts that can be run by users in the given user groups.
selectHostGroups	query	Return a hostgroups property with host groups that the script can be run on.
selectHosts	query	Return a hosts property with hosts that the script can be run on.
selectActions	query	Return an actions property with actions that the script is associated with.
sortfield	string/array	Sort the result by the given properties.
countOutput	boolean	Possible values: scriptid , name . These parameters being common for all get methods are described in detail in the reference commentary .
editable	boolean	
excludeSearch	boolean	

Parameter	Type	Description
filter	object	
limit	integer	
output	query	
preservekeys	boolean	
search	object	
searchByAny	boolean	
searchWildcardsEnabled	boolean	
sortorder	string/array	
startSearch	boolean	

Return values

(integer/array) Returns either:

- an array of objects;
- the count of retrieved objects, if the `countOutput` parameter has been used.

Examples

Retrieve all scripts

Retrieve all configured scripts.

Request:

```
{
  "jsonrpc": "2.0",
  "method": "script.get",
  "params": {
    "output": "extend"
  },
  "id": 1
}
```

Response:

```
{
  "jsonrpc": "2.0",
  "result": [
    {
      "scriptid": "1",
      "name": "Ping",
      "command": "/bin/ping -c 3 {HOST.CONN} 2>&1",
      "host_access": "2",
      "usrgrpid": "0",
      "groupid": "0",
      "description": "",
      "confirmation": "",
      "type": "0",
      "execute_on": "1",
      "timeout": "30s",
      "scope": "2",
      "port": "",
      "authtype": "0",
      "username": "",
      "password": "",
      "publickey": "",
      "privatekey": "",
      "menu_path": "",
      "url": "",
      "new_window": "1",
      "manualinput": "0",
      "manualinput_prompt": "",
      "manualinput_validator": "",
      "manualinput_validator_type": "0",
    }
  ]
}
```

```

    "manualinput_default_value": "",
    "parameters": []
  },
  {
    "scriptid": "2",
    "name": "Traceroute",
    "command": "/usr/bin/traceroute {HOST.CONN} 2>&1",
    "host_access": "2",
    "usrgrp": "0",
    "groupid": "0",
    "description": "",
    "confirmation": "",
    "type": "0",
    "execute_on": "1",
    "timeout": "30s",
    "scope": "2",
    "port": "",
    "authtype": "0",
    "username": "",
    "password": "",
    "publickey": "",
    "privatekey": "",
    "menu_path": "",
    "url": "",
    "new_window": "1",
    "manualinput": "0",
    "manualinput_prompt": "",
    "manualinput_validator": "",
    "manualinput_validator_type": "0",
    "manualinput_default_value": "",
    "parameters": []
  },
  {
    "scriptid": "3",
    "name": "Detect operating system",
    "command": "sudo /usr/bin/nmap -O {HOST.CONN} 2>&1",
    "host_access": "2",
    "usrgrp": "7",
    "groupid": "0",
    "description": "",
    "confirmation": "",
    "type": "0",
    "execute_on": "1",
    "timeout": "30s",
    "scope": "2",
    "port": "",
    "authtype": "0",
    "username": "",
    "password": "",
    "publickey": "",
    "privatekey": "",
    "menu_path": "",
    "url": "",
    "new_window": "1",
    "manualinput": "0",
    "manualinput_prompt": "",
    "manualinput_validator": "",
    "manualinput_validator_type": "0",
    "manualinput_default_value": "",
    "parameters": []
  },
  {

```

```

"scriptid": "4",
"name": "Webhook",
"command": "try {\n var request = new HttpRequest(),\n response,\n data;\n\n request.addHeader
"host_access": "2",
"usrgrp": "7",
"groupid": "0",
"description": "",
"confirmation": "",
"type": "5",
"execute_on": "1",
"timeout": "30s",
"scope": "2",
"port": "",
"authtype": "0",
"username": "",
"password": "",
"publickey": "",
"privatekey": "",
"menu_path": "",
"url": "",
"new_window": "1",
"manualinput": "0",
"manualinput_prompt": "",
"manualinput_validator": "",
"manualinput_validator_type": "0",
"manualinput_default_value": "",
"parameters": [
  {
    "name": "token",
    "value": "${WEBHOOK.TOKEN}"
  },
  {
    "name": "host",
    "value": "${HOST.HOST}"
  },
  {
    "name": "v",
    "value": "2.2"
  }
]
},
{
"scriptid": "5",
"name": "URL",
"command": "",
"host_access": "2",
"usrgrp": "0",
"groupid": "0",
"description": "",
"confirmation": "Go to {HOST.NAME}?",
"type": "6",
"execute_on": "1",
"timeout": "30s",
"scope": "4",
"port": "",
"authtype": "0",
"username": "",
"password": "",
"publickey": "",
"privatekey": "",
"menu_path": "",
"url": "http://zabbix/ui/zabbix.php?action=latest.view&hostids[]={HOST.ID}",

```

```

    "new_window": "0",
    "manualinput": "0",
    "manualinput_prompt": "",
    "manualinput_validator": "",
    "manualinput_validator_type": "0",
    "manualinput_default_value": "",
    "parameters": []
  },
  {
    "scriptid": "6",
    "name": "URL with user input",
    "command": "",
    "host_access": "2",
    "usrgrpid": "0",
    "groupid": "0",
    "description": "",
    "confirmation": "Open zabbix page {MANUALINPUT}?",
    "type": "6",
    "execute_on": "1",
    "timeout": "30s",
    "scope": "2",
    "port": "",
    "authtype": "0",
    "username": "",
    "password": "",
    "publickey": "",
    "privatekey": "",
    "menu_path": "",
    "url": "http://zabbix/ui/zabbix.php?action={MANUALINPUT}",
    "new_window": "0",
    "manualinput": "1",
    "manualinput_prompt": "Select a page to open:",
    "manualinput_validator": "dashboard.view,script.list,actionlog.list",
    "manualinput_validator_type": "1",
    "parameters": []
  }
],
"id": 1
}

```

See also

- [Host](#)
- [Host group](#)

Source

CScript::get() in `ui/include/classes/api/services/CScript.php`.

script.getscriptsbyevents

Description

object script.getscriptsbyevents(object parameters)

This method allows to retrieve all available scripts on the given event or specific script if script ID is provided. When manualinput is provided, it substitutes the {MANUALINPUT} macro with the specified value.

Note:

This method is available to users of any type. Permissions to call the method can be revoked in user role settings. See [User roles](#) for more information.

Parameters

(object/array) The method accepts object or array of objects with the following parameters.

Parameter	Type	Description
eventid	ID	ID of event to return scripts for. Must be unique.
scriptid	ID	ID of script to return.
manualinput	string	Value of the user-provided {MANUALINPUT} macro value.

Parameter behavior:
- *required*

Return values

(object) Returns an object with event IDs as properties and arrays of available scripts as values. If script ID is provided, the associated value is an array containing the specific script.

Note:

The method will automatically expand macros in the confirmation text, manualinput prompt text and url. If the manualinput parameter is provided, the {MANUALINPUT} macro will be resolved to the specified value.

Examples

Retrieve scripts by event IDs

Retrieve all scripts available to events "632" and "614".

Request:

```
{
  "jsonrpc": "2.0",
  "method": "script.getscriptsbyevents",
  "params": [
    {
      "eventid": "632"
    },
    {
      "eventid": "614"
    }
  ],
  "id": 1
}
```

Response:

```
{
  "jsonrpc": "2.0",
  "result": {
    "632": [
      {
        "scriptid": "3",
        "name": "Detect operating system",
        "command": "sudo /usr/bin/nmap -O {HOST.CONN} 2>&1",
        "host_access": "2",
        "usrgrpuid": "7",
        "groupid": "0",
        "description": "",
        "confirmation": "",
        "type": "0",
        "execute_on": "1",
        "timeout": "30s",
        "scope": "4",
        "port": "",
        "authtype": "0",
        "username": "",
        "password": "",
        "publickey": "",
        "privatekey": "",

```

```

    "menu_path": "",
    "url": "",
    "new_window": "1",
    "manualinput": "0",
    "manualinput_prompt": "",
    "manualinput_validator_type": "0",
    "manualinput_validator": "",
    "manualinput_default_value": "",
    "parameters": []
  },
  {
    "scriptid": "1",
    "name": "Ping",
    "command": "/bin/ping -c 3 {HOST.CONN} 2>&1",
    "host_access": "2",
    "usrgrpuid": "0",
    "groupuid": "0",
    "description": "",
    "confirmation": "",
    "type": "0",
    "execute_on": "1",
    "timeout": "30s",
    "scope": "4",
    "port": "",
    "authtype": "0",
    "username": "",
    "password": "",
    "publickey": "",
    "privatekey": "",
    "menu_path": "",
    "url": "",
    "new_window": "1",
    "manualinput": "0",
    "manualinput_prompt": "",
    "manualinput_validator_type": "0",
    "manualinput_validator": "",
    "manualinput_default_value": "",
    "parameters": []
  },
  {
    "scriptid": "4",
    "name": "Open Zabbix page",
    "command": "",
    "host_access": "2",
    "usrgrpuid": "0",
    "groupuid": "0",
    "description": "",
    "confirmation": "Are you sure you want to open page *UNKNOWN*?",
    "type": "6",
    "execute_on": "2",
    "timeout": "30s",
    "scope": "4",
    "port": "",
    "authtype": "0",
    "username": "",
    "password": "",
    "publickey": "",
    "privatekey": "",
    "menu_path": "",
    "url": "http://localhost/ui/zabbix.php?action=*UNKNOWN*",
    "new_window": "1",
    "manualinput": "1",

```

```

    "manualinput_prompt": "Zabbix page to open:",
    "manualinput_validator_type": "1",
    "manualinput_validator": "dashboard.view,discovery.view",
    "manualinput_default_value": "",
    "parameters": []
  },
  {
    "scriptid": "2",
    "name": "Traceroute",
    "command": "/usr/bin/traceroute {HOST.CONN} 2>&1",
    "host_access": "2",
    "usrgrp": "0",
    "groupid": "0",
    "description": "",
    "confirmation": "",
    "type": "0",
    "execute_on": "1",
    "timeout": "30s",
    "scope": "4",
    "port": "",
    "authtype": "0",
    "username": "",
    "password": "",
    "publickey": "",
    "privatekey": "",
    "menu_path": "",
    "url": "",
    "new_window": "1",
    "manualinput": "0",
    "manualinput_prompt": "",
    "manualinput_validator_type": "0",
    "manualinput_validator": "",
    "manualinput_default_value": "",
    "parameters": []
  }
],
"614": [
  {
    "scriptid": "3",
    "name": "Detect operating system",
    "command": "sudo /usr/bin/nmap -O {HOST.CONN} 2>&1",
    "host_access": "2",
    "usrgrp": "7",
    "groupid": "0",
    "description": "",
    "confirmation": "",
    "type": "0",
    "execute_on": "1",
    "timeout": "30s",
    "scope": "4",
    "port": "",
    "authtype": "0",
    "username": "",
    "password": "",
    "publickey": "",
    "privatekey": "",
    "menu_path": "",
    "url": "",
    "new_window": "1",
    "manualinput": "0",
    "manualinput_prompt": "",
    "manualinput_validator_type": "1",

```

```

    "manualinput_validator": "",
    "manualinput_default_value": "",
    "parameters": []
  },
  {
    "scriptid": "1",
    "name": "Ping",
    "command": "/bin/ping -c 3 {HOST.CONN} 2>&1",
    "host_access": "2",
    "usrgrpuid": "0",
    "groupid": "0",
    "description": "",
    "confirmation": "",
    "type": "0",
    "execute_on": "1",
    "timeout": "30s",
    "scope": "4",
    "port": "",
    "authtype": "0",
    "username": "",
    "password": "",
    "publickey": "",
    "privatekey": "",
    "menu_path": "",
    "url": "",
    "new_window": "1",
    "manualinput": "0",
    "manualinput_prompt": "",
    "manualinput_validator_type": "0",
    "manualinput_validator": "",
    "manualinput_default_value": "",
    "parameters": []
  },
  {
    "scriptid": "4",
    "name": "Open Zabbix page",
    "command": "",
    "host_access": "2",
    "usrgrpuid": "0",
    "groupid": "0",
    "description": "",
    "confirmation": "Are you sure you want to open page *UNKNOWN*?",
    "type": "6",
    "execute_on": "2",
    "timeout": "30s",
    "scope": "4",
    "port": "",
    "authtype": "0",
    "username": "",
    "password": "",
    "publickey": "",
    "privatekey": "",
    "menu_path": "",
    "url": "http://localhost/ui/zabbix.php?action=*UNKNOWN*",
    "new_window": "1",
    "manualinput": "1",
    "manualinput_prompt": "Zabbix page to open:",
    "manualinput_validator_type": "1",
    "manualinput_validator": "dashboard.view,discovery.view",
    "manualinput_default_value": "",
    "parameters": []
  },
}

```



```

    {
      "scriptid": "2",
      "name": "Traceroute",
      "command": "/usr/bin/traceroute {HOST.CONN} 2>&1",
      "host_access": "2",
      "usrgrp": "0",
      "group": "0",
      "description": "",
      "confirmation": "",
      "type": "0",
      "execute_on": "1",
      "timeout": "30s",
      "scope": "4",
      "port": "",
      "auth": "0",
      "username": "",
      "password": "",
      "publickey": "",
      "privatekey": "",
      "menu_path": "",
      "url": "",
      "new_window": "1",
      "manualinput": "0",
      "manualinput_prompt": "",
      "manualinput_validator_type": "0",
      "manualinput_validator": "",
      "manualinput_default_value": "",
      "parameters": []
    }
  ],
  "id": 1
}

```

Retrieve specific script with manualinput value.

Retrieve script with ID "4" on event "632" with manualinput value "dashboard.view".

Request:

```

{
  "jsonrpc": "2.0",
  "method": "script.getscriptsbyevents",
  "params": [
    {
      "eventid": "632",
      "scriptid": "4",
      "manualinput": "dashboard.view"
    }
  ],
  "id": 1
}

```

Response:

```

{
  "jsonrpc": "2.0",
  "result": {
    "632": [
      {
        "scriptid": "4",
        "name": "Open Zabbix page",
        "command": "",
        "host_access": "2",
        "usrgrp": "0",

```

```

        "groupid": "0",
        "description": "",
        "confirmation": "Are you sure you want to open page dashboard.view?",
        "type": "6",
        "execute_on": "2",
        "timeout": "30s",
        "scope": "4",
        "port": "",
        "authtype": "0",
        "username": "",
        "password": "",
        "publickey": "",
        "privatekey": "",
        "menu_path": "",
        "url": "http://localhost/ui/zabbix.php?action=dashboard.view",
        "new_window": "1",
        "manualinput": "1",
        "manualinput_prompt": "Zabbix page to open:",
        "manualinput_validator_type": "1",
        "manualinput_validator": "dashboard.view,discovery.view",
        "manualinput_default_value": "",
        "parameters": []
    }
]
},
    "id": 1
}

```

Source

CScript::getScriptsByEvents() in `ui/include/classes/api/services/CScript.php`.

script.getscriptsbyhosts

Description

object script.getscriptsbyhosts(object parameters)

This method allows to retrieve all available scripts on the given host or specific script if script ID is provided. When manualinput is provided, it substitutes the {MANUALINPUT} macro with the specified value.

Note:

This method is available to users of any type. Permissions to call the method can be revoked in user role settings. See [User roles](#) for more information.

Parameters

(object/array) The method accepts object or array of objects with the following parameters.

Parameter	Type	Description
hostid	ID	ID of host to return scripts for. Must be unique.
scriptid	ID	ID of script to return.
manualinput	string	Value of the user-provided {MANUALINPUT} macro value.

Parameter behavior:
- *required*

Return values

(object) Returns an object with host IDs as properties and arrays of available scripts as values. If script ID is provided, the associated value is an array containing the specific script.

Note:

The method will automatically expand macros in the confirmation text, manualinput prompt text and url. If the manualinput parameter is provided, the {MANUALINPUT} macro will be resolved to the specified value.

Examples

Retrieve scripts by host IDs

Retrieve all scripts available on hosts "30079" and "30073".

Request:

```
{
  "jsonrpc": "2.0",
  "method": "script.getscriptsbyhosts",
  "params": [
    {
      "hostid": "30079"
    },
    {
      "hostid": "30073"
    }
  ],
  "id": 1
}
```

Response:

```
{
  "jsonrpc": "2.0",
  "result": {
    "30079": [
      {
        "scriptid": "3",
        "name": "Detect operating system",
        "command": "sudo /usr/bin/nmap -O {HOST.CONN} 2>&1",
        "host_access": "2",
        "usrgrpuid": "7",
        "groupid": "0",
        "description": "",
        "confirmation": "",
        "type": "0",
        "execute_on": "1",
        "timeout": "30s",
        "scope": "2",
        "port": "",
        "authtype": "0",
        "username": "",
        "password": "",
        "publickey": "",
        "privatekey": "",
        "menu_path": "",
        "url": "",
        "new_window": "1",
        "manualinput": "0",
        "manualinput_prompt": "",
        "manualinput_validator_type": "0",
        "manualinput_validator": "",
        "manualinput_default_value": "",
        "parameters": []
      },
      {
        "scriptid": "1",
        "name": "Ping",
        "command": "/bin/ping -c 3 {HOST.CONN} 2>&1",

```

```

    "host_access": "2",
    "usrgrpuid": "0",
    "groupid": "0",
    "description": "",
    "confirmation": "",
    "type": "0",
    "execute_on": "1",
    "timeout": "30s",
    "scope": "2",
    "port": "",
    "authtype": "0",
    "username": "",
    "password": "",
    "publickey": "",
    "privatekey": "",
    "menu_path": "",
    "url": "",
    "new_window": "1",
    "manualinput": "0",
    "manualinput_prompt": "",
    "manualinput_validator_type": "0",
    "manualinput_validator": "",
    "manualinput_default_value": "",
    "parameters": []
},
{
    "scriptid": "4",
    "name": "Open Zabbix page",
    "command": "",
    "host_access": "2",
    "usrgrpuid": "0",
    "groupid": "0",
    "description": "",
    "confirmation": "Are you sure you want to open page *UNKNOWN*?",
    "type": "6",
    "execute_on": "2",
    "timeout": "30s",
    "scope": "2",
    "port": "",
    "authtype": "0",
    "username": "",
    "password": "",
    "publickey": "",
    "privatekey": "",
    "menu_path": "",
    "url": "http://localhost/ui/zabbix.php?action=*UNKNOWN*",
    "new_window": "1",
    "manualinput": "0",
    "manualinput_prompt": "Zabbix page to open:",
    "manualinput_validator_type": "0",
    "manualinput_validator": "dashboard.view,discovery.view",
    "manualinput_default_value": "",
    "parameters": []
},
{
    "scriptid": "2",
    "name": "Traceroute",
    "command": "/usr/bin/traceroute {HOST.CONN} 2>&1",
    "host_access": "2",
    "usrgrpuid": "0",
    "groupid": "0",
    "description": "",

```

```

        "confirmation": "",
        "type": "0",
        "execute_on": "1",
        "timeout": "30s",
        "scope": "2",
        "port": "",
        "authtype": "0",
        "username": "",
        "password": "",
        "publickey": "",
        "privatekey": "",
        "menu_path": "",
        "url": "",
        "new_window": "1",
        "manualinput": "0",
        "manualinput_prompt": "",
        "manualinput_validator_type": "0",
        "manualinput_validator": "",
        "manualinput_default_value": "",
        "parameters": []
    }
],
"30073": [
    {
        "scriptid": "3",
        "name": "Detect operating system",
        "command": "sudo /usr/bin/nmap -O {HOST.CONN} 2>&1",
        "host_access": "2",
        "usrgrpuid": "7",
        "groupid": "0",
        "description": "",
        "confirmation": "",
        "type": "0",
        "execute_on": "1",
        "timeout": "30s",
        "scope": "2",
        "port": "",
        "authtype": "0",
        "username": "",
        "password": "",
        "publickey": "",
        "privatekey": "",
        "menu_path": "",
        "url": "",
        "new_window": "1",
        "manualinput": "0",
        "manualinput_prompt": "",
        "manualinput_validator_type": "0",
        "manualinput_validator": "",
        "manualinput_default_value": "",
        "parameters": []
    },
    {
        "scriptid": "1",
        "name": "Ping",
        "command": "/bin/ping -c 3 {HOST.CONN} 2>&1",
        "host_access": "2",
        "usrgrpuid": "0",
        "groupid": "0",
        "description": "",
        "confirmation": "",
        "type": "0",

```

```

    "execute_on": "1",
    "timeout": "30s",
    "scope": "2",
    "port": "",
    "authtype": "0",
    "username": "",
    "password": "",
    "publickey": "",
    "privatekey": "",
    "menu_path": "",
    "url": "",
    "new_window": "1",
    "manualinput": "0",
    "manualinput_prompt": "",
    "manualinput_validator_type": "0",
    "manualinput_validator": "",
    "manualinput_default_value": "",
    "parameters": []
  },
  {
    "scriptid": "4",
    "name": "Open Zabbix page",
    "command": "",
    "host_access": "2",
    "usrgrp": "0",
    "groupid": "0",
    "description": "",
    "confirmation": "Are you sure you want to open page *UNKNOWN*?",
    "type": "6",
    "execute_on": "2",
    "timeout": "30s",
    "scope": "2",
    "port": "",
    "authtype": "0",
    "username": "",
    "password": "",
    "publickey": "",
    "privatekey": "",
    "menu_path": "",
    "url": "http://localhost/ui/zabbix.php?action=*UNKNOWN*",
    "new_window": "1",
    "manualinput": "1",
    "manualinput_prompt": "Zabbix page to open:",
    "manualinput_validator_type": "1",
    "manualinput_validator": "dashboard.view,discovery.view",
    "manualinput_default_value": "",
    "parameters": []
  },
  {
    "scriptid": "2",
    "name": "Traceroute",
    "command": "/usr/bin/traceroute {HOST.CONN} 2>&1",
    "host_access": "2",
    "usrgrp": "0",
    "groupid": "0",
    "description": "",
    "confirmation": "",
    "type": "0",
    "execute_on": "1",
    "timeout": "30s",
    "scope": "2",
    "port": "",

```

```

        "authtype": "0",
        "username": "",
        "password": "",
        "publickey": "",
        "privatekey": "",
        "menu_path": "",
        "url": "",
        "new_window": "1",
        "manualinput": "0",
        "manualinput_prompt": "",
        "manualinput_validator_type": "0",
        "manualinput_validator": "",
        "manualinput_default_value": "",
        "parameters": []
    }
]
},
"id": 1
}

```

Retrieve specific script with manualinput value.

Retrieve script with ID "4" on host "30079" with manualinput value "dashboard.view".

Request:

```

{
  "jsonrpc": "2.0",
  "method": "script.getscriptsbyhosts",
  "params": [
    {
      "hostid": "30079",
      "scriptid": "4",
      "manualinput": "dashboard.view"
    }
  ],
  "id": 1
}

```

Response:

```

{
  "jsonrpc": "2.0",
  "result": {
    "30079": [
      {
        "scriptid": "4",
        "name": "Open Zabbix page",
        "command": "",
        "host_access": "2",
        "usrgrp": "0",
        "groupid": "0",
        "description": "",
        "confirmation": "Are you sure you want to open page dashboard.view?",
        "type": "6",
        "execute_on": "2",
        "timeout": "30s",
        "scope": "2",
        "port": "",
        "authtype": "0",
        "username": "",
        "password": "",
        "publickey": "",
        "privatekey": "",
        "menu_path": "",

```

```

        "url": "http://localhost/ui/zabbix.php?action=dashboard.view",
        "new_window": "1",
        "manualinput": "1",
        "manualinput_prompt": "Zabbix page to open:",
        "manualinput_validator_type": "1",
        "manualinput_validator": "dashboard.view,discovery.view",
        "manualinput_default_value": "",
        "parameters": []
    }
]
},
"id": 1
}

```

Source

CScript::getScriptsByHosts() in `ui/include/classes/api/services/CScript.php`.

script.update

Description

object script.update(object/array scripts)

This method allows to update existing scripts.

Note:

This method is only available to *Super admin* user type. Permissions to call the method can be revoked in user role settings. See [User roles](#) for more information.

Parameters

(object/array) **Script properties** to be updated.

The `scriptid` property must be defined for each script, all other properties are optional. Only the passed properties will be updated, all others will remain unchanged. An exception is type property change from 5 (Webhook) to other: the `parameters` property will be cleaned.

Return values

(object) Returns an object containing the IDs of the updated scripts under the `scriptids` property.

Examples

Change script command

Change the command of the script to `"/bin/ping -c 10 {HOST.CONN} 2>&1"`.

Request:

```

{
  "jsonrpc": "2.0",
  "method": "script.update",
  "params": {
    "scriptid": "1",
    "command": "/bin/ping -c 10 {HOST.CONN} 2>&1"
  },
  "id": 1
}

```

Response:

```

{
  "jsonrpc": "2.0",
  "result": {
    "scriptids": [
      "1"
    ]
  },
}

```



```
"id": 1
}
```

Change script command and add manual input

Change the command of the script to `"/bin/ping -c {MANUALINPUT} {HOST.CONN} 2>&1"`.

Request:

```
{
  "jsonrpc": "2.0",
  "method": "script.update",
  "params": {
    "scriptid": "1",
    "command": "/bin/ping -c {MANUALINPUT} {HOST.CONN} 2>&1",
    "manualinput": "1",
    "manualinput_prompt": "Specify the number of ICMP packets to send with the ping command",
    "manualinput_validator": "^(?:[1-9]|10)$",
    "manualinput_validator_type": "0",
    "manualinput_default_value": "10"
  },
  "id": 1
}
```

Response:

```
{
  "jsonrpc": "2.0",
  "result": {
    "scriptids": [
      "1"
    ]
  },
  "id": 1
}
```

Source

`CScript::update()` in `ui/include/classes/api/services/CScript.php`.

Service

This class is designed to work with IT infrastructure/business services.

Object references:

- [Service](#)
- [Status rule](#)
- [Service tag](#)
- [Service alarm](#)
- [Problem tag](#)

Available methods:

- `service.create` - create new services
- `service.delete` - delete services
- `service.get` - retrieve services
- `service.update` - update services

Service object

The following objects are directly related to the service API.

Service

The service object has the following properties.

Property	Type	Description
serviceid	ID	ID of the service.
algorithm	integer	<p>Property behavior: - <i>read-only</i> - <i>required</i> for update operations Status calculation rule. Only applicable if child services exist.</p> <p>Possible values: 0 - set status to OK; 1 - most critical if all children have problems; 2 - most critical of child services.</p> <p>Property behavior: - <i>required</i> for create operations Name of the service.</p>
name	string	<p>Property behavior: - <i>required</i> for create operations Name of the service.</p>
sortorder	integer	<p>Property behavior: - <i>required</i> for create operations Position of the service used for sorting.</p> <p>Possible values: 0-999.</p> <p>Property behavior: - <i>required</i> for create operations Service weight.</p>
weight	integer	<p>Possible values: 0-1000000.</p>
propagation_rule	integer	<p>Default: 0. Status propagation rule.</p> <p>Possible values: 0 - (<i>default</i>) propagate service status as is - without any changes; 1 - increase the propagated status by a given <code>propagation_value</code> (by 1 to 5 severities); 2 - decrease the propagated status by a given <code>propagation_value</code> (by 1 to 5 severities); 3 - ignore this service - the status is not propagated to the parent service at all; 4 - set fixed service status using a given <code>propagation_value</code>.</p> <p>Property behavior: - <i>required</i> if <code>propagation_value</code> is set</p>

Property	Type	Description
propagation_value	integer	<p>Status propagation value.</p> <p>Possible values if propagation_rule is set to "0" or "3": 0 - Not classified.</p> <p>Possible values if propagation_rule is set to "1" or "2": 1 - Information; 2 - Warning; 3 - Average; 4 - High; 5 - Disaster.</p> <p>Possible values if propagation_rule is set to "4": -1 - OK; 0 - Not classified; 1 - Information; 2 - Warning; 3 - Average; 4 - High; 5 - Disaster.</p>
status	integer	<p>Property behavior: - <i>required</i> if propagation_rule is set</p> <p>Whether the service is in OK or problem state.</p> <p>If the service is in problem state, status is equal either to: - the severity of the most critical problem; - the highest status of a child service in problem state.</p> <p>If the service is in OK state, status is equal to: -1.</p>
description	string	<p>Property behavior: - <i>read-only</i></p> <p>Description of the service.</p>
uuid	string	<p>Universal unique identifier, used for linking imported services to already existing ones. Auto-generated, if not given.</p>
created_at	integer	<p>Unix timestamp when service was created.</p>
readonly	boolean	<p>Access to the service.</p> <p>Possible values: 0 - Read-write; 1 - Read-only.</p> <p>Property behavior: - <i>read-only</i></p>

Status rule

The status rule object has the following properties.

Property	Type	Description
type	integer	<p>Condition for setting (New status) status.</p> <p>Possible values:</p> <ul style="list-style-type: none"> 0 - if at least (N) child services have (Status) status or above; 1 - if at least (N%) of child services have (Status) status or above; 2 - if less than (N) child services have (Status) status or below; 3 - if less than (N%) of child services have (Status) status or below; 4 - if weight of child services with (Status) status or above is at least (W); 5 - if weight of child services with (Status) status or above is at least (N%); 6 - if weight of child services with (Status) status or below is less than (W); 7 - if weight of child services with (Status) status or below is less than (N%). <p>Where:</p> <ul style="list-style-type: none"> - N (W) is <code>limit_value</code>; - (Status) is <code>limit_status</code>; - (New status) is <code>new_status</code>. <p>Property behavior:</p> <ul style="list-style-type: none"> - <i>required</i>
limit_value	integer	<p>Limit value.</p> <p>Possible values:</p> <ul style="list-style-type: none"> - for N and W: 1-100000; - for N%: 1-100. <p>Property behavior:</p> <ul style="list-style-type: none"> - <i>required</i>
limit_status	integer	<p>Limit status.</p> <p>Possible values:</p> <ul style="list-style-type: none"> -1 - OK; 0 - Not classified; 1 - Information; 2 - Warning; 3 - Average; 4 - High; 5 - Disaster. <p>Property behavior:</p> <ul style="list-style-type: none"> - <i>required</i>
new_status	integer	<p>New status value.</p> <p>Possible values:</p> <ul style="list-style-type: none"> 0 - Not classified; 1 - Information; 2 - Warning; 3 - Average; 4 - High; 5 - Disaster. <p>Property behavior:</p> <ul style="list-style-type: none"> - <i>required</i>

Service tag

The service tag object has the following properties.

Property	Type	Description
tag	string	Service tag name. Property behavior: - <i>required</i>
value	string	Service tag value.

Service alarm

Note:

Service alarms cannot be directly created, updated or deleted via the Zabbix API.

The service alarm objects represent a service's state change. It has the following properties.

Property	Type	Description
clock	timestamp	Time when the service state change has happened.
value	integer	Status of the service.

Refer to the **service status property** for a list of possible values.

Problem tag

Problem tags allow linking services with problem events. The problem tag object has the following properties.

Property	Type	Description
tag	string	Problem tag name.
operator	integer	Property behavior: - <i>required</i> Mapping condition operator.
value	string	Possible values: 0 - (<i>default</i>) equals; 2 - like. Problem tag value.

service.create

Description

object `service.create(object/array services)`

This method allows to create new services.

Note:

This method is available to users of any type. Permissions to call the method can be revoked in user role settings. See **User roles** for more information.

Parameters

(object/array) services to create.

Additionally to the **standard service properties**, the method accepts the following parameters.

Parameter	Type	Description
children	array	Child services to be linked to the service.
parents	array	The child services must have only the <code>serviceid</code> property defined. Parent services to be linked to the service.

The parent services must have only the `serviceid` property defined.

Parameter	Type	Description
tags	array	Service tags to be created for the service.
problem_tags	array	Problem tags to be created for the service.
status_rules	array	Status rules to be created for the service.

Return values

(object) Returns an object containing the IDs of the created services under the `serviceids` property. The order of the returned IDs matches the order of the passed services.

Examples

Creating a service

Create a service that will be switched to problem state, if at least one child has a problem.

Request:

```
{
  "jsonrpc": "2.0",
  "method": "service.create",
  "params": {
    "name": "Server 1",
    "algorithm": 1,
    "sortorder": 1
  },
  "id": 1
}
```

Response:

```
{
  "jsonrpc": "2.0",
  "result": {
    "serviceids": [
      "5"
    ]
  },
  "id": 1
}
```

Source

CService::create() in `ui/include/classes/api/services/CService.php`.

service.delete

Description

object `service.delete(array serviceIds)`

This method allows to delete services.

Note:

This method is available to users of any type. Permissions to call the method can be revoked in user role settings. See [User roles](#) for more information.

Parameters

(array) IDs of the services to delete.

Return values

(object) Returns an object containing the IDs of the deleted services under the `serviceids` property.

Examples

Deleting multiple services

Delete two services.

Request:

```
{
  "jsonrpc": "2.0",
  "method": "service.delete",
  "params": [
    "4",
    "5"
  ],
  "id": 1
}
```

Response:

```
{
  "jsonrpc": "2.0",
  "result": {
    "serviceids": [
      "4",
      "5"
    ]
  },
  "id": 1
}
```

Source

CService::delete() in *ui/include/classes/api/services/CService.php*.

service.get

Description

integer/array service.get(object parameters)

The method allows to retrieve services according to the given parameters.

Note:

This method is available to users of any type. Permissions to call the method can be revoked in user role settings. See [User roles](#) for more information.

Parameters

(object) Parameters defining the desired output.

The method supports the following parameters.

Parameter	Type	Description
serviceids	ID/array	Return only services with the given IDs.
parentids	ID/array	Return only services that are linked to the given parent services.
deep_parentids	flag	Return all direct and indirect child services. Used together with <code>parentids</code> .
childids	ID/array	Return only services that are linked to the given child services.
evaltype	integer	Rules for tag searching. Possible values: 0 - (default) And/Or; 2 - Or.

Parameter	Type	Description
tags	object/array	<p>Return only services with given tags. Exact match by tag and case-sensitive or case-insensitive search by tag value depending on operator value.</p> <p>Format: [{"tag": "<tag>", "value": "<value>", "operator": "<operator>"}, ...].</p> <p>An empty array returns all services.</p> <p>Possible operator values:</p> <ul style="list-style-type: none"> 0 - (default) Contains; 1 - Equals; 2 - Does not contain; 3 - Does not equal; 4 - Exists; 5 - Does not exist.
problem_tags	object/array	<p>Return only services with given problem tags. Exact match by tag and case-sensitive or case-insensitive search by tag value depending on operator value.</p> <p>Format: [{"tag": "<tag>", "value": "<value>", "operator": "<operator>"}, ...].</p> <p>An empty array returns all services.</p> <p>Possible operator values:</p> <ul style="list-style-type: none"> 0 - (default) Contains; 1 - Equals; 2 - Does not contain; 3 - Does not equal; 4 - Exists; 5 - Does not exist.
without_problem_tags	flag	Return only services without problem tags.
slaid	ID/array	Return only services that are linked to the specific SLA(s).
selectChildren	query	Return a children property with the child services.
selectParents	query	<p>Supports count.</p> <p>Return a parents property with the parent services.</p>
selectTags	query	<p>Supports count.</p> <p>Return a tags property with service tags.</p>
selectProblemEvents	query	<p>Supports count.</p> <p>Return a problem_events property with an array of problem event objects.</p> <p>The problem event object has the following properties:</p> <ul style="list-style-type: none"> eventid - (ID) Event ID; severity - (string) Current event severity; name - (string) Resolved event name.
selectProblemTags	query	<p>Supports count.</p> <p>Return a problem_tags property with problem tags.</p>
selectStatusRules	query	<p>Supports count.</p> <p>Return a status_rules property with status rules.</p> <p>Supports count.</p>

Parameter	Type	Description
selectStatusTimeline	object/array	Return a <code>status_timeline</code> property containing service state changes for given periods. Format [{"period_from": "<period_from>", "period_to": "<period_to>"}, ...] - <code>period_from</code> being a starting date (inclusive; integer timestamp) and <code>period_to</code> being an ending date (exclusive; integer timestamp) for the period you're interested in. Returns an array of entries containing a <code>start_value</code> property and an <code>alarms</code> array for the state changes within specified periods.
sortfield	string/array	Sort the result by the given properties. Possible values: <code>serviceid</code> , <code>name</code> , <code>status</code> , <code>sortorder</code> , <code>created_at</code> .
countOutput	boolean	These parameters being common for all get methods are described in detail in the reference commentary .
editable	boolean	
excludeSearch	boolean	
filter	object	
limit	integer	
output	query	
preservekeys	boolean	
search	object	
searchByAny	boolean	
searchWildcardsEnabled	boolean	
sortorder	string/array	
startSearch	boolean	

Return values

(integer/array) Returns either:

- an array of objects;
- the count of retrieved objects, if the `countOutput` parameter has been used.

Examples

Retrieving all services

Retrieve all data about all services and their dependencies.

Request:

```
{
  "jsonrpc": "2.0",
  "method": "service.get",
  "params": {
    "output": "extend",
    "selectChildren": "extend",
    "selectParents": "extend"
  },
  "id": 1
}
```

Response:

```
{
  "jsonrpc": "2.0",
  "result": [
    {
      "serviceid": "1",
      "name": "My Service - 0001",
      "status": "-1",
      "algorithm": "2",
      "sortorder": "0",

```

```

        "weight": "0",
        "propagation_rule": "0",
        "propagation_value": "0",
        "description": "My Service Description 0001.",
        "uuid": "dfa4daeaea754e3a95c04d6029182681",
        "created_at": "946684800",
        "readonly": false,
        "parents": [],
        "children": []
    },
    {
        "serviceid": "2",
        "name": "My Service - 0002",
        "status": "-1",
        "algorithm": "2",
        "sortorder": "0",
        "weight": "0",
        "propagation_rule": "0",
        "propagation_value": "0",
        "description": "My Service Description 0002.",
        "uuid": "20ea0d85212841219130abeaca28c065",
        "created_at": "946684800",
        "readonly": false,
        "parents": [],
        "children": []
    }
],
    "id": 1
}

```

Source

CService::get() in *ui/include/classes/api/services/CService.php*.

service.update

Description

object service.update(object/array services)

This method allows to update existing services.

Note:

This method is available to users of any type. Permissions to call the method can be revoked in user role settings. See [User roles](#) for more information.

Parameters

(object/array) service properties to be updated.

The `serviceid` property must be defined for each service, all other properties are optional. Only the passed properties will be updated, all others will remain unchanged.

Additionally to the [standard service properties](#), the method accepts the following parameters.

Parameter	Type	Description
children	array	Child services to replace the current child services.
parents	array	The child services must have only the <code>serviceid</code> property defined. Parent services to replace the current parent services.
tags	array	The parent services must have only the <code>serviceid</code> property defined. Service tags to replace the current service tags.
problem_tags	array	Problem tags to replace the current problem tags.

Parameter	Type	Description
status_rules	array	Status rules to replace the current status rules.

Return values

(object) Returns an object containing the IDs of the updated services under the serviceids property.

Examples

Setting the parent for a service

Make service with ID "3" to be the parent for service with ID "5".

Request:

```
{
  "jsonrpc": "2.0",
  "method": "service.update",
  "params": {
    "serviceid": "5",
    "parents": [
      {
        "serviceid": "3"
      }
    ]
  },
  "id": 1
}
```

Response:

```
{
  "jsonrpc": "2.0",
  "result": {
    "serviceids": [
      "5"
    ]
  },
  "id": 1
}
```

Adding a scheduled downtime

Add a downtime for service with ID "4" scheduled weekly from Monday 22:00 till Tuesday 10:00.

Request:

```
{
  "jsonrpc": "2.0",
  "method": "service.update",
  "params": {
    "serviceid": "4",
    "times": [
      {
        "type": "1",
        "ts_from": "165600",
        "ts_to": "201600"
      }
    ]
  },
  "id": 1
}
```

Response:

```
{
  "jsonrpc": "2.0",
  "result": {
```

```

        "serviceids": [
            "4"
        ],
        "id": 1
    }
}

```

Source

CService::update() in *ui/include/classes/api/services/CService.php*.

Settings

This class is designed to work with common administration settings.

Object references:

- [Settings](#)

Available methods:

- `settings.get` - retrieve settings
- `settings.update` - update settings

Settings object

The following objects are directly related to the settings API.

Settings

The settings object has the following properties.

Property	Type	Description
default_lang	string	System language by default.
default_timezone	string	Default: en_US. System time zone by default. Default: system - system default.
default_theme	string	For the full list of supported time zones please refer to PHP documentation . Default theme.
search_limit	integer	Possible values: blue-theme - (default) Blue; dark-theme - Dark; hc-light - High-contrast light; hc-dark - High-contrast dark. Limit for search and filter results.
max_overview_table_size	integer	Default: 1000. Max number of columns and rows in Data overview and Trigger overview dashboard widgets.
max_in_table	integer	Default: 50. Max count of elements to show inside table cell.
server_check_interval	integer	Default: 50. Show warning if Zabbix server is down.
		Possible values: 0 - Do not show warning; 10 - (default) Show warning.

Property	Type	Description
work_period	string	Working time. Default: 1-5,09:00-18:00.
show_technical_errors	integer	Show technical errors (PHP/SQL) to non-Super admin users and to users that are not part of user groups with debug mode enabled. Possible values: 0 - <i>(default)</i> Do not technical errors; 1 - Show technical errors.
history_period	string	Max period to display history data in Latest data, Web, and Data overview dashboard widgets. Accepts seconds and time unit with suffix.
period_default	string	Default: 24h. Time filter default period. Accepts seconds and time unit with suffix with month and year support (30s, 1m, 2h, 1d, 1M, 1y).
max_period	string	Default: 1h. Max period for time filter. Accepts seconds and time unit with suffix with month and year support (30s, 1m, 2h, 1d, 1M, 1y).
severity_color_0	string	Default: 2y. Color for "Not classified" severity as a hexadecimal color code.
severity_color_1	string	Default: 97AAB3. Color for "Information" severity as a hexadecimal color code.
severity_color_2	string	Default: 7499FF. Color for "Warning" severity as a hexadecimal color code.
severity_color_3	string	Default: FFC859. Color for "Average" severity as a hexadecimal color code.
severity_color_4	string	Default: FFA059. Color for "High" severity as a hexadecimal color code.
severity_color_5	string	Default: E97659. Color for "Disaster" severity as a hexadecimal color code.
severity_name_0	string	Default: E45959. Name for "Not classified" severity.
severity_name_1	string	Default: Not classified. Name for "Information" severity.
severity_name_2	string	Default: Information. Name for "Warning" severity.
severity_name_3	string	Default: Warning. Name for "Average" severity.
severity_name_4	string	Default: Average. Name for "High" severity.
severity_name_5	string	Default: High. Name for "Disaster" severity. Default: Disaster.

Property	Type	Description
custom_color	integer	Use custom event status colors. Possible values: 0 - (<i>default</i>) Do not use custom event status colors; 1 - Use custom event status colors.
ok_period	string	Display OK triggers period. Accepts seconds and time unit with suffix. Default: 5m.
blink_period	string	On status change triggers blink period. Accepts seconds and time unit with suffix.
problem_unack_color	string	Default: 2m. Color for unacknowledged PROBLEM events as a hexadecimal color code.
problem_ack_color	string	Default: CC0000. Color for acknowledged PROBLEM events as a hexadecimal color code.
ok_unack_color	string	Default: CC0000. Color for unacknowledged RESOLVED events as a hexadecimal color code.
ok_ack_color	string	Default: 009900. Color for acknowledged RESOLVED events as a hexadecimal color code.
problem_unack_style	integer	Default: 009900. Blinking for unacknowledged PROBLEM events. Possible values: 0 - Do not show blinking; 1 - (<i>default</i>) Show blinking.
problem_ack_style	integer	Blinking for acknowledged PROBLEM events. Possible values: 0 - Do not show blinking; 1 - (<i>default</i>) Show blinking.
ok_unack_style	integer	Blinking for unacknowledged RESOLVED events. Possible values: 0 - Do not show blinking; 1 - (<i>default</i>) Show blinking.
ok_ack_style	integer	Blinking for acknowledged RESOLVED events. Possible values: 0 - Do not show blinking; 1 - (<i>default</i>) Show blinking.
url	string	Frontend URL.
discovery_groupid	ID	ID of the host group to which will be automatically placed discovered hosts.
default_inventory_mode	integer	Default host inventory mode. Possible values: -1 - (<i>default</i>) Disabled; 0 - Manual; 1 - Automatic.
alert_usrgrpid	ID	ID of the user group to which will be sending database down alarm message. If set to "0", the alarm message will not be sent.

Property	Type	Description
snmptrap_logging	integer	Log unmatched SNMP traps. Possible values: 0 - Do not log unmatched SNMP traps; 1 - (<i>default</i>) Log unmatched SNMP traps.
login_attempts	integer	Number of failed login attempts after which login form will be blocked. Default: 5.
login_block	string	Time interval during which login form will be blocked if number of failed login attempts exceeds defined in login_attempts field. Accepts seconds and time unit with suffix. Default: 30s.
validate_uri_schemes	integer	Validate URI schemes. Possible values: 0 - Do not validate; 1 - (<i>default</i>) Validate.
uri_valid_schemes	string	Valid URI schemes. Default: http,https,ftp,file,mailto,tel,ssh.
x_frame_options	string	X-Frame-Options HTTP header. Default: SAMEORIGIN.
iframe_sandboxing_enabled	integer	Use iframe sandboxing. Possible values: 0 - Do not use; 1 - (<i>default</i>) Use.
iframe_sandboxing_exceptions	string	Iframe sandboxing exceptions.
connect_timeout	string	Connection timeout with Zabbix server. Possible values range: 1-30s. Default: 3s.
socket_timeout	string	Network default timeout. Possible values range: 1-300s. Default: 3s. Property behavior: - <i>required</i>
media_type_test_timeout	string	Network timeout for media type test. Possible values range: 1-300s. Default: 65s. Property behavior: - <i>required</i>
item_test_timeout	string	Network timeout for item tests. Possible value range: 1-600s. Default: 60s. Property behavior: - <i>required</i>

Property	Type	Description
script_timeout	string	Network timeout for script execution. Possible values range: 1-300s. Default: 60s.
report_test_timeout	string	Property behavior: - <i>required</i> Network timeout for scheduled report test. Possible values range: 1-300s. Default: 60s.
auditlog_enabled	integer	Property behavior: - <i>required</i> Whether to enable audit logging. Possible values: 0 - Disable; 1 - (<i>default</i>) Enable.
auditlog_mode	integer	Whether to enable audit logging of low-level discovery, network discovery and autoregistration activities performed by the server (System user). Possible values: 0 - Disable; 1 - (<i>default</i>) Enable.
ha_failover_delay	string	Failover delay in seconds. Default: 1m.
geomaps_tile_provider	string	Property behavior: - <i>read-only</i> Geomap tile provider. Possible values: OpenStreetMap.Mapnik - (<i>default</i>) OpenStreetMap Mapnik; OpenTopoMap - OpenTopoMap; Stamen.TonerLite - Stamen Toner Lite; Stamen.Terrain - Stamen Terrain; USGS.USTopo - USGS US Topo; USGS.USImagery - USGS US Imagery.
geomaps_tile_url	string	Supports empty string to specify custom values of geomaps_tile_url, geomaps_max_zoom and geomaps_attribution. Geomap tile URL.
geomaps_max_zoom	integer	Property behavior: - <i>supported</i> if geomaps_tile_provider is set to empty string Geomap max zoom level. Possible values: 0-30.
geomaps_attribution	string	Property behavior: - <i>supported</i> if geomaps_tile_provider is set to empty string Geomap attribution text. Property behavior: - <i>supported</i> if geomaps_tile_provider is set to empty string

Property	Type	Description
vault_provider	integer	Vault provider. Possible values: 0 - (<i>default</i>) HashiCorp Vault; 1 - CyberArk Vault.
timeout_zabbix_agent	string	Spend no more than <code>timeout_*</code> seconds on processing. Accepts seconds or time unit with suffix (e.g., 30s, 1m). Also accepts user macros. Possible values range: 1-600s. Default: 3s. Default for <code>timeout_browser</code> : 60s. Property behavior: - <i>required</i>
timeout_simple_check		
timeout_snmp_agent		
timeout_external_check		
timeout_db_monitor		
timeout_http_agent		
timeout_ssh_agent		
timeout_telnet_agent		
timeout_script		
timeout_browser		

settings.get

Description

object settings.get(object parameters)

The method allows to retrieve settings object according to the given parameters.

Note:

This method is available to users of any type. Permissions to call the method can be revoked in user role settings. See [User roles](#) for more information.

Parameters

(object) Parameters defining the desired output.

The method supports only one parameter.

Parameter	Type	Description
output	query	This parameter being common for all get methods described in the reference commentary .

Return values

(object) Returns settings object.

Examples

Request:

```
{
  "jsonrpc": "2.0",
  "method": "settings.get",
  "params": {
    "output": "extend"
  },
}
```

```
"id": 1
}
```

Response:

```
{
  "jsonrpc": "2.0",
  "result": {
    "default_theme": "blue-theme",
    "search_limit": "1000",
    "max_in_table": "50",
    "server_check_interval": "10",
    "work_period": "1-5,09:00-18:00",
    "show_technical_errors": "0",
    "history_period": "24h",
    "period_default": "1h",
    "max_period": "2y",
    "severity_color_0": "97AAB3",
    "severity_color_1": "7499FF",
    "severity_color_2": "FFC859",
    "severity_color_3": "FFA059",
    "severity_color_4": "E97659",
    "severity_color_5": "E45959",
    "severity_name_0": "Not classified",
    "severity_name_1": "Information",
    "severity_name_2": "Warning",
    "severity_name_3": "Average",
    "severity_name_4": "High",
    "severity_name_5": "Disaster",
    "custom_color": "0",
    "ok_period": "5m",
    "blink_period": "2m",
    "problem_unack_color": "CC0000",
    "problem_ack_color": "CC0000",
    "ok_unack_color": "009900",
    "ok_ack_color": "009900",
    "problem_unack_style": "1",
    "problem_ack_style": "1",
    "ok_unack_style": "1",
    "ok_ack_style": "1",
    "discovery_groupid": "5",
    "default_inventory_mode": "-1",
    "alert_usrgrpid": "7",
    "snmptrap_logging": "1",
    "default_lang": "en_US",
    "default_timezone": "system",
    "login_attempts": "5",
    "login_block": "30s",
    "validate_uri_schemes": "1",
    "uri_valid_schemes": "http,https,ftp,file,mailto,tel,ssh",
    "x_frame_options": "SAMEORIGIN",
    "iframe_sandboxing_enabled": "1",
    "iframe_sandboxing_exceptions": "",
    "max_overview_table_size": "50",
    "connect_timeout": "3s",
    "socket_timeout": "3s",
    "media_type_test_timeout": "65s",
    "script_timeout": "60s",
    "item_test_timeout": "60s",
    "url": "",
    "report_test_timeout": "60s",
    "auditlog_enabled": "1",
    "auditlog_mode": "1",
  }
}
```

```

    "ha_failover_delay": "1m",
    "geomaps_tile_provider": "OpenStreetMap.Mapnik",
    "geomaps_tile_url": "",
    "geomaps_max_zoom": "0",
    "geomaps_attribution": "",
    "vault_provider": "0",
    "timeout_zabbix_agent": "3s",
    "timeout_simple_check": "3s",
    "timeout_snmp_agent": "3s",
    "timeout_external_check": "3s",
    "timeout_db_monitor": "3s",
    "timeout_http_agent": "3s",
    "timeout_ssh_agent": "3s",
    "timeout_telnet_agent": "3s",
    "timeout_script": "3s"
  },
  "id": 1
}

```

Source

CSettings::get() in `ui/include/classes/api/services/CSettings.php`.

settings.update

Description

object settings.update(object settings)

This method allows to update existing common settings.

Note:

This method is only available to *Super admin* user type. Permissions to call the method can be revoked in user role settings. See [User roles](#) for more information.

Parameters

(object) **Settings properties** to be updated.

Return values

(array) Returns an array with the names of updated parameters.

Examples

Request:

```

{
  "jsonrpc": "2.0",
  "method": "settings.update",
  "params": {
    "login_attempts": "1",
    "login_block": "1m"
  },
  "id": 1
}

```

Response:

```

{
  "jsonrpc": "2.0",
  "result": [
    "login_attempts",
    "login_block"
  ],
  "id": 1
}

```

Source

CSettings::update() in *ui/include/classes/api/services/CSettings.php*.

SLA

This class is designed to work with SLA (Service Level Agreement) objects used to estimate the performance of IT infrastructure and business services.

Object references:

- [SLA](#)
- [SLA schedule](#)
- [SLA excluded downtime](#)
- [SLA service tag](#)

Available methods:

- [sla.create](#) - create new SLAs
- [sla.delete](#) - delete SLAs
- [sla.get](#) - retrieve SLAs
- [sla.getsli](#) - retrieve Service Level Indicator (SLI) data for SLAs
- [sla.update](#) - update SLAs

SLA object

The following objects are directly related to the `s1a` (Service Level Agreement) API.

SLA

The SLA object has the following properties.

Property	Type	Description
slaid	ID	ID of the SLA. Property behavior: - <i>read-only</i>
name	string	- <i>required</i> for update operations Name of the SLA. Property behavior: - <i>required</i> for create operations
period	integer	Reporting period of the SLA. Possible values: 0 - daily; 1 - weekly; 2 - monthly; 3 - quarterly; 4 - annually.
slo	float	- <i>required</i> for create operations Minimum acceptable Service Level Objective expressed as a percent. If the Service Level Indicator (SLI) drops lower, the SLA is considered to be in problem/unfulfilled state. Possible values: 0-100 (up to 4 fractional digits).
effective_date	integer	- <i>required</i> for create operations Effective date of the SLA. Possible values: date timestamp in UTC.

Property	Type	Description
timezone	string	Reporting time zone, for example: Europe/London, UTC. For the full list of supported time zones please refer to PHP documentation .
status	integer	Property behavior: - <i>required</i> for create operations Status of the SLA. Possible values: 0 - (<i>default</i>) disabled SLA; 1 - enabled SLA.
description	string	Description of the SLA.

SLA Schedule

The SLA schedule object defines periods where the connected service(s) are scheduled to be in working order. It has the following properties.

Property	Type	Description
period_from	integer	Starting time of the recurrent weekly period of time (inclusive). Possible values: number of seconds (counting from Sunday).
period_to	integer	Property behavior: - <i>required</i> Ending time of the recurrent weekly period of time (exclusive). Possible values: number of seconds (counting from Sunday). Property behavior: - <i>required</i>

SLA excluded downtime

The excluded downtime object defines periods where the connected service(s) are scheduled to be out of working order, without affecting SLI, e.g., undergoing planned maintenance. It has the following properties.

Property	Type	Description
name	string	Name of the excluded downtime.
period_from	integer	Property behavior: - <i>required</i> Starting time of the excluded downtime (inclusive). Possible values: timestamp.
period_to	integer	Property behavior: - <i>required</i> Ending time of the excluded downtime (exclusive). Possible values: timestamp. Property behavior: - <i>required</i>

SLA service tag

The SLA service tag object links services to include in the calculations for the SLA. It has the following properties.

Property	Type	Description
tag	string	SLA service tag name.
operator	integer	<p>Property behavior: - <i>required</i></p> <p>SLA service tag operator.</p>
value	string	<p>Possible values: 0 - (<i>default</i>) equals; 2 - contains.</p> <p>SLA service tag value.</p>

sla.create

Description

object `sla.create(object/array SLAs)`

This method allows to create new SLA objects.

Note:

This method is only available to *Admin* and *Super admin* user types. Permissions to call the method can be revoked in user role settings. See [User roles](#) for more information.

Parameters

(object/array) SLA objects to create.

Additionally to the [standard SLA properties](#), the method accepts the following parameters.

Parameter	Type	Description
service_tags	array	<p>SLA service tags to be created for the SLA.</p> <p>Parameter behavior: - <i>required</i></p>
schedule	array	<p>SLA schedule to be created for the SLA. Specifying an empty parameter will be interpreted as a 24x7 schedule. Default: 24x7 schedule.</p>
excluded_downtimes	array	SLA excluded downtimes to be created for the SLA.

Return values

(object) Returns an object containing the IDs of the created SLAs under the `slaids` property. The order of the returned IDs matches the order of the passed SLAs.

Examples

Creating an SLA

Instruct to create an SLA entry for: * tracking uptime for SQL-engine related services; * custom schedule of all weekdays excluding last hour on Saturday; * an effective date of the last day of the year 2022; * with 1 hour and 15 minutes long planned downtime starting at midnight on the 4th of July; * SLA weekly report calculation will be on; * the minimum acceptable SLO will be 99.9995%.

Request:

```
{
  "jsonrpc": "2.0",
  "method": "sla.create",
  "params": [
    {
      "name": "Database Uptime",
      "slo": "99.9995",
      "period": "1",
      "timezone": "America/Toronto",
    }
  ]
}
```

```

    "description": "Provide excellent uptime for main database engines.",
    "effective_date": 1672444800,
    "status": 1,
    "schedule": [
      {
        "period_from": 0,
        "period_to": 601200
      }
    ],
    "service_tags": [
      {
        "tag": "database",
        "operator": "0",
        "value": "mysql"
      },
      {
        "tag": "database",
        "operator": "0",
        "value": "postgresql"
      }
    ],
    "excluded_downtimes": [
      {
        "name": "Software version upgrade rollout",
        "period_from": "1648760400",
        "period_to": "1648764900"
      }
    ]
  }
],
  "id": 1
}

```

Response:

```

{
  "jsonrpc": "2.0",
  "result": {
    "slaid": [
      "5"
    ]
  },
  "id": 1
}

```

Source

CSla::create() in `ui/include/classes/api/services/CSla.php`.

sla.delete

Description

object `sla.delete(array slaid)`

This method allows to delete SLA entries.

Note:

This method is only available to *Admin* and *Super admin* user types. Permissions to call the method can be revoked in user role settings. See [User roles](#) for more information.

Parameters

(array) IDs of the SLAs to delete.

Return values

(object) Returns an object containing the IDs of the deleted SLAs under the `slaid`s property.

Examples

Deleting multiple SLAs

Delete two SLA entries.

Request:

```
{
  "jsonrpc": "2.0",
  "method": "sla.delete",
  "params": [
    "4",
    "5"
  ],
  "id": 1
}
```

Response:

```
{
  "jsonrpc": "2.0",
  "result": {
    "slaid": [
      "4",
      "5"
    ]
  },
  "id": 1
}
```

Source

`CSla::delete()` in `ui/include/classes/api/services/CSla.php`.

sla.get

Description

integer/array `sla.get(object parameters)`

The method allows to retrieve SLA objects according to the given parameters.

Note:

This method is available to users of any type. Permissions to call the method can be revoked in user role settings. See [User roles](#) for more information.

Parameters

(object) Parameters defining the desired output.

The method supports the following parameters.

Parameter	Type	Description
<code>slaid</code>	ID/array	Return only SLAs with the given IDs.
<code>serviceids</code>	ID/array	Return only SLAs matching the specific services.
<code>selectSchedule</code>	query	Return a <code>schedule</code> property with SLA schedules.
<code>selectExcludedDowntimesquery</code>		Supports count. Return an <code>excluded_downtimes</code> property with SLA excluded downtimes.
		Supports count.

Parameter	Type	Description
selectServiceTags	query	Return a <code>service_tags</code> property with SLA service tags.
sortfield	string/array	Supports count. Sort the result by the given properties. Possible values: <code>slaid</code> , <code>name</code> , <code>period</code> , <code>slo</code> , <code>effective_date</code> , <code>timezone</code> , <code>status</code> , <code>description</code> .
countOutput	boolean	These parameters being common for all get methods are described in detail in the reference commentary .
editable	boolean	
excludeSearch	boolean	
filter	object	
limit	integer	
output	query	
preservekeys	boolean	
search	object	
searchByAny	boolean	
searchWildcardsEnabled	boolean	
sortorder	string/array	
startSearch	boolean	

Return values

(integer/array) Returns either:

- an array of objects;
- the count of retrieved objects, if the `countOutput` parameter has been used.

Examples

Retrieving all SLAs

Retrieve all data about all SLAs and their properties.

Request:

```
{
  "jsonrpc": "2.0",
  "method": "sla.get",
  "params": {
    "output": "extend",
    "selectSchedule": ["period_from", "period_to"],
    "selectExcludedDowntimes": ["name", "period_from", "period_to"],
    "selectServiceTags": ["tag", "operator", "value"],
    "preservekeys": true
  },
  "id": 1
}
```

Response:

```
{
  "jsonrpc": "2.0",
  "result": {
    "1": {
      "slaid": "1",
      "name": "Database Uptime",
      "period": "1",
      "slo": "99.9995",
      "effective_date": "1672444800",
      "timezone": "America/Toronto",
      "status": "1",
      "description": "Provide excellent uptime for main SQL database engines.",
      "service_tags": [
        {

```

```

        "tag": "database",
        "operator": "0",
        "value": "mysql"
    },
    {
        "tag": "database",
        "operator": "0",
        "value": "postgresql"
    }
],
"schedule": [
    {
        "period_from": "0",
        "period_to": "601200"
    }
],
"excluded_downtimes": [
    {
        "name": "Software version upgrade rollout",
        "period_from": "1648760400",
        "period_to": "1648764900"
    }
]
}
},
"id": 1
}

```

Source

CSla::get() in `ui/include/classes/api/services/CSla.php`.

sla.getsli

Description

object sla.getsli(object parameters)

This method allows to calculate the Service Level Indicator (SLI) data for a Service Level Agreement (SLA).

Note:

This method is available to users of any type. Permissions to call the method can be revoked in user role settings. See [User roles](#) for more information.

Parameters

(object) Parameters containing the SLA ID, reporting periods and, optionally, the IDs of the services - to calculate the SLI for.

Parameter	Type	Description
slaid	ID	ID of the SLA to return availability information for.
period_from	timestamp	Starting date (inclusive) to report the SLI for.
period_to	timestamp	Ending date (exclusive) to report the SLI for.
periods	array	Preferred number of periods to report.
serviceids	ID/array	IDs of services to return the SLI for.

Partitioning of periods

The following table demonstrates the arrangement of returned period slices based on combinations of parameters.

Note:

The returned periods will not precede the first available period based on the effective date of the SLA and will not exceed the current period.

Parameters			Description
period_from	period_to	periods	
-	-	-	Return the last 20 periods.
-	-	specified	Return the last periods specified by the periods parameter.
-	specified	-	Return the last 20 periods before the specified period_to date.
-	specified	specified	Return the last periods specified by the periods parameter before the specified period_to date.
specified	-	-	Return the first 20 periods starting with the specified period_from date.
specified	-	specified	Return the first periods specified by the periods parameter starting with the specified period_from date.
specified	specified	-	Return up to 100 periods within the specified date range.
specified	specified	specified	Return periods specified by the periods parameter within the specified date range.

Return values

(object) Returns the results of the calculation.

Property	Type	Description
periods	array	List of the reported periods. Each reported period is represented as an object consisting of: - period_from - Starting date of the reported period (timestamp). - period_to - Ending date of the reported period (timestamp).
serviceids	array	Periods are sorted by period_from field ascending. List of service IDs in the reported periods.
sli	array	The sorting order of the list is not defined. Even if serviceids parameter was passed to the <code>sla.getsli</code> method. SLI data (as a two-dimensional array) for each reported period and service. The index of the periods property is used as the first dimension of the sli property. The index of the serviceids property is used as the second dimension of the sli property.

SLI data

The SLI data returned for each reported period and service consists of:

Property	Type	Description
uptime	integer	Amount of time service spent in an OK state during scheduled uptime, less the excluded downtimes.

Property	Type	Description
downtime	integer	Amount of time service spent in a <i>not OK</i> state during scheduled uptime, less the excluded downtimes.
sli	float	SLI (per cent of total uptime), based on uptime and downtime.
error_budget	integer	Error budget (in seconds), based on the SLI and the SLO.
excluded_downtimes	array	Array of excluded downtimes in this reporting period.

Each object will contain the following parameters:

- `name` - Name of the excluded downtime.
- `period_from` - Starting date and time (inclusive) of the excluded downtime.
- `period_to` - Ending date and time (exclusive) of the excluded downtime.

Excluded downtimes are sorted by `period_from` field ascending.

Examples

Calculating SLI

Retrieve SLI data on services with IDs "50", "60" and "70" that are linked to the SLA with ID "5". Retrieve data for 3 periods starting from Nov 01, 2021.

Request:

```
{
  "jsonrpc": "2.0",
  "method": "sla.getsli",
  "params": {
    "slaid": "5",
    "serviceids": [
      50,
      60,
      70
    ],
    "periods": 3,
    "period_from": "1635724800"
  },
  "id": 1
}
```

Response:

```
{
  "jsonrpc": "2.0",
  "result": {
    "periods": [
      {
        "period_from": 1635724800,
        "period_to": 1638316800
      },
      {
        "period_from": 1638316800,
        "period_to": 1640995200
      },
      {
        "period_from": 1640995200,
        "period_to": 1643673600
      }
    ],
    "serviceids": [
      50,
      60,
      70
    ]
  }
}
```

```

],
"sli": [
  [
    {
      "uptime": 1186212,
      "downtime": 0,
      "sli": 100,
      "error_budget": 0,
      "excluded_downtimes": [
        {
          "name": "Excluded Downtime - 1",
          "period_from": 1637836212,
          "period_to": 1638316800
        }
      ]
    },
    {
      "uptime": 1186212,
      "downtime": 0,
      "sli": 100,
      "error_budget": 0,
      "excluded_downtimes": [
        {
          "name": "Excluded Downtime - 1",
          "period_from": 1637836212,
          "period_to": 1638316800
        }
      ]
    },
    {
      "uptime": 1186212,
      "downtime": 0,
      "sli": 100,
      "error_budget": 0,
      "excluded_downtimes": [
        {
          "name": "Excluded Downtime - 1",
          "period_from": 1637836212,
          "period_to": 1638316800
        }
      ]
    }
  ],
  [
    {
      "uptime": 1147548,
      "downtime": 0,
      "sli": 100,
      "error_budget": 0,
      "excluded_downtimes": [
        {
          "name": "Excluded Downtime - 1",
          "period_from": 1638439200,
          "period_to": 1639109652
        }
      ]
    },
    {
      "uptime": 1147548,
      "downtime": 0,
      "sli": 100,
      "error_budget": 0,
    }
  ]
]

```

```

        "excluded_downtimes": [
            {
                "name": "Excluded Downtime - 1",
                "period_from": 1638439200,
                "period_to": 1639109652
            }
        ]
    },
    {
        "uptime": 1147548,
        "downtime": 0,
        "sli": 100,
        "error_budget": 0,
        "excluded_downtimes": [
            {
                "name": "Excluded Downtime - 1",
                "period_from": 1638439200,
                "period_to": 1639109652
            }
        ]
    }
],
[
    {
        "uptime": 1674000,
        "downtime": 0,
        "sli": 100,
        "error_budget": 0,
        "excluded_downtimes": []
    },
    {
        "uptime": 1674000,
        "downtime": 0,
        "sli": 100,
        "error_budget": 0,
        "excluded_downtimes": []
    },
    {
        "uptime": 1674000,
        "downtime": 0,
        "sli": 100,
        "error_budget": 0,
        "excluded_downtimes": []
    }
]
],
    "id": 1
}

```

Source

`CSla::getSli()` in `ui/include/classes/api/services/CSla.php`

sla.update

Description

object `sla.update(object/array slaid)`

This method allows to update existing SLA entries.

Note:

This method is only available to *Admin* and *Super admin* user types. Permissions to call the method can be revoked in user role settings. See [User roles](#) for more information.

Parameters

(object/array) SLA properties to be updated.

The `slaid` property must be defined for each SLA, all other properties are optional. Only the passed properties will be updated, all others will remain unchanged.

Additionally to the [standard SLA properties](#), the method accepts the following parameters.

Parameter	Type	Description
<code>service_tags</code>	array	SLA service tags to replace the current SLA service tags.
<code>schedule</code>	array	SLA schedule to replace the current one. Specifying parameter as empty will be interpreted as a 24x7 schedule.
<code>excluded_downtimes</code>	array	SLA excluded downtimes to replace the current ones.

Return values

(object) Returns an object containing the IDs of the updated SLAs under the `slaid`s property.

Examples**Updating service tags**

Make SLA with ID "5" to be calculated at monthly intervals for NoSQL related services, without changing its schedule or excluded downtimes; set SLO to 95%.

Request:

```
{
  "jsonrpc": "2.0",
  "method": "sla.update",
  "params": [
    {
      "slaid": "5",
      "name": "NoSQL Database engines",
      "slo": "95",
      "period": 2,
      "service_tags": [
        {
          "tag": "database",
          "operator": "0",
          "value": "redis"
        },
        {
          "tag": "database",
          "operator": "0",
          "value": "mongodb"
        }
      ]
    }
  ],
  "id": 1
}
```

Response:

```
{
  "jsonrpc": "2.0",
  "result": {
    "slaid": [
      "5"
    ]
  }
}
```

```
  },
  "id": 1
}
```

Changing the schedule of an SLA

Switch the SLA with ID "5" to a 24x7 schedule.

Request:

```
{
  "jsonrpc": "2.0",
  "method": "service.update",
  "params": {
    "slaid": "5",
    "schedule": []
  },
  "id": 1
}
```

Response:

```
{
  "jsonrpc": "2.0",
  "result": {
    "slaid": [
      "5"
    ]
  },
  "id": 1
}
```

Changing the excluded downtimes for an SLA

Add a planned 4 hour long RAM upgrade downtime on the 6th of April, 2022, while keeping (needs to be defined anew) a previously existing software upgrade planned on the 4th of July for the SLA with ID "5".

Request:

```
{
  "jsonrpc": "2.0",
  "method": "service.update",
  "params": {
    "slaid": "5",
    "excluded_downtimes": [
      {
        "name": "Software version upgrade rollout",
        "period_from": "1648760400",
        "period_to": "1648764900"
      },
      {
        "name": "RAM upgrade",
        "period_from": "1649192400",
        "period_to": "1649206800"
      }
    ]
  },
  "id": 1
}
```

Response:

```
{
  "jsonrpc": "2.0",
  "result": {
    "slaid": [
      "5"
    ]
  }
}
```



```

    },
    "id": 1
}

```

Source

CSla::update() in *ui/include/classes/api/services/CSla.php*.

Task

This class is designed to work with tasks (such as checking items or low-level discovery rules without config reload).

Object references:

- [Task](#)
- 'Execute now' request object
- 'Refresh proxy configuration' request object
- 'Diagnostic information' request object
- Statistic request object
- Statistic result object

Available methods:

- [task.create](#) - create new tasks
- [task.get](#) - retrieve tasks

Task object

The following objects are directly related to the task API.

The task object has the following properties:

Property	Type	Description
taskid	ID	ID of the task.
type	integer	<p>Property behavior: - <i>read-only</i></p> <p>Type of the task.</p> <p>Possible values: 1 - Diagnostic information; 2 - Refresh proxy configuration; 6 - Execute now.</p>
status	integer	<p>Property behavior: - <i>required</i></p> <p>Status of the task.</p> <p>Possible values: 1 - new task; 2 - task in progress; 3 - task is completed; 4 - task is expired.</p>
clock	timestamp	<p>Property behavior: - <i>read-only</i></p> <p>Time when the task was created.</p>
ttl	integer	<p>Property behavior: - <i>read-only</i></p> <p>The time in seconds after which task expires.</p> <p>Property behavior: - <i>read-only</i></p>

Property	Type	Description
proxyid	ID	ID of the proxy about which diagnostic information statistic is collected.
request	object	<p>Property behavior:</p> <ul style="list-style-type: none"> - <i>supported</i> if type is set to "Diagnostic information" or "Refresh proxy configuration" <p>Task request object according to the task type: Object of 'Execute now' task is described in detail below; Object of 'Refresh proxy configuration' task is described in detail below; Object of 'Diagnostic information' task is described in detail below.</p>
result	object	<p>Property behavior:</p> <ul style="list-style-type: none"> - <i>required</i> <p>Result object of the diagnostic information task. May contain NULL if result is not yet ready. Result object is described in detail below.</p> <p>Property behavior:</p> <ul style="list-style-type: none"> - <i>read-only</i>

'Execute now' request object

The 'Execute now' task request object has the following properties.

Property	Type	Description
itemid	ID	ID of item and low-level discovery rules.

'Refresh proxy configuration' request object

The 'Refresh proxy configuration' task request object has the following properties.

Property	Type	Description
proxyids	array	Proxy IDs.

'Diagnostic information' request object

The diagnostic information task request object has the following properties. Statistic request object for all types of properties is [described in detail below](#).

Property	Type	Description
historycache	object	History cache statistic request. Available on server and proxy.
valuecache	object	Items cache statistic request. Available on server.
preprocessing	object	Preprocessing manager statistic request. Available on server and proxy.
alerting	object	Alert manager statistic request. Available on server.
lld	object	LLD manager statistic request. Available on server.

Statistic request object

Statistic request object is used to define what type of information should be collected about server/proxy internal processes. It has the following properties.

Property	Type	Description
stats	query	<p>Statistic object properties to be returned. The list of available fields for each type of diagnostic information statistic are described in detail below.</p> <p>Default: <code>extend</code> will return all available statistic fields.</p>

Property	Type	Description
top	object	Object to sort and limit returned statistic values. The list of available fields for each type of diagnostic information statistic are described in detail below . Example: { "source.alerts": 10 }

List of statistic fields available for each type of diagnostic information request

Following statistic fields can be requested for each type of diagnostic information request property.

Diagnostic type	Available fields	Description
historycache	items	Number of cached items.
	values	Number of cached values.
	memory	Shared memory statistics (free space, number of used chunks, number of free chunks, max size of free chunk).
	memory.data	History data cache shared memory statistics.
valuecache	memory.index	History index cache shared memory statistics.
	items	Number of cached items.
	values	Number of cached values.
preprocessing	memory	Shared memory statistics (free space, number of used chunks, number of free chunks, max size of free chunk).
	mode	Value cache mode.
	values	Number of queued values.
alerting	preproc.values	Number of queued values with preprocessing steps.
	alerts	Number of queued alerts.
lld	rules	Number of queued rules.
	values	Number of queued values.

List of sorting fields available for each type of diagnostic information request

Following statistic fields can be used to sort and limit requested information.

Diagnostic type	Available fields	Type
historycache	values	integer
valuecache	values	integer
	request.values	integer
preprocessing	values	integer
alerting	media.alerts	integer
	source.alerts	integer
lld	values	integer

Statistic result object

Statistic result object is retrieved in `result` field of task object.

Property	Type	Description
status	integer	Status of the task result. Possible values: -1 - error occurred during performing task; 0 - task result is created. Property behavior: - <i>read-only</i>
data	string/object	Results according the statistic request object of particular diagnostic information task. Contains error message string if error occurred during performing task.

task.create

Description

object task.create(object/array tasks)

This method allows to create a new task (such as collect diagnostic data or check items or low-level discovery rules without config reload).

Note:

This method is only available to *Super admin* user type. Permissions to call the method can be revoked in user role settings. See [User roles](#) for more information.

Parameters

(object/array) A task to create.

The method accepts tasks with the [standard task properties](#).

Note that 'Execute now' tasks can be created only for the following types of items/discovery rules:

- Zabbix agent
- SNMPv1/v2/v3 agent
- Simple check
- Internal check
- External check
- Database monitor
- HTTP agent
- IPMI agent
- SSH agent
- TELNET agent
- Calculated check
- JMX agent
- Dependent item

If item or discovery rule is of type "Dependent item", then top level master item must be of type:

- Zabbix agent
- SNMPv1/v2/v3 agent
- Simple check
- Internal check
- External check
- Database monitor
- HTTP agent
- IPMI agent
- SSH agent
- TELNET agent
- Calculated check
- JMX agent

Return values

(object) Returns an object containing the IDs of the created tasks under the `taskids` property. One task is created for each item and low-level discovery rule. The order of the returned IDs matches the order of the passed `itemids`.

Examples

Creating a task

Create a task `Execute now` for two items. One is an item, the other is a low-level discovery rule.

Request:

```
{
  "jsonrpc": "2.0",
  "method": "task.create",
  "params": [
    {
      "type": 6,
      "request": {
```

```

        "itemid": "10092"
      }
    },
    {
      "type": 6,
      "request": {
        "itemid": "10093"
      }
    }
  ],
  "id": 1
}

```

Response:

```

{
  "jsonrpc": "2.0",
  "result": {
    "taskids": [
      "1",
      "2"
    ]
  },
  "id": 1
}

```

Create a task Refresh proxy configuration for two proxies.

Request:

```

{
  "jsonrpc": "2.0",
  "method": "task.create",
  "params": [
    {
      "type": 2,
      "request": {
        "proxyids": ["10459", "10460"]
      }
    }
  ],
  "id": 1
}

```

Response:

```

{
  "jsonrpc": "2.0",
  "result": {
    "taskids": [
      "1"
    ]
  },
  "id": 1
}

```

Create a task diagnostic information.

Request:

```

{
  "jsonrpc": "2.0",
  "method": "task.create",
  "params": [
    {
      "type": 1,
      "request": {

```

```

        "alerting": {
            "stats": [
                "alerts"
            ],
            "top": {
                "media.alerts": 10
            }
        },
        "lld": {
            "stats": "extend",
            "top": {
                "values": 5
            }
        }
    },
    "proxyid": 0
}
],
"id": 1
}

```

Response:

```

{
    "jsonrpc": "2.0",
    "result": {
        "taskids": [
            "3"
        ]
    },
    "id": 1
}

```

See also

- [Task](#)
- 'Execute now' request object
- 'Diagnostic information' request object
- [Statistic request object](#)

Source

`CTask::create()` in `ui/include/classes/api/services/CTask.php`.

task.get

Description

integer/array `task.get(object parameters)`

The method allows to retrieve tasks according to the given parameters. Method returns details only about 'diagnostic information' tasks.

Note:

This method is only available to *Super admin* user type. Permissions to call the method can be revoked in user role settings. See [User roles](#) for more information.

Parameters

(object) Parameters defining the desired output.

The method supports the following parameters.

Parameter	Type	Description
taskids	ID/array	Return only tasks with the given IDs.

Parameter	Type	Description
output	query	These parameters being common for all get methods are described in detail in the reference commentary .
preservekeys	boolean	

Return values

(integer/array) Returns an array of objects.

Examples

Retrieve task by ID

Retrieve all the data about the task with the ID "1".

Request:

```
{
  "jsonrpc": "2.0",
  "method": "task.get",
  "params": {
    "output": "extend",
    "taskids": "1"
  },
  "id": 1
}
```

Response:

```
{
  "jsonrpc": "2.0",
  "result": [
    {
      "taskid": "1",
      "type": "7",
      "status": "3",
      "clock": "1601039076",
      "ttl": "3600",
      "proxyid": null,
      "request": {
        "alerting": {
          "stats": [
            "alerts"
          ],
          "top": {
            "media.alerts": 10
          }
        },
        "lld": {
          "stats": "extend",
          "top": {
            "values": 5
          }
        }
      },
      "result": {
        "data": {
          "alerting": {
            "alerts": 0,
            "top": {
              "media.alerts": []
            }
          },
          "time": 0.000663
        },
        "lld": {
```

```

        "rules": 0,
        "values": 0,
        "top": {
            "values": []
        },
        "time": 0.000442
    },
    "status": "0"
}
],
"id": 1
}

```

See also

- [Task](#)
- [Statistic result object](#)

Source

CTask::get() in *ui/include/classes/api/services/CTask.php*.

Template

This class is designed to work with templates.

Object references:

- [Template](#)
- [Template tag](#)

Available methods:

- [template.create](#) - create new templates
- [template.delete](#) - delete templates
- [template.get](#) - retrieve templates
- [template.massadd](#) - add related objects to templates
- [template.massremove](#) - remove related objects from templates
- [template.massupdate](#) - replace or remove related objects from templates
- [template.update](#) - update templates

Template object

The following objects are directly related to the `template` API.

Template

The template object has the following properties.

Property	Type	Description
templateid	ID	ID of the template.
host	string	<p>Property behavior:</p> <ul style="list-style-type: none"> - <i>read-only</i> - <i>required</i> for update operations Technical name of the template.
description	text	<p>Property behavior:</p> <ul style="list-style-type: none"> - <i>required</i> for create operations Description of the template.
name	string	Visible name of the template. <p>Default: <code>host</code> property value.</p>

Property	Type	Description
uuid	string	Universal unique identifier, used for linking imported templates to already existing ones. Auto-generated, if not given.
vendor_name	string	Template vendor name.
vendor_version	string	<p>For create operations, both <code>vendor_name</code> and <code>vendor_version</code> should be either set or left empty. For update operations, <code>vendor_version</code> can be left empty if it has a value in the database.</p> <p>Template vendor version.</p> <p>For create operations, both <code>vendor_name</code> and <code>vendor_version</code> should be either set or left empty. For update operations, <code>vendor_name</code> can be left empty if it has a value in the database.</p>

Template tag

The template tag object has the following properties.

Property	Type	Description
tag	string	Template tag name. Property behavior: - <i>required</i>
value	string	Template tag value.

template.create

Description

`object template.create(object/array templates)`

This method allows to create new templates.

Note:

This method is only available to *Admin* and *Super admin* user types. Permissions to call the method can be revoked in user role settings. See [User roles](#) for more information.

Parameters

(object/array) Templates to create.

Additionally to the [standard template properties](#), the method accepts the following parameters.

Parameter	Type	Description
groups	object/array	<p>Template groups to add the template to.</p> <p>The template groups must have only the <code>groupid</code> property defined.</p> <p>Parameter behavior: - <i>required</i></p>
tags	object/array	Template tags.
templates	object/array	<p>Templates to be linked to the template.</p> <p>The templates must have only the <code>templateid</code> property defined.</p>
macros	object/array	User macros to be created for the template.

Return values

(object) Returns an object containing the IDs of the created templates under the `templateids` property. The order of the returned IDs matches the order of the passed templates.

Examples

Creating a template

Create a template with tags and link two templates to this template.

Request:

```
{
  "jsonrpc": "2.0",
  "method": "template.create",
  "params": {
    "host": "Linux template",
    "groups": {
      "groupid": 1
    },
    "templates": [
      {
        "templateid": "11115"
      },
      {
        "templateid": "11116"
      }
    ],
    "tags": [
      {
        "tag": "host-name",
        "value": "{HOST.NAME}"
      }
    ]
  },
  "id": 1
}
```

Response:

```
{
  "jsonrpc": "2.0",
  "result": {
    "templateids": [
      "11117"
    ]
  },
  "id": 1
}
```

Source

CTemplate::create() in `ui/include/classes/api/services/CTemplate.php`.

template.delete

Description

object `template.delete(array templateIds)`

This method allows to delete templates.

Deleting a template will cause deletion of all template entities (items, triggers, graphs, etc.). To leave template entities with the hosts, but delete the template itself, first unlink the template from required hosts using one of these methods: [template.update](#), [template.massupdate](#), [host.update](#), [host.massupdate](#).

Note:

This method is only available to *Admin* and *Super admin* user types. Permissions to call the method can be revoked in user role settings. See [User roles](#) for more information.

Parameters

(array) IDs of the templates to delete.

Return values

(object) Returns an object containing the IDs of the deleted templates under the `templateids` property.

Examples

Deleting multiple templates

Delete two templates.

Request:

```
{
  "jsonrpc": "2.0",
  "method": "template.delete",
  "params": [
    "13",
    "32"
  ],
  "id": 1
}
```

Response:

```
{
  "jsonrpc": "2.0",
  "result": {
    "templateids": [
      "13",
      "32"
    ]
  },
  "id": 1
}
```

Source

`CTemplate::delete()` in `ui/include/classes/api/services/CTemplate.php`.

template.get

Description

`integer/array template.get(object parameters)`

The method allows to retrieve templates according to the given parameters.

Note:

This method is available to users of any type. Permissions to call the method can be revoked in user role settings. See [User roles](#) for more information.

Parameters

(object) Parameters defining the desired output.

The method supports the following parameters.

Parameter	Type	Description
<code>templateids</code>	ID/array	Return only templates with the given template IDs.
<code>groupids</code>	ID/array	Return only templates that belong to the given template groups.
<code>parentTemplateids</code>	ID/array	Return only templates that the given template is linked to.
<code>hostids</code>	ID/array	Return only templates that are linked to the given hosts/templates.
<code>graphids</code>	ID/array	Return only templates that contain the given graphs.
<code>itemids</code>	ID/array	Return only templates that contain the given items.
<code>triggerids</code>	ID/array	Return only templates that contain the given triggers.
<code>with_items</code>	flag	Return only templates that have items.
<code>with_triggers</code>	flag	Return only templates that have triggers.
<code>with_graphs</code>	flag	Return only templates that have graphs.

Parameter	Type	Description
with_httpstests	flag	Return only templates that have web scenarios.
evaltype	integer	Rules for tag searching. Possible values: 0 - (default) And/Or; 2 - Or.
tags	object/array	Return only templates with given tags. Exact match by tag and case-sensitive or case-insensitive search by tag value depending on operator value. Format: [{"tag": "<tag>", "value": "<value>", "operator": "<operator>"}, ...]. An empty array returns all templates. Possible operator values: 0 - (default) Contains; 1 - Equals; 2 - Not like; 3 - Not equal; 4 - Exists; 5 - Not exists.
selectTags	query	Return template tags in the tags property.
selectHosts	query	Return the hosts that are linked to the template in the hosts property.
selectTemplateGroups	query	Supports count. Return the template groups that the template belongs to in the templategroups property.
selectTemplates	query	Return templates to which the given template is linked in the templates property.
selectParentTemplates	query	Supports count. Return templates that are linked to the given template in the parentTemplates property.
selectHttpTests	query	Supports count. Return the web scenarios from the template in the httpTests property.
selectItems	query	Supports count. Return items from the template in the items property.
selectDiscoveries	query	Supports count. Return low-level discoveries from the template in the discoveries property.
selectTriggers	query	Supports count. Return triggers from the template in the triggers property.
selectGraphs	query	Supports count. Return graphs from the template in the graphs property.
selectMacros	query	Supports count. Return the macros from the template in the macros property.
selectDashboards	query	Return dashboards from the template in the dashboards property.
selectValueMaps	query	Supports count. Return a valuemaps property with template value maps.

Parameter	Type	Description
limitSelects	integer	Limits the number of records returned by subselects. Applies to the following subselects: selectTemplates - results will be sorted by name; selectHosts - sorted by host; selectParentTemplates - sorted by host; selectItems - sorted by name; selectDiscoveries - sorted by name; selectTriggers - sorted by description; selectGraphs - sorted by name; selectDashboards - sorted by name.
sortfield	string/array	Sort the result by the given properties. Possible values: hostid, host, name, status.
countOutput	boolean	These parameters being common for all get methods are described in detail in the reference commentary .
editable	boolean	
excludeSearch	boolean	
filter	object	
limit	integer	
output	query	
preservekeys	boolean	
search	object	
searchByAny	boolean	
searchWildcardsEnabled	boolean	
sortorder	string/array	
startSearch	boolean	

Return values

(integer/array) Returns either:

- an array of objects;
- the count of retrieved objects, if the countOutput parameter has been used.

Examples

Retrieving templates by name

Retrieve all data about two templates named "Linux" and "Windows".

Request:

```
{
  "jsonrpc": "2.0",
  "method": "template.get",
  "params": {
    "output": "extend",
    "filter": {
      "host": [
        "Linux",
        "Windows"
      ]
    }
  },
  "id": 1
}
```

Response:

```
{
  "jsonrpc": "2.0",
  "result": [
    {
      "proxyid": "0",
```

```

    "host": "Linux",
    "status": "3",
    "disable_until": "0",
    "error": "",
    "available": "0",
    "errors_from": "0",
    "lastaccess": "0",
    "ipmi_authtype": "0",
    "ipmi_privilege": "2",
    "ipmi_username": "",
    "ipmi_password": "",
    "ipmi_disable_until": "0",
    "ipmi_available": "0",
    "snmp_disable_until": "0",
    "snmp_available": "0",
    "maintenanceid": "0",
    "maintenance_status": "0",
    "maintenance_type": "0",
    "maintenance_from": "0",
    "ipmi_errors_from": "0",
    "snmp_errors_from": "0",
    "ipmi_error": "",
    "snmp_error": "",
    "jmx_disable_until": "0",
    "jmx_available": "0",
    "jmx_errors_from": "0",
    "jmx_error": "",
    "name": "Linux",
    "flags": "0",
    "templateid": "10001",
    "description": "",
    "tls_connect": "1",
    "tls_accept": "1",
    "tls_issuer": "",
    "tls_subject": "",
    "tls_psk_identity": "",
    "tls_psk": "",
    "uuid": "282ffe33afc74cccaf1524d9aa9dc502"
  },
  {
    "proxyid": "0",
    "host": "Windows",
    "status": "3",
    "disable_until": "0",
    "error": "",
    "available": "0",
    "errors_from": "0",
    "lastaccess": "0",
    "ipmi_authtype": "0",
    "ipmi_privilege": "2",
    "ipmi_username": "",
    "ipmi_password": "",
    "ipmi_disable_until": "0",
    "ipmi_available": "0",
    "snmp_disable_until": "0",
    "snmp_available": "0",
    "maintenanceid": "0",
    "maintenance_status": "0",
    "maintenance_type": "0",
    "maintenance_from": "0",
    "ipmi_errors_from": "0",
    "snmp_errors_from": "0",

```

```

        "ipmi_error": "",
        "snmp_error": "",
        "jmx_disable_until": "0",
        "jmx_available": "0",
        "jmx_errors_from": "0",
        "jmx_error": "",
        "name": "Windows",
        "flags": "0",
        "templateid": "10081",
        "description": "",
        "tls_connect": "1",
        "tls_accept": "1",
        "tls_issuer": "",
        "tls_subject": "",
        "tls_psk_identity": "",
        "tls_psk": "",
        "uuid": "522d17e1834049be879287b7c0518e5d"
    }
],
    "id": 1
}

```

Retrieving template groups

Retrieve template groups that the template "Linux by Zabbix agent" is a member of.

Request:

```

{
    "jsonrpc": "2.0",
    "method": "template.get",
    "params": {
        "output": ["hostid"],
        "selectTemplateGroups": "extend",
        "filter": {
            "host": [
                "Linux by Zabbix agent"
            ]
        }
    }
},
    "id": 1
}

```

Response:

```

{
    "jsonrpc": "2.0",
    "result": [
        {
            "templateid": "10001",
            "templategroups": [
                {
                    "groupid": "10",
                    "name": "Templates/Operating systems",
                    "uuid": "846977d1dfed4968bc5f8bdb363285bc"
                }
            ]
        }
    ]
},
    "id": 1
}

```

Retrieving hosts by template

Retrieve hosts that have the "10001" (*Linux by Zabbix agent*) template linked to them.

Request:

```

{
  "jsonrpc": "2.0",
  "method": "template.get",
  "params": {
    "output": "templateid",
    "templateids": "10001",
    "selectHosts": ["hostid", "name"]
  },
  "id": 1
}

```

Response:

```

{
  "jsonrpc": "2.0",
  "result": [
    {
      "templateid": "10001",
      "hosts": [
        {
          "hostid": "10084",
          "name": "Zabbix server"
        },
        {
          "hostid": "10603",
          "name": "Host 1"
        },
        {
          "hostid": "10604",
          "name": "Host 2"
        }
      ]
    }
  ],
  "id": 1
}

```

Searching by template tags

Retrieve templates that have tag "host-name" equal to "{HOST.NAME}".

Request:

```

{
  "jsonrpc": "2.0",
  "method": "template.get",
  "params": {
    "output": ["hostid"],
    "selectTags": "extend",
    "evaltype": 0,
    "tags": [
      {
        "tag": "host-name",
        "value": "{HOST.NAME}",
        "operator": 1
      }
    ]
  },
  "id": 1
}

```

Response:

```

{
  "jsonrpc": "2.0",
  "result": [

```



```

    {
      "hostid": "10402",
      "tags": [
        {
          "tag": "host-name",
          "value": "{HOST.NAME}"
        }
      ]
    }
  ],
  "id": 1
}

```

See also

- [Template group](#)
- [Template](#)
- [User macro](#)
- [Host interface](#)

Source

CTemplate::get() in `ui/include/classes/api/services/CTemplate.php`.

template.massadd

Description

object template.massadd(object parameters)

This method allows to simultaneously add multiple related objects to the given templates.

Note:

This method is only available to *Admin* and *Super admin* user types. Permissions to call the method can be revoked in user role settings. See [User roles](#) for more information.

Parameters

(object) Parameters containing the IDs of the templates to update and the objects to add to the templates.

The method accepts the following parameters.

Parameter	Type	Description
templates	object/array	<p>Templates to be updated.</p> <p>The templates must have only the <code>templateid</code> property defined.</p>
groups	object/array	<p>Parameter behavior: - <i>required</i></p> <p>Template groups to add the given templates to.</p> <p>The template groups must have only the <code>groupid</code> property defined.</p>
macros	object/array	<p>User macros to be created for the given templates.</p>
templates_link	object/array	<p>Templates to link to the given templates.</p> <p>The templates must have only the <code>templateid</code> property defined.</p>

Return values

(object) Returns an object containing the IDs of the updated templates under the `templateids` property.

Examples

Link a group to templates

Add template group "2" to two templates.

Request:

```
{
  "jsonrpc": "2.0",
  "method": "template.massadd",
  "params": {
    "templates": [
      {
        "templateid": "10085"
      },
      {
        "templateid": "10086"
      }
    ],
    "groups": [
      {
        "groupid": "2"
      }
    ]
  },
  "id": 1
}
```

Response:

```
{
  "jsonrpc": "2.0",
  "result": {
    "templateids": [
      "10085",
      "10086"
    ]
  },
  "id": 1
}
```

Link two templates to a template

Link templates "10106" and "10104" to template "10073".

Request:

```
{
  "jsonrpc": "2.0",
  "method": "template.massadd",
  "params": {
    "templates": [
      {
        "templateid": "10073"
      }
    ],
    "templates_link": [
      {
        "templateid": "10106"
      },
      {
        "templateid": "10104"
      }
    ]
  },
  "id": 1
}
```

Response:

```
{
  "jsonrpc": "2.0",
```

```

    "result": {
      "templateids": [
        "10073"
      ]
    },
    "id": 1
  }
}

```

See also

- [template.update](#)
- [Host](#)
- [Template group](#)
- [User macro](#)

Source

CTemplate::massAdd() in `ui/include/classes/api/services/CTemplate.php`.

template.massremove

Description

object `template.massremove(object parameters)`

This method allows to remove related objects from multiple templates.

Note:

This method is only available to *Admin* and *Super admin* user types. Permissions to call the method can be revoked in user role settings. See [User roles](#) for more information.

Parameters

(object) Parameters containing the IDs of the templates to update and the objects that should be removed.

Parameter	Type	Description
templateids	ID/array	IDs of the templates to be updated.
groupids	ID/array	IDs of the template groups from which to remove the given templates.
macros	string/array	IDs of the user macros to delete from the given templates.
templateids_clear	ID/array	IDs of the templates to unlink and clear from the given templates (upstream).
templateids_link	ID/array	IDs of the templates to unlink from the given templates (upstream).

Parameter behavior:

- *required*

Return values

(object) Returns an object containing the IDs of the updated templates under the `templateids` property.

Examples

Removing templates from a group

Remove two templates from group "2".

Request:

```

{
  "jsonrpc": "2.0",
  "method": "template.massremove",
  "params": {
    "templateids": [
      "10085",
      "10086"
    ]
  }
}

```

```
    "groupids": "2"
  },
  "id": 1
}
```

Response:

```
{
  "jsonrpc": "2.0",
  "result": {
    "templateids": [
      "10085",
      "10086"
    ]
  },
  "id": 1
}
```

Unlinking templates from a host

Unlink templates "10106" and "10104" from template "10085".

Request:

```
{
  "jsonrpc": "2.0",
  "method": "template.massremove",
  "params": {
    "templateids": "10085",
    "templateids_link": [
      "10106",
      "10104"
    ]
  },
  "id": 1
}
```

Response:

```
{
  "jsonrpc": "2.0",
  "result": {
    "templateids": [
      "10085"
    ]
  },
  "id": 1
}
```

See also

- [template.update](#)
- [User macro](#)

Source

CTemplate::massRemove() in *ui/include/classes/api/services/CTemplate.php*.

template.massupdate

Description

object template.massupdate(object parameters)

This method allows to simultaneously replace or remove related objects and update properties on multiple templates.

Note:

This method is only available to *Admin* and *Super admin* user types. Permissions to call the method can be revoked in user role settings. See [User roles](#) for more information.

Parameters

(object) Parameters containing the IDs of the templates to update and the objects to replace for the templates.

The method accepts the following parameters.

Parameter	Type	Description
templates	object/array	<p>Templates to be updated.</p> <p>The templates must have only the <code>templateid</code> property defined.</p> <p>Parameter behavior: - <i>required</i></p>
groups	object/array	<p>Template groups to replace the current template groups the templates belong to.</p> <p>The template groups must have only the <code>groupid</code> property defined.</p>
macros	object/array	<p>User macros to replace all of the current user macros on the given templates.</p>
templates_clear	object/array	<p>Templates to unlink and clear from the given templates.</p>
templates_link	object/array	<p>The templates must have only the <code>templateid</code> property defined.</p> <p>Templates to replace the currently linked templates.</p> <p>The templates must have only the <code>templateid</code> property defined.</p>

Return values

(object) Returns an object containing the IDs of the updated templates under the `templateids` property.

Examples**Unlinking a template**

Unlink and clear template "10091" from the given templates.

Request:

```
{
  "jsonrpc": "2.0",
  "method": "template.massupdate",
  "params": {
    "templates": [
      {
        "templateid": "10085"
      },
      {
        "templateid": "10086"
      }
    ],
    "templates_clear": [
      {
        "templateid": "10091"
      }
    ]
  },
  "id": 1
}
```

Response:

```
{
  "jsonrpc": "2.0",
  "result": {
    "templateids": [
      "10085",
      "10086"
    ]
  },
  "id": 1
}
```

Replacing user macros

Replace all user macros with the given user macro on multiple templates.

Request:

```
{
  "jsonrpc": "2.0",
  "method": "template.massupdate",
  "params": {
    "templates": [
      {
        "templateid": "10074"
      },
      {
        "templateid": "10075"
      },
      {
        "templateid": "10076"
      },
      {
        "templateid": "10077"
      }
    ],
    "macros": [
      {
        "macro": "${AGENT.TIMEOUT}",
        "value": "5m",
        "description": "Timeout after which agent is considered unavailable. Works only for agents"
      }
    ]
  },
  "id": 1
}
```

Response:

```
{
  "jsonrpc": "2.0",
  "result": {
    "templateids": [
      "10074",
      "10075",
      "10076",
      "10077"
    ]
  },
  "id": 1
}
```

See also

- [template.update](#)
- [template.massadd](#)
- [Template group](#)

- [User macro](#)

Source

CTemplate::massUpdate() in *ui/include/classes/api/services/CTemplate.php*.

template.update

Description

object template.update(object/array templates)

This method allows to update existing templates.

Note:

This method is only available to *Admin* and *Super admin* user types. Permissions to call the method can be revoked in user role settings. See [User roles](#) for more information.

Parameters

(object/array) Template properties to be updated.

The `templateid` property must be defined for each template, all other properties are optional. Only the given properties will be updated, all others will remain unchanged.

Additionally to the [standard template properties](#), the method accepts the following parameters.

Parameter	Type	Description
groups	object/array	Template groups to replace the current template groups the templates belong to.
tags	object/array	The template groups must have only the <code>groupid</code> property defined. Template tags to replace the current template tags.
macros	object/array	User macros to replace the current user macros on the given templates.
templates	object/array	Templates to replace the currently linked templates. Templates that are not passed are only unlinked.
templates_clear	object/array	The templates must have only the <code>templateid</code> property defined. Templates to unlink and clear from the given templates.
		The templates must have only the <code>templateid</code> property defined.

Return values

(object) Returns an object containing the IDs of the updated templates under the `templateids` property.

Examples

Renaming a template

Rename the template to "Template OS Linux".

Request:

```
{
  "jsonrpc": "2.0",
  "method": "template.update",
  "params": {
    "templateid": "10086",
    "name": "Template OS Linux"
  },
  "id": 1
}
```

Response:

```
{
  "jsonrpc": "2.0",
  "result": {
    "templateids": [
      "10086"
    ]
  },
  "id": 1
}
```

Updating template tags

Replace all template tags with a new one.

Request:

```
{
  "jsonrpc": "2.0",
  "method": "template.update",
  "params": {
    "templateid": "10086",
    "tags": [
      {
        "tag": "host-name",
        "value": "{HOST.NAME}"
      }
    ]
  },
  "id": 1
}
```

Response:

```
{
  "jsonrpc": "2.0",
  "result": {
    "templateids": [
      "10086"
    ]
  },
  "id": 1
}
```

Source

CTemplate::update() in *ui/include/classes/api/services/CTemplate.php*.

Template dashboard

This class is designed to work with template dashboards.

Object references:

- [Template dashboard](#)
- [Template dashboard page](#)
- [Template dashboard widget](#)
- [Template dashboard widget field](#)

Available methods:

- [templatedashboard.create](#) - create new template dashboards
- [templatedashboard.delete](#) - delete template dashboards
- [templatedashboard.get](#) - retrieve template dashboards
- [templatedashboard.update](#) - update template dashboards

Template dashboard object

The following objects are directly related to the `templatedashboard` API.

Template dashboard

The template dashboard object has the following properties.

Property	Type	Description
<code>dashboardid</code>	ID	ID of the template dashboard. Property behavior: - <i>read-only</i>
<code>name</code>	string	- <i>required</i> for update operations Name of the template dashboard. Property behavior: - <i>required</i> for create operations
<code>templateid</code>	ID	ID of the template the dashboard belongs to. Property behavior: - <i>constant</i> - <i>required</i> for create operations
<code>display_period</code>	integer	Default page display period (in seconds). Possible values: 10, 30, 60, 120, 600, 1800, 3600.
<code>auto_start</code>	integer	Default: 30. Auto start slideshow. Possible values: 0 - do not auto start slideshow; 1 - (<i>default</i>) auto start slideshow.
<code>uuid</code>	string	Universal unique identifier, used for linking imported template dashboards to already existing ones. Auto-generated, if not given.

Template dashboard page

The template dashboard page object has the following properties.

Property	Type	Description
<code>dashboard_pageid</code>	ID	ID of the dashboard page. Property behavior: - <i>read-only</i>
<code>name</code>	string	Dashboard page name.
<code>display_period</code>	integer	Default: empty string. Dashboard page display period (in seconds). Possible values: 0, 10, 30, 60, 120, 600, 1800, 3600.
<code>widgets</code>	array	Default: 0 (will use the default page display period). Array of the template dashboard widget objects.

Template dashboard widget

The template dashboard widget object has the following properties.

Property	Type	Description
widgetid	ID	ID of the dashboard widget.
type	string	<p>Property behavior: - <i>read-only</i></p> <p>Type of the dashboard widget.</p> <p>Possible values: actionlog - Action log; clock - Clock; discovery - Discovery status; favgraphs - Favorite graphs; favmaps - Favorite maps; gauge - Gauge; graph - Graph (classic); graphprototype - Graph prototype; honeycomb - Honeycomb; hostavail - Host availability; hostcard - Host card; hostnavigator - Host navigator; itemnavigator - Item navigator; item - Item value; map - Map; navtree - Map Navigation Tree; piechart - Pie chart; plaintext - Plain text; problemhosts - Problem hosts; problems - Problems; problemsbysv - Problems by severity; slareport - SLA report; svggraph - Graph; systeminfo - System information; tophosts - Top hosts; topitems - Top items; toptriggers - Top triggers; trigover - Trigger overview; url - URL; web - Web monitoring.</p> <p>Property behavior: - <i>required</i></p>
name	string	Custom widget name.
x	integer	A horizontal position from the left side of the dashboard.
y	integer	<p>Possible values range from 0 to 71. A vertical position from the top of the dashboard.</p>
width	integer	<p>Possible values range from 0 to 63. The widget width.</p>
height	integer	<p>Possible values range from 1 to 72. The widget height.</p>
view_mode	integer	<p>Possible values range from 1 to 64. The widget view mode.</p>
fields	array	<p>Possible values: 0 - (<i>default</i>) default widget view; 1 - with hidden header;</p> <p>Array of the template dashboard widget field objects.</p>

The template dashboard widget field object has the following properties.

Property	Type	Description
type	integer	Type of the widget field. Possible values: 0 - Integer; 1 - String; 4 - Item; 5 - Item prototype; 6 - Graph; 7 - Graph prototype; 8 - Map; 9 - Service; 10 - SLA; 11 - User; 12 - Action; 13 - Media type.
name	string	Property behavior: - <i>required</i> Widget field name. Possible values: see Dashboard widget fields . Note that some host-related parameters (e.g., <i>Host groups</i> , <i>Exclude host groups</i> and <i>Hosts</i> in the Problems widget, <i>Host groups</i> in the Host availability widget, etc.) are not available when configuring the widget on a template dashboard. This is because template dashboards display data only from the host that the template is linked to.
value	mixed	Property behavior: - <i>required</i> Widget field value depending on the type. Possible values: see Dashboard widget fields . Note that some host-related parameters (e.g., <i>Host groups</i> , <i>Exclude host groups</i> and <i>Hosts</i> in the Problems widget, <i>Host groups</i> in the Host availability widget, etc.) are not available when configuring the widget on a template dashboard. This is because template dashboards display data only from the host that the template is linked to. Property behavior: - <i>required</i>

templatedashboard.create

Description

object templatedashboard.create(object/array templateDashboards)

This method allows to create new template dashboards.

Note:

This method is only available to *Admin* and *Super admin* user types. Permissions to call the method can be revoked in user role settings. See **User roles** for more information.

Parameters

(object/array) Template dashboards to create.

Additionally to the **standard template dashboard properties**, the method accepts the following parameters.

Parameter	Type	Description
pages	array	<p>Template dashboard pages to be created for the dashboard. Dashboard pages will be ordered in the same order as specified.</p> <p>Parameter behavior: - <i>required</i></p>

Return values

(object) Returns an object containing the IDs of the created template dashboards under the `dashboardids` property. The order of the returned IDs matches the order of the passed template dashboards.

Examples

Creating a template dashboard

Create a template dashboard named "Graphs" with one Graph widget on a single dashboard page.

Request:

```
{
  "jsonrpc": "2.0",
  "method": "templatedashboard.create",
  "params": {
    "templateid": "10318",
    "name": "Graphs",
    "pages": [
      {
        "widgets": [
          {
            "type": "graph",
            "x": 0,
            "y": 0,
            "width": 12,
            "height": 5,
            "view_mode": 0,
            "fields": [
              {
                "type": 6,
                "name": "graphid",
                "value": "1123"
              }
            ]
          }
        ]
      }
    ]
  }
},
"id": 1
}
```

Response:

```
{
  "jsonrpc": "2.0",
  "result": {
    "dashboardids": [
      "32"
    ]
  },
  "id": 1
}
```

See also

- [Template dashboard page](#)
- [Template dashboard widget](#)
- [Template dashboard widget field](#)

Source

CTemplateDashboard::create() in *ui/include/classes/api/services/CTemplateDashboard.php*.

templatedashboard.delete

Description

object templatedashboard.delete(array templateDashboardIds)

This method allows to delete template dashboards.

Note:

This method is only available to *Admin* and *Super admin* user types. Permissions to call the method can be revoked in user role settings. See [User roles](#) for more information.

Parameters

(array) IDs of the template dashboards to delete.

Return values

(object) Returns an object containing the IDs of the deleted template dashboards under the `dashboardids` property.

Examples

Deleting multiple template dashboards

Delete two template dashboards.

Request:

```
{
  "jsonrpc": "2.0",
  "method": "templatedashboard.delete",
  "params": [
    "45",
    "46"
  ],
  "id": 1
}
```

Response:

```
{
  "jsonrpc": "2.0",
  "result": {
    "dashboardids": [
      "45",
      "46"
    ]
  },
  "id": 1
}
```

Source

CTemplateDashboard::delete() in *ui/include/classes/api/services/CTemplateDashboard.php*.

templatedashboard.get

Description

integer/array templatedashboard.get(object parameters)

The method allows to retrieve template dashboards according to the given parameters.

Note:

This method is available to users of any type. Permissions to call the method can be revoked in user role settings. See [User roles](#) for more information.

Parameters

(object) Parameters defining the desired output.

The method supports the following parameters.

Parameter	Type	Description
dashboardids	ID/array	Return only template dashboards with the given IDs.
templateids	ID/array	Return only template dashboards that belong to the given templates.
selectPages	query	Return a <code>pages</code> property with template dashboard pages, correctly ordered.
sortfield	string/array	Sort the result by the given properties.
countOutput	boolean	Possible values: <code>dashboardid</code> , <code>name</code> . These parameters being common for all get methods are described in detail in the reference commentary .
editable	boolean	
excludeSearch	boolean	
filter	object	
limit	integer	
output	query	
preservekeys	boolean	
search	object	
searchByAny	boolean	
searchWildcardsEnabled	boolean	
sortorder	string/array	
startSearch	boolean	

Return values

(integer/array) Returns either:

- an array of objects;
- the count of retrieved objects, if the `countOutput` parameter has been used.

Examples**Retrieving template dashboards**

Retrieve all template dashboards with widgets for a specified template.

Request:

```
{
  "jsonrpc": "2.0",
  "method": "templatedashboard.get",
  "params": {
    "output": "extend",
    "selectPages": "extend",
    "templateids": "10001"
  },
  "id": 1
}
```

Response:

```
{
  "jsonrpc": "2.0",
  "result": [
    {
      "dashboardid": "23",
      "name": "Docker overview",
    }
  ]
}
```

```

"templateid": "10001",
"display_period": "30",
"auto_start": "1",
"uuid": "6dfcbe0bc5ad400ea9c1c2dd7649282f",
"pages": [
  {
    "dashboard_pageid": "1",
    "name": "",
    "display_period": "0",
    "widgets": [
      {
        "widgetid": "220",
        "type": "graph",
        "name": "",
        "x": "0",
        "y": "0",
        "width": "36",
        "height": "5",
        "view_mode": "0",
        "fields": [
          {
            "type": "6",
            "name": "graphid",
            "value": "1125"
          }
        ]
      },
      {
        "widgetid": "221",
        "type": "graph",
        "name": "",
        "x": "12",
        "y": "0",
        "width": "36",
        "height": "5",
        "view_mode": "0",
        "fields": [
          {
            "type": "6",
            "name": "graphid",
            "value": "1129"
          }
        ]
      },
      {
        "widgetid": "222",
        "type": "graph",
        "name": "",
        "x": "0",
        "y": "5",
        "width": "36",
        "height": "5",
        "view_mode": "0",
        "fields": [
          {
            "type": "6",
            "name": "graphid",
            "value": "1128"
          }
        ]
      }
    ]
  },
  {

```

```

        "widgetid": "223",
        "type": "graph",
        "name": "",
        "x": "12",
        "y": "5",
        "width": "36",
        "height": "5",
        "view_mode": "0",
        "fields": [
            {
                "type": "6",
                "name": "graphid",
                "value": "1126"
            }
        ]
    },
    {
        "widgetid": "224",
        "type": "graph",
        "name": "",
        "x": "0",
        "y": "10",
        "width": "36",
        "height": "5",
        "view_mode": "0",
        "fields": [
            {
                "type": "6",
                "name": "graphid",
                "value": "1127"
            }
        ]
    }
]
},
],
"id": 1
}

```

See also

- [Template dashboard page](#)
- [Template dashboard widget](#)
- [Template dashboard widget field](#)

Source

CTemplateDashboard::get() in *ui/include/classes/api/services/CTemplateDashboard.php*.

templatedashboard.update

Description

object templatedashboard.update(object/array templateDashboards)

This method allows to update existing template dashboards.

Note:

This method is only available to *Admin* and *Super admin* user types. Permissions to call the method can be revoked in user role settings. See [User roles](#) for more information.

Parameters

(object/array) Template dashboard properties to be updated.

The dashboardid property must be specified for each dashboard, all other properties are optional. Only the specified properties will be updated.

Additionally to the [standard template dashboard properties](#), the method accepts the following parameters.

Parameter	Type	Description
pages	array	<p>Template dashboard pages to replace the existing dashboard pages.</p> <p>Dashboard pages are updated by the dashboard_pageid property. New dashboard pages will be created for objects without dashboard_pageid property and the existing dashboard pages will be deleted if not reused. Dashboard pages will be ordered in the same order as specified. Only the specified properties of the dashboard pages will be updated. At least one dashboard page object is required for pages property.</p>

Return values

(object) Returns an object containing the IDs of the updated template dashboards under the dashboardids property.

Examples

Renaming a template dashboard

Rename a template dashboard to "Performance graphs".

Request:

```
{
  "jsonrpc": "2.0",
  "method": "templatedashboard.update",
  "params": {
    "dashboardid": "23",
    "name": "Performance graphs"
  },
  "id": 1
}
```

Response:

```
{
  "jsonrpc": "2.0",
  "result": {
    "dashboardids": [
      "23"
    ]
  },
  "id": 1
}
```

Updating template dashboard pages

Rename the first dashboard page, replace widgets on the second dashboard page and add a new page as the third one. Delete all other dashboard pages.

Request:

```
{
  "jsonrpc": "2.0",
  "method": "templatedashboard.update",
  "params": {
    "dashboardid": "2",
    "pages": [
      {
        "dashboard_pageid": 1,
        "name": "Renamed Page"
      }
    ]
  }
}
```

```

    },
    {
        "dashboard_pageid": 2,
        "widgets": [
            {
                "type": "clock",
                "x": 0,
                "y": 0,
                "width": 12,
                "height": 3
            }
        ]
    },
    {
        "display_period": 60
    }
]
},
{id": 1
}

```

Response:

```

{
    "jsonrpc": "2.0",
    "result": {
        "dashboardids": [
            "2"
        ]
    },
    "id": 1
}

```

See also

- [Template dashboard widget](#)
- [Template dashboard widget field](#)

Source

CTemplateDashboard::update() in *ui/include/classes/api/services/CTemplateDashboard.php*.

Template group

This class is designed to work with template groups.

Object references:

- [Template group](#)

Available methods:

- [templategroup.create](#) - create new template groups
- [templategroup.delete](#) - delete template groups
- [templategroup.get](#) - retrieve template groups
- [templategroup.massadd](#) - add related objects to template groups
- [templategroup.massremove](#) - remove related objects from template groups
- [templategroup.massupdate](#) - replace or remove related objects from template groups
- [templategroup.propagate](#) - propagate permissions to template groups' subgroups
- [templategroup.update](#) - update template groups

Template group object

The following objects are directly related to the `templategroup` API.

Template group

The template group object has the following properties.

Property	Type	Description
groupid	ID	ID of the template group.
name	string	<p>Property behavior:</p> <ul style="list-style-type: none">- <i>read-only</i>- <i>required</i> for update operations Name of the template group.
uuid	string	<p>Property behavior:</p> <ul style="list-style-type: none">- <i>required</i> for create operations Universal unique identifier, used for linking imported template groups to already existing ones. Auto-generated, if not given.

templategroup.create

Description

object templategroup.create(object/array templateGroups)

This method allows to create new template groups.

Note:

This method is only available to *Super admin* user type. Permissions to call the method can be revoked in user role settings. See [User roles](#) for more information.

Parameters

(object/array) Template groups to create. The method accepts template groups with the [standard template group properties](#).

Return values

(object) Returns an object containing the IDs of the created template groups under the `groupids` property. The order of the returned IDs matches the order of the passed template groups.

Examples

Creating a template group

Create a template group called "Templates/Databases".

Request:

```
{
  "jsonrpc": "2.0",
  "method": "templategroup.create",
  "params": {
    "name": "Templates/Databases"
  },
  "id": 1
}
```

Response:

```
{
  "jsonrpc": "2.0",
  "result": {
    "groupids": [
      "107820"
    ]
  },
  "id": 1
}
```

Source

CTemplateGroup::create() in `ui/include/classes/api/services/CTemplateGroup.php`.

templategroup.delete

Description

object templategroup.delete(array templateGroupIds)

This method allows to delete template groups.

A template group can not be deleted if it contains templates that belong to this group only.

Note:

This method is only available to *Admin* and *Super admin* user types. Permissions to call the method can be revoked in user role settings. See [User roles](#) for more information.

Parameters

(array) IDs of the template groups to delete.

Return values

(object) Returns an object containing the IDs of the deleted template groups under the `groupids` property.

Examples

Deleting multiple template groups

Delete two template groups.

Request:

```
{
  "jsonrpc": "2.0",
  "method": "templategroup.delete",
  "params": [
    "107814",
    "107815"
  ],
  "id": 1
}
```

Response:

```
{
  "jsonrpc": "2.0",
  "result": {
    "groupids": [
      "107814",
      "107815"
    ]
  },
  "id": 1
}
```

Source

CTemplateGroup::delete() in `ui/include/classes/api/services/CTemplateGroup.php`.

templategroup.get

Description

integer/array templategroup.get(object parameters)

The method allows to retrieve template groups according to the given parameters.

Note:

This method is available to users of any type. Permissions to call the method can be revoked in user role settings. See [User roles](#) for more information.

Parameters

(object) Parameters defining the desired output.

The method supports the following parameters.

Parameter	Type	Description
graphids	ID/array	Return only template groups that contain templates with the given graphs.
groupids	ID/array	Return only template groups with the given template group IDs.
templateids	ID/array	Return only template groups that contain the given templates.
triggerids	ID/array	Return only template groups that contain templates with the given triggers.
with_graphs	flag	Return only template groups that contain templates with graphs.
with_graph_prototypes	flag	Return only template groups that contain templates with graph prototypes.
with_httptests	flag	Return only template groups that contain templates with web checks.
with_items	flag	Return only template groups that contain templates with items.
with_item_prototypes	flag	Overrides the <code>with_simple_graph_items</code> parameters. Return only template groups that contain templates with item prototypes.
with_simple_graph_item_prototypes	flag	Overrides the <code>with_simple_graph_item_prototypes</code> parameter. Return only template groups that contain templates with item prototypes, which are enabled for creation and have numeric type of information.
with_simple_graph_items	flag	Return only template groups that contain templates with numeric items.
with_templates	flag	Return only template groups that contain templates.
with_triggers	flag	Return only template groups that contain templates with triggers.
selectTemplates	query	Return a <code>templates</code> property with the templates that belong to the template group.
limitSelects	integer	Supports <code>count</code> . Limits the number of records returned by subselects.
sortfield	string/array	Applies to the following subselects: <code>selectTemplates</code> - results will be sorted by <code>template</code> . Sort the result by the given properties.
countOutput	boolean	Possible values: <code>groupid</code> , <code>name</code> . These parameters being common for all <code>get</code> methods are described in detail in the reference commentary page.
editable	boolean	
excludeSearch	boolean	
filter	object	
limit	integer	
output	query	
preservekeys	boolean	
search	object	
searchByAny	boolean	
searchWildcardsEnabled	boolean	
sortorder	string/array	
startSearch	boolean	

Return values

(integer/array) Returns either:

- an array of objects;
- the count of retrieved objects, if the `countOutput` parameter has been used.

Examples

Retrieving data by name

Retrieve all data about two template groups named "Templates/Databases" and "Templates/Modules".

Request:

```
{
  "jsonrpc": "2.0",
  "method": "templategroup.get",
  "params": {
    "output": "extend",
    "filter": {
      "name": [
        "Templates/Databases",
        "Templates/Modules"
      ]
    }
  },
  "id": 1
}
```

Response:

```
{
  "jsonrpc": "2.0",
  "result": [
    {
      "groupid": "13",
      "name": "Templates/Databases",
      "uuid": "748ad4d098d447d492bb935c907f652f"
    },
    {
      "groupid": "8",
      "name": "Templates/Modules",
      "uuid": "57b7ae836ca64446ba2c296389c009b7"
    }
  ],
  "id": 1
}
```

See also

- [Template](#)

Source

CTemplateGroup::get() in `ui/include/classes/api/services/CTemplateGroup.php`.

templategroup.massadd

Description

object templategroup.massadd(object parameters)

This method allows to simultaneously add multiple related objects to all the given template groups.

Note:

This method is only available to *Admin* and *Super admin* user types. Permissions to call the method can be revoked in user role settings. See [User roles](#) for more information.

Parameters

(object) Parameters containing the IDs of the template groups to update and the objects to add to all the template groups.

The method accepts the following parameters.

Parameter	Type	Description
groups	object/array	<p>Template groups to be updated.</p> <p>The template groups must have only the <code>groupid</code> property defined.</p> <p>Parameter behavior: - <i>required</i></p>
templates	object/array	<p>Templates to add to all template groups.</p> <p>The templates must have only the <code>templateid</code> property defined.</p> <p>Parameter behavior: - <i>required</i></p>

Return values

(object) Returns an object containing the IDs of the updated template groups under the `groupids` property.

Examples

Adding templates to template groups

Add two templates to template groups with IDs 12 and 13.

Request:

```
{
  "jsonrpc": "2.0",
  "method": "templategroup.massadd",
  "params": {
    "groups": [
      {
        "groupid": "12"
      },
      {
        "groupid": "13"
      }
    ],
    "templates": [
      {
        "templateid": "10486"
      },
      {
        "templateid": "10487"
      }
    ]
  },
  "id": 1
}
```

Response:

```
{
  "jsonrpc": "2.0",
  "result": {
    "groupids": [
      "12",
      "13"
    ]
  },
  "id": 1
}
```

See also

- [Template](#)

Source

CTemplateGroup::massAdd() in *ui/include/classes/api/services/CTemplateGroup.php*.

templategroup.massremove

Description

object templategroup.massremove(object parameters)

This method allows to remove related objects from multiple template groups.

Note:

This method is only available to *Admin* and *Super admin* user types. Permissions to call the method can be revoked in user role settings. See [User roles](#) for more information.

Parameters

(object) Parameters containing the IDs of the template groups to update and the objects that should be removed.

Parameter	Type	Description
groupids	ID/array	IDs of the template groups to be updated. Parameter behavior: - <i>required</i>
templateids	ID/array	IDs of the templates to remove from all template groups. Parameter behavior: - <i>required</i>

Return values

(object) Returns an object containing the IDs of the updated template groups under the `groupids` property.

Examples

Removing templates from template groups

Remove two templates from the given template groups.

Request:

```
{
  "jsonrpc": "2.0",
  "method": "templategroup.massremove",
  "params": {
    "groupids": [
      "5",
      "6"
    ],
    "templateids": [
      "30050",
      "30001"
    ]
  },
  "id": 1
}
```

Response:

```
{
  "jsonrpc": "2.0",
  "result": {
    "groupids": [
      "5",
      "6"
    ]
  }
}
```



```

    ],
  },
  "id": 1
}

```

Source

CTemplateGroup::massRemove() in *ui/include/classes/api/services/CTemplateGroup.php*.

templategroup.massupdate

Description

object templategroup.massupdate(object parameters)

This method allows to replace templates with the specified ones in multiple template groups.

Note:

This method is only available to *Admin* and *Super admin* user types. Permissions to call the method can be revoked in user role settings. See [User roles](#) for more information.

Parameters

(object) Parameters containing the IDs of the template groups to update and the objects that should be updated.

Parameter	Type	Description
groups	object/array	<p>Template groups to be updated.</p> <p>The template groups must have only the <code>groupid</code> property defined.</p> <p>Parameter behavior: - <i>required</i></p>
templates	object/array	<p>Templates to replace the current template on the given template groups.</p> <p>All other template, except the ones mentioned, will be excluded from template groups.</p> <p>The templates must have only the <code>templateid</code> property defined.</p> <p>Parameter behavior: - <i>required</i></p>

Return values

(object) Returns an object containing the IDs of the updated template groups under the `groupids` property.

Examples

Replacing templates in a template group

Replace all templates in a template group to ones mentioned templates.

Request:

```

{
  "jsonrpc": "2.0",
  "method": "templategroup.massupdate",
  "params": {
    "groups": [
      {
        "groupid": "8"
      }
    ],
    "templates": [
      {

```

```

        "templateid": "40050"
    }
    ],
},
"id": 1
}

```

Response:

```

{
  "jsonrpc": "2.0",
  "result": {
    "groupids": [
      "8",
    ]
  },
  "id": 1
}

```

See also

- [templategroup.update](#)
- [templategroup.massadd](#)
- [Template](#)

Source

CTemplateGroup::massUpdate() in `ui/include/classes/api/services/CTemplateGroup.php`.

templategroup.propagate

Description

object `templategroup.propagate(object parameters)`

This method allows to apply permissions to all template groups' subgroups.

Note:

This method is only available to *Super admin* user types. Permissions to call the method can be revoked in user role settings. See [User roles](#) for more information.

Parameters

(object) Parameters defining the desired output.

The method supports the following parameters.

Parameter	Type	Description
groups	object/array	<p>Template groups to propagate.</p> <p>The template groups must have only the <code>groupid</code> property defined.</p> <p>Parameter behavior: - <i>required</i></p>
permissions	boolean	<p>Set true if need to propagate permissions.</p> <p>Parameter behavior: - <i>required</i></p>

Return values

(object) Returns an object containing the IDs of the propagated template groups under the `groupids` property.

Examples

Propagating template group permissions to its subgroups.

Propagate template group permissions to its subgroups.

Request:

```
{
  "jsonrpc": "2.0",
  "method": "templategroup.propagate",
  "params": {
    "groups": [
      {
        "groupid": "15"
      }
    ],
    "permissions": true
  },
  "id": 1
}
```

Response:

```
{
  "jsonrpc": "2.0",
  "result": {
    "groupids": [
      "15",
    ]
  },
  "id": 1
}
```

See also

- [templategroup.update](#)
- [templategroup.massadd](#)
- [Template](#)

Source

CTemplateGroup::propagate() in *ui/include/classes/api/services/CTemplateGroup.php*.

templategroup.update

Description

object templategroup.update(object/array templateGroups)

This method allows to update existing template groups.

Note:

This method is only available to *Admin* and *Super admin* user types. Permissions to call the method can be revoked in user role settings. See [User roles](#) for more information.

Parameters

(object/array) **Template group properties** to be updated.

The `groupid` property must be defined for each template group, all other properties are optional. Only the given properties will be updated, all others will remain unchanged.

Return values

(object) Returns an object containing the IDs of the updated template groups under the `groupids` property.

Examples

Renaming a template group

Rename a template group to "Templates/Databases"

Request:

```
{
  "jsonrpc": "2.0",
  "method": "templategroup.update",
  "params": {
    "groupid": "7",
    "name": "Templates/Databases"
  },
  "id": 1
}
```

Response:

```
{
  "jsonrpc": "2.0",
  "result": {
    "groupids": [
      "7"
    ]
  },
  "id": 1
}
```

Source

CTemplateGroup::update() in *ui/include/classes/api/services/CTemplateGroup.php*.

Token

This class is designed to work with tokens.

Object references:

- [Token](#)

Available methods:

- [token.create](#) - create new tokens
- [token.delete](#) - delete tokens
- [token.get](#) - retrieve tokens
- [token.update](#) - update tokens
- [token.generate](#) - generate tokens

Token object

The following objects are directly related to the token API.

Token

The token object has the following properties.

Property	Type	Description
tokenid	ID	ID of the token.
name	string	<p>Property behavior:</p> <ul style="list-style-type: none"> - <i>read-only</i> - <i>required</i> for update operations Name of the token.
description	text	<p>Property behavior:</p> <ul style="list-style-type: none"> - <i>required</i> for create operations Description of the token.

Property	Type	Description
userid	ID	ID of the user that the token has been assigned to. Default: <i>current user</i> .
lastaccess	timestamp	Most recent date and time the token was authenticated. "0" if the token has never been authenticated.
status	integer	Token status. Possible values: 0 - (<i>default</i>) enabled token; 1 - disabled token.
expires_at	timestamp	Token expiration date and time. "0" for never-expiring tokens.
created_at	timestamp	Token creation date and time.
creator_userid	ID	ID of the user that created the token. Property behavior: - <i>read-only</i>
		Property behavior: - <i>read-only</i>

token.create

Description

object token.create(object/array tokens)

This method allows to create new tokens.

Note:

The *Manage API tokens permission* is required for the user role to manage tokens for other users.

Attention:

A token created by this method also has to be **generated** before it is usable.

Parameters

(object/array) Tokens to create.

The method accepts tokens with the **standard token properties**.

Return values

(object) Returns an object containing the IDs of the created tokens under the `tokenids` property. The order of the returned IDs matches the order of the passed tokens.

Examples

Create a token

Create an enabled token that never expires and authenticates user of ID 2.

Request:

```
{
  "jsonrpc": "2.0",
  "method": "token.create",
```

```
"params": {
  "name": "Your token",
  "userid": "2"
},
"id": 1
}
```

Response:

```
{
  "jsonrpc": "2.0",
  "result": {
    "tokenids": [
      "188"
    ]
  },
  "id": 1
}
```

Create a disabled token that expires at January 21st, 2021. This token will authenticate current user.

Request:

```
{
  "jsonrpc": "2.0",
  "method": "token.create",
  "params": {
    "name": "Your token",
    "status": "1",
    "expires_at": "1611238072"
  },
  "id": 1
}
```

Response:

```
{
  "jsonrpc": "2.0",
  "result": {
    "tokenids": [
      "189"
    ]
  },
  "id": 1
}
```

Source

CToken::create() in *ui/include/classes/api/services/CToken.php*.

token.delete

Description

object token.delete(array tokenids)

This method allows to delete tokens.

Note:

The *Manage API tokens permission* is required for the user role to manage tokens for other users.

Parameters

(array) IDs of the tokens to delete.

Return values

(object) Returns an object containing the IDs of the deleted tokens under the `tokenids` property.

Examples

Delete multiple tokens

Delete two tokens.

Request:

```
{
  "jsonrpc": "2.0",
  "method": "token.delete",
  "params": [
    "188",
    "192"
  ],
  "id": 1
}
```

Response:

```
{
  "jsonrpc": "2.0",
  "result": {
    "tokenids": [
      "188",
      "192"
    ]
  },
  "id": 1
}
```

Source

CToken::delete() in *ui/include/classes/api/services/CToken.php*.

token.generate

Description

object token.generate(array tokenids)

This method allows to generate tokens.

Note:

The *Manage API tokens permission* is required for the user role to manage tokens for other users.

Attention:

A token can be generated by this method only if it has been **created**.

Parameters

(array) IDs of the tokens to generate.

Return values

(array) Returns an array of objects containing the ID of the generated token under the `tokenid` property and generated authorization string under `token` property.

Property	Type	Description
tokenid	ID	ID of the token.
token	string	The generated authorization string for this token.

Examples

Generate multiple tokens

Generate two tokens.

Request:

```
{
  "jsonrpc": "2.0",
  "method": "token.generate",
  "params": [
    "1",
    "2"
  ],
  "id": 1
}
```

Response:

```
{
  "jsonrpc": "2.0",
  "result": [
    {
      "tokenid": "1",
      "token": "bbcfce79a2d95037502f7e9a534906d3466c9a1484beb6ea0f4e7be28e8b8ce2"
    },
    {
      "tokenid": "2",
      "token": "fa1258a83d518eabd87698a96bd7f07e5a6ae8aeb8463cae33d50b91dd21bd6d"
    }
  ],
  "id": 1
}
```

Source

CToken::generate() in `ui/include/classes/api/services/CToken.php`.

token.get

Description

integer/array token.get(object parameters)

The method allows to retrieve tokens according to the given parameters.

Note:

Only *Super admin* user type is allowed to view tokens for other users.

Parameters

(object) Parameters defining the desired output.

The method supports the following parameters.

Parameter	Type	Description
tokenids	ID/array	Return only tokens with the given IDs.
usersids	ID/array	Return only tokens created for the given users.
token	string	Return only tokens created for the given <i>Auth token</i> .
valid_at	timestamp	Return only tokens, which are valid (not expired) at the given date and time.
expired_at	timestamp	Return only tokens, which are expired (not valid) at the given date and time.
sortfield	string/array	Sort the result by the given properties. Possible values: <code>tokenid</code> , <code>name</code> , <code>lastaccess</code> , <code>status</code> , <code>expires_at</code> , <code>created_at</code> .
countOutput	boolean	These parameters being common for all get methods are described in detail in the reference commentary .
excludeSearch	boolean	
filter	object	

Parameter	Type	Description
limit	integer	
output	query	
preservekeys	boolean	
search	object	
searchByAny	boolean	
searchWildcardsEnabled	boolean	
sortorder	string/array	
startSearch	boolean	

Return values

(integer/array) Returns either:

- an array of objects;
- the count of retrieved objects, if the `countOutput` parameter has been used.

Examples

Retrieve a token

Retrieve all data for the token with ID "2".

Request:

```
{
  "jsonrpc": "2.0",
  "method": "token.get",
  "params": {
    "output": "extend",
    "tokenids": "2"
  },
  "id": 1
}
```

Response:

```
{
  "jsonrpc": "2.0",
  "result": [
    {
      "tokenid": "1",
      "name": "The Token",
      "description": "",
      "userid": "1",
      "lastaccess": "0",
      "status": "0",
      "expires_at": "1609406220",
      "created_at": "1611239454",
      "creator_userid": "1"
    }
  ],
  "id": 1
}
```

Source

`CToken::get()` in `ui/include/classes/api/services/CToken.php`.

token.update

Description

`object token.update(object/array tokens)`

This method allows to update existing tokens.

Note:

The *Manage API tokens* **permission** is required for the user role to manage tokens for other users.

Parameters

(object/array) Token properties to be updated.

The `tokenId` property must be defined for each token, all other properties are optional. Only the passed properties will be updated, all others will remain unchanged.

The method accepts tokens with the **standard token properties**.

Return values

(object) Returns an object containing the IDs of the updated tokens under the `tokenids` property.

Examples

Remove token expiry

Remove expiry date from token.

Request:

```
{
  "jsonrpc": "2.0",
  "method": "token.update",
  "params": {
    "tokenId": "2",
    "expires_at": "0"
  },
  "id": 1
}
```

Response:

```
{
  "jsonrpc": "2.0",
  "result": {
    "tokenids": [
      "2"
    ]
  },
  "id": 1
}
```

Source

CToken::update() in *ui/include/classes/api/services/CToken.php*.

Trend

This class is designed to work with trend data.

Object references:

- **Float trend**
- **Integer trend**

Available methods:

- **trend.get** - retrieve trends

Trend object

The following objects are directly related to the `trend` API.

Note:

Trend objects differ depending on the item's type of information. They are created by the Zabbix server and cannot be modified via the API.

Float trend

The float trend object has the following properties.

Property	Type	Description
clock	timestamp	Timestamp of an hour for which the value was calculated. For example, timestamp of "04:00:00" means values calculated for period "04:00:00-04:59:59".
itemid	ID	ID of the related item.
num	integer	Number of values that were available for the hour.
value_min	float	Hourly minimum value.
value_avg	float	Hourly average value.
value_max	float	Hourly maximum value.

Integer trend

The integer trend object has the following properties.

Property	Type	Description
clock	timestamp	Timestamp of an hour for which the value was calculated. For example, timestamp of "04:00:00" means values calculated for period "04:00:00-04:59:59".
itemid	ID	ID of the related item.
num	integer	Number of values that were available for the hour.
value_min	integer	Hourly minimum value.
value_avg	integer	Hourly average value.
value_max	integer	Hourly maximum value.

trend.get**Description**

`integer/array trend.get(object parameters)`

The method allows to retrieve trend data according to the given parameters.

Note:

This method is available to users of any type. Permissions to call the method can be revoked in user role settings. See [User roles](#) for more information.

Parameters

(object) Parameters defining the desired output.

The method supports the following parameters.

Parameter	Type	Description
itemids	ID/array	Return only trends with the given item IDs.
time_from	timestamp	Return only values that have been collected after or at the given time.
time_till	timestamp	Return only values that have been collected before or at the given time.
countOutput	boolean	Count the number of retrieved objects.
limit	integer	Limit the amount of retrieved objects.
output	query	Set Trend object properties to be returned.

Return values

(integer/array) Returns either:

- an array of objects;
- the count of retrieved objects, if the `countOutput` parameter has been used.

Examples

Retrieving item trend data

Request:

```
{
  "jsonrpc": "2.0",
  "method": "trend.get",
  "params": {
    "output": [
      "itemid",
      "clock",
      "num",
      "value_min",
      "value_avg",
      "value_max",
    ],
    "itemids": [
      "23715"
    ],
    "limit": "1"
  },
  "id": 1
}
```

Response:

```
{
  "jsonrpc": "2.0",
  "result": [
    {
      "itemid": "23715",
      "clock": "1446199200",
      "num": "60",
      "value_min": "0.165",
      "value_avg": "0.2168",
      "value_max": "0.35",
    }
  ],
  "id": 1
}
```

Source

`CTrend::get()` in `ui/include/classes/api/services/CTrend.php`.

Trigger

This class is designed to work with triggers.

Object references:

- [Trigger](#)
- [Trigger tag](#)

Available methods:

- `trigger.create` - create new triggers
- `trigger.delete` - delete triggers
- `trigger.get` - retrieve triggers
- `trigger.update` - update triggers

Trigger object

The following objects are directly related to the `trigger` API.

Trigger

The trigger object has the following properties.

Property	Type	Description
<code>triggerid</code>	ID	ID of the trigger.
<code>description</code>	string	<p>Property behavior:</p> <ul style="list-style-type: none"> - <i>read-only</i> - <i>required</i> for update operations Name of the trigger.
<code>expression</code>	string	<p>Property behavior:</p> <ul style="list-style-type: none"> - <i>required</i> for create operations Reduced trigger expression.
<code>event_name</code>	string	<p>Property behavior:</p> <ul style="list-style-type: none"> - <i>required</i> for create operations Event name generated by the trigger.
<code>opdata</code>	string	Operational data.
<code>comments</code>	string	Additional description of the trigger.
<code>error</code>	string	Error text if there have been any problems when updating the state of the trigger.
<code>flags</code>	integer	<p>Property behavior:</p> <ul style="list-style-type: none"> - <i>read-only</i> Origin of the trigger. Possible values: <ul style="list-style-type: none"> 0 - (<i>default</i>) a plain trigger; 4 - a discovered trigger.
<code>lastchange</code>	timestamp	<p>Property behavior:</p> <ul style="list-style-type: none"> - <i>read-only</i> Time when the trigger last changed its state.
<code>priority</code>	integer	<p>Property behavior:</p> <ul style="list-style-type: none"> - <i>read-only</i> Severity of the trigger. Possible values: <ul style="list-style-type: none"> 0 - (<i>default</i>) not classified; 1 - information; 2 - warning; 3 - average; 4 - high; 5 - disaster.
<code>state</code>	integer	State of the trigger. Possible values: <ul style="list-style-type: none"> 0 - (<i>default</i>) trigger state is up to date; 1 - current trigger state is unknown.
<code>status</code>	integer	<p>Property behavior:</p> <ul style="list-style-type: none"> - <i>read-only</i> Whether the trigger is enabled or disabled. Possible values: <ul style="list-style-type: none"> 0 - (<i>default</i>) enabled; 1 - disabled.

Property	Type	Description
templateid	ID	ID of the parent template trigger.
type	integer	<p>Property behavior: - <i>read-only</i></p> <p>Whether the trigger can generate multiple problem events.</p> <p>Possible values: 0 - (<i>default</i>) do not generate multiple events; 1 - generate multiple events.</p>
url	string	URL associated with the trigger.
url_name	string	Label for the URL associated with the trigger.
value	integer	<p>Whether the trigger is in OK or problem state.</p> <p>Possible values: 0 - (<i>default</i>) OK; 1 - problem.</p> <p>Property behavior: - <i>read-only</i></p>
recovery_mode	integer	<p>OK event generation mode.</p> <p>Possible values: 0 - (<i>default</i>) Expression; 1 - Recovery expression; 2 - None.</p>
recovery_expression	string	Reduced trigger recovery expression.
correlation_mode	integer	<p>OK event closes.</p> <p>Possible values: 0 - (<i>default</i>) All problems; 1 - All problems if tag values match.</p>
correlation_tag	string	Tag for matching.
manual_close	integer	<p>Allow manual close.</p> <p>Possible values: 0 - (<i>default</i>) No; 1 - Yes.</p>
uuid	string	<p>Universal unique identifier, used for linking imported triggers to already existing ones. Auto-generated, if not given.</p> <p>Property behavior: - <i>supported</i> if the trigger belongs to a template</p>

Trigger tag

The trigger tag object has the following properties.

Property	Type	Description
tag	string	<p>Trigger tag name.</p> <p>Property behavior: - <i>required</i></p>
value	string	Trigger tag value.

trigger.create

Description

```
object trigger.create(object/array triggers)
```

This method allows to create new triggers.

Note:

This method is only available to *Admin* and *Super admin* user types. Permissions to call the method can be revoked in user role settings. See [User roles](#) for more information.

Parameters

(object/array) Triggers to create.

Additionally to the [standard trigger properties](#) the method accepts the following parameters.

Parameter	Type	Description
dependencies	array	Triggers that the trigger is dependent on.
tags	array	The triggers must have only the <code>triggerid</code> property defined. Trigger tags .

Attention:

The trigger expression has to be given in its expanded form.

Return values

(object) Returns an object containing the IDs of the created triggers under the `triggerids` property. The order of the returned IDs matches the order of the passed triggers.

Examples

Creating a trigger

Create a trigger with a single trigger dependency.

Request:

```
{
  "jsonrpc": "2.0",
  "method": "trigger.create",
  "params": [
    {
      "description": "Processor load is too high on {HOST.NAME}",
      "expression": "last(/Linux server/system.cpu.load[percpu,avg1])>5",
      "dependencies": [
        {
          "triggerid": "17367"
        }
      ]
    },
    {
      "description": "Service status",
      "expression": "length(last(/Linux server/log[/var/log/system,Service .* has stopped]))<>0",
      "dependencies": [
        {
          "triggerid": "17368"
        }
      ],
      "tags": [
        {
          "tag": "service",
          "value": "{{ITEM.VALUE}.regsub(\"Service (.*) has stopped\", \"\\1\")}"
        },
        {
          "tag": "error",
          "value": ""
        }
      ]
    }
  ]
}
```

```
    ],
    "id": 1
}
```

Response:

```
{
  "jsonrpc": "2.0",
  "result": {
    "triggerids": [
      "17369",
      "17370"
    ]
  },
  "id": 1
}
```

Source

CTrigger::create() in `ui/include/classes/api/services/CTrigger.php`.

trigger.delete

Description

object trigger.delete(array triggerIds)

This method allows to delete triggers.

Note:

This method is only available to *Admin* and *Super admin* user types. Permissions to call the method can be revoked in user role settings. See [User roles](#) for more information.

Parameters

(array) IDs of the triggers to delete.

Return values

(object) Returns an object containing the IDs of the deleted triggers under the `triggerids` property.

Examples

Delete multiple triggers

Delete two triggers.

Request:

```
{
  "jsonrpc": "2.0",
  "method": "trigger.delete",
  "params": [
    "12002",
    "12003"
  ],
  "id": 1
}
```

Response:

```
{
  "jsonrpc": "2.0",
  "result": {
    "triggerids": [
      "12002",
      "12003"
    ]
  },
}
```



```
"id": 1  
}
```

Source

CTrigger::delete() in *ui/include/classes/api/services/CTrigger.php*.

trigger.get

Description

integer/array trigger.get(object parameters)

The method allows to retrieve triggers according to the given parameters.

Note:

This method is available to users of any type. Permissions to call the method can be revoked in user role settings. See [User roles](#) for more information.

Parameters

(object) Parameters defining the desired output.

The method supports the following parameters.

Parameter	Type	Description
triggerids	ID/array	Return only triggers with the given IDs.
groupids	ID/array	Return only triggers that belong to hosts or templates from the given host groups or template groups.
templateids	ID/array	Return only triggers that belong to the given templates.
hostids	ID/array	Return only triggers that belong to the given hosts.
itemids	ID/array	Return only triggers that contain the given items.
functions	string/array	Return only triggers that use the given functions.
group	string	Refer to the supported function page for a list of supported functions. Return only triggers that belong to hosts or templates from the host group or template group with the given name.
host	string	Return only triggers that belong to host with the given technical name.
inherited	boolean	If set to <code>true</code> return only triggers inherited from a template.
templated	boolean	If set to <code>true</code> return only triggers that belong to templates.
dependent	boolean	If set to <code>true</code> return only triggers that have dependencies. If set to <code>false</code> return only triggers that do not have dependencies.
monitored	flag	Return only enabled triggers that belong to monitored hosts and contain only enabled items.
active	flag	Return only enabled triggers that belong to monitored hosts.
maintenance	boolean	If set to <code>true</code> return only enabled triggers that belong to hosts in maintenance.
withUnacknowledgedEvents	flag	Return only triggers that have unacknowledged events.
withAcknowledgedEvents	flag	Return only triggers with all events acknowledged.
withLastEventUnacknowledged	flag	Return only triggers with the last event unacknowledged.
skipDependent	flag	Skip triggers in a problem state that are dependent on other triggers. Note that the other triggers are ignored if disabled, have disabled items or disabled item hosts.
lastChangeSince	timestamp	Return only triggers that have changed their state after the given time.
lastChangeTill	timestamp	Return only triggers that have changed their state before the given time.
only_true	flag	Return only triggers that have recently been in a problem state.
min_severity	integer	Return only triggers with severity greater or equal than the given severity.
evaltype	integer	Rules for tag searching.

Possible values:

0 - (default) And/Or;
2 - Or.

Parameter	Type	Description
tags	array	<p>Return only triggers with given tags. Exact match by tag and case-sensitive or case-insensitive search by tag value depending on operator value.</p> <p>Format: [{"tag": "<tag>", "value": "<value>", "operator": "<operator>"}, ...].</p> <p>An empty array returns all triggers.</p> <p>Possible operator types:</p> <ul style="list-style-type: none"> 0 - (default) Like; 1 - Equal; 2 - Not like; 3 - Not equal; 4 - Exists; 5 - Not exists.
expandComment	flag	Expand macros in the trigger description.
expandDescription	flag	Expand macros in the name of the trigger.
expandExpression	flag	Expand functions and macros in the trigger expression.
selectHostGroups	query	Return the host groups that the trigger belongs to in the hostgroups property.
selectHosts	query	Return the hosts that the trigger belongs to in the hosts property.
selectItems	query	Return items contained by the trigger in the items property.
selectFunctions	query	Return functions used in the trigger in the functions property.
		<p>The function objects represent the functions used in the trigger expression and has the following properties:</p> <ul style="list-style-type: none"> functionid - (ID) ID of the function; itemid - (ID) ID of the item used in the function; function - (string) name of the function; parameter - (string) parameter passed to the function. Query parameter is replaced by \$ symbol in returned string.
selectDependencies	query	Return triggers that the trigger depends on in the dependencies property.
selectDiscoveryRule	query	Return the low-level discovery rule that created the trigger in the discoveryRule property.
selectLastEvent	query	Return the last significant trigger event in the lastEvent property.
selectTags	query	Return the trigger tags in tags property.
selectTemplateGroups	query	Return the template groups that the trigger belongs to in the templategroups property.
selectTriggerDiscovery	query	Return the trigger discovery object in the triggerDiscovery property. The trigger discovery objects link the trigger to a trigger prototype from which it was created.
		<p>It has the following properties:</p> <ul style="list-style-type: none"> parent_triggerid - (ID) ID of the trigger prototype from which the trigger has been created; status - (int) trigger discovery status: <ul style="list-style-type: none"> 0 - (default) trigger is discovered, 1 - trigger is not discovered anymore; ts_delete - (timestamp) time when a trigger that is no longer discovered will be deleted; ts_disable - (timestamp) time when a trigger that is no longer discovered will be disabled; disable_source - (int) indicator of whether trigger was disabled by an LLD rule or manually: <ul style="list-style-type: none"> 0 - (default) disabled automatically, 1 - disabled by an LLD rule.

Parameter	Type	Description
filter	object	Return only those results that exactly match the given filter. Accepts an object, where the keys are property names, and the values are either a single value or an array of values to match against. Does not support properties of text data type . Supports additional properties: host - technical name of the host that the trigger belongs to; hostid - ID of the host that the trigger belongs to.
limitSelects	integer	Limits the number of records returned by subselects.
sortfield	string/array	Applies to the following subselects: selectHosts - results will be sorted by host. Sort the result by the given properties. Possible values: triggerid, description, status, priority, lastchange, hostname.
countOutput	boolean	These parameters being common for all get methods are described in detail in the reference commentary page.
editable	boolean	
excludeSearch	boolean	
limit	integer	
output	query	
preservekeys	boolean	
search	object	
searchByAny	boolean	
searchWildcardsEnabled	boolean	
sortorder	string/array	
startSearch	boolean	

Return values

(integer/array) Returns either:

- an array of objects;
- the count of retrieved objects, if the countOutput parameter has been used.

Examples

Retrieving data by trigger ID

Retrieve all data and the functions used in trigger "14062".

Request:

```
{
  "jsonrpc": "2.0",
  "method": "trigger.get",
  "params": {
    "triggerids": "14062",
    "output": "extend",
    "selectFunctions": "extend"
  },
  "id": 1
}
```

Response:

```
{
  "jsonrpc": "2.0",
  "result": [
    {
      "triggerid": "14062",
      "expression": "{13513}<10m",
    }
  ]
}
```

```

        "description": "{HOST.NAME} has been restarted (uptime < 10m)",
        "url": "",
        "status": "0",
        "value": "0",
        "priority": "2",
        "lastchange": "0",
        "comments": "The host uptime is less than 10 minutes",
        "error": "",
        "templateid": "10016",
        "type": "0",
        "state": "0",
        "flags": "0",
        "recovery_mode": "0",
        "recovery_expression": "",
        "correlation_mode": "0",
        "correlation_tag": "",
        "manual_close": "0",
        "opdata": "",
        "event_name": "",
        "uuid": "",
        "url_name": "",
        "functions": [
            {
                "functionid": "13513",
                "itemid": "24350",
                "triggerid": "14062",
                "parameter": "$",
                "function": "last"
            }
        ]
    },
    "id": 1
}

```

Retrieving triggers in problem state

Retrieve the ID, name and severity of all triggers in problem state and sort them by severity in descending order.

Request:

```

{
  "jsonrpc": "2.0",
  "method": "trigger.get",
  "params": {
    "output": [
      "triggerid",
      "description",
      "priority"
    ],
    "filter": {
      "value": 1
    },
    "sortfield": "priority",
    "sortorder": "DESC"
  },
  "id": 1
}

```

Response:

```

{
  "jsonrpc": "2.0",
  "result": [
    {

```

```

        "triggerid": "13907",
        "description": "Zabbix self-monitoring processes < 100% busy",
        "priority": "4"
    },
    {
        "triggerid": "13824",
        "description": "Zabbix discoverer processes more than 75% busy",
        "priority": "3"
    }
],
"id": 1
}

```

Retrieving a specific trigger with tags

Retrieve a specific trigger with tags.

Request:

```

{
  "jsonrpc": "2.0",
  "method": "trigger.get",
  "params": {
    "output": [
      "triggerid",
      "description"
    ],
    "selectTags": "extend",
    "triggerids": [
      "17578"
    ]
  },
  "id": 1
}

```

Response:

```

{
  "jsonrpc": "2.0",
  "result": [
    {
      "triggerid": "17370",
      "description": "Service status",
      "tags": [
        {
          "tag": "service",
          "value": "{{ITEM.VALUE}}.regex(\\"Service (.*) has stopped\\", \\"\\1\\")"
        },
        {
          "tag": "error",
          "value": ""
        }
      ]
    }
  ],
  "id": 1
}

```

See also

- [Discovery rule](#)
- [Item](#)
- [Host](#)
- [Host group](#)
- [Template group](#)

Source

CTrigger::get() in `ui/include/classes/api/services/CTrigger.php`.

trigger.update

Description

object `trigger.update(object/array triggers)`

This method allows to update existing triggers.

Note:

This method is only available to *Admin* and *Super admin* user types. Permissions to call the method can be revoked in user role settings. See [User roles](#) for more information.

Parameters

(object/array) Trigger properties to be updated.

The `triggerid` property must be defined for each trigger, all other properties are optional. Only the passed properties will be updated, all others will remain unchanged.

Additionally to the [standard trigger properties](#) the method accepts the following parameters.

Parameter	Type	Description
<code>dependencies</code>	array	Triggers that the trigger is dependent on.
<code>tags</code>	array	The triggers must have only the <code>triggerid</code> property defined. Trigger tags .

Attention:

The trigger expression has to be given in its expanded form.

Return values

(object) Returns an object containing the IDs of the updated triggers under the `triggerids` property.

Examples

Enabling a trigger

Enable a trigger, that is, set its status to "0".

Request:

```
{
  "jsonrpc": "2.0",
  "method": "trigger.update",
  "params": {
    "triggerid": "13938",
    "status": 0
  },
  "id": 1
}
```

Response:

```
{
  "jsonrpc": "2.0",
  "result": {
    "triggerids": [
      "13938"
    ]
  },
  "id": 1
}
```

Replacing triggers tags

Replace tags for trigger.

Request:

```
{
  "jsonrpc": "2.0",
  "method": "trigger.update",
  "params": {
    "triggerid": "13938",
    "tags": [
      {
        "tag": "service",
        "value": "{ITEM.VALUE}.regex(\"Service (.*) has stopped\", \"\\1\")"
      },
      {
        "tag": "error",
        "value": ""
      }
    ]
  },
  "id": 1
}
```

Response:

```
{
  "jsonrpc": "2.0",
  "result": {
    "triggerids": [
      "13938"
    ]
  },
  "id": 1
}
```

Replacing dependencies

Replace dependencies for trigger.

Request:

```
{
  "jsonrpc": "2.0",
  "method": "trigger.update",
  "params": {
    "triggerid": "22713",
    "dependencies": [
      {
        "triggerid": "22712"
      },
      {
        "triggerid": "22772"
      }
    ]
  },
  "id": 1
}
```

Response:

```
{
  "jsonrpc": "2.0",
  "result": {
    "triggerids": [
      "22713"
    ]
  }
}
```

```

    },
    "id": 1
}

```

Source

CTrigger::update() in *ui/include/classes/api/services/CTrigger.php*.

Trigger prototype

This class is designed to work with trigger prototypes.

Object references:

- [Trigger prototype](#)
- [Trigger prototype tag](#)

Available methods:

- [triggerprototype.create](#) - create new trigger prototypes
- [triggerprototype.delete](#) - delete trigger prototypes
- [triggerprototype.get](#) - retrieve trigger prototypes
- [triggerprototype.update](#) - update trigger prototypes

Trigger prototype object

The following objects are directly related to the `triggerprototype` API.

Trigger prototype

The trigger prototype object has the following properties.

Property	Type	Description
triggerid	ID	ID of the trigger prototype.
		Property behavior: - <i>read-only</i>
description	string	- <i>required</i> for update operations Name of the trigger prototype.
		Property behavior: - <i>required</i> for create operations
expression	string	Reduced trigger expression.
		Property behavior: - <i>required</i> for create operations
event_name	string	Event name generated by the trigger.
opdata	string	Operational data.
comments	string	Additional comments to the trigger prototype.
priority	integer	Severity of the trigger prototype.
		Possible values: 0 - (<i>default</i>) not classified; 1 - information; 2 - warning; 3 - average; 4 - high; 5 - disaster.
status	integer	Whether the trigger prototype is enabled or disabled.
		Possible values: 0 - (<i>default</i>) enabled; 1 - disabled.

Property	Type	Description
templateid	ID	ID of the parent template trigger prototype.
type	integer	<p>Property behavior: - <i>read-only</i></p> <p>Whether the trigger prototype can generate multiple problem events.</p> <p>Possible values: 0 - (<i>default</i>) do not generate multiple events; 1 - generate multiple events.</p>
url	string	URL associated with the trigger prototype.
url_name	string	Label for the URL associated with the trigger prototype.
recovery_mode	integer	<p>OK event generation mode.</p> <p>Possible values: 0 - (<i>default</i>) Expression; 1 - Recovery expression; 2 - None.</p>
recovery_expression	string	Reduced trigger recovery expression.
correlation_mode	integer	<p>OK event closes.</p> <p>Possible values: 0 - (<i>default</i>) All problems; 1 - All problems if tag values match.</p>
correlation_tag	string	Tag for matching.
manual_close	integer	Allow manual close.
discover	integer	<p>Possible values: 0 - (<i>default</i>) No; 1 - Yes.</p> <p>Trigger prototype discovery status.</p> <p>Possible values: 0 - (<i>default</i>) new triggers will be discovered; 1 - new triggers will not be discovered and existing triggers will be marked as lost.</p>
uuid	string	<p>Universal unique identifier, used for linking imported trigger prototypes to already existing ones. Auto-generated, if not given.</p> <p>Property behavior: - <i>supported</i> if the trigger prototype belongs to a template</p>

Trigger prototype tag

The trigger prototype tag object has the following properties.

Property	Type	Description
tag	string	Trigger prototype tag name.
value	string	<p>Property behavior: - <i>required</i></p> <p>Trigger prototype tag value.</p>

triggerprototype.create

Description

object triggerprototype.create(object/array triggerPrototypes)

This method allows to create new trigger prototypes.

Note:

This method is only available to *Admin* and *Super admin* user types. Permissions to call the method can be revoked in user role settings. See [User roles](#) for more information.

Parameters

(object/array) Trigger prototypes to create.

Additionally to the [standard trigger prototype properties](#) the method accepts the following parameters.

Parameter	Type	Description
dependencies	array	Triggers and trigger prototypes that the trigger prototype is dependent on.
tags	array	The triggers must have only the triggerid property defined. Trigger prototype tags.

Attention:

The trigger expression has to be given in its expanded form and must contain at least one item prototype.

Return values

(object) Returns an object containing the IDs of the created trigger prototypes under the triggerids property. The order of the returned IDs matches the order of the passed trigger prototypes.

Examples**Creating a trigger prototype**

Create a trigger prototype to detect when a file system has less than 20% free disk space.

Request:

```
{
  "jsonrpc": "2.0",
  "method": "triggerprototype.create",
  "params": {
    "description": "Free disk space is less than 20% on volume {#FSNAME}",
    "expression": "last(/Zabbix server/vfs.fs.size[{#FSNAME},pfree])<20",
    "tags": [
      {
        "tag": "volume",
        "value": "{#FSNAME}"
      },
      {
        "tag": "type",
        "value": "{#FSTYPE}"
      }
    ]
  },
  "id": 1
}
```

Response:

```
{
  "jsonrpc": "2.0",
  "result": {
    "triggerids": [
      "17372"
    ]
  },
  "id": 1
}
```

Source

CTriggerPrototype::create() in *ui/include/classes/api/services/CTriggerPrototype.php*.

triggerprototype.delete

Description

object triggerprototype.delete(array triggerPrototypeIds)

This method allows to delete trigger prototypes.

Note:

This method is only available to *Admin* and *Super admin* user types. Permissions to call the method can be revoked in user role settings. See [User roles](#) for more information.

Parameters

(array) IDs of the trigger prototypes to delete.

Return values

(object) Returns an object containing the IDs of the deleted trigger prototypes under the `triggerids` property.

Examples

Deleting multiple trigger prototypes

Delete two trigger prototypes.

Request:

```
{
  "jsonrpc": "2.0",
  "method": "triggerprototype.delete",
  "params": [
    "12002",
    "12003"
  ],
  "id": 1
}
```

Response:

```
{
  "jsonrpc": "2.0",
  "result": {
    "triggerids": [
      "12002",
      "12003"
    ]
  },
  "id": 1
}
```

Source

CTriggerPrototype::delete() in *ui/include/classes/api/services/CTriggerPrototype.php*.

triggerprototype.get

Description

integer/array triggerprototype.get(object parameters)

The method allows to retrieve trigger prototypes according to the given parameters.

Note:

This method is available to users of any type. Permissions to call the method can be revoked in user role settings. See [User roles](#) for more information.

Parameters

(object) Parameters defining the desired output.

The method supports the following parameters.

Parameter	Type	Description
active	flag	Return only enabled trigger prototypes that belong to monitored hosts.
discoveryids	ID/array	Return only trigger prototypes that belong to the given LLD rules.
functions	string/array	Return only triggers that use the given functions.
group	string	Refer to the Supported functions page for a list of supported functions. Return only trigger prototypes that belong to hosts or templates from the host groups or template groups with the given name.
groupids	ID/array	Return only trigger prototypes that belong to hosts or templates from the given host groups or template groups.
host	string	Return only trigger prototypes that belong to hosts with the given name.
hostids	ID/array	Return only trigger prototypes that belong to the given hosts.
inherited	boolean	If set to <code>true</code> return only trigger prototypes inherited from a template.
maintenance	boolean	If set to <code>true</code> return only enabled trigger prototypes that belong to hosts in maintenance.
min_severity	integer	Return only trigger prototypes with severity greater or equal than the given severity.
monitored	flag	Return only enabled trigger prototypes that belong to monitored hosts and contain only enabled items.
templated	boolean	If set to <code>true</code> return only trigger prototypes that belong to templates.
templateids	ID/array	Return only trigger prototypes that belong to the given templates.
triggerids	ID/array	Return only trigger prototypes with the given IDs.
expandExpression	flag	Expand functions and macros in the trigger expression.
selectDependencies	query	Return trigger prototypes and triggers that the trigger prototype depends on in the <code>dependencies</code> property.
selectDiscoveryRule	query	Return the LLD rule that the trigger prototype belongs to in the <code>discoveryRule</code> property.
selectFunctions	query	Return functions used in the trigger prototype in the <code>functions</code> property.
selectHostGroups	query	The function objects represent the functions used in the trigger expression and has the following properties: <code>functionid</code> - (ID) ID of the function; <code>itemid</code> - (ID) ID of the item used in the function; <code>function</code> - (string) name of the function; <code>parameter</code> - (string) parameter passed to the function. Query parameter is replaced by <code>\$</code> symbol in returned string. Return the host groups that the trigger prototype belongs to in the <code>hostgroups</code> property.
selectHosts	query	Return the hosts that the trigger prototype belongs to in the <code>hosts</code> property.
selectItems	query	Return items and item prototypes used the trigger prototype in the <code>items</code> property.
selectTags	query	Return the trigger prototype tags in <code>tags</code> property.
selectTemplateGroups	query	Return the template groups that the trigger prototype belongs to in the <code>templategroups</code> property.

Parameter	Type	Description
filter	object	Return only those results that exactly match the given filter. Accepts an object, where the keys are property names, and the values are either a single value or an array of values to match against. Does not support properties of text data type . Supports additional properties: host - technical name of the host that the trigger prototype belongs to; hostid - ID of the host that the trigger prototype belongs to.
limitSelects	integer	Limits the number of records returned by subselects.
sortfield	string/array	Applies to the following subselects: selectHosts - results will be sorted by host. Sort the result by the given properties.
countOutput	boolean	Possible values: triggerid, description, status, priority. These parameters being common for all get methods are described in detail in the reference commentary .
editable	boolean	
excludeSearch	boolean	
limit	integer	
output	query	
preservekeys	boolean	
search	object	
searchByAny	boolean	
searchWildcardsEnabled	boolean	
sortorder	string/array	
startSearch	boolean	

Return values

(integer/array) Returns either:

- an array of objects;
- the count of retrieved objects, if the countOutput parameter has been used.

Examples

Retrieve trigger prototypes from an LLD rule

Retrieve all trigger prototypes and their functions from an LLD rule.

Request:

```
{
  "jsonrpc": "2.0",
  "method": "triggerprototype.get",
  "params": {
    "output": "extend",
    "selectFunctions": "extend",
    "discoveryids": "22450"
  },
  "id": 1
}
```

Response:

```
{
  "jsonrpc": "2.0",
  "result": [
    {
      "triggerid": "13272",
      "expression": "{12598}<20",
      "description": "Free inodes is less than 20% on volume {#FSNAME}",
    }
  ]
}
```

```

"url": "",
"status": "0",
"value": "0",
"priority": "2",
"lastchange": "0",
"comments": "",
"error": "",
"templateid": "0",
"type": "0",
"state": "0",
"flags": "2",
"recovery_mode": "0",
"recovery_expression": "",
"correlation_mode": "0",
"correlation_tag": "",
"manual_close": "0",
"opdata": "",
"discover": "0",
"event_name": "",
"uuid": "6ce467d05e8745409a177799bed34bb3",
"url_name": "",
"functions": [
  {
    "functionid": "12598",
    "itemid": "22454",
    "triggerid": "13272",
    "parameter": "$",
    "function": "last"
  }
]
},
{
  "triggerid": "13266",
  "expression": "{13500}<20",
  "description": "Free disk space is less than 20% on volume {#FSNAME}",
  "url": "",
  "status": "0",
  "value": "0",
  "priority": "2",
  "lastchange": "0",
  "comments": "",
  "error": "",
  "templateid": "0",
  "type": "0",
  "state": "0",
  "flags": "2",
  "recovery_mode": "0",
  "recovery_expression": "",
  "correlation_mode": "0",
  "correlation_tag": "",
  "manual_close": "0",
  "opdata": "",
  "discover": "0",
  "event_name": "",
  "uuid": "74a1fc62bfe24b7eabe4e244c70dc384",
  "url_name": "",
  "functions": [
    {
      "functionid": "13500",
      "itemid": "22686",
      "triggerid": "13266",
      "parameter": "$",
    }
  ]
}

```

```

        "function": "last"
    }
    ]
},
"id": 1
}

```

Retrieving a specific trigger prototype with tags

Request:

```

{
  "jsonrpc": "2.0",
  "method": "triggerprototype.get",
  "params": {
    "output": [
      "triggerid",
      "description"
    ],
    "selectTags": "extend",
    "triggerids": [
      "17373"
    ]
  },
  "id": 1
}

```

Response:

```

{
  "jsonrpc": "2.0",
  "result": [
    {
      "triggerid": "17373",
      "description": "Free disk space is less than 20% on volume {#FSNAME}",
      "tags": [
        {
          "tag": "volume",
          "value": "{#FSNAME}"
        },
        {
          "tag": "type",
          "value": "{#FSTYPE}"
        }
      ]
    }
  ],
  "id": 1
}

```

See also

- [Discovery rule](#)
- [Item](#)
- [Host](#)
- [Host group](#)
- [Template group](#)

Source

CTriggerPrototype::get() in *ui/include/classes/api/services/CTriggerPrototype.php*.

triggerprototype.update

Description

object triggerprototype.update(object/array triggerPrototypes)

This method allows to update existing trigger prototypes.

Note:

This method is only available to *Admin* and *Super admin* user types. Permissions to call the method can be revoked in user role settings. See [User roles](#) for more information.

Parameters

(object/array) Trigger prototype properties to be updated.

The `triggerid` property must be defined for each trigger prototype, all other properties are optional. Only the passed properties will be updated, all others will remain unchanged.

Additionally to the [standard trigger prototype properties](#) the method accepts the following parameters.

Parameter	Type	Description
dependencies	array	Triggers and trigger prototypes that the trigger prototype is dependent on.
tags	array	The triggers must have only the <code>triggerid</code> property defined. Trigger prototype tags.

Attention:

The trigger expression has to be given in its expanded form and must contain at least one item prototype.

Return values

(object) Returns an object containing the IDs of the updated trigger prototypes under the `triggerids` property.

Examples

Enabling a trigger prototype

Enable a trigger prototype, that is, set its status to "0".

Request:

```
{
  "jsonrpc": "2.0",
  "method": "triggerprototype.update",
  "params": {
    "triggerid": "13938",
    "status": 0
  },
  "id": 1
}
```

Response:

```
{
  "jsonrpc": "2.0",
  "result": {
    "triggerids": [
      "13938"
    ]
  },
  "id": 1
}
```

Replacing trigger prototype tags

Replace tags for one trigger prototype.

Request:

```

{
  "jsonrpc": "2.0",
  "method": "triggerprototype.update",
  "params": {
    "triggerid": "17373",
    "tags": [
      {
        "tag": "volume",
        "value": "{#FSNAME}"
      },
      {
        "tag": "type",
        "value": "{#FSTYPE}"
      }
    ]
  },
  "id": 1
}

```

Response:

```

{
  "jsonrpc": "2.0",
  "result": {
    "triggerids": [
      "17373"
    ]
  },
  "id": 1
}

```

Source

CTriggerPrototype::update() in *ui/include/classes/api/services/CTriggerPrototype.php*.

User

This class is designed to work with users.

Object references:

- [User](#)
- [Media](#)

Available methods:

- [user.checkauthentication](#) - check and prolong user sessions
- [user.create](#) - create new users
- [user.delete](#) - delete users
- [user.get](#) - retrieve users
- [user.login](#) - log in to the API
- [user.logout](#) - log out of the API
- [user.provision](#) - provision LDAP users
- [user.resettotp](#) - reset user TOTP secrets
- [user.unblock](#) - unblock users
- [user.update](#) - update users

User object

The following objects are directly related to the user API.

User

The user object has the following properties.

Property	Type	Description
userid	ID	ID of the user.
username	string	<p>Property behavior:</p> <ul style="list-style-type: none"> - <i>read-only</i> - <i>required</i> for update operations <p>User's name.</p> <p>Property behavior:</p> <ul style="list-style-type: none"> - <i>required</i> for create operations - <i>read-only</i> for provisioned users if the user is linked to a user directory (<code>userdirectoryid</code> is set to a valid value that is not "0"), and user directory provisioning status is enabled (<code>provision_status</code> of User directory object is set to "1"), and authentication status of all LDAP or SAML provisioning is enabled (<code>ldap_jit_status</code> of Authentication object is set to "Enabled for configured LDAP IdPs" or <code>saml_jit_status</code> of Authentication object is set to "Enabled for configured SAML IdPs")
passwd	string	<p>User's password.</p> <p>The value of this parameter can be an empty string if the user is linked to a user directory.</p> <p>Property behavior:</p> <ul style="list-style-type: none"> - <i>write-only</i>
roleid	ID	<p>ID of the role of the user.</p> <p>Note that users without a role can log into Zabbix only using LDAP or SAML authentication, provided their LDAP/SAML information matches the user group mappings configured in Zabbix.</p>
attempt_clock	timestamp	Time of the last unsuccessful login attempt.
attempt_failed	integer	<p>Property behavior:</p> <ul style="list-style-type: none"> - <i>read-only</i> <p>Recent failed login attempt count.</p> <p>Property behavior:</p> <ul style="list-style-type: none"> - <i>read-only</i>
attempt_ip	string	<p>IP address from where the last unsuccessful login attempt came from.</p> <p>Property behavior:</p> <ul style="list-style-type: none"> - <i>read-only</i>
autologin	integer	<p>Whether to enable auto-login.</p> <p>Possible values:</p> <ul style="list-style-type: none"> 0 - (<i>default</i>) auto-login disabled; 1 - auto-login enabled.
autologout	string	<p>User session life time. Accepts seconds and time unit with suffix. If set to 0s, the session will never expire.</p> <p>Default: 15m.</p>
lang	string	<p>Language code of the user's language, for example, <code>en_US</code>.</p> <p>Default: <code>default</code> - system default.</p>
name	string	Name of the user.
refresh	string	<p>Automatic refresh period. Accepts seconds or time unit with suffix (e.g., 30s, 90s, 1m, 1h).</p> <p>Default: 30s.</p>
rows_per_page	integer	<p>Amount of object rows to show per page.</p> <p>Default: 50.</p>

Property	Type	Description
surname	string	Surname of the user.
theme	string	User's theme. Possible values: default - (<i>default</i>) system default; blue-theme - Blue; dark-theme - Dark.
ts_provisioned	timestamp	Time when the latest provisioning operation was made.
url	string	URL of the page to redirect the user to after logging in.
userdirectoryid	ID	ID of the user directory that the user is linked to. Used for provisioning (creating or updating), as well as to login a user that is linked to a user directory. For login operations the value of this property will have priority over the userdirectoryid property of user groups that the user belongs to. Default: 0. Property behavior: - <i>read-only</i>
timezone	string	User's time zone, for example, Europe/London, UTC. Default: default - system default. For the full list of supported time zones please refer to PHP documentation .

Media

The media object has the following properties.

Property	Type	Description
mediatypeid	ID	ID of the media type used by the media.
sendto	string/array	Property behavior: - <i>required</i> Address, user name or other identifier of the recipient. If type of Media type is set to "Email", values are represented as array. For other types of Media types , value is represented as a string.
active	integer	Property behavior: - <i>required</i> Whether the media is enabled. Possible values: 0 - (<i>default</i>) enabled; 1 - disabled.

Property	Type	Description
severity	integer	<p>Trigger severities to send notifications about.</p> <p>Possible bitmap values: 1 - Not classified; 2 - Information; 4 - Warning; 8 - Average; 16 - High; 32 - Disaster.</p> <p>This is a bitmask field; any sum of possible bitmap values is acceptable (for example, 48 for Average, High, and Disaster).</p>
period	string	<p>Default: 63.</p> <p>Time when the notifications can be sent as a time period or user macros separated by a semicolon.</p>
userdirectory_mediaid	ID	<p>Default: 1-7,00:00-24:00.</p> <p>User directory media mapping ID for provisioned media.</p> <p>Property behavior: - <i>read-only</i></p>

user.checkAuthentication

Description

object `user.checkAuthentication`

This method checks and prolongs the user session.

Attention:

Calling the `user.checkAuthentication` method using the parameter `sessionid` prolongs the user session by default.

Parameters

The method accepts the following parameters.

Parameter	Type	Description
extend	boolean	<p>Whether to prolong the user session.</p> <p>Default value: "true". Setting the value to "false" allows to check the user session without prolonging it.</p> <p>Parameter behavior: - <i>supported</i> if <code>sessionid</code> is set</p>
sessionid	string	<p>User authentication token.</p> <p>Parameter behavior: - <i>required</i> if <code>token</code> is not set</p>
secret	string	<p>Random 32 characters string. Is generated on user login.</p>
token	string	<p>User API token.</p> <p>Parameter behavior: - <i>required</i> if <code>sessionid</code> is not set</p>

Return values

(object) Returns an object containing information about the user.

Additionally to the [standard user properties](#), the following information is returned.

Property	Type	Description
auth_type	integer	Default authentication for the user. Refer to the <code>authentication_type</code> property of the Authentication object for a list of possible values.
debug_mode	integer	Whether debug mode is enabled or disabled for the user. Refer to the <code>debug_mode</code> property of the User group object for a list of possible values.
deprovisioned	boolean	Whether the user belongs to a deprovisioned users group .
gui_access	string	User's authentication method to the frontend. Refer to the <code>gui_access</code> property of the User group object for a list of possible values.
secret	string	Random 32 characters string. Is generated on user login. Property <code>secret</code> is not returned if the user session is checked using an API token.
sessionid	string	Authentication token, which must be used in the following API requests. Property <code>sessionid</code> is not returned if the user session is checked using an API token.
type	integer	User type. Refer to the <code>type</code> property of the Role object for a list of possible values.
userip	string	IP address of the user.

Examples

Check authentication using authentication token

Check and prolong a user session using the user authentication token, and return additional information about the user.

Request:

```
{
  "jsonrpc": "2.0",
  "method": "user.checkAuthentication",
  "params": {
    "sessionid": "673b8ba11562a35da902c66cf5c23fa2"
  },
  "id": 1
}
```

Response:

```
{
  "jsonrpc": "2.0",
  "result": {
    "userid": "1",
    "username": "Admin",
    "name": "Zabbix",
    "surname": "Administrator",
    "url": "",
    "autologin": "1",
    "autologout": "0",
    "lang": "ru_RU",
    "refresh": "0",
    "theme": "default",
    "attempt_failed": "0",
    "attempt_ip": "127.0.0.1",
  }
}
```

```

    "attempt_clock": "1355919038",
    "rows_per_page": "50",
    "timezone": "Europe/Riga",
    "roleid": "3",
    "userdirectoryid": "0",
    "ts_provisioned": "0",
    "type": 3,
    "userip": "127.0.0.1",
    "debug_mode": 0,
    "gui_access": "0",
    "deprovisioned": false,
    "auth_type": 0,
    "sessionid": "673b8ba11562a35da902c66cf5c23fa2",
    "secret": "0e329b933e46984e49a5c1051ecd0751"
  },
  "id": 1
}

```

Check authentication using API token

Check a user session using the user API token, and return additional information about the user.

Request:

```

{
  "jsonrpc": "2.0",
  "method": "user.checkAuthentication",
  "params": {
    "token": "00aff470e07c12d707e50d98cfe39edef9e6ec349c14728dbdfbc8ddc5ea3eae"
  },
  "id": 1
}

```

Response:

```

{
  "jsonrpc": "2.0",
  "result": {
    "userid": "1",
    "username": "Admin",
    "name": "Zabbix",
    "surname": "Administrator",
    "url": "",
    "autologin": "1",
    "autologout": "0",
    "lang": "ru_RU",
    "refresh": "0",
    "theme": "default",
    "attempt_failed": "0",
    "attempt_ip": "127.0.0.1",
    "attempt_clock": "1355919338",
    "rows_per_page": "50",
    "timezone": "Europe/Riga",
    "roleid": "3",
    "userdirectoryid": "0",
    "ts_provisioned": "0",
    "type": 3,
    "userip": "127.0.0.1",
    "debug_mode": 0,
    "gui_access": "1",
    "deprovisioned": false,
    "auth_type": 0
  },
  "id": 1
}

```

Source

CUser::checkAuthentication() in *ui/include/classes/api/services/CUser.php*.

user.create

Description

object user.create(object/array users)

This method allows to create new users.

Note:

This method is only available to *Super admin* user type. Permissions to call the method can be revoked in user role settings. See [User roles](#) for more information.

Note:

The strength of user password is validated according the password policy rules defined by Authentication API. See [Authentication API](#) for more information.

Parameters

(object/array) Users to create.

Additionally to the [standard user properties](#), the method accepts the following parameters.

Parameter	Type	Description
usrgrps	array	User groups to add the user to. The user groups must have only the <code>usrgrpid</code> property defined.
medias	array	User media to be created.

Return values

(object) Returns an object containing the IDs of the created users under the `userids` property. The order of the returned IDs matches the order of the passed users.

Examples

Creating a user

Create a new user, add him to a user group and create a new media for him.

Request:

```
{
  "jsonrpc": "2.0",
  "method": "user.create",
  "params": {
    "username": "John",
    "passwd": "Doe123",
    "roleid": "5",
    "usrgrps": [
      {
        "usrgrpid": "7"
      }
    ],
    "medias": [
      {
        "mediatypeid": "1",
        "sendto": [
          "support@company.com"
        ],
        "active": 0,
        "severity": 63,
        "period": "1-7,00:00-24:00"
      }
    ]
  }
}
```

```
    }
  ],
  "id": 1
}
```

Response:

```
{
  "jsonrpc": "2.0",
  "result": {
    "userids": [
      "12"
    ]
  },
  "id": 1
}
```

See also

- [Authentication](#)
- [Media](#)
- [User group](#)
- [Role](#)

Source

CUser::create() in `ui/include/classes/api/services/CUser.php`.

user.delete

Description

object user.delete(array users)

This method allows to delete users.

Note:

This method is only available to *Super admin* user type. Permissions to call the method can be revoked in user role settings. See [User roles](#) for more information.

Parameters

(array) IDs of users to delete.

Return values

(object) Returns an object containing the IDs of the deleted users under the `userids` property.

Examples

Deleting multiple users

Delete two users.

Request:

```
{
  "jsonrpc": "2.0",
  "method": "user.delete",
  "params": [
    "1",
    "5"
  ],
  "id": 1
}
```

Response:

```

{
  "jsonrpc": "2.0",
  "result": {
    "userids": [
      "1",
      "5"
    ]
  },
  "id": 1
}

```

Source

CUser::delete() in *ui/include/classes/api/services/CUser.php*.

user.get

Description

integer/array user.get(object parameters)

The method allows to retrieve users according to the given parameters.

Note:

This method is available to users of any type. Permissions to call the method can be revoked in user role settings. See [User roles](#) for more information.

Parameters

(object) Parameters defining the desired output.

The method supports the following parameters.

Parameter	Type	Description
mediaids	ID/array	Return only users that use the given media.
mediatypeids	ID/array	Return only users that use the given media types.
userids	ID/array	Return only users with the given IDs.
usrgrpids	ID/array	Return only users that belong to the given user groups.
getAccess	flag	Adds additional information about user permissions.
		Adds the following properties for each user: <i>gui_access</i> - (integer) user's frontend authentication method. Refer to the <i>gui_access</i> property of the user group object for a list of possible values. <i>debug_mode</i> - (integer) indicates whether debug is enabled for the user. Possible values: 0 - debug disabled, 1 - debug enabled. <i>users_status</i> - (integer) indicates whether the user is disabled. Possible values: 0 - user enabled, 1 - user disabled.
selectMedias	query	Return media used by the user in the medias property.
selectMediatypes	query	Return media types used by the user in the mediatypes property.
		See mediatype.get for restrictions based on user type.
selectUsrgrps	query	Return user groups that the user belongs to in the usrgrps property.
selectRole	query	Return user role in the role property.
sortfield	string/array	Sort the result by the given properties.
		Possible values: <i>userid</i> , <i>username</i> .
countOutput	boolean	These parameters being common for all get methods are described in detail in the reference commentary .
editable	boolean	
excludeSearch	boolean	
filter	object	
limit	integer	
output	query	

Parameter	Type	Description
preservekeys	boolean	
search	object	
searchByAny	boolean	
searchWildcardsEnabled	boolean	
sortorder	string/array	
startSearch	boolean	

Return values

(integer/array) Returns either:

- an array of objects;
- the count of retrieved objects, if the `countOutput` parameter has been used.

Examples

Retrieving users

Retrieve all of the configured users.

Request:

```
{
  "jsonrpc": "2.0",
  "method": "user.get",
  "params": {
    "output": "extend"
  },
  "id": 1
}
```

Response:

```
{
  "jsonrpc": "2.0",
  "result": [
    {
      "userid": "1",
      "username": "Admin",
      "name": "Zabbix",
      "surname": "Administrator",
      "url": "",
      "autologin": "1",
      "autologout": "0",
      "lang": "en_US",
      "refresh": "0s",
      "theme": "default",
      "attempt_failed": "0",
      "attempt_ip": "",
      "attempt_clock": "0",
      "rows_per_page": "50",
      "timezone": "default",
      "roleid": "3",
      "userdirectoryid": "0",
      "ts_provisioned": "0"
    },
    {
      "userid": "2",
      "username": "guest",
      "name": "",
      "surname": "",
      "url": "",
      "autologin": "0",
      "autologout": "15m",
      "lang": "default",

```

```

        "refresh": "30s",
        "theme": "default",
        "attempt_failed": "0",
        "attempt_ip": "",
        "attempt_clock": "0",
        "rows_per_page": "50",
        "timezone": "default",
        "roleid": "4",
        "userdirectoryid": "0",
        "ts_provisioned": "0"
    },
    {
        "userid": "3",
        "username": "user",
        "name": "Zabbix",
        "surname": "User",
        "url": "",
        "autologin": "0",
        "autologout": "0",
        "lang": "ru_RU",
        "refresh": "15s",
        "theme": "dark-theme",
        "attempt_failed": "0",
        "attempt_ip": "",
        "attempt_clock": "0",
        "rows_per_page": "100",
        "timezone": "default",
        "roleid": "1",
        "userdirectoryid": "0",
        "ts_provisioned": "0"
    }
],
    "id": 1
}

```

Retrieving user data

Retrieve data of a user with ID "12".

Request:

```

{
    "jsonrpc": "2.0",
    "method": "user.get",
    "params": {
        "output": ["userid", "username"],
        "selectRole": "extend",
        "userids": "12"
    },
    "id": 1
}

```

Response:

```

{
    "jsonrpc": "2.0",
    "result": [
        {
            "userid": "12",
            "username": "John",
            "role": {
                "roleid": "5",
                "name": "Operator",
                "type": "1",
                "readonly": "0"
            }
        }
    ]
}

```

```

    }
  }
],
"id": 1
}

```

See also

- [Media](#)
- [Media type](#)
- [User group](#)
- [Role](#)

Source

CUser::get() in `ui/include/classes/api/services/CUser.php`.

user.login

Description

`string/object user.login(object parameters)`

This method allows to log in to the API and generate an authentication token.

Warning:

When using this method, you also need to do `user.logout` to prevent the generation of a large number of open session records.

Attention:

This method is only available to unauthenticated users who do not belong to any `user group` with enabled multi-factor authentication.

Parameters

(object) Parameters containing the user name and password.

The method accepts the following parameters.

Parameter	Type	Description
password	string	User password. Parameter behavior: - <i>required</i>
username	string	User name. Parameter behavior: - <i>required</i>
userData	flag	Return information about the authenticated user.

Return values

(string/object) If the `userData` parameter is used, returns an object containing information about the authenticated user.

Additionally to the [standard user properties](#), the following information is returned:

Property	Type	Description
auth_type	integer	Default authentication for the user. Refer to the <code>authentication_type</code> property of the Authentication object for a list of possible values.
debug_mode	integer	Whether debug mode is enabled or disabled for the user. Refer to the <code>debug_mode</code> property of the User group object for a list of possible values.
deprovisioned	boolean	Whether the user belongs to a deprovisioned users group .

Property	Type	Description
gui_access	string	User's authentication method to the frontend. Refer to the <code>gui_access</code> property of the <code>User group object</code> for a list of possible values.
mfaid	integer	ID of the <code>MFA method</code> to use for the user during login. Returns "0" if MFA is disabled globally or for all user groups that the user belongs to.
secret	string	Random 32 characters string. Is generated on user login.
sessionid	string	Authentication token, which must be used in the following API requests.
type	integer	User type. Refer to the <code>type</code> property of the <code>Role object</code> for a list of possible values.
userip	string	IP address of the user.

Note:

If a user has been successfully authenticated after one or more failed attempts, the method will return the current values for the `attempt_clock`, `attempt_failed` and `attempt_ip` properties and then reset them.

If the `userData` parameter is not used, the method returns an authentication token that is required for `authentication`.

Examples

Authenticating a user

Authenticate a user.

Request:

```
{
  "jsonrpc": "2.0",
  "method": "user.login",
  "params": {
    "username": "Admin",
    "password": "zabbix"
  },
  "id": 1
}
```

Response:

```
{
  "jsonrpc": "2.0",
  "result": "0424bd59b807674191e7d77572075f33",
  "id": 1
}
```

Requesting authenticated user's information

Authenticate and return additional information about the user.

Request:

```
{
  "jsonrpc": "2.0",
  "method": "user.login",
  "params": {
    "username": "Admin",
    "password": "zabbix",
    "userData": true
  },
  "id": 1
}
```

Response:

```
{
  "jsonrpc": "2.0",
  "result": {
    "userid": "1",
    "username": "Admin",
    "name": "Zabbix",
    "surname": "Administrator",
    "url": "",
    "autologin": "1",
    "autologout": "0",
    "lang": "ru_RU",
    "refresh": "0",
    "theme": "default",
    "attempt_failed": "0",
    "attempt_ip": "127.0.0.1",
    "attempt_clock": "1355919038",
    "rows_per_page": "50",
    "timezone": "Europe/Riga",
    "roleid": "3",
    "userdirectoryid": "0",
    "type": 3,
    "userip": "127.0.0.1",
    "debug_mode": 0,
    "gui_access": "0",
    "mfaid": "1",
    "deprovisioned": false,
    "auth_type": 0,
    "sessionid": "5b56eee8be445e98f0bd42b435736e42",
    "secret": "cd0ba923319741c6586f3d866423a8f4"
  },
  "id": 1
}
```

See also

- [user.logout](#)

Source

CUser::login() in *ui/include/classes/api/services/CUser.php*.

user.logout

Description

string/object `user.logout`(array)

This method allows to log out of the API and invalidates the current authentication token.

Note:

This method is available to users of any type. Permissions to call the method can be revoked in user role settings. See [User roles](#) for more information.

Parameters

(array) The method accepts an empty array.

Return values

(boolean) Returns true if the user has been logged out successfully.

Examples

Logging out

Log out from the API.

Request:

```
{
  "jsonrpc": "2.0",
  "method": "user.logout",
  "params": [],
  "id": 1
}
```

Response:

```
{
  "jsonrpc": "2.0",
  "result": true,
  "id": 1
}
```

See also

- [user.login](#)

Source

CUser::login() in `ui/include/classes/api/services/CUser.php`.

user.provision

Description

object user.provision(object/array users)

This method allows to provision LDAP users.

Note:

This method is only available to *Super admin* user type. Permissions to call the method can be revoked in user role settings. See [User roles](#) for more information.

Parameters

(array) IDs of users to provision.

Return values

(object) Returns an object containing the IDs of the provisioned users under the `userids` property.

Examples

Provisioning multiple users

Provision two users.

Request:

```
{
  "jsonrpc": "2.0",
  "method": "user.provision",
  "params": [
    "1",
    "5"
  ],
  "id": 1
}
```

Response:

```
{
  "jsonrpc": "2.0",
  "result": {
    "userids": [
      "1",
      "5"
    ]
  }
}
```

```
    ],
  },
  "id": 1
}
```

Source

CUser::provision() in *ui/include/classes/api/services/CUser.php*.

user.resettotp

Description

object user.resettotp(object/array users)

This method allows to reset user TOTP secrets.

Note:

This method is only available to *Super admin* user type. Permissions to call the method can be revoked in user role settings. See [User roles](#) for more information.

Parameters

(array) IDs of users for which to reset TOTP secrets.

Note:

User sessions for the specified users will also be deleted (except for the user sending the request).

Return values

(object) Returns an object containing the IDs of the users for which TOTP secrets have been reset, under the `userids` property.

Examples

Resetting TOTP secrets for multiple users

Reset TOTP secrets for two users.

Request:

```
{
  "jsonrpc": "2.0",
  "method": "user.resettotp",
  "params": [
    "1",
    "5"
  ],
  "id": 1
}
```

Response:

```
{
  "jsonrpc": "2.0",
  "result": {
    "userids": [
      "1",
      "5"
    ]
  },
  "id": 1
}
```

See also

- [MFA object](#)

Source

CUser::resettotp() in *ui/include/classes/api/services/CUser.php*.

user.unblock

Description

object user.unblock(array userids)

This method allows to unblock users.

Note:

This method is only available to *Super admin* user type. Permissions to call the method can be revoked in user role settings. See [User roles](#) for more information.

Parameters

(array) IDs of users to unblock.

Return values

(object) Returns an object containing the IDs of the unblocked users under the `userids` property.

Examples

Unblocking multiple users

Unblock two users.

Request:

```
{
  "jsonrpc": "2.0",
  "method": "user.unblock",
  "params": [
    "1",
    "5"
  ],
  "id": 1
}
```

Response:

```
{
  "jsonrpc": "2.0",
  "result": {
    "userids": [
      "1",
      "5"
    ]
  },
  "id": 1
}
```

Source

CUser::unblock() in `ui/include/classes/api/services/CUser.php`.

user.update

Description

object user.update(object/array users)

This method allows to update existing users.

Note:

This method is available to users of any type. Permissions to call the method can be revoked in user role settings. See [User roles](#) for more information.

Note:

The strength of user password is validated according to the password policy rules defined by Authentication API. See [Authentication API](#) for more information.

Parameters

(object/array) User properties to be updated.

The `userid` property must be defined for each user, all other properties are optional. Only the passed properties will be updated, all others will remain unchanged.

Additionally to the [standard user properties](#), the method accepts the following parameters.

Parameter	Type	Description
<code>current_passwd</code>	string	User's current password. The value of this parameter can be an empty string if the user is linked to a user directory .
<code>usrgrps</code>	array	Parameter behavior: - <i>write-only</i> - <i>required</i> if <code>passwd</code> of User object is set and user changes own user password User groups to replace existing user groups.
<code>medias</code>	array	The user groups must have only the <code>usrgrp_id</code> property defined. User media to replace existing, non-provisioned media. Provisioned media can be omitted when updating media.

Return values

(object) Returns an object containing the IDs of the updated users under the `user_ids` property.

Examples**Renaming a user**

Rename a user to John Doe.

Request:

```
{
  "jsonrpc": "2.0",
  "method": "user.update",
  "params": {
    "userid": "1",
    "name": "John",
    "surname": "Doe"
  },
  "id": 1
}
```

Response:

```
{
  "jsonrpc": "2.0",
  "result": {
    "user_ids": [
      "1"
    ]
  },
  "id": 1
}
```

Changing user role

Change a role of a user.

Request:

```
{
  "jsonrpc": "2.0",
  "method": "user.update",
  "params": {
    "userid": "12",
    "roleid": "6"
  },
  "id": 1
}
```

Response:

```
{
  "jsonrpc": "2.0",
  "result": {
    "userids": [
      "12"
    ]
  },
  "id": 1
}
```

See also

- [Authentication](#)

Source

`CUser::update()` in `ui/include/classes/api/services/CUser.php`.

User directory

This class is designed to work with user directories.

Object references:

- [User directory](#)
- [Media type mappings](#)
- [Provisioning groups mappings](#)

Available methods:

- `userdirectory.create` - create new user directory
- `userdirectory.delete` - delete user directory
- `userdirectory.get` - retrieve user directory
- `userdirectory.update` - update user directory
- `userdirectory.test` - test user directory connection

User directory object

The following objects are directly related to the `userdirectory` API.

User directory

The user directory object has the following properties.

Property	Type	Description
userdirectoryid	ID	ID of the user directory. If a user directory is deleted, the value of the User object property <code>userdirectoryid</code> is set to "0" for all users that are linked to the deleted user directory. Property behavior: - <i>read-only</i> - <i>required</i> for update operations
idp_type	integer	Type of the authentication protocol used by the identity provider for the user directory. Note that only one user directory of type SAML can exist. Possible values: 1 - User directory of type LDAP; 2 - User directory of type SAML. Property behavior: - <i>required</i> for create operations
group_name	string	LDAP/SAML user directory attribute that contains the group name used to map groups between the LDAP/SAML user directory and Zabbix. Example: <i>cn</i> Property behavior: - <i>required</i> if <code>provision_status</code> is set to "Enabled" and <code>saml_jit_status</code> of Authentication object is set to "Enabled for configured SAML IdPs"
user_username	string	LDAP/SAML user directory attribute (also SCIM attribute if <code>scim_status</code> is set to "SCIM provisioning is enabled") that contains the user's name which is used as the value for the User object property <code>name</code> when the user is provisioned.
user_lastname	string	Examples: <i>cn, commonName, displayName, name</i> LDAP/SAML user directory attribute (also SCIM attribute if <code>scim_status</code> is set to "SCIM provisioning is enabled") that contains the user's last name which is used as the value for the User object property <code>surname</code> when the user is provisioned.
provision_status	integer	Examples: <i>sn, surname, lastName</i> Provisioning status of the user directory. Possible values: 0 - (<i>default</i>) Disabled (provisioning of users created by this user directory is disabled); 1 - Enabled (provisioning of users created by this user directory is enabled; additionally, the status of LDAP or SAML provisioning (<code>ldap_jit_status</code> or <code>saml_jit_status</code> of Authentication object) must be enabled).
provision_groups	array	Array of provisioning groups mappings objects for mapping LDAP/SAML user group pattern to Zabbix user group and user role. Property behavior: - <i>required</i> if <code>provision_status</code> is set to "Enabled"
provision_media	array	Array of media type mappings objects for mapping user's LDAP/SAML media attributes (e.g., email) to Zabbix user media for sending notifications.

LDAP-specific properties:

Property	Type	Description
name	string	Unique name of the user directory.
host	string	<p>Property behavior:</p> <p>- <i>required</i> if <code>idp_type</code> is set to "User directory of type LDAP" Host name, IP or URI of the LDAP server. URI must contain schema (<code>ldap://</code> or <code>ldaps://</code>), host, and port (optional).</p> <p>Examples: <i>host.example.com</i> <i>127.0.0.1</i> <i>ldap://ldap.example.com:389</i></p>
port	integer	<p>Property behavior:</p> <p>- <i>required</i> if <code>idp_type</code> is set to "User directory of type LDAP" Port of the LDAP server.</p>
base_dn	string	<p>Property behavior:</p> <p>- <i>required</i> if <code>idp_type</code> is set to "User directory of type LDAP" LDAP user directory base path to user accounts.</p> <p>Examples: <i>ou=Users,dc=example,dc=org</i> <i>ou=Users,ou=system</i> (for OpenLDAP) <i>DC=company,DC=com</i> (for Microsoft Active Directory) <i>uid=%{user},dc=example,dc=com</i> (for direct user binding; placeholder "<code>%{user}</code>" is mandatory)</p>
search_attribute	string	<p>Property behavior:</p> <p>- <i>required</i> if <code>idp_type</code> is set to "User directory of type LDAP" LDAP user directory attribute by which to identify the user account from the information provided in the login request.</p> <p>Examples: <i>uid</i> (for OpenLDAP) <i>sAMAccountName</i> (for Microsoft Active Directory)</p>
bind_dn	string	<p>Property behavior:</p> <p>- <i>required</i> if <code>idp_type</code> is set to "User directory of type LDAP" LDAP server account for binding and searching over the LDAP server.</p> <p>For direct user binding and anonymous binding, <code>bind_dn</code> must be empty.</p> <p>Examples: <i>uid=ldap_search,ou=system</i> (for OpenLDAP) <i>CN=ldap_search,OU=user_group,DC=company,DC=com</i> (for Microsoft Active Directory) <i>CN=Admin,OU=Users,OU=Zabbix,DC=zbx,DC=local</i></p>
bind_password	string	<p>Property behavior:</p> <p>- <i>supported</i> if <code>idp_type</code> is set to "User directory of type LDAP" LDAP password of the account for binding and searching over the LDAP server.</p> <p>For direct user binding and anonymous binding, <code>bind_password</code> must be empty.</p> <p>Property behavior:</p> <p>- <i>supported</i> if <code>idp_type</code> is set to "User directory of type LDAP"</p>

Property	Type	Description
description	string	Description of the user directory.
group_basedn	string	<p>Property behavior:</p> <p>- <i>supported</i> if <code>idp_type</code> is set to "User directory of type LDAP" LDAP user directory base path to groups; used to configure a user membership check in the LDAP user directory.</p> <p>Ignored when provisioning a user if <code>group_membership</code> is set.</p> <p>Example: <code>ou=Groups,dc=example,dc=com</code></p>
group_filter	string	<p>Property behavior:</p> <p>- <i>supported</i> if <code>idp_type</code> is set to "User directory of type LDAP" Filter string for retrieving LDAP user directory groups that the user is a member of; used to configure a user membership check in the LDAP user directory.</p> <p>Ignored when provisioning a user if <code>group_membership</code> is set.</p> <p>Supported <code>group_filter</code> placeholders:</p> <p><code>%{attr}</code> - search attribute (replaced by the <code>search_attribute</code> property value);</p> <p><code>%{groupattr}</code> - group attribute (replaced by the <code>group_member</code> property value);</p> <p><code>%{host}</code> - host name, IP or URI of the LDAP server (replaced by the <code>host</code> property value);</p> <p><code>%{user}</code> - Zabbix user username.</p> <p>Default: <code>(%{groupattr}=%{user})</code></p> <p>Examples:</p> <p>- <code>(member=uid=%{ref},ou=Users,dc=example,dc=com)</code> will match "User1" if an LDAP group object contains the "member" attribute with the value "uid=User1,ou=Users,dc=example,dc=com", and will return the group that "User1" is a member of;</p> <p>- <code>(%{groupattr}=cn=%{ref},ou=Users,ou=Zabbix,DC=example,DC=com)</code> will match "User1" if an LDAP group object contains the attribute specified in the <code>group_member</code> property with the value "cn=User1,ou=Users,ou=Zabbix,DC=example,DC=com", and will return the group that "User1" is a member of.</p>
group_member	string	<p>Property behavior:</p> <p>- <i>supported</i> if <code>idp_type</code> is set to "User directory of type LDAP" LDAP user directory attribute that contains information about the group members; used to configure a user membership check in the LDAP user directory.</p> <p>Ignored when provisioning a user if <code>group_membership</code> is set.</p>
group_membership	string	<p>Property behavior:</p> <p>- <i>supported</i> if <code>idp_type</code> is set to "User directory of type LDAP" LDAP user directory attribute that contains information about the groups that a user belongs to.</p> <p>Example: <code>memberOf</code></p> <p>Property behavior:</p> <p>- <i>supported</i> if <code>idp_type</code> is set to "User directory of type LDAP"</p>

Property	Type	Description
search_filter	string	<p>Custom filter string used to locate and authenticate a user in an LDAP user directory based on the information provided in the login request.</p> <p>Supported <code>search_filter</code> placeholders: <code>%{attr}</code> - search attribute name (e.g., <code>uid</code>, <code>sAMAccountName</code>); <code>%{user}</code> - Zabbix user username.</p> <p>Default: <code>(%{attr}=%{user})</code></p> <p>Property behavior: - <i>supported</i> if <code>idp_type</code> is set to "User directory of type LDAP"</p>
start_tls	integer	<p>LDAP server configuration option that allows the communication with the LDAP server to be secured using Transport Layer Security (TLS).</p> <p>Note that <code>start_tls</code> must be set to "Disabled" for hosts using the <code>ldaps://</code> protocol.</p> <p>Possible values: 0 - (default) Disabled; 1 - Enabled.</p> <p>Property behavior: - <i>supported</i> if <code>idp_type</code> is set to "User directory of type LDAP"</p>
user_ref_attr	string	<p>LDAP user directory attribute used to reference a user object. The value of <code>user_ref_attr</code> is used to get values from the specified attribute in the user directory and place them instead of the <code>%{ref}</code> placeholder in the <code>group_filter</code> string.</p> <p>Examples: <code>cn</code>, <code>uid</code>, <code>member</code>, <code>uniqueMember</code></p> <p>Property behavior: - <i>supported</i> if <code>idp_type</code> is set to "User directory of type LDAP"</p>
SAML-specific properties:		
idp_entityid	string	<p>URI that identifies the identity provider and is used to communicate with the identity provider in SAML messages.</p> <p>Example: <code>https://idp.example.com/idp</code></p> <p>Property behavior: - <i>required</i> if <code>idp_type</code> is set to "User directory of type SAML"</p>
sp_entityid	string	<p>URL or any string that identifies the identity provider's service provider.</p> <p>Examples: <code>https://idp.example.com/sp</code> <code>zabbix</code></p> <p>Property behavior: - <i>required</i> if <code>idp_type</code> is set to "User directory of type SAML"</p>
username_attribute	string	<p>SAML user directory attribute (also SCIM attribute if <code>scim_status</code> is set to "SCIM provisioning is enabled") that contains the user's username which is compared with the value of the User object property <code>username</code> when authenticating.</p> <p>Examples: <code>uid</code>, <code>userprincipalname</code>, <code>samaccountname</code>, <code>username</code>, <code>userusername</code>, <code>urn:oid:0.9.2342.19200300.100.1.1</code>, <code>urn:oid:1.3.6.1.4.1.5923.1.1.1.13</code>, <code>urn:oid:0.9.2342.19200300.100.1.44</code></p> <p>Property behavior: - <i>required</i> if <code>idp_type</code> is set to "User directory of type SAML"</p>

Property	Type	Description
sso_url	string	<p>URL of the identity provider's SAML single sign-on service, to which Zabbix will send the SAML authentication requests.</p> <p>Example: <i>http://idp.example.com/idp/sso/saml</i></p> <p>Property behavior: - <i>required</i> if <i>idp_type</i> is set to "User directory of type SAML"</p>
slo_url	string	<p>URL of the identity provider's SAML single log-out service, to which Zabbix will send the SAML logout requests.</p> <p>Example: <i>https://idp.example.com/idp/slo/saml</i></p> <p>Property behavior: - <i>supported</i> if <i>idp_type</i> is set to "User directory of type SAML"</p>
encrypt_nameid	integer	<p>Whether the SAML name ID should be encrypted.</p> <p>Possible values: 0 - (<i>default</i>) Do not encrypt name ID; 1 - Encrypt name ID.</p> <p>Property behavior: - <i>supported</i> if <i>idp_type</i> is set to "User directory of type SAML"</p>
encrypt_assertions	integer	<p>Whether the SAML assertions should be encrypted.</p> <p>Possible values: 0 - (<i>default</i>) Do not encrypt assertions; 1 - Encrypt assertions.</p> <p>Property behavior: - <i>supported</i> if <i>idp_type</i> is set to "User directory of type SAML"</p>
nameid_format	string	<p>Name ID format of the SAML identity provider's service provider.</p> <p>Examples: <i>urn:oasis:names:tc:SAML:2.0:nameid-format:persistent</i> <i>urn:oasis:names:tc:SAML:2.0:nameid-format:transient</i> <i>urn:oasis:names:tc:SAML:2.0:nameid-format:kerberos</i> <i>urn:oasis:names:tc:SAML:2.0:nameid-format:entity</i></p> <p>Property behavior: - <i>supported</i> if <i>idp_type</i> is set to "User directory of type SAML"</p>
scim_status	integer	<p>Whether SCIM provisioning for SAML is enabled or disabled.</p> <p>Possible values: 0 - (<i>default</i>) SCIM provisioning is disabled; 1 - SCIM provisioning is enabled.</p> <p>Property behavior: - <i>supported</i> if <i>idp_type</i> is set to "User directory of type SAML"</p>
sign_assertions	integer	<p>Whether the SAML assertions should be signed with a SAML signature.</p> <p>Possible values: 0 - (<i>default</i>) Do not sign assertions; 1 - Sign assertions.</p> <p>Property behavior: - <i>supported</i> if <i>idp_type</i> is set to "User directory of type SAML"</p>

Property	Type	Description
sign_authn_requests	integer	Whether the SAML AuthN requests should be signed with a SAML signature. Possible values: 0 - (<i>default</i>) Do not sign AuthN requests; 1 - Sign AuthN requests. Property behavior: - <i>supported</i> if idp_type is set to "User directory of type SAML"
sign_messages	integer	Whether the SAML messages should be signed with a SAML signature. Possible values: 0 - (<i>default</i>) Do not sign messages; 1 - Sign messages. Property behavior: - <i>supported</i> if idp_type is set to "User directory of type SAML"
sign_logout_requests	integer	Whether the SAML logout requests should be signed with a SAML signature. Possible values: 0 - (<i>default</i>) Do not sign logout requests; 1 - Sign logout requests. Property behavior: - <i>supported</i> if idp_type is set to "User directory of type SAML"
sign_logout_responses	integer	Whether the SAML logout responses should be signed with a SAML signature. Possible values: 0 - (<i>default</i>) Do not sign logout responses; 1 - Sign logout responses. Property behavior: - <i>supported</i> if idp_type is set to "User directory of type SAML"

Media type mappings

The media type mappings object has the following properties.

Property	Type	Description
userdirectory_id	Mediaid	Media type mapping ID. Property behavior: - <i>read-only</i>
name	string	Visible name in the list of media type mappings. Property behavior: - <i>required</i>
mediatypeid	ID	ID of the media type to be created; used as the value for the Media object property mediatypeid. Property behavior: - <i>required</i>

Property	Type	Description
attribute	string	LDAP/SAML user directory attribute (also SCIM attribute if <code>scim_status</code> is set to "SCIM provisioning is enabled") that contains the user's media (e.g., <code>user@example.com</code>) which is used as the value for the Media object property <code>sendto</code> . If present in data received from the LDAP/SAML identity provider, and the value is not empty, this will trigger media creation for the provisioned user. Property behavior: - <i>required</i>
active	integer	User media active property value when media is created for the provisioned user. Possible values: 0 - (<i>default</i>) enabled; 1 - disabled.
severity	integer	User media severity property value when media is created for the provisioned user. Default: 63.
period	string	User media period property value when media is created for the provisioned user. Default: 1-7,00:00-24:00.

Provisioning groups mappings

The provisioning groups mappings has the following properties.

Property	Type	Description
name	string	Full name of a group (e.g., <i>Zabbix administrators</i>) in LDAP/SAML user directory (also SCIM if <code>scim_status</code> is set to "SCIM provisioning is enabled"). Supports the wildcard character <code>"*"</code> . Unique across all provisioning groups mappings. Property behavior: - <i>required</i>
roleid	ID	ID of the user role to assign to the user. If multiple provisioning groups mappings are matched, the role of the highest user type (<i>User</i> , <i>Admin</i> , or <i>Super admin</i>) is assigned to the user. If there are multiple roles with the same user type, the first role (sorted in alphabetical order) is assigned to the user. Property behavior: - <i>required</i>
user_groups	array	Array of Zabbix user group ID objects. Each object has the following properties: <code>usrgrp_id</code> - (ID) ID of Zabbix user group to assign to the user. If multiple provisioning groups mappings are matched, Zabbix user groups of all matched mappings is assigned to the user. Property behavior: - <i>required</i>

userdirectory.create

Description

object `userdirectory.create(object/array userDirectory)`

This method allows to create new user directories.

Note:

This method is only available to *Super admin* user type.

Parameters

(object/array) User directories to create.

The method accepts user directories with the [standard user directory properties](#).

Return values

(object) Returns an object containing the IDs of the created user directories under the `userdirectoryids` property. The order of the returned IDs matches the order of the passed user directories.

Examples

Creating a user directory

Create a user directory to authenticate users with StartTLS over LDAP. Note that to authenticate users over LDAP, [LDAP authentication](#) must be enabled.

Request:

```
{
  "jsonrpc": "2.0",
  "method": "userdirectory.create",
  "params": {
    "idp_type": "1",
    "name": "LDAP API server #1",
    "host": "ldap://local.ldap",
    "port": "389",
    "base_dn": "ou=Users,dc=example,dc=org",
    "bind_dn": "cn=ldap_search,dc=example,dc=org",
    "bind_password": "ldapsecretpassword",
    "search_attribute": "uid",
    "start_tls": "1"
  },
  "id": 1
}
```

Response:

```
{
  "jsonrpc": "2.0",
  "result": {
    "userdirectoryids": [
      "3"
    ]
  },
  "id": 1
}
```

Creating a user directory (JIT provisioning enabled)

Create a user directory to authenticate users over LDAP (with JIT provisioning enabled). Note that to authenticate users over LDAP, [LDAP authentication](#) must be enabled.

Request:

```
{
  "jsonrpc": "2.0",
  "method": "userdirectory.create",
  "params": {
    "idp_type": "1",
    "name": "AD server",
    "provision_status": "1",
    "description": "",
    "host": "host.example.com",
    "port": "389",
    "base_dn": "DC=zbx,DC=local",
    "search_attribute": "sAMAccountName",
    "bind_dn": "CN=Admin,OU=Users,OU=Zabbix,DC=zbx,DC=local",
    "start_tls": "0",
  }
}
```

```

    "search_filter": "",
    "group_basedn": "OU=Zabbix,DC=zbx,DC=local",
    "group_name": "CN",
    "group_member": "member",
    "group_filter": "(%{groupattr}=CN=%{ref},OU=Users,OU=Zabbix,DC=zbx,DC=local)",
    "group_membership": "",
    "user_username": "givenName",
    "user_lastname": "sn",
    "user_ref_attr": "CN",
    "provision_media": [
        {
            "name": "example.com",
            "mediatypeid": "1",
            "attribute": "user@example.com"
        }
    ],
    "provision_groups": [
        {
            "name": "*",
            "roleid": "4",
            "user_groups": [
                {
                    "usrgrpid": "8"
                }
            ]
        },
        {
            "name": "Zabbix administrators",
            "roleid": "2",
            "user_groups": [
                {
                    "usrgrpid": "7"
                },
                {
                    "usrgrpid": "8"
                }
            ]
        }
    ]
},
    "id": 1
}

```

Response:

```

{
    "jsonrpc": "2.0",
    "result": {
        "userdirectoryids": [
            "2"
        ]
    },
    "id": 1
}

```

Source

CUserDirectory::create() in *ui/include/classes/api/services/CUserDirectory.php*.

userdirectory.delete

Description

object userdirectory.delete(array userDirectoryIds)

This method allows to delete user directories. User directory cannot be deleted when it is directly used for at least one user group. Default LDAP user directory cannot be deleted when `authentication.ldap_configured` is set to 1 or when there are more user directories left.

Note:

This method is only available to *Super admin* user type.

Parameters

(array) IDs of the user directories to delete.

Return values

(object) Returns an object containing the IDs of the deleted user directories under the `userdirectoryids` property.

Examples

Deleting multiple user directories

Delete two user directories.

Request:

```
{
  "jsonrpc": "2.0",
  "method": "userdirectory.delete",
  "params": [
    "2",
    "12"
  ],
  "id": 1
}
```

Response:

```
{
  "jsonrpc": "2.0",
  "result": {
    "userdirectoryids": [
      "2",
      "12"
    ]
  },
  "id": 1
}
```

Source

`CUserDirectory::delete()` in `ui/include/classes/api/services/CUserDirectory.php`.

userdirectory.get

Description

`integer/array userdirectory.get(object parameters)`

The method allows to retrieve user directories according to the given parameters.

Note:

This method is only available to *Super admin* user types.

Parameters

(object) Parameters defining the desired output.

The method supports the following parameters.

Parameter	Type	Description
<code>userdirectoryids</code>	ID/array	Return only user directories with the given IDs.

Parameter	Type	Description
selectUsrgrps	query	Return a <code>usrgrps</code> property with user groups associated with a user directory.
selectProvisionMedia	query	Supports <code>count</code> . Return a <code>provision_media</code> property with media type mappings associated with a user directory.
selectProvisionGroups	query	Return a <code>provision_groups</code> property with provisioning groups mappings associated with a user directory.
sortfield	string/array	Sort the result by the given properties.
filter	object	Possible values: <code>name</code> . Return only those results that exactly match the given filter. Accepts an object, where the keys are property names, and the values are either a single value or an array of values. Supports properties: <code>userdirectoryid</code> , <code>idp_type</code> , <code>provision_status</code> .
search	object	Return results that match the given pattern (case-insensitive). Accepts an object, where the keys are property names, and the values are strings to search for. If no additional options are given, this will perform a LIKE <code>"%...%"</code> search. Supported properties: <code>name</code> , <code>description</code> . User directory of type SAML will have an empty value for both <code>name</code> and <code>description</code> properties. Both properties can be changed with the <code>userdirectory.update</code> operation.
countOutput	boolean	These parameters being common for all get methods are described in detail in the reference commentary .
excludeSearch	boolean	
limit	integer	
output	query	
preservekeys	boolean	
searchByAny	boolean	
searchWildcardsEnabled	boolean	
sortorder	string/array	
startSearch	boolean	

Return values

(integer/array) Returns either:

- an array of objects;
- the count of retrieved objects, if the `countOutput` parameter has been used.

Examples

Retrieving user directories

Retrieve all user directories with additional properties that display media type mappings and provisioning groups mappings associated with each user directory.

Request:

```
{
  "jsonrpc": "2.0",
  "method": "userdirectory.get",
  "params": {
    "output": "extend",
    "selectProvisionMedia": "extend",
    "selectProvisionGroups": "extend"
  },
}
```

```
"id": 1
}
```

Response:

```
{
  "jsonrpc": "2.0",
  "result": [
    {
      "userdirectoryid": "1",
      "idp_type": "2",
      "name": "",
      "provision_status": "1",
      "description": "",
      "group_name": "groups",
      "user_username": "",
      "user_lastname": "",
      "idp_entityid": "http://example.com/simplesaml/saml2/idp/metadata.php",
      "sso_url": "http://example.com/simplesaml/saml2/idp/SSOService.php",
      "slo_url": "",
      "username_attribute": "uid",
      "sp_entityid": "zabbix",
      "nameid_format": "",
      "sign_messages": "0",
      "sign_assertions": "0",
      "sign_authn_requests": "0",
      "sign_logout_requests": "0",
      "sign_logout_responses": "0",
      "encrypt_nameid": "0",
      "encrypt_assertions": "0",
      "scim_status": "1",
      "provision_media": [
        {
          "userdirectory_mediaid": "1",
          "name": "example.com",
          "mediatypeid": "1",
          "attribute": "user@example.com",
          "active": "0",
          "severity": "63",
          "period": "1-7,00:00-24:00"
        }
      ],
      "provision_groups": [
        {
          "name": "*",
          "roleid": "1",
          "user_groups": [
            {
              "usrgrp": "13"
            }
          ]
        }
      ]
    },
    {
      "userdirectoryid": "2",
      "idp_type": "1",
      "name": "AD server",
      "provision_status": "1",
      "description": "",
      "host": "host.example.com",
      "port": "389",
      "base_dn": "DC=zbx,DC=local",
    }
  ]
}
```

```

"search_attribute": "sAMAccountName",
"bind_dn": "CN=Admin,OU=Users,OU=Zabbix,DC=zbx,DC=local",
"start_tls": "0",
"search_filter": "",
"group_basedn": "OU=Zabbix,DC=zbx,DC=local",
"group_name": "CN",
"group_member": "member",
"group_filter": "(%{groupattr}=CN=%{ref},OU=Users,OU=Zabbix,DC=zbx,DC=local)",
"group_membership": "",
"user_username": "givenName",
"user_lastname": "sn",
"user_ref_attr": "CN",
"provision_media": [
  {
    "userdirectory_mediaid": "2",
    "name": "example.com",
    "mediatypeid": "1",
    "attribute": "user@example.com",
    "active": "0",
    "severity": "63",
    "period": "1-7,00:00-24:00"
  }
],
"provision_groups": [
  {
    "name": "*",
    "roleid": "4",
    "user_groups": [
      {
        "usrgrpid": "8"
      }
    ]
  },
  {
    "name": "Zabbix administrators",
    "roleid": "2",
    "user_groups": [
      {
        "usrgrpid": "7"
      },
      {
        "usrgrpid": "8"
      }
    ]
  }
]
},
{
  "userdirectoryid": "3",
  "idp_type": "1",
  "name": "LDAP API server #1",
  "provision_status": "0",
  "description": "",
  "host": "ldap://local.ldap",
  "port": "389",
  "base_dn": "ou=Users,dc=example,dc=org",
  "search_attribute": "uid",
  "bind_dn": "cn=ldap_search,dc=example,dc=org",
  "start_tls": "1",
  "search_filter": "",
  "group_basedn": "",
  "group_name": "",

```



```

        "group_member": "",
        "group_filter": "",
        "group_membership": "",
        "user_username": "",
        "user_lastname": "",
        "user_ref_attr": "",
        "provision_media": [],
        "provision_groups": []
    }
],
    "id": 1
}

```

See also

- [User group](#)

Source

CUserDirectory::get() in *ui/include/classes/api/services/CUserDirectory.php*.

userdirectory.test

Description

object userdirectory.test(array userDirectory)

This method allows to test user directory connection settings.

Note:

This method also allows to test what configured data matches the user directory settings for user provisioning (e.g., what user role, user groups, user medias will be assigned to the user). For this type of test the API request should be made for a **user directory** that has `provision_status` set to enabled.

Note:

This method is only available to *Super admin* user type.

Parameters

(object) User directory properties.

Since `userdirectory.get` API does not return `bind_password` field, `userdirectoryid` and/or `bind_password` should be supplied.

Additionally to the [standard user directory properties](#), the method accepts the following parameters.

Parameter	Type	Description
<code>test_username</code>	string	Username to test in user directory.
<code>test_password</code>	string	Username associated password to test in user directory.

Return values

(bool) Returns true on success.

Examples

Test user directory for existing user

Test user directory "3" for "user1".

Request:

```

{
    "jsonrpc": "2.0",
    "method": "userdirectory.test",
    "params": {
        "userdirectoryid": "3",

```

```

    "host": "127.0.0.1",
    "port": "389",
    "base_dn": "ou=Users,dc=example,dc=org",
    "search_attribute": "uid",
    "bind_dn": "cn=ldap_search,dc=example,dc=org",
    "bind_password": "password",
    "test_username": "user1",
    "test_password": "password"
  },
  "id": 1
}

```

Response:

```

{
  "jsonrpc": "2.0",
  "result": true,
  "id": 1
}

```

Test user directory for non-existing user

Test user directory "3" for non-existing "user2".

Request:

```

{
  "jsonrpc": "2.0",
  "method": "userdirectory.test",
  "params": {
    "userdirectoryid": "3",
    "host": "127.0.0.1",
    "port": "389",
    "base_dn": "ou=Users,dc=example,dc=org",
    "search_attribute": "uid",
    "bind_dn": "cn=ldap_search,dc=example,dc=org",
    "test_username": "user2",
    "test_password": "password"
  },
  "id": 1
}

```

Response:

```

{
  "jsonrpc": "2.0",
  "error": {
    "code": -32500,
    "message": "Application error.",
    "data": "Incorrect user name or password or account is temporarily blocked."
  },
  "id": 1
}

```

Test user directory for user provisioning

Test userdirectory "3" for what configured data matches the user directory settings for "user3" provisioning (e.g., what user role, user groups, user medias will be assigned to the user).

Request:

```

{
  "jsonrpc": "2.0",
  "method": "userdirectory.test",
  "params": {
    "userdirectoryid": "2",
    "host": "host.example.com",
    "port": "389",

```

```

    "base_dn": "DC=zbx,DC=local",
    "search_attribute": "sAMAccountName",
    "bind_dn": "CN=Admin,OU=Users,OU=Zabbix,DC=zbx,DC=local",
    "test_username": "user3",
    "test_password": "password"
  },
  "id": 1
}

```

Response:

```

{
  "jsonrpc": "2.0",
  "result": {
    "username": "user3",
    "name": "John",
    "surname": "Doe",
    "medias": [],
    "usrgrps": [
      {
        "usrgrpid": "8"
      },
      {
        "usrgrpid": "7"
      }
    ],
    "roleid": "2",
    "userdirectoryid": "2"
  },
  "id": 1
}

```

Source

CUserDirectory::test() in `ui/include/classes/api/services/CUserDirectory.php`.

userdirectory.update

Description

object userdirectory.update(object/array userDirectory)

This method allows to update existing user directories.

Note:

This method is only available to *Super admin* user type.

Parameters

(object/array) **User directory properties** to be updated.

The userdirectoryid property must be defined for each user directory, all other properties are optional. Only the passed properties will be updated, all others will remain unchanged.

Return values

(object) Returns an object containing the IDs of the updated user directories under the userdirectoryids property.

Examples

Update bind password for user directory

Set new bind password for a user directory.

Request:

```

{
  "jsonrpc": "2.0",
  "method": "userdirectory.update",

```

```
"params": {
  "userdirectoryid": "3",
  "bind_password": "newldappassword"
},
"id": 1
}
```

Response:

```
{
  "jsonrpc": "2.0",
  "result": {
    "userdirectoryids": [
      "3"
    ]
  },
  "id": 1
}
```

Update mappings for user directory

Update provisioning groups mappings and media type mappings for user directory "2".

Request:

```
{
  "jsonrpc": "2.0",
  "method": "userdirectory.update",
  "params": {
    "userdirectoryid": "2",
    "provision_media": [
      {
        "userdirectory_mediaid": "2"
      }
    ],
    "provision_groups": [
      {
        "name": "Zabbix administrators",
        "roleid": "2",
        "user_groups": [
          {
            "usrgrp": "7"
          },
          {
            "usrgrp": "8"
          },
          {
            "usrgrp": "11"
          }
        ]
      }
    ]
  },
  "id": 1
}
```

Response:

```
{
  "jsonrpc": "2.0",
  "result": {
    "userdirectoryids": [
      "2"
    ]
  },
  "id": 1
}
```

```
}
```

Source

CUserDirectory::update() in *ui/include/classes/api/services/CUserDirectory.php*.

User group

This class is designed to work with user groups.

Object references:

- [User group](#)
- [Permission](#)
- [Tag-based permission](#)

Available methods:

- [usergroup.create](#) - create new user groups
- [usergroup.delete](#) - delete user groups
- [usergroup.get](#) - retrieve user groups
- [usergroup.update](#) - update user groups

User group object

The following objects are directly related to the usergroup API.

User group

The user group object has the following properties.

Property	Type	Description
usrgrpId	ID	ID of the user group. Property behavior: - <i>read-only</i>
name	string	- <i>required</i> for update operations Name of the user group. Property behavior: - <i>required</i> for create operations
debug_mode	integer	Whether debug mode is enabled or disabled. Possible values: 0 - (<i>default</i>) disabled; 1 - enabled.
gui_access	integer	Frontend authentication method of the users in the group. Possible values: 0 - (<i>default</i>) use the system default authentication method; 1 - use internal authentication; 2 - use LDAP authentication; 3 - disable access to the frontend.
mfa_status	integer	Whether MFA is enabled or disabled for the users in the group. Possible values: 0 - disabled (for all configured MFA methods); 1 - enabled (for all configured MFA methods).
mfaId	ID	MFA method used for the users in the group. Property behavior: - <i>supported</i> if mfa_status of Authentication object is set to "Enabled"

Property	Type	Description
users_status	integer	Whether the user group is enabled or disabled. For deprovisioned users, the user group cannot be enabled. Possible values: 0 - (<i>default</i>) enabled; 1 - disabled.
userdirectoryid	ID	ID of the user directory used for authentication. Property behavior: - <i>supported</i> if <code>gui_access</code> is set to "use the system default authentication method" or "use LDAP authentication"

Permission

The permission object has the following properties.

Property	Type	Description
id	ID	ID of the host group or template group to add permission to. Property behavior: - <i>required</i>
permission	integer	Access level to the host group or template group. Possible values: 0 - access denied; 2 - read-only access; 3 - read-write access. Property behavior: - <i>required</i> for create operations

Tag-based permission

The tag-based permission object has the following properties.

Property	Type	Description
groupid	ID	ID of the host group to add permission to. Property behavior: - <i>required</i>
tag	string	Tag name.
value	string	Tag value.

usergroup.create

Description

`object usergroup.create(object/array userGroups)`

This method allows to create new user groups.

Note:

This method is only available to *Super admin* user type. Permissions to call the method can be revoked in user role settings. See [User roles](#) for more information.

Parameters

(object/array) User groups to create.

Additionally to the **standard user group properties**, the method accepts the following parameters.

Parameter	Type	Description
hostgroup_rights	object/array	Host group permissions to assign to the user group.
templategroup_rights	object/array	Template group permissions to assign to the user group.
tag_filters	array	Tag-based permissions to assign to the user group.
users	object/array	Users to add to the user group.
The user must have only the <code>userid</code> property defined.		

Return values

(object) Returns an object containing the IDs of the created user groups under the `usrgrpids` property. The order of the returned IDs matches the order of the passed user groups.

Examples

Creating a user group

Create a user group *Operation managers* with denied access to host group "2", and add a user to it.

Request:

```
{
  "jsonrpc": "2.0",
  "method": "usergroup.create",
  "params": {
    "name": "Operation managers",
    "hostgroup_rights": {
      "id": "2",
      "permission": 0
    },
    "users": [
      {
        "userid": "12"
      }
    ]
  },
  "id": 1
}
```

Response:

```
{
  "jsonrpc": "2.0",
  "result": {
    "usrgrpids": [
      "20"
    ]
  },
  "id": 1
}
```

See also

- [Permission](#)

Source

`CUserGroup::create()` in `ui/include/classes/api/services/CUserGroup.php`.

usergroup.delete

Description

object `usergroup.delete(array userGroupIds)`

This method allows to delete user groups.

Attention:

Deprovisioned users group (the user group specified for `disabled_usrgrp_id` in **Authentication**) cannot be deleted.

Note:

This method is only available to *Super admin* user type. Permissions to call the method can be revoked in user role settings. See **User roles** for more information.

Parameters

(array) IDs of the user groups to delete.

Return values

(object) Returns an object containing the IDs of the deleted user groups under the `usrgrpids` property.

Examples

Deleting multiple user groups

Delete two user groups.

Request:

```
{
  "jsonrpc": "2.0",
  "method": "usergroup.delete",
  "params": [
    "20",
    "21"
  ],
  "id": 1
}
```

Response:

```
{
  "jsonrpc": "2.0",
  "result": {
    "usrgrpids": [
      "20",
      "21"
    ]
  },
  "id": 1
}
```

Source

`CUserGroup::delete()` in `ui/include/classes/api/services/CUserGroup.php`.

usergroup.get

Description

integer/array `usergroup.get(object parameters)`

The method allows to retrieve user groups according to the given parameters.

Note:

This method is available to users of any type. Permissions to call the method can be revoked in user role settings. See **User roles** for more information.

Parameters

(object) Parameters defining the desired output.

The method supports the following parameters.

Parameter	Type	Description
mfaids	ID/array	Return only user groups with the given MFA methods.
mfa_status	integer	Return only user groups with the given MFA status.
status	integer	Refer to the user group page for a list of supported statuses. Return only user groups with the given status.
userids	ID/array	Refer to the user group page for a list of supported statuses. Return only user groups that contain the given users.
usrgrpids	ID/array	Return only user groups with the given IDs.
selectTagFilters	query	Return user group tag-based permissions in the <code>tag_filters</code> property.
selectUsers	query	Return the users from the user group in the <code>users</code> property.
selectHostGroupRights	query	Return user group host group <code>permissions</code> in the <code>hostgroup_rights</code> property.
selectTemplateGroupRights	query	Refer to the user group page for a list of access levels to host groups. Return user group template group <code>permissions</code> in the <code>templategroup_rights</code> property.
limitSelects	integer	Refer to the user group page for a list of access levels to template groups. Limits the number of records returned by subselects.
sortfield	string/array	Sort the result by the given properties.
countOutput	boolean	Possible values: <code>usrgrp_id</code> , <code>name</code> . These parameters being common for all get methods are described in detail in the reference commentary .
editable	boolean	
excludeSearch	boolean	
filter	object	
limit	integer	
output	query	
preservekeys	boolean	
search	object	
searchByAny	boolean	
searchWildcardsEnabled	boolean	
sortorder	string/array	
startSearch	boolean	

Return values

(integer/array) Returns either:

- an array of objects;
- the count of retrieved objects, if the `countOutput` parameter has been used.

Examples

Retrieving enabled user groups

Retrieve all enabled user groups.

Request:

```
{
  "jsonrpc": "2.0",
  "method": "usergroup.get",
  "params": {
    "output": "extend",
    "status": 0
  },
  "id": 1
}
```

Response:

```

{
  "jsonrpc": "2.0",
  "result": [
    {
      "usrgrpid": "7",
      "name": "Zabbix administrators",
      "gui_access": "0",
      "users_status": "0",
      "debug_mode": "1",
      "userdirectoryid": "0",
      "mfa_status": "0",
      "mfaid": "0"
    },
    {
      "usrgrpid": "8",
      "name": "Guests",
      "gui_access": "0",
      "users_status": "0",
      "debug_mode": "0",
      "userdirectoryid": "0",
      "mfa_status": "0",
      "mfaid": "0"
    },
    {
      "usrgrpid": "11",
      "name": "Enabled debug mode",
      "gui_access": "0",
      "users_status": "0",
      "debug_mode": "1",
      "userdirectoryid": "0",
      "mfa_status": "0",
      "mfaid": "0"
    },
    {
      "usrgrpid": "12",
      "name": "No access to the frontend",
      "gui_access": "2",
      "users_status": "0",
      "debug_mode": "0",
      "userdirectoryid": "0",
      "mfa_status": "0",
      "mfaid": "0"
    },
    {
      "usrgrpid": "14",
      "name": "Read only",
      "gui_access": "0",
      "users_status": "0",
      "debug_mode": "0",
      "userdirectoryid": "0",
      "mfa_status": "0",
      "mfaid": "0"
    },
    {
      "usrgrpid": "18",
      "name": "Deny",
      "gui_access": "0",
      "users_status": "0",
      "debug_mode": "0",
      "userdirectoryid": "0",
      "mfa_status": "0",
      "mfaid": "0"
    }
  ]
}

```

```

    }
  ],
  "id": 1
}

```

See also

- [User](#)

Source

CUserGroup::get() in *ui/include/classes/api/services/CUserGroup.php*.

usergroup.update

Description

object usergroup.update(object/array userGroups)

This method allows to update existing user groups.

Note:

This method is only available to *Super admin* user type. Permissions to call the method can be revoked in user role settings. See [User roles](#) for more information.

Parameters

(object/array) User group properties to be updated.

The `usrgrp_id` property must be defined for each user group, all other properties are optional. Only the passed properties will be updated, all others will remain unchanged.

Additionally to the [standard user group properties](#), the method accepts the following parameters.

Parameter	Type	Description
<code>hostgroup_rights</code>	object/array	Host group permissions to replace the current permissions assigned to the user group.
<code>templategroup_rights</code>	object/array	Template group permissions to replace the current permissions assigned to the user group.
<code>tag_filters</code>	array	Tag-based permissions to replace the current permissions assigned to the user group.
<code>users</code>	object/array	Users to replace the current users assigned to the user group.

The user must have only the `userid` property defined.

Return values

(object) Returns an object containing the IDs of the updated user groups under the `usrgrp_ids` property.

Examples

Enabling a user group and updating permissions

Enable a user group and provide read-write access for it to host groups "2" and "4".

Request:

```

{
  "jsonrpc": "2.0",
  "method": "usergroup.update",
  "params": {
    "usrgrp_id": "17",
    "users_status": "0",
    "hostgroup_rights": [
      {
        "id": "2",
        "permission": 3
      }
    ]
  }
}

```

```

    {
      "id": "4",
      "permission": 3
    }
  ],
  "id": 1
}

```

Response:

```

{
  "jsonrpc": "2.0",
  "result": {
    "usrgrpids": [
      "17"
    ]
  },
  "id": 1
}

```

See also

- [Permission](#)

Source

CUserGroup::update() in *ui/include/classes/api/services/CUserGroup.php*.

User macro

This class is designed to work with host-level and global user macros.

Object references:

- [Global macro](#)
- [Host macro](#)

Available methods:

- [usermacro.create](#) - create new host macros
- [usermacro.createglobal](#) - create new global macros
- [usermacro.delete](#) - delete host macros
- [usermacro.deleteglobal](#) - delete global macros
- [usermacro.get](#) - retrieve host and global macros
- [usermacro.update](#) - update host macros
- [usermacro.updateglobal](#) - update global macros

User macro object

The following objects are directly related to the usermacro API.

Global macro

The global macro object has the following properties.

Property	Type	Description
globalmacroid	ID	ID of the global macro.
macro	string	Macro string.

Property behavior:

- *read-only*
- *required* for update operations

Property behavior:

- *required* for create operations

Property	Type	Description
value	string	Value of the macro.
type	integer	<p>Property behavior:</p> <ul style="list-style-type: none"> - <i>write-only</i> if type is set to "Secret macro" - <i>required</i> for create operations Type of macro.
description	string	<p>Possible values:</p> <ul style="list-style-type: none"> 0 - (<i>default</i>) Text macro; 1 - Secret macro; 2 - Vault secret. Description of the macro.

Host macro

The host macro object defines a macro available on a host, host prototype or template. It has the following properties.

Property	Type	Description
hostmacroid	ID	ID of the host macro.
hostid	ID	<p>Property behavior:</p> <ul style="list-style-type: none"> - <i>read-only</i> - <i>required</i> for update operations ID of the host that the macro belongs to.
macro	string	<p>Property behavior:</p> <ul style="list-style-type: none"> - <i>constant</i> - <i>required</i> for create operations Macro string.
value	string	<p>Property behavior:</p> <ul style="list-style-type: none"> - <i>required</i> for create operations Value of the macro.
type	integer	<p>Property behavior:</p> <ul style="list-style-type: none"> - <i>write-only</i> if type is set to "Secret macro" - <i>required</i> for create operations Type of macro.
description	string	<p>Possible values:</p> <ul style="list-style-type: none"> 0 - (<i>default</i>) Text macro; 1 - Secret macro; 2 - Vault secret. Description of the macro.
automatic	integer	<p>Defines whether the macro is controlled by discovery rule.</p> <p>Possible values:</p> <ul style="list-style-type: none"> 0 - (<i>default</i>) Macro is managed by user; 1 - Macro is managed by discovery rule. <p>User is not allowed to create automatic macro. To update automatic macro, it must be converted to manual.</p>

usermacro.create

Description

`object usermacro.create(object/array hostMacros)`

This method allows to create new host macros.

Note:

This method is only available to *Admin* and *Super admin* user types. Permissions to call the method can be revoked in user role settings. See [User roles](#) for more information.

Parameters

(object/array) Host macros to create.

The method accepts host macros with the [standard host macro properties](#).

Return values

(object) Returns an object containing the IDs of the created host macros under the `hostmacroids` property. The order of the returned IDs matches the order of the passed host macros.

Examples**Creating a host macro**

Create a host macro "{`$SNMP_COMMUNITY`}" with the value "public" on host "10198".

Request:

```
{
  "jsonrpc": "2.0",
  "method": "usermacro.create",
  "params": {
    "hostid": "10198",
    "macro": "{$SNMP_COMMUNITY}",
    "value": "public"
  },
  "id": 1
}
```

Response:

```
{
  "jsonrpc": "2.0",
  "result": {
    "hostmacroids": [
      "11"
    ]
  },
  "id": 1
}
```

Source

`UserMacro::create()` in `ui/include/classes/api/services/CUserMacro.php`.

usermacro.createglobal**Description**

object `usermacro.createglobal(object/array globalMacros)`

This method allows to create new global macros.

Note:

This method is only available to *Super admin* user type. Permissions to call the method can be revoked in user role settings. See [User roles](#) for more information.

Parameters

(object/array) Global macros to create.

The method accepts global macros with the [standard global macro properties](#).

Return values

(object) Returns an object containing the IDs of the created global macros under the `globalmacroids` property. The order of the returned IDs matches the order of the passed global macros.

Examples

Creating a global macro

Create a global macro `"{$SNMP_COMMUNITY}"` with value `"public"`.

Request:

```
{
  "jsonrpc": "2.0",
  "method": "usermacro.createglobal",
  "params": {
    "macro": "{$SNMP_COMMUNITY}",
    "value": "public"
  },
  "id": 1
}
```

Response:

```
{
  "jsonrpc": "2.0",
  "result": {
    "globalmacroids": [
      "6"
    ]
  },
  "id": 1
}
```

Source

`CUserMacro::createGlobal()` in `ui/include/classes/api/services/CUserMacro.php`.

usermacro.delete

Description

object `usermacro.delete(array hostMacroIds)`

This method allows to delete host macros.

Note:

This method is only available to *Admin* and *Super admin* user types. Permissions to call the method can be revoked in user role settings. See [User roles](#) for more information.

Parameters

(array) IDs of the host macros to delete.

Return values

(object) Returns an object containing the IDs of the deleted host macros under the `hostmacroids` property.

Examples

Deleting multiple host macros

Delete two host macros.

Request:

```
{
  "jsonrpc": "2.0",
  "method": "usermacro.delete",
  "params": [
    "32",
    "11"
  ]
}
```

```
    ],  
    "id": 1  
}
```

Response:

```
{  
  "jsonrpc": "2.0",  
  "result": {  
    "hostmacroids": [  
      "32",  
      "11"  
    ]  
  },  
  "id": 1  
}
```

Source

CUserMacro::delete() in *ui/include/classes/api/services/CUserMacro.php*.

usermacro.deleteglobal

Description

object usermacro.deleteglobal(array globalMacroIds)

This method allows to delete global macros.

Note:

This method is only available to *Super admin* user type. Permissions to call the method can be revoked in user role settings. See [User roles](#) for more information.

Parameters

(array) IDs of the global macros to delete.

Return values

(object) Returns an object containing the IDs of the deleted global macros under the `globalmacroids` property.

Examples

Deleting multiple global macros

Delete two global macros.

Request:

```
{  
  "jsonrpc": "2.0",  
  "method": "usermacro.deleteglobal",  
  "params": [  
    "32",  
    "11"  
  ],  
  "id": 1  
}
```

Response:

```
{  
  "jsonrpc": "2.0",  
  "result": {  
    "globalmacroids": [  
      "32",  
      "11"  
    ]  
  },  
}
```



```
"id": 1
}
```

Source

CUserMacro::deleteGlobal() in *ui/include/classes/api/services/CUserMacro.php*.

usermacro.get

Description

integer/array usermacro.get(object parameters)

The method allows to retrieve host and global macros according to the given parameters.

Note:

This method is available to users of any type. Permissions to call the method can be revoked in user role settings. See [User roles](#) for more information.

Parameters

(object) Parameters defining the desired output.

The method supports the following parameters.

Parameter	Type	Description
globalmacro	flag	Return global macros instead of host macros.
globalmacroids	ID/array	Return only global macros with the given IDs.
groupids	ID/array	Return only host macros that belong to hosts or templates from the given host groups or template groups.
hostids	ID/array	Return only macros that belong to the given hosts or templates.
hostmacroids	ID/array	Return only host macros with the given IDs.
inherited	boolean	If set to <code>true</code> return only host prototype user macros inherited from a template.
selectHostGroups	query	Return host groups that the host macro belongs to in the <code>hostgroups</code> property.
		Used only when retrieving host macros.
selectHosts	query	Return hosts that the host macro belongs to in the <code>hosts</code> property.
		Used only when retrieving host macros.
selectTemplateGroups	query	Return template groups that the template macro belongs to in the <code>templategroups</code> property.
		Used only when retrieving template macros.
selectTemplates	query	Return templates that the host macro belongs to in the <code>templates</code> property.
		Used only when retrieving host macros.
sortfield	string/array	Sort the result by the given properties.
		Possible values: <code>macro</code> .
countOutput	boolean	These parameters being common for all <code>get</code> methods are described in detail in the reference commentary page.
editable	boolean	
excludeSearch	boolean	
filter	object	
limit	integer	
output	query	
preservekeys	boolean	
search	object	
searchByAny	boolean	
searchWildcardsEnabled	boolean	
sortorder	string/array	

Parameter	Type	Description
startSearch	boolean	

Return values

(integer/array) Returns either:

- an array of objects;
- the count of retrieved objects, if the countOutput parameter has been used.

Examples

Retrieving host macros for a host

Retrieve all host macros defined for host "10198".

Request:

```
{
  "jsonrpc": "2.0",
  "method": "usermacro.get",
  "params": {
    "output": "extend",
    "hostids": "10198"
  },
  "id": 1
}
```

Response:

```
{
  "jsonrpc": "2.0",
  "result": [
    {
      "hostmacroid": "9",
      "hostid": "10198",
      "macro": "{$INTERFACE}",
      "value": "eth0",
      "description": "",
      "type": "0",
      "automatic": "0"
    },
    {
      "hostmacroid": "11",
      "hostid": "10198",
      "macro": "{$SNMP_COMMUNITY}",
      "value": "public",
      "description": "",
      "type": "0",
      "automatic": "0"
    }
  ],
  "id": 1
}
```

Retrieving global macros

Retrieve all global macros.

Request:

```
{
  "jsonrpc": "2.0",
  "method": "usermacro.get",
  "params": {
    "output": "extend",
    "globalmacro": true
  },
  "id": 1
}
```

```
"id": 1
}
```

Response:

```
{
  "jsonrpc": "2.0",
  "result": [
    {
      "globalmacroid": "6",
      "macro": "{$SNMP_COMMUNITY}",
      "value": "public",
      "description": "",
      "type": "0"
    }
  ],
  "id": 1
}
```

Source

CUserMacro::get() in `ui/include/classes/api/services/CUserMacro.php`.

usermacro.update

Description

object usermacro.update(object/array hostMacros)

This method allows to update existing host macros.

Note:

This method is only available to *Admin* and *Super admin* user types. Permissions to call the method can be revoked in user role settings. See [User roles](#) for more information.

Parameters

(object/array) **Host macro properties** to be updated.

The `hostmacroid` property must be defined for each host macro, all other properties are optional. Only the passed properties will be updated, all others will remain unchanged.

Return values

(object) Returns an object containing the IDs of the updated host macros under the `hostmacroids` property.

Examples

Changing the value of a host macro

Change the value of a host macro to "public".

Request:

```
{
  "jsonrpc": "2.0",
  "method": "usermacro.update",
  "params": {
    "hostmacroid": "1",
    "value": "public"
  },
  "id": 1
}
```

Response:

```
{
  "jsonrpc": "2.0",
  "result": {
    "hostmacroids": [
```

```

        "1"
    ]
},
"id": 1
}

```

Change macro value that was created by discovery rule

Convert discovery rule created "automatic" macro to "manual" and change its value to "new-value".

Request:

```

{
  "jsonrpc": "2.0",
  "method": "usermacro.update",
  "params": {
    "hostmacroid": "1",
    "value": "new-value",
    "automatic": "0"
  },
  "id": 1
}

```

Response:

```

{
  "jsonrpc": "2.0",
  "result": {
    "hostmacroids": [
      "1"
    ]
  },
  "id": 1
}

```

Source

CUserMacro::update() in *ui/include/classes/api/services/CUserMacro.php*.

usermacro.updateglobal

Description

object usermacro.updateglobal(object/array globalMacros)

This method allows to update existing global macros.

Note:

This method is only available to *Super admin* user type. Permissions to call the method can be revoked in user role settings. See [User roles](#) for more information.

Parameters

(object/array) **Global macro properties** to be updated.

The `globalmacroid` property must be defined for each global macro, all other properties are optional. Only the passed properties will be updated, all others will remain unchanged.

Return values

(object) Returns an object containing the IDs of the updated global macros under the `globalmacroids` property.

Examples

Changing the value of a global macro

Change the value of a global macro to "public".

Request:

```
{
  "jsonrpc": "2.0",
  "method": "usermacro.updateglobal",
  "params": {
    "globalmacroid": "1",
    "value": "public"
  },
  "id": 1
}
```

Response:

```
{
  "jsonrpc": "2.0",
  "result": {
    "globalmacroids": [
      "1"
    ]
  },
  "id": 1
}
```

Source

CUserMacro::updateGlobal() in *ui/include/classes/api/services/CUserMacro.php*.

Value map

This class is designed to work with value maps.

Object references:

- [Value map](#)
- [Value mappings](#)

Available methods:

- [valuemap.create](#) - create new value maps
- [valuemap.delete](#) - delete value maps
- [valuemap.get](#) - retrieve value maps
- [valuemap.update](#) - update value maps

Value map object

The following objects are directly related to the `valuemap` API.

Value map

The value map object has the following properties.

Property	Type	Description
valuemapid	ID	ID of the value map. Property behavior: - <i>read-only</i>
hostid	ID	ID of the host or template that the value map belongs to. Property behavior: - <i>constant</i>
name	string	Name of the value map. Property behavior: - <i>required</i> for create operations

Property	Type	Description
mappings	array	Value mappings for current value map. The mapping object is described in detail below .
uuid	string	<p>Universal unique identifier, used for linking imported value maps to already existing ones. Auto-generated, if not given.</p> <p>Property behavior: - <i>required</i> for create operations</p> <p>Property behavior: - <i>supported</i> if the value map belongs to a template</p>

Value mappings

The value mappings object defines value mappings of the value map. It has the following properties.

Property	Type	Description
type	integer	<p>Mapping match type.</p> <p>Possible values: 0 - (<i>default</i>) mapping will be applied if value is equal; 1 - mapping will be applied if value is greater or equal¹; 2 - mapping will be applied if value is less or equal¹; 3 - mapping will be applied if value is in range (ranges are inclusive; multiple ranges, separated by comma character, can be defined)¹; 4 - mapping will be applied if value matches a regular expression²; 5 - if no matches are found, mapping will not be applied, and the default value will be used.</p> <p>If type is set to "0", "1", "2", "3", "4", then value cannot be empty.</p>
value	string	<p>If type is set to "5", then value must be empty. Original value.</p> <p>Property behavior: - <i>required</i> if type is set to "1", "2", "3", "4" - <i>supported</i> if type is set to "5"</p>
newvalue	string	<p>Value to which the original value is mapped to.</p> <p>Property behavior: - <i>required</i></p>

¹ supported only for items having value type "numeric unsigned", "numeric float".

² supported only for items having value type "character".

valuemap.create

Description

object `valuemap.create(object/array valuemaps)`

This method allows to create new value maps.

Note:

This method is only available to *Super admin* user type. Permissions to call the method can be revoked in user role settings. See [User roles](#) for more information.

Parameters

(object/array) Value maps to create.

The method accepts value maps with the **standard value map properties**.

Return values

(object) Returns an object containing the IDs of the created value maps the `valuemapids` property. The order of the returned IDs matches the order of the passed value maps.

Examples

Creating a value map

Create one value map with two mappings.

Request:

```
{
  "jsonrpc": "2.0",
  "method": "valuemap.create",
  "params": {
    "hostid": "50009",
    "name": "Service state",
    "mappings": [
      {
        "type": "1",
        "value": "1",
        "newvalue": "Up"
      },
      {
        "type": "5",
        "newvalue": "Down"
      }
    ]
  },
  "id": 1
}
```

Response:

```
{
  "jsonrpc": "2.0",
  "result": {
    "valuemapids": [
      "1"
    ]
  },
  "id": 1
}
```

Source

`CValueMap::create()` in `ui/include/classes/api/services/CValueMap.php`.

valuemap.delete

Description

object `valuemap.delete(array valuemapids)`

This method allows to delete value maps.

Note:

This method is only available to *Super admin* user type. Permissions to call the method can be revoked in user role settings. See **User roles** for more information.

Parameters

(array) IDs of the value maps to delete.

Return values

(object) Returns an object containing the IDs of the deleted value maps under the `valuemapids` property.

Examples

Deleting multiple value maps

Delete two value maps.

Request:

```
{
  "jsonrpc": "2.0",
  "method": "valuemap.delete",
  "params": [
    "1",
    "2"
  ],
  "id": 1
}
```

Response:

```
{
  "jsonrpc": "2.0",
  "result": {
    "valuemapids": [
      "1",
      "2"
    ]
  },
  "id": 1
}
```

Source

`CValueMap::delete()` in `ui/include/classes/api/services/CValueMap.php`.

valuemap.get

Description

`integer/array valuemap.get(object parameters)`

The method allows to retrieve value maps according to the given parameters.

Note:

This method is available to users of any type. Permissions to call the method can be revoked in user role settings. See [User roles](#) for more information.

Parameters

(object) Parameters defining the desired output.

The method supports the following parameters.

Parameter	Type	Description
<code>valuemapids</code>	ID/array	Return only value maps with the given IDs.
<code>selectMappings</code>	query	Return the value mappings for current value map in the <code>mappings</code> property.
<code>sortfield</code>	string/array	Supports <code>count</code> . Sort the result by the given properties.
<code>countOutput</code>	boolean	Possible values: <code>valuemapid</code> , <code>name</code> . These parameters being common for all get methods are described in detail in the reference commentary .
<code>editable</code>	boolean	
<code>excludeSearch</code>	boolean	

Parameter	Type	Description
filter	object	
limit	integer	
output	query	
preservekeys	boolean	
search	object	
searchByAny	boolean	
searchWildcardsEnabled	boolean	
sortorder	string/array	
startSearch	boolean	

Return values

(integer/array) Returns either:

- an array of objects;
- the count of retrieved objects, if the `countOutput` parameter has been used.

Examples

Retrieving value maps

Retrieve all configured value maps.

Request:

```
{
  "jsonrpc": "2.0",
  "method": "valuemap.get",
  "params": {
    "output": "extend"
  },
  "id": 1
}
```

Response:

```
{
  "jsonrpc": "2.0",
  "result": [
    {
      "valuemapid": "4",
      "name": "APC Battery Replacement Status"
    },
    {
      "valuemapid": "5",
      "name": "APC Battery Status"
    },
    {
      "valuemapid": "7",
      "name": "Dell Open Manage System Status"
    }
  ],
  "id": 1
}
```

Retrieve one value map with its mappings.

Request:

```
{
  "jsonrpc": "2.0",
  "method": "valuemap.get",
  "params": {
    "output": "extend",
    "selectMappings": "extend",
    "valuemapids": ["4"]
  }
}
```

```
},
  "id": 1
}
```

Response:

```
{
  "jsonrpc": "2.0",
  "result": [
    {
      "valuemapid": "4",
      "name": "APC Battery Replacement Status",
      "mappings": [
        {
          "type": "0",
          "value": "1",
          "newvalue": "unknown"
        },
        {
          "type": "0",
          "value": "2",
          "newvalue": "notInstalled"
        },
        {
          "type": "0",
          "value": "3",
          "newvalue": "ok"
        },
        {
          "type": "0",
          "value": "4",
          "newvalue": "failed"
        },
        {
          "type": "0",
          "value": "5",
          "newvalue": "highTemperature"
        },
        {
          "type": "0",
          "value": "6",
          "newvalue": "replaceImmediately"
        },
        {
          "type": "0",
          "value": "7",
          "newvalue": "lowCapacity"
        }
      ]
    }
  ],
  "id": 1
}
```

Source

CValueMap::get() in *ui/include/classes/api/services/CValueMap.php*.

valuemap.update

Description

object `valuemap.update(object/array valuemaps)`

This method allows to update existing value maps.

Note:

This method is only available to *Super admin* user type. Permissions to call the method can be revoked in user role settings. See [User roles](#) for more information.

Parameters

(object/array) **Value map properties** to be updated.

The `valuemapid` property must be defined for each value map, all other properties are optional. Only the passed properties will be updated, all others will remain unchanged.

Return values

(object) Returns an object containing the IDs of the updated value maps under the `valuemapids` property.

Examples**Changing value map name**

Change value map name to "Device status".

Request:

```
{
  "jsonrpc": "2.0",
  "method": "valuemap.update",
  "params": {
    "valuemapid": "2",
    "name": "Device status"
  },
  "id": 1
}
```

Response:

```
{
  "jsonrpc": "2.0",
  "result": {
    "valuemapids": [
      "2"
    ]
  },
  "id": 1
}
```

Changing mappings for one value map.

Request:

```
{
  "jsonrpc": "2.0",
  "method": "valuemap.update",
  "params": {
    "valuemapid": "2",
    "mappings": [
      {
        "type": "0",
        "value": "0",
        "newvalue": "Online"
      },
      {
        "type": "0",
        "value": "1",
        "newvalue": "Offline"
      }
    ]
  },
  "id": 1
}
```

Response:

```
{
  "jsonrpc": "2.0",
  "result": {
    "valuemapids": [
      "2"
    ]
  },
  "id": 1
}
```

Source

CValueMap::update() in `ui/include/classes/api/services/CValueMap.php`.

Web scenario

This class is designed to work with web scenarios.

Object references:

- [Web scenario](#)
- [Web scenario tag](#)
- [Scenario step](#)
- [HTTP field](#)

Available methods:

- [httpstest.create](#) - create new web scenarios
- [httpstest.delete](#) - delete web scenarios
- [httpstest.get](#) - retrieve web scenarios
- [httpstest.update](#) - update web scenarios

Web scenario object

The following objects are directly related to the webcheck API.

Web scenario

The web scenario object has the following properties.

Property	Type	Description
httpstestid	ID	ID of the web scenario. Property behavior: - <i>read-only</i> - <i>required</i> for update operations
hostid	ID	ID of the host that the web scenario belongs to. Property behavior: - <i>constant</i> - <i>required</i> for create operations
name	string	Name of the web scenario. Property behavior: - <i>required</i> for create operations
agent	string	User agent string that will be used by the web scenario.
authentication	integer	Default: Zabbix Authentication method that will be used by the web scenario. Possible values: 0 - (<i>default</i>) none; 1 - basic HTTP authentication; 2 - NTLM authentication.

Property	Type	Description
delay	string	Execution interval of the web scenario. Accepts seconds or time unit with suffix (e.g., 30s, 1m, 2h, 1d), or a user macro. Default: 1m.
headers	array	HTTP headers that will be sent when performing a request.
http_password	string	Password used for basic HTTP or NTLM authentication.
http_proxy	string	Proxy that will be used by the web scenario given as <i>http://[username[:password]@]proxy.example.com[:port]</i> .
http_user	string	User name used for basic HTTP or NTLM authentication.
retries	integer	Number of times a web scenario will try to execute each step before failing. Default: 1.
ssl_cert_file	string	Name of the SSL certificate file used for client authentication (must be in PEM format).
ssl_key_file	string	Name of the SSL private key file used for client authentication (must be in PEM format).
ssl_key_password	string	SSL private key password.
status	integer	Whether the web scenario is enabled. Possible values: 0 - (<i>default</i>) enabled; 1 - disabled.
templateid	ID	ID of the parent template web scenario. Property behavior: - <i>read-only</i>
variables	array	Web scenario variables .
verify_host	integer	Whether to validate that the host name for the connection matches the one in the host's certificate. Possible values: 0 - (<i>default</i>) skip host verification; 1 - verify host.
verify_peer	integer	Whether to validate that the host's certificate is authentic. Possible values: 0 - (<i>default</i>) skip peer verification; 1 - verify peer.
uuid	string	Global unique identifier, used for linking imported web scenarios to already existing ones. Auto-generated, if not given. Property behavior: - <i>supported</i> if the web scenario belongs to a template

Web scenario tag

The web scenario tag object has the following properties.

Property	Type	Description
tag	string	Web scenario tag name. Property behavior: - <i>required</i>
value	string	Web scenario tag value.

Scenario step

The scenario step object defines a specific web scenario check. It has the following properties.

Property	Type	Description
name	string	Name of the scenario step.
no	integer	Sequence number of the step in a web scenario. Property behavior: - <i>required</i>
url	string	URL to be checked. Property behavior: - <i>required</i>
follow_redirects	integer	Whether to follow HTTP redirects. Possible values: 0 - don't follow redirects; 1 - (<i>default</i>) follow redirects.
headers	array	HTTP headers that will be sent when performing a request. Scenario step headers will overwrite headers specified for the web scenario.
posts	string/array	HTTP POST variables as a string (raw post data) or as an array of HTTP fields (form field data).
required	string	Text that must be present in the response.
retrieve_mode	integer	Part of the HTTP response that the scenario step must retrieve. Possible values: 0 - (<i>default</i>) only body; 1 - only headers; 2 - headers and body.
status_codes	string	Ranges of required HTTP status codes, separated by commas.
timeout	string	Request timeout in seconds. Accepts seconds, time unit with suffix, or a user macro. Default: 15s. Maximum: 1h. Minimum: 1s.
variables	array	Scenario step variables .
query_fields	array	Query fields - array of HTTP fields that will be added to URL when performing a request.

HTTP field

The HTTP field object defines the name and value that is used to specify the web scenario variables, HTTP headers, and POST fields or query fields. It has the following properties.

Property	Type	Description
name	string	Name of header/variable/POST or GET field. Property behavior: - <i>required</i>
value	string	Value of header/variable/POST or GET field. Property behavior: - <i>required</i>

httpstest.create

Description

```
object httpstest.create(object/array webScenarios)
```

This method allows to create new web scenarios.

Note:

Creating a web scenario will automatically create a set of **web monitoring items**.

Note:

This method is only available to *Admin* and *Super admin* user types. Permissions to call the method can be revoked in user role settings. See **User roles** for more information.

Parameters

(object/array) Web scenarios to create.

Additionally to the **standard web scenario properties**, the method accepts the following parameters.

Parameter	Type	Description
steps	array	Scenario steps. Parameter behavior: - <i>required</i>
tags	array	Web scenario tags.

Return values

(object) Returns an object containing the IDs of the created web scenarios under the `httptestids` property. The order of the returned IDs matches the order of the passed web scenarios.

Examples

Creating a web scenario

Create a web scenario to monitor the company home page. The scenario will have two steps, to check the home page and the "About" page and make sure they return the HTTP status code 200.

Request:

```
{
  "jsonrpc": "2.0",
  "method": "httptest.create",
  "params": {
    "name": "Homepage check",
    "hostid": "10085",
    "steps": [
      {
        "name": "Homepage",
        "url": "http://example.com",
        "status_codes": "200",
        "no": 1
      },
      {
        "name": "Homepage / About",
        "url": "http://example.com/about",
        "status_codes": "200",
        "no": 2
      }
    ]
  },
  "id": 1
}
```

Response:

```
{
  "jsonrpc": "2.0",
  "result": {
    "httptestids": [
      "5"
    ]
  }
}
```

```
    },  
    "id": 1  
  }  
}
```

See also

- [Scenario step](#)

Source

CHttpTest::create() in *ui/include/classes/api/services/CHttpTest.php*.

httpstest.delete

Description

object httpstest.delete(array webScenarioIds)

This method allows to delete web scenarios.

Note:

This method is only available to *Admin* and *Super admin* user types. Permissions to call the method can be revoked in user role settings. See [User roles](#) for more information.

Parameters

(array) IDs of the web scenarios to delete.

Return values

(object) Returns an object containing the IDs of the deleted web scenarios under the `httpstestids` property.

Examples

Deleting multiple web scenarios

Delete two web scenarios.

Request:

```
{  
  "jsonrpc": "2.0",  
  "method": "httpstest.delete",  
  "params": [  
    "2",  
    "3"  
  ],  
  "id": 1  
}
```

Response:

```
{  
  "jsonrpc": "2.0",  
  "result": {  
    "httpstestids": [  
      "2",  
      "3"  
    ]  
  },  
  "id": 1  
}
```

Source

CHttpTest::delete() in *ui/include/classes/api/services/CHttpTest.php*.

httptest.get

Description

integer/array httptest.get(object parameters)

The method allows to retrieve web scenarios according to the given parameters.

Note:

This method is available to users of any type. Permissions to call the method can be revoked in user role settings. See [User roles](#) for more information.

Parameters

(object) Parameters defining the desired output.

The method supports the following parameters.

Parameter	Type	Description
groupids	ID/array	Return only web scenarios that belong to the given host groups.
hostids	ID/array	Return only web scenarios that belong to the given hosts.
httptestids	ID/array	Return only web scenarios with the given IDs.
inherited	boolean	If set to true return only web scenarios inherited from a template.
monitored	boolean	If set to true return only enabled web scenarios that belong to monitored hosts.
templated	boolean	If set to true return only web scenarios that belong to templates.
templateids	ID/array	Return only web scenarios that belong to the given templates.
expandName	flag	Expand macros in the name of the web scenario.
expandStepName	flag	Expand macros in the names of scenario steps.
evaltype	integer	Rules for tag searching. Possible values: 0 - (default) And/Or; 2 - Or.
tags	array	Return only web scenarios with given tags. Exact match by tag and case-sensitive or case-insensitive search by tag value depending on operator value. Format: [{"tag": "<tag>", "value": "<value>", "operator": "<operator>"}, ...]. An empty array returns all web scenarios. Possible operator types: 0 - (default) Like; 1 - Equal; 2 - Not like; 3 - Not equal 4 - Exists; 5 - Not exists.
selectHosts	query	Return the hosts that the web scenario belongs to as an array in the hosts property.
selectSteps	query	Return web scenario steps in the steps property. Supports count.
selectTags	query	Return web scenario tags in the tags property.
sortfield	string/array	Sort the result by the given properties.
countOutput	boolean	Possible values: httptestid , name . These parameters being common for all get methods are described in detail in the reference commentary .
editable	boolean	
excludeSearch	boolean	
filter	object	
limit	integer	
output	query	

Parameter	Type	Description
preservekeys	boolean	
search	object	
searchByAny	boolean	
searchWildcardsEnabled	boolean	
sortorder	string/array	
startSearch	boolean	

Return values

(integer/array) Returns either:

- an array of objects;
- the count of retrieved objects, if the `countOutput` parameter has been used.

Examples

Retrieving a web scenario

Retrieve all data about web scenario "4".

Request:

```
{
  "jsonrpc": "2.0",
  "method": "httptest.get",
  "params": {
    "output": "extend",
    "selectSteps": "extend",
    "httptestids": "9"
  },
  "id": 1
}
```

Response:

```
{
  "jsonrpc": "2.0",
  "result": [
    {
      "httptestid": "9",
      "name": "Homepage check",
      "delay": "1m",
      "status": "0",
      "variables": [],
      "agent": "Zabbix",
      "authentication": "0",
      "http_user": "",
      "http_password": "",
      "hostid": "10084",
      "templateid": "0",
      "http_proxy": "",
      "retries": "1",
      "ssl_cert_file": "",
      "ssl_key_file": "",
      "ssl_key_password": "",
      "verify_peer": "0",
      "verify_host": "0",
      "headers": [],
      "steps": [
        {
          "httpstepid": "36",
          "httptestid": "9",
          "name": "Homepage",
          "no": "1",
          "url": "http://example.com",

```

```

        "timeout": "15s",
        "posts": "",
        "required": "",
        "status_codes": "200",
        "variables": [
            {
                "name": "{var}",
                "value": "12"
            }
        ],
        "follow_redirects": "1",
        "retrieve_mode": "0",
        "headers": [],
        "query_fields": []
    },
    {
        "httpstepid": "37",
        "httptestid": "9",
        "name": "Homepage / About",
        "no": "2",
        "url": "http://example.com/about",
        "timeout": "15s",
        "posts": "",
        "required": "",
        "status_codes": "200",
        "variables": [],
        "follow_redirects": "1",
        "retrieve_mode": "0",
        "headers": [],
        "query_fields": []
    }
]
    },
    "id": 1
}

```

See also

- [Host](#)
- [Scenario step](#)

Source

CHttpTest::get() in `ui/include/classes/api/services/CHttpTest.php`.

httpstest.update

Description

object httpstest.update(object/array webScenarios)

This method allows to update existing web scenarios.

Note:

This method is only available to *Admin* and *Super admin* user types. Permissions to call the method can be revoked in user role settings. See [User roles](#) for more information.

Parameters

(object/array) Web scenario properties to be updated.

The `httpstestid` property must be defined for each web scenario, all other properties are optional. Only the passed properties will be updated, all others will remain unchanged.

Additionally to the [standard web scenario properties](#), the method accepts the following parameters.

Parameter	Type	Description
steps	array	Scenario steps to replace existing steps.
tags	array	Web scenario tags .

Return values

(object) Returns an object containing the IDs of the updated web scenarios under the `httptestid` property.

Examples

Enabling a web scenario

Enable a web scenario, that is, set its status to "0".

Request:

```
{
  "jsonrpc": "2.0",
  "method": "httptest.update",
  "params": {
    "httptestid": "5",
    "status": 0
  },
  "id": 1
}
```

Response:

```
{
  "jsonrpc": "2.0",
  "result": {
    "httptestids": [
      "5"
    ]
  },
  "id": 1
}
```

See also

- [Scenario step](#)

Source

`CHttpTest::update()` in `ui/include/classes/api/services/CHttpTest.php`.

Appendix 1. Reference commentary

Notation Data types

The Zabbix API supports the following data types as input:

Type	Description
ID	A unique identifier used to reference an entity.
boolean	A boolean value (either <code>true</code> or <code>false</code>).
flag	A value that is considered to be <code>true</code> if passed and not equal to <code>null</code> ; otherwise, the value is considered to be <code>false</code> .
integer	A whole number.
float	A floating point number.
string	A text string.
text	A longer text string.
timestamp	A Unix timestamp.
array	An ordered sequence of values (a plain array).
object	An associative array.

Type	Description
query	A value that defines the data to be returned. The value can be defined as an array of property names (to return only specific properties), or as one of the predefined values: <i>extend</i> - returns all object properties; <i>count</i> - returns the number of retrieved records, supported only by certain subselects.

Attention:

Zabbix API always returns values as strings or arrays only.

Property behavior

Some of the object properties are marked with short labels to describe their behavior. The following labels are used:

- *read-only* - the value of the property is set automatically and cannot be defined or changed by the user, even in some specific conditions (e.g., *read-only* for inherited objects or discovered objects);
- *write-only* - the value of the property can be set, but cannot be accessed after;
- *constant* - the value of the property can be set when creating an object, but cannot be changed after;
- *supported* - the value of the property is not required to be set, but is allowed to be set in some specific conditions (e.g., *supported* if *ttype* is set to "Simple check", "External check", "SSH agent", "TELNET agent", or "HTTP agent");
- *required* - the value of the property is required to be set for all operations (except get operations) or in some specific conditions (e.g., *required* for create operations; *required* if *operationtype* is set to "global script" and *opcommand_hst* is not set).

Note:

For update operations a property is considered as "set" when setting it during the update operation.

Properties that are not marked with labels are optional.

Parameter behavior

Some of the operation parameters are marked with short labels to describe their behavior for the operation. The following labels are used:

- *read-only* - the value of the parameter is set automatically and cannot be defined or changed by the user, even in some specific conditions (e.g., *read-only* for inherited objects or discovered objects);
- *write-only* - the value of the parameter can be set, but cannot be accessed after;
- *supported* - the value of the parameter is not required to be set, but is allowed to be set in some specific conditions (e.g., *supported* if *operating_mode* of Proxy object is set to "passive proxy");
- *required* - the value of the parameter is required to be set.

Parameters that are not marked with labels are optional.

Reserved ID value "0" Reserved ID value "0" can be used to filter elements and to remove referenced objects. For example, to remove a referenced proxy from a host, *proxyid* should be set to 0 ("*proxyid*": "0") or to filter hosts monitored by server option *proxyids* should be set to 0 ("*proxyids*": "0").

Common "get" method parameters The following parameters are supported by all get methods:

Parameter	Type	Description
<i>countOutput</i>	boolean	Return the number of records in the result instead of the actual data.
<i>editable</i>	boolean	If set to <code>true</code> , return only objects that the user has write permissions to. Default: <code>false</code> .
<i>excludeSearch</i>	boolean	Return results that do not match the criteria given in the <i>search</i> parameter.
<i>filter</i>	object	Return only those results that exactly match the given filter. Accepts an object, where the keys are property names, and the values are either a single value or an array of values to match against.
<i>limit</i>	integer	Does not support properties of text data type . Limit the number of records returned.

Parameter	Type	Description
output	query	Object properties to be returned.
preservekeys	boolean	Default: extend. Use IDs as keys in the resulting array.
search	object	Return results that match the given pattern (case-insensitive). Accepts an object, where the keys are property names, and the values are strings to search for. If no additional options are given, this will perform a LIKE "%...%" search.
searchByAny	boolean	Supports only properties of string and text data type. If set to true, return results that match any of the criteria given in the filter or search parameter instead of all of them.
searchWildcardsEnabled	boolean	Default: false. If set to true, enables the use of "*" as a wildcard character in the search parameter.
sortfield	string/array	Default: false. Sort the result by the given properties. Refer to a specific API get method description for a list of properties that can be used for sorting. Macros are not expanded before sorting.
sortorder	string/array	If no value is specified, data will be returned unsorted. Order of sorting. If an array is passed, each value will be matched to the corresponding property given in the sortfield parameter.
startSearch	boolean	Possible values: ASC - (default) ascending; DESC - descending. The search parameter will compare the beginning of fields, that is, perform a LIKE "...%" search instead.
		Ignored if searchWildcardsEnabled is set to true.

Examples User permission check

Does the user have permission to write to hosts whose names begin with "MySQL" or "Linux" ?

Request:

```
{
  "jsonrpc": "2.0",
  "method": "host.get",
  "params": {
    "countOutput": true,
    "search": {
      "host": ["MySQL", "Linux"]
    },
    "editable": true,
    "startSearch": true,
    "searchByAny": true
  },
  "id": 1
}
```

Response:

```
{
  "jsonrpc": "2.0",
  "result": "0",
  "id": 1
}
```

Note:

Zero result means no hosts with read/write permissions.

Mismatch counting

Count the number of hosts whose names do not contain the substring "ubuntu"

Request:

```
{
  "jsonrpc": "2.0",
  "method": "host.get",
  "params": {
    "countOutput": true,
    "search": {
      "host": "ubuntu"
    },
    "excludeSearch": true
  },
  "id": 1
}
```

Response:

```
{
  "jsonrpc": "2.0",
  "result": "44",
  "id": 1
}
```

Searching for hosts using wildcards

Find hosts whose name contains word "server" and have interface ports "10050" or "10071". Sort the result by host name in descending order and limit it to 5 hosts.

Request:

```
{
  "jsonrpc": "2.0",
  "method": "host.get",
  "params": {
    "output": ["hostid", "host"],
    "selectInterfaces": ["port"],
    "filter": {
      "port": ["10050", "10071"]
    },
    "search": {
      "host": "*server*"
    },
    "searchWildcardsEnabled": true,
    "searchByAny": true,
    "sortfield": "host",
    "sortorder": "DESC",
    "limit": 5
  },
  "id": 1
}
```

Response:

```
{
  "jsonrpc": "2.0",
  "result": [
    {
      "hostid": "50003",
      "host": "WebServer-Tomcat02",
      "interfaces": [
```

```

        {
            "port": "10071"
        }
    ],
    {
        "hostid": "50005",
        "host": "WebServer-Tomcat01",
        "interfaces": [
            {
                "port": "10071"
            }
        ]
    },
    {
        "hostid": "50004",
        "host": "WebServer-Nginx",
        "interfaces": [
            {
                "port": "10071"
            }
        ]
    },
    {
        "hostid": "99032",
        "host": "MySQL server 01",
        "interfaces": [
            {
                "port": "10050"
            }
        ]
    },
    {
        "hostid": "99061",
        "host": "Linux server 01",
        "interfaces": [
            {
                "port": "10050"
            }
        ]
    }
],
    "id": 1
}

```

Searching for hosts using wildcards with "preservekeys"

If you add the parameter "preservekeys" to the previous request, the result is returned as an associative array, where the keys are the id of the objects.

Request:

```

{
    "jsonrpc": "2.0",
    "method": "host.get",
    "params": {
        "output": ["hostid", "host"],
        "selectInterfaces": ["port"],
        "filter": {
            "port": ["10050", "10071"]
        },
        "search": {
            "host": "*server*"
        },
    },
}

```



```

    "searchWildcardsEnabled": true,
    "searchByAny": true,
    "sortfield": "host",
    "sortorder": "DESC",
    "limit": 5,
    "preservekeys": true
  },
  "id": 1
}

```

Response:

```

{
  "jsonrpc": "2.0",
  "result": {
    "50003": {
      "hostid": "50003",
      "host": "WebServer-Tomcat02",
      "interfaces": [
        {
          "port": "10071"
        }
      ]
    },
    "50005": {
      "hostid": "50005",
      "host": "WebServer-Tomcat01",
      "interfaces": [
        {
          "port": "10071"
        }
      ]
    },
    "50004": {
      "hostid": "50004",
      "host": "WebServer-Nginx",
      "interfaces": [
        {
          "port": "10071"
        }
      ]
    },
    "99032": {
      "hostid": "99032",
      "host": "MySQL server 01",
      "interfaces": [
        {
          "port": "10050"
        }
      ]
    },
    "99061": {
      "hostid": "99061",
      "host": "Linux server 01",
      "interfaces": [
        {
          "port": "10050"
        }
      ]
    }
  },
  "id": 1
}

```

Appendix 2. Changes from 7.2 to 7.4

Backward incompatible changes

Other changes and bug fixes

21 Extensions

Overview Although Zabbix offers a multiplicity of features, there is always room for additional functionality. Extensions are a convenient way of modifying and enhancing the monitoring capabilities of Zabbix without changing its source code.

You can extend Zabbix functionality either by using built-in extension options (trapper items, user parameters, etc.) or by using or creating custom extensions (loadable modules, plugins, etc.).

This section provides an overview with references to all the options for extending Zabbix.

Data collection with custom commands Trapper items

Trapper items are items that accept incoming data instead of querying for it. Trapper items are useful for sending specific data to Zabbix server or proxy, for example, periodic availability and performance data in the case of long-running user scripts. Sending data to Zabbix server or proxy is possible using the **Zabbix sender** utility or Zabbix sender **protocol**. Sending data to Zabbix server is also possible using the **history.push** API method.

External checks

An **external check** is an item for executing checks by running an executable, for example, a **shell script** or a binary.

External checks are executed by Zabbix server or proxy (when host is monitored by proxy), and do not require an agent running on the host being monitored.

User parameters

A **user parameter** is a user-defined command (associated with a user-defined key) that, when executed, can retrieve the data you need from the host where Zabbix agent is running. User parameters are useful for configuring agent or agent 2 items that are not predefined in Zabbix.

system.run[] Zabbix agent items

system.run[] Zabbix **agent item** is an item for a user-defined command (associated with a predefined key **system.run[]**, for example, **system.run[myscript.sh]**) that can be executed on the host where Zabbix agent is running.

Note: **system.run[]** items are disabled by default and, if used, must be enabled (**allowed**) and defined in the Zabbix agent or agent 2 configuration file (**AllowKey** configuration parameter).

Attention:

User-defined commands in items such as external checks, user parameters and **system.run[]** Zabbix agent items are executed from the OS user that is used to run Zabbix components. To execute these commands, this user must have the necessary permissions.

HTTP agent items

HTTP agent item is an item for executing data requests over HTTP/HTTPS. HTTP agent items are useful for sending requests to HTTP endpoints to retrieve data from services such as *Elasticsearch* and *OpenWeatherMap*, for checking the status of Zabbix API or the status of Apache or Nginx web server, etc. HTTP agent items (with trapping enabled) can also function as **trapper items**.

Script items

A **script item** is an item for executing user-defined JavaScript code that retrieves data over HTTP/HTTPS. Script items are useful when the functionality provided by HTTP agent items is not enough. For example, in demanding data collection scenarios that require multiple steps or complex logic, a script item can be configured to make an HTTP call, then process the data received, and then pass the transformed value to a second HTTP call.

Note:

HTTP agent items and script items are supported by Zabbix server and proxy, and do not require an agent running on the host being monitored.

Advanced extensions Loadable modules

Loadable modules, written in C, are a versatile and performance-minded option for extending the functionality of Zabbix components (server, proxy, agent) on UNIX platforms. A loadable module is basically a shared library used by Zabbix daemon and loaded on startup. The library should contain certain functions, so that a Zabbix process may detect that the file is indeed a module it can load and work with.

Loadable modules have a number of benefits, including the ability to add new metrics or implement any other logic (for example, Zabbix **history data export**), great performance, and the option to develop, use and share the functionality they provide. It contributes to trouble-free maintenance and helps to deliver new functionality easier and independently of the Zabbix core code base.

Loadable modules are especially useful in a complex monitoring setup. When monitoring embedded systems, having a large number of monitored parameters or heavy scripts with complex logic or long startup time, extensions such as user parameters, `system.run[]` Zabbix agent items, and external checks will have an impact on performance. Loadable modules offer a way of extending Zabbix functionality without sacrificing performance.

Plugins

Plugins provide an alternative to loadable modules (written in C). However, plugins are a way to extend Zabbix agent 2 only.

A plugin is a Go package that defines the structure and implements one or several plugin interfaces (*Exporter*, *Collector*, *Configurator*, *Runner*, *Watcher*). Two types of Zabbix agent 2 plugins are supported:

- **Built-in plugins** (supported since Zabbix 4.4.0)
- **Loadable plugins** (supported since Zabbix 6.0.0)

See the list of **built-in plugins**.

For instructions and tutorials on writing your own plugins, see **Developer center**.

Alert customization Webhooks

A **webhook** is a Zabbix **media type** that provides an option to extend Zabbix alerting capabilities to external software such as helpdesk systems, chats, or messengers. Similarly to script items, webhooks are useful for making HTTP calls using custom JavaScript code, for example, to push notifications to different platforms such as Microsoft Teams, Discord, and Jira. It is also possible to return some data (for example, about created helpdesk tickets) that is then displayed in Zabbix.

Existing webhooks are available in the Zabbix **Git repository**. For custom webhook development, see **Webhook development guidelines**.

Alert scripts

An **alert script** is a Zabbix **media type** that provides an option to create an alternative way (script) to handle Zabbix alerts. Alert scripts are useful if you are not satisfied with the existing media types for sending alerts in Zabbix.

Frontend customization Custom themes

It is possible to change Zabbix frontend visual appearance by using custom themes. See the **instructions** on creating and applying your own themes.

Frontend modules

Frontend modules provide an option to extend Zabbix frontend functionality by adding third-party modules or by developing your own. With frontend modules you can add new menu items, their respective views, actions, etc.

Global scripts A **global script** is a user-defined set of commands that can be executed on a monitoring target (by shell (/bin/sh) interpreter), depending on the configured scope and user permissions. Global scripts can be configured for the following actions:

- **Action operation**
- **Manual host action**
- **Manual event action**

Global scripts are useful in many cases. For example, if configured for action operations or manual host actions, you can use global scripts to automatically or manually execute **remote commands** such as restarting an application (web server, middleware, CRM,

etc.) or freeing disk space (removing older files, cleaning /tmp, etc). Or, another example, if configured for manual event actions, you can use global scripts to manage problem tickets in external systems.

Global scripts can be executed by Zabbix server, proxy or agent.

Attention:

User-defined commands are executed from the OS user that is used to run Zabbix components. To execute these commands, this user must have the necessary permissions.

Zabbix API **Zabbix API** is an HTTP-based API that is part of Zabbix frontend. With Zabbix API, you can do any of the following operations:

- Programmatically retrieve and modify the configuration of Zabbix.
- Import and export Zabbix configuration.
- Access Zabbix historical and trend data.
- Configure applications to work with Zabbix.
- Integrate Zabbix with third-party software.
- Automate routine tasks.

Zabbix API consists of a multiplicity of methods that are nominally grouped into separate APIs. Each method performs a specific task. For the available methods, as well as an overview of the functions provided by Zabbix API, see Zabbix API [Method reference](#).

1 Loadable modules

Overview

Loadable modules offer a performance-minded option for extending Zabbix functionality.

You can **extend** Zabbix functionality in many ways, for example, with **user parameters**, **external checks**, and `system.run []` **Zabbix agent items**. These work very well, but have one major drawback, namely `fork()`. Zabbix has to fork a new process every time it handles a user metric, which is not good for performance. It is not a big deal normally, however it could be a serious issue when monitoring embedded systems, having a large number of monitored parameters or heavy scripts with complex logic or long startup time.

Support of loadable modules offers ways for extending Zabbix agent, server and proxy without sacrificing performance.

A loadable module is basically a shared library used by Zabbix daemon and loaded on startup. The library should contain certain functions, so that a Zabbix process may detect that the file is indeed a module it can load and work with.

Loadable modules have a number of benefits. Great performance and ability to implement any logic are very important, but perhaps the most important advantage is the ability to develop, use and share Zabbix modules. It contributes to trouble-free maintenance and helps to deliver new functionality easier and independently of the Zabbix core code base.

Module licensing and distribution in binary form is governed by the AGPL-3.0 license (modules are linking with Zabbix in runtime and are using Zabbix headers; the whole Zabbix code is licensed under AGPL-3.0 license since Zabbix 7.0). Binary compatibility is not guaranteed by Zabbix.

Module API stability is guaranteed during one Zabbix LTS (Long Term Support) [release](#) cycle. Stability of Zabbix API is not guaranteed (technically it is possible to call Zabbix internal functions from a module, but there is no guarantee that such modules will work).

Module API

In order for a shared library to be treated as a Zabbix module, it should implement and export several functions. There are currently six functions in the Zabbix module API, only one of which is mandatory and the other five are optional.

Mandatory interface

The only mandatory function is **zbx_module_api_version()**:

```
int zbx_module_api_version(void);
```

This function should return the API version implemented by this module and in order for the module to be loaded this version must match module API version supported by Zabbix. Version of module API supported by Zabbix is `ZBX_MODULE_API_VERSION`. So this function should return this constant. Old constant `ZBX_MODULE_API_VERSION_ONE` used for this purpose is now defined to equal `ZBX_MODULE_API_VERSION` to preserve source compatibility, but it's usage is not recommended.

Optional interface

The optional functions are `zbx_module_init()`, `zbx_module_item_list()`, `zbx_module_item_timeout()`, `zbx_module_history_write_cbs()` and `zbx_module_uninit()`:

```
int zbx_module_init(void);
```

This function should perform the necessary initialization for the module (if any). If successful, it should return `ZBX_MODULE_OK`. Otherwise, it should return `ZBX_MODULE_FAIL`. In the latter case Zabbix will not start.

```
ZBX_METRIC *zbx_module_item_list(void);
```

This function should return a list of items supported by the module. Each item is defined in a `ZBX_METRIC` structure, see the section below for details. The list is terminated by a `ZBX_METRIC` structure with "key" field of `NULL`.

```
void zbx_module_item_timeout(int timeout);
```

If module exports `zbx_module_item_list()` then this function is used by Zabbix to specify the timeout settings in Zabbix configuration file that the item checks implemented by the module should obey. Here, the "timeout" parameter is in seconds.

```
ZBX_HISTORY_WRITE_CBS zbx_module_history_write_cbs(void);
```

This function should return callback functions Zabbix server will use to export history of different data types. Callback functions are provided as fields of `ZBX_HISTORY_WRITE_CBS` structure, fields can be `NULL` if module is not interested in the history of certain type.

```
int zbx_module_uninit(void);
```

This function should perform the necessary uninitialization (if any) like freeing allocated resources, closing file descriptors, etc.

All functions are called once on Zabbix startup when the module is loaded, with the exception of `zbx_module_uninit()`, which is called once on Zabbix shutdown when the module is unloaded.

Defining items

Each item is defined in a `ZBX_METRIC` structure:

```
typedef struct
{
    char *key;
    unsigned flags;
    int (*function)();
    char *test_param;
}
ZBX_METRIC;
```

Here, **key** is the item key (e.g., "dummy.random"), **flags** is either `CF_HAVEPARAMS` or 0 (depending on whether the item accepts parameters or not), **function** is a C function that implements the item (e.g., "zbx_module_dummy_random"), and **test_param** is the parameter list to be used when Zabbix agent is started with the "-p" flag (e.g., "1,1000", can be `NULL`). An example definition may look like this:

```
static ZBX_METRIC keys[] =
{
    { "dummy.random", CF_HAVEPARAMS, zbx_module_dummy_random, "1,1000" },
    { NULL }
}
```

Each function that implements an item should accept two pointer parameters, the first one of type `AGENT_REQUEST` and the second one of type `AGENT_RESULT`:

```
int zbx_module_dummy_random(AGENT_REQUEST *request, AGENT_RESULT *result)
{
    ...

    SET_UI64_RESULT(result, from + rand() % (to - from + 1));

    return SYSINFO_RET_OK;
}
```

These functions should return `SYSINFO_RET_OK`, if the item value was successfully obtained. Otherwise, they should return `SYSINFO_RET_FAIL`. See example "dummy" module below for details on how to obtain information from `AGENT_REQUEST` and how to set information in `AGENT_RESULT`.

Attention:

History export via module is no longer supported by Zabbix proxy.

Module can specify functions to export history data by type: Numeric (float), Numeric (unsigned), Character, Text and Log:

```
typedef struct
{
    void    (*history_float_cb)(const ZBX_HISTORY_FLOAT *history, int history_num);
    void    (*history_integer_cb)(const ZBX_HISTORY_INTEGER *history, int history_num);
    void    (*history_string_cb)(const ZBX_HISTORY_STRING *history, int history_num);
    void    (*history_text_cb)(const ZBX_HISTORY_TEXT *history, int history_num);
    void    (*history_log_cb)(const ZBX_HISTORY_LOG *history, int history_num);
}
ZBX_HISTORY_WRITE_CB;
```

Each of them should take "history" array of "history_num" elements as arguments. Depending on history data type to be exported, "history" is an array of the following structures, respectively:

```
typedef struct
{
    zbx_uint64_t    itemid;
    int             clock;
    int             ns;
    double         value;
}
ZBX_HISTORY_FLOAT;
```

```
typedef struct
{
    zbx_uint64_t    itemid;
    int             clock;
    int             ns;
    zbx_uint64_t    value;
}
ZBX_HISTORY_INTEGER;
```

```
typedef struct
{
    zbx_uint64_t    itemid;
    int             clock;
    int             ns;
    const char      *value;
}
ZBX_HISTORY_STRING;
```

```
typedef struct
{
    zbx_uint64_t    itemid;
    int             clock;
    int             ns;
    const char      *value;
}
ZBX_HISTORY_TEXT;
```

```
typedef struct
{
    zbx_uint64_t    itemid;
    int             clock;
    int             ns;
    const char      *value;
    const char      *source;
    int             timestamp;
}
```

```

    int     logeventid;
    int     severity;
}
ZBX_HISTORY_LOG;

```

Callbacks will be used by Zabbix server history syncer processes in the end of history sync procedure after data is written into Zabbix database and saved in value cache.

Attention:

In case of internal error in history export module, it is recommended that module is written in such a way that it does not block whole monitoring until it recovers but discards data instead and allows Zabbix server to continue running.

Building modules

Modules are currently meant to be built inside Zabbix source tree, because the module API depends on some data structures that are defined in Zabbix headers.

The most important header for loadable modules is **include/module.h**, which defines these data structures. Other necessary system headers that help **include/module.h** to work properly are **stdlib.h** and **stdint.h**.

With this information in mind, everything is ready for the module to be built. The module should include **stdlib.h**, **stdint.h** and **module.h**, and the build script should make sure that these files are in the include path. See example "dummy" module below for details.

Another useful header is **include/zbxcommon.h**, which defines **zabbix_log()** function, which can be used for logging and debugging purposes.

Configuration parameters

Zabbix agent, server and proxy support two **parameters** to deal with modules:

- LoadModulePath - full path to the location of loadable modules
- LoadModule - module(s) to load at startup. The modules must be located in a directory specified by LoadModulePath or the path must precede the module name. If the preceding path is absolute (starts with '/') then LoadModulePath is ignored. It is allowed to include multiple LoadModule parameters.

For example, to extend Zabbix agent we could add the following parameters:

```

LoadModulePath=/usr/local/lib/zabbix/agent/
LoadModule=mariadb.so
LoadModule=apache.so
LoadModule=kernel.so
LoadModule=/usr/local/lib/zabbix/dummy.so

```

Upon agent startup it will load the mariadb.so, apache.so and kernel.so modules from the /usr/local/lib/zabbix/agent directory while dummy.so will be loaded from /usr/local/lib/zabbix. The agent will fail to start if a module is missing, in case of bad permissions or if a shared library is not a Zabbix module.

Frontend configuration

Loadable modules are supported by Zabbix agent, server and proxy. Therefore, item type in Zabbix frontend depends on where the module is loaded. If the module is loaded into the agent, then the item type should be "Zabbix agent" or "Zabbix agent (active)". If the module is loaded into server or proxy, then the item type should be "Simple check".

History export through Zabbix modules does not need any frontend configuration. If the module is successfully loaded by server and provides **zbx_module_history_write_cbs()** function which returns at least one non-NULL callback function then history export will be enabled automatically.

Dummy module

Zabbix includes a sample module written in C language. The module is located under src/modules/dummy:

```

alex@alex:~trunk/src/modules/dummy$ ls -l
-rw-rw-r-- 1 alex alex 9019 Apr 24 17:54 dummy.c
-rw-rw-r-- 1 alex alex  67 Apr 24 17:54 Makefile
-rw-rw-r-- 1 alex alex  245 Apr 24 17:54 README

```

The module is well documented, it can be used as a template for your own modules.

After ./configure has been run in the root of Zabbix source tree as described above, just run **make** in order to build **dummy.so**.

```

/*
** Zabbix
** Copyright (C) 2001-2020 Zabbix SIA
**
** This program is free software; you can redistribute it and/or modify
** it under the terms of the GNU General Public License as published by
** the Free Software Foundation; either version 2 of the License, or
** (at your option) any later version.
**
** This program is distributed in the hope that it will be useful,
** but WITHOUT ANY WARRANTY; without even the implied warranty of
** MERCHANTABILITY or FITNESS FOR A PARTICULAR PURPOSE. See the
** GNU General Public License for more details.
**
** You should have received a copy of the GNU General Public License
** along with this program; if not, write to the Free Software
** Foundation, Inc., 51 Franklin Street, Fifth Floor, Boston, MA 02110-1301, USA.
**/

###include <stdlib.h>
###include <string.h>
###include <time.h>
###include <stdint.h>

###include "module.h"

/* the variable keeps timeout setting for item processing */
static int item_timeout = 0;

/* module SHOULD define internal functions as static and use a naming pattern different from Zabbix intern
/* symbols (zbx_*) and loadable module API functions (zbx_module_*) to avoid conflicts
static int dummy_ping(AGENT_REQUEST *request, AGENT_RESULT *result);
static int dummy_echo(AGENT_REQUEST *request, AGENT_RESULT *result);
static int dummy_random(AGENT_REQUEST *request, AGENT_RESULT *result);

static ZBX_METRIC keys[] =
/* KEY          FLAG          FUNCTION      TEST PARAMETERS */
{
    {"dummy.ping",      0,          dummy_ping, NULL},
    {"dummy.echo",      CF_HAVEPARAMS, dummy_echo, "a message"},
    {"dummy.random",    CF_HAVEPARAMS, dummy_random, "1,1000"},
    {NULL}
};

/*****
*
* Function: zbx_module_api_version
*
* Purpose: returns version number of the module interface
*
* Return value: ZBX_MODULE_API_VERSION - version of module.h module is
*             compiled with, in order to load module successfully Zabbix
*             MUST be compiled with the same version of this header file
*
*****/
int zbx_module_api_version(void)
{
    return ZBX_MODULE_API_VERSION;
}

/*****
*
*
*****/

```



```

* Function: zbx_module_item_timeout *
* *
* Purpose: set timeout value for processing of items *
* *
* Parameters: timeout - timeout in seconds, 0 - no timeout set *
* *
*****/
void zbx_module_item_timeout(int timeout)
{
    item_timeout = timeout;
}

/*****
* *
* Function: zbx_module_item_list *
* *
* Purpose: returns list of item keys supported by the module *
* *
* Return value: list of item keys *
* *
*****/
ZBX_METRIC *zbx_module_item_list(void)
{
    return keys;
}

static int dummy_ping(AGENT_REQUEST *request, AGENT_RESULT *result)
{
    SET_UI64_RESULT(result, 1);

    return SYSINFO_RET_OK;
}

static int dummy_echo(AGENT_REQUEST *request, AGENT_RESULT *result)
{
    char *param;

    if (1 != request->nparam)
    {
        /* set optional error message */
        SET_MSG_RESULT(result, strdup("Invalid number of parameters."));
        return SYSINFO_RET_FAIL;
    }

    param = get_rparam(request, 0);

    SET_STR_RESULT(result, strdup(param));

    return SYSINFO_RET_OK;
}

/*****
* *
* Function: dummy_random *
* *
* Purpose: a main entry point for processing of an item *
* *
* Parameters: request - structure that contains item key and parameters *
*             request->key - item key without parameters *
*             request->nparam - number of parameters *
*             request->params[N-1] - pointers to item key parameters *
*             request->types[N-1] - item key parameters types: *

```

```

*          REQUEST_PARAMETER_TYPE_UNDEFINED (key parameter is empty) *
*          REQUEST_PARAMETER_TYPE_ARRAY (array) *
*          REQUEST_PARAMETER_TYPE_STRING (quoted or unquoted string) *
*
*          result - structure that will contain result *
*
* Return value: SYSINFO_RET_FAIL - function failed, item will be marked *
*                  as not supported by zabbix *
*          SYSINFO_RET_OK - success *
*
* Comment: get_rparam(request, N-1) can be used to get a pointer to the Nth *
*          parameter starting from 0 (first parameter). Make sure it exists *
*          by checking value of request->nparam. *
*          In the same manner get_rparam_type(request, N-1) can be used to *
*          get a parameter type. *
*
*****/
static int dummy_random(AGENT_REQUEST *request, AGENT_RESULT *result)
{
    char *param1, *param2;
    int from, to;

    if (2 != request->nparam)
    {
        /* set optional error message */
        SET_MSG_RESULT(result, strdup("Invalid number of parameters.));
        return SYSINFO_RET_FAIL;
    }

    param1 = get_rparam(request, 0);
    param2 = get_rparam(request, 1);

    /* there is no strict validation of parameters and types for simplicity sake */
    from = atoi(param1);
    to = atoi(param2);

    if (from > to)
    {
        SET_MSG_RESULT(result, strdup("Invalid range specified.));
        return SYSINFO_RET_FAIL;
    }

    SET_UI64_RESULT(result, from + rand() % (to - from + 1));

    return SYSINFO_RET_OK;
}

/*****
*
* Function: zbx_module_init *
*
* Purpose: the function is called on agent startup *
*          It should be used to call any initialization routines *
*
* Return value: ZBX_MODULE_OK - success *
*              ZBX_MODULE_FAIL - module initialization failed *
*
* Comment: the module won't be loaded in case of ZBX_MODULE_FAIL *
*
*****/
int zbx_module_init(void)
{

```

```

    /* initialization for dummy.random */
    srand(time(NULL));

    return ZBX_MODULE_OK;
}

/*****
 *
 * Function: zbx_module_uninit
 *
 * Purpose: the function is called on agent shutdown
 *          It should be used to cleanup used resources if there are any
 *
 * Return value: ZBX_MODULE_OK - success
 *              ZBX_MODULE_FAIL - function failed
 *****/
int zbx_module_uninit(void)
{
    return ZBX_MODULE_OK;
}

/*****
 *
 * Functions: dummy_history_float_cb
 *            dummy_history_integer_cb
 *            dummy_history_string_cb
 *            dummy_history_text_cb
 *            dummy_history_log_cb
 *
 * Purpose: callback functions for storing historical data of types float,
 *          integer, string, text and log respectively in external storage
 *
 * Parameters: history      - array of historical data
 *            history_num - number of elements in history array
 *****/
static void dummy_history_float_cb(const ZBX_HISTORY_FLOAT *history, int history_num)
{
    int i;

    for (i = 0; i < history_num; i++)
    {
        /* do something with history[i].itemid, history[i].clock, history[i].ns, history[i].value, ... */
    }
}

static void dummy_history_integer_cb(const ZBX_HISTORY_INTEGER *history, int history_num)
{
    int i;

    for (i = 0; i < history_num; i++)
    {
        /* do something with history[i].itemid, history[i].clock, history[i].ns, history[i].value, ... */
    }
}

static void dummy_history_string_cb(const ZBX_HISTORY_STRING *history, int history_num)
{
    int i;

    for (i = 0; i < history_num; i++)

```

```

    {
        /* do something with history[i].itemid, history[i].clock, history[i].ns, history[i].value, ... */
    }
}

static void dummy_history_text_cb(const ZBX_HISTORY_TEXT *history, int history_num)
{
    int i;

    for (i = 0; i < history_num; i++)
    {
        /* do something with history[i].itemid, history[i].clock, history[i].ns, history[i].value, ... */
    }
}

static void dummy_history_log_cb(const ZBX_HISTORY_LOG *history, int history_num)
{
    int i;

    for (i = 0; i < history_num; i++)
    {
        /* do something with history[i].itemid, history[i].clock, history[i].ns, history[i].value, ... */
    }
}

/*****
 *
 * Function: zbx_module_history_write_cbs
 *
 * Purpose: returns a set of module functions Zabbix will call to export
 *          different types of historical data
 *
 * Return value: structure with callback function pointers (can be NULL if
 *              module is not interested in data of certain types)
 *
 *****/
ZBX_HISTORY_WRITE_CBS zbx_module_history_write_cbs(void)
{
    static ZBX_HISTORY_WRITE_CBS dummy_callbacks =
    {
        dummy_history_float_cb,
        dummy_history_integer_cb,
        dummy_history_string_cb,
        dummy_history_text_cb,
        dummy_history_log_cb,
    };

    return dummy_callbacks;
}

```

The module exports three new items:

- `dummy.ping` - always returns '1'
- `dummy.echo[param1]` - returns the first parameter as it is, for example, `dummy.echo[ABC]` will return ABC
- `dummy.random[param1, param2]` - returns a random number within the range of param1-param2, for example, `dummy.random[1,1000000]`

Limitations

Support of loadable modules is implemented for the Unix platform only. It means that it does not work for Windows agents.

In some cases a module may need to read module-related configuration parameters from `zabbix_agentd.conf`. It is not supported currently. If you need your module to use some configuration parameters you should probably implement parsing of a module-specific configuration file.

2 Plugins

Overview

Plugins provide an option to extend the monitoring capabilities of Zabbix. Plugins are written in Go programming language and are supported by Zabbix agent 2 only. Plugins provide an alternative to **loadable modules** (written in C), and **other methods** for extending Zabbix functionality.

The following features are specific to agent 2 and its plugins:

- support of scheduled and flexible intervals for both passive and active checks;
- task queue management with respect to schedule and task concurrency;
- plugin-level timeouts;
- compatibility check of Zabbix agent 2 and its plugins on start up.

Since Zabbix 6.0, plugins don't have to be integrated into the agent 2 directly and can be added as loadable plugins, thus making the creation process of additional plugins for gathering new monitoring metrics easier.

This page lists Zabbix native and loadable plugins, and describes plugin configuration principles from the user perspective.

Note:

For instructions on writing your own plugins, see [Developer center](#) and [Example plugin for Zabbix agent 2](#).

For details on the communication process between Zabbix agent 2 and a loadable plugin as well as the metric collection process, see [Connection diagram](#).

Configuring plugins

This section provides common plugin configuration principles and best practices.

All plugins are configured using `Plugins.*` parameter, which can either be part of the Zabbix agent 2 **configuration file** or a plugin's own **configuration file**. If a plugin uses a separate configuration file, path to this file should be specified in the `Include` parameter of Zabbix agent 2 configuration file.

A typical plugin parameter has the following structure:

```
Plugins.<PluginName>.<Parameter>=<Value>
```

Additionally, there are two specific groups of parameters:

- `Plugins.<PluginName>.Default.<Parameter>=<Value>` used for defining **default parameter values**.
- `Plugins.<PluginName>.<SessionName>.<Parameter>=<Value>` used for defining separate sets of parameters for different monitoring targets via **named sessions**.

All parameter names should adhere to the following requirements:

- it is recommended to capitalize the names of your plugins;
- the parameter should be capitalized;
- special characters are not allowed;
- nesting isn't limited by a maximum level;
- the number of parameters is not limited.

For example, to perform **active checks** that do not have **Scheduling update interval** immediately after the agent restart only for the Uptime plugin, set `Plugins.Uptime.System.ForceActiveChecksOnStart=1` in the **configuration file**. Similarly, to set custom limit for **concurrent checks** for the CPU plugin, set the `Plugins.CPU.System.Capacity=N` in the **configuration file**.

Default values

You can set default values for the connection-related parameters (URI, username, password, etc.) in the configuration file in the format:

```
Plugins.<PluginName>.Default.<Parameter>=<Value>
```

For example, `Plugins.Mysql.Default.Username=zabbix`, `Plugins.MongoDB.Default.Uri=tcp://127.0.0.1:27017`, etc.

If a value for such parameter is not provided in an item key or in the **named session** parameters, the plugin will use the default value. If a default parameter is also undefined, hardcoded defaults will be used.

Note:

If an item key does not have any parameters, Zabbix agent 2 will attempt to collect the metric using values defined in the default parameters section.

Named sessions

Named sessions represent an additional level of plugin parameters and can be used to specify separate sets of authentication parameters for each of the instances being monitored. Each named session parameter should have the following structure:

```
Plugins.<PluginName>.Sessions.<SessionName>.<Parameter>=<Value>
```

A session name can be used as a connString item key parameter instead of specifying a URI, username, and/or password separately.

In item keys, the first parameter can be either a connString or a URI. If the first key parameter doesn't match any session name, it will be treated as a URI. Note that passing embedded URI credentials in the item key is not supported, use named session parameters instead.

The list of available **named session parameters** depends on the plugin.

It is possible to override session parameters by specifying new values in the item key parameters (see **example**).

If a parameter is not defined for the named session, Zabbix agent 2 will use the value defined in the **default plugin parameter**.

Parameter priority

Zabbix agent 2 plugins search for connection-related parameter values in the following order:

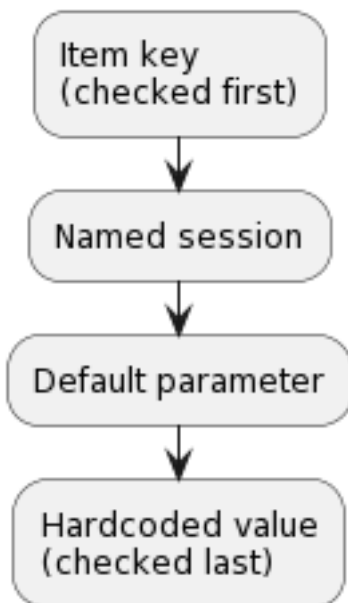

1. The first item key parameter is compared to session names. If no match is found, it is treated as an actual value; in this case, step 3 will be skipped. If a match is found, the parameter value (usually, a URI) must be defined in the named session.
2. Other parameters will be taken from the item key if defined.
3. If an item key parameter (for example, password) is empty, plugin will look for the corresponding named session parameter.
4. If the session parameter is also not specified, the value defined in the corresponding **default parameter** will be used.
5. If all else fails, the plugin will use the hardcoded default value.

Example 1

Monitoring of two instances "MySQL1" and "MySQL2".

Configuration parameters:

```
Plugins.Mysql.Sessions.MySQL1.Uri=tcp://127.0.0.1:3306
Plugins.Mysql.Sessions.MySQL1.User=mysql1_user
Plugins.Mysql.Sessions.MySQL1.Password=unique_password
Plugins.Mysql.Sessions.MySQL2.Uri=tcp://192.0.2.0:3306
Plugins.Mysql.Sessions.MySQL2.User=mysql2_user
Plugins.Mysql.Sessions.MySQL2.Password=different_password
```

As a result of this configuration, each session name may be used as a connString in an **item key**, e.g., `mysql.ping[MySQL1]` or `mysql.ping[MySQL2]`.

Example 2

Providing some of the parameters in the item key.

Configuration parameters:

```
Plugins.PostgreSQL.Sessions.Session1.Uri=tcp://192.0.2.234:5432
Plugins.PostgreSQL.Sessions.Session1.User=old_username
Plugins.PostgreSQL.Sessions.Session1.Password=session_password
```

Item key: `pgsql.ping[session1,new_username,,postgres]`

As a result of this configuration, the agent will connect to PostgreSQL using the following parameters:

- URI from session parameter: `192.0.2.234:5432`
- Username from the item key: `new_username`
- Password from session parameter (since it is omitted in the item key): `session_password`
- Database name from the item key: `postgres`

Example 3

Collecting a metric using default configuration parameters.

Configuration parameters:

```
Plugins.PostgreSQL.Default.Uri=tcp://192.0.2.234:5432
Plugins.PostgreSQL.Default.User=zabbix
Plugins.PostgreSQL.Default.Password=password
```

Item key: `pgsql.ping[,,,postgres]`

As a result of this configuration, the agent will connect to PostgreSQL using the parameters:

- Default URI: `192.0.2.234:5432`
- Default username: `zabbix`
- Default password: `password`
- Database name from the item key: `postgres`

Connections

Some plugins support gathering metrics from multiple instances simultaneously. Both local and remote instances can be monitored. TCP and Unix-socket connections are supported.

It is recommended to configure plugins to keep connections to instances in an open state. The benefits are reduced network congestion, latency, and CPU and memory usage due to the lower number of connections. The client library takes care of this.

Note:

Time period for which unused connections should remain open can be determined by `Plugins.<PluginName>.KeepAlive` parameter. Example: `Plugins.Memcached.KeepAlive`

Plugins

All metrics supported by Zabbix agent 2 are collected by plugins.

Built-in

The following plugins for Zabbix agent 2 are available out-of-the-box. Click on the plugin name to go to the plugin repository with additional information.

Plugin name	Description	Supported item keys	Comments
Agent	Metrics of the Zabbix agent being used.	agent.hostname, agent.ping, agent.version	Supported keys have the same parameters as Zabbix agent keys .

Plugin name	Description	Supported item keys	Comments
Ceph	Ceph monitoring.	ceph.df.details, ceph.osd.stats, ceph.osd.discovery, ceph.osd.dump, ceph.ping, ceph.pool.discovery, ceph.status	
CPU	System CPU monitoring (number of CPUs/CPU cores, discovered CPUs, utilization percentage).	system.cpu.discovery, system.cpu.num, system.cpu.util	Supported keys have the same parameters as Zabbix agent keys .
Docker	Monitoring of Docker containers.	docker.container_info, docker.container_stats, docker.containers, docker.containers.discovery, docker.data_usage, docker.images, docker.images.discovery, docker.info, docker.ping	See also: Configuration parameters
File	File metrics collection.	vfs.file.cksum, vfs.file.contents, vfs.file.exists, vfs.file.md5sum, vfs.file.regexp, vfs.file.regmatch, vfs.file.size, vfs.file.time	Supported keys have the same parameters as Zabbix agent keys .
Kernel	Kernel monitoring.	kernel.maxfiles, kernel.maxproc	Supported keys have the same parameters as Zabbix agent keys .
Log	Log file monitoring.	log, log.count, logrt, logrt.count	Supported keys have the same parameters as Zabbix agent keys . See also: Plugin configuration parameters (Unix/Windows)
Memcached	Memcached server monitoring.	memcached.ping, memcached.stats	
Modbus	Reads Modbus data.	modbus.get	Supported keys have the same parameters as Zabbix agent keys .
MQTT	Receives published values of MQTT topics.	mqtt.get	To configure encrypted connection to the MQTT broker, specify the TLS parameters in the agent configuration file as named session or default parameters. Currently, TLS parameters cannot be passed as item key parameters.
MySQL	Monitoring of MySQL and its forks.	mysql.custom.query, mysql.db.discovery, mysql.db.size, mysql.get_status_variables, mysql.ping, mysql.replication.discovery, mysql.replication.get_slave_status, mysql.version	To configure encrypted connection to the database, specify the TLS parameters in the agent configuration file as named session or default parameters. Currently, TLS parameters cannot be passed as item key parameters.
Netif	Monitoring of network interfaces.	net.if.collisions, net.if.discovery, net.if.in, net.if.out, net.if.total	Supported keys have the same parameters as Zabbix agent keys .

Plugin name	Description	Supported item keys	Comments
Oracle	Oracle Database monitoring.	oracle.diskgroups.stats, ora-cle.diskgroups.discovery, oracle.archive.info, oracle.archive.discovery, oracle.cdb.info, oracle.custom.query, oracle.datafiles.stats, oracle.db.discovery, oracle.fra.stats, oracle.instance.info, oracle.pdb.info, oracle.pdb.discovery, oracle.pga.stats, oracle.ping, oracle.proc.stats, oracle.redolog.info, oracle.sga.stats, oracle.sessions.stats, oracle.sys.metrics, oracle.sys.params, oracle.ts.stats, oracle.ts.discovery, oracle.user.info, oracle.version	Install the Oracle Instant Client before using the plugin.
Proc	Process CPU utilization percentage.	proc.cpu.util	Supported key has the same parameters as Zabbix agent key .
Redis	Redis server monitoring.	redis.config, redis.info, redis.ping, redis.slowlog.count	
Smart	S.M.A.R.T. monitoring.	smart.attribute.discovery, smart.disk.discovery, smart.disk.get	<p>The minimum required smartctl version is 7.1.</p> <p>Sudo/root access rights to smartctl are required for the user executing Zabbix agent 2. The plugin uses only the following commands:</p> <pre>/usr/sbin/smartctl -a * /usr/sbin/smartctl --scan * /usr/sbin/smartctl -j -V</pre> <p>Supported keys can be used with Zabbix agent 2 only on Linux/Windows, both as a passive and active check.</p> <p>See also: Configuration parameters</p>
SW	Listing of installed packages.	system.sw.packages, system.sw.packages.get	The supported keys have the same parameters as Zabbix agent key .
Swap	Swap space size in bytes/percentage.	system.swap.size	Supported key has the same parameters as Zabbix agent key .
SystemRun	Runs specified command.	system.run	Supported key has the same parameters as Zabbix agent key .
			See also: Plugin configuration parameters (Unix/Windows)
Systemd	Monitoring of systemd services.	systemd.unit.discovery, systemd.unit.get, systemd.unit.info	
TCP	TCP connection availability check.	net.tcp.port	Supported key has the same parameters as Zabbix agent key .

Plugin name	Description	Supported item keys	Comments
UDP	Monitoring of the UDP services availability and performance.	net.udp.service, net.udp.service.perf	Supported keys have the same parameters as Zabbix agent keys .
Uname	Retrieval of information about the system.	system.hostname, system.sw.arch, system.uname	Supported keys have the same parameters as Zabbix agent keys .
Uptime	System uptime metrics collection.	system.uptime	Supported key has the same parameters as Zabbix agent key .
VFSDev	VFS metrics collection.	vfs.dev.discovery, vfs.dev.read, vfs.dev.write	Supported keys have the same parameters as Zabbix agent keys .
WebCertificate	Monitoring of TLS/SSL website certificates.	web.certificate.get	
WebPage	Web page monitoring.	web.page.get, web.page.perf, web.page.regex	Supported keys have the same parameters as Zabbix agent keys .
ZabbixAsync	Asynchronous metrics collection.	net.tcp.listen, net.udp.listen, sensor, system.boottime, system.cpu.intr, system.cpu.load, system.cpu.switches, system.hw.cpu, system.hw.macaddr, system.localtime, system.sw.os, system.swap.in, system.swap.out, vfs.fs.discovery	Supported keys have the same parameters as Zabbix agent keys .
ZabbixStats	Zabbix server/proxy internal metrics or number of delayed items in a queue.	zabbix.stats	Supported keys have the same parameters as Zabbix agent keys .
ZabbixSync	Synchronous metrics collection.	net.dns, net.dns.record, net.tcp.service, net.tcp.service.perf, proc.mem, proc.num, system.hw.chassis, system.hw.devices, system.sw.packages, system.users.num, vfs.dir.count, vfs.dir.size, vfs.fs.get, vfs.fs.inode, vfs.fs.size, vm.memory.size.	Supported keys have the same parameters as Zabbix agent keys .

Loadable

Note:

Loadable plugins, when launched with: `
 -V --version` - print plugin version and license information; `
 -h --help` - print help information.

Click on the plugin name to go to the plugin repository with additional information and installation instructions.

Plugin name	Description	Supported item keys	Comments
Ember+	Monitoring of Ember+.	ember.get	Currently only available to be built from the source (for both Unix and Windows). See also Ember+ plugin configuration parameters .
MongoDB	Monitoring of MongoDB servers and clusters (document-based, distributed database).	mongodb.collection.stats, mon-godb.collections.discovery, mon-godb.collections.usage, mon-godb.connpool.stats, mongodb.db.stats, mon-godb.db.discovery, mon-godb.jumbo_chunks.count, mongodb.oplog.stats, mongodb.ping, mongodb.rs.config, mongodb.rs.status, mon-godb.server.status, mongodb.sh.discovery, mongodb.version	To configure encrypted connections to the database, specify the TLS parameters in the agent configuration file as named session parameters. Currently, TLS parameters cannot be passed as item key parameters. See also MongoDB plugin configuration parameters .
MSSQL	Monitoring of MSSQL database.	mssql.availability.group.get, mssql.custom.query, mssql.db.get, mssql.job.status.get, mssql.last.backup.get, mssql.local.db.get, mssql.mirroring.get, mssql.nonlocal.db.get, mssql.perfcounter.get, mssql.ping, mssql.quorum.get, mssql.quorum.member.get, mssql.replica.get, mssql.version	To configure encrypted connection to the database, specify the TLS parameters in the agent configuration file as named session or default parameters. Currently, TLS parameters cannot be passed as item key parameters. See also MSSQL plugin configuration parameters .

Plugin name	Description	Supported item keys	Comments
NVIDIA GPU	Monitoring of NVIDIA GPU.	nvidia.device.count, nvidia.device.decoder.utilization, nvidia.device.ecc.mode, nvidia.device.encoder.stats.get, nvidia.device.encoder.utilization, nvidia.device.energy.consumption, nvidia.device.errors.memory, nvidia.device.errors.register, nvidia.device.fan.speed.avg, nvidia.device.get, nvidia.device.graphics.frequency, nvidia.device.memory.bar1.get, nvidia.device.memory.fb.get, nvidia.device.memory.frequency, nvidia.device.pci.utilization, nvidia.device.performance.state, nvidia.device.power.limit, nvidia.device.power.usage, nvidia.device.serial, nvidia.device.sm.frequency, nvidia.device.temperature, nvidia.device.utilization, nvidia.device.video.frequency, nvidia.system.driver.version, nvidia.version	See also NVIDIA GPU plugin configuration parameters .
PostgreSQL	Monitoring of PostgreSQL and its forks.	postgresql.autovacuum.count, postgresql.archive, postgresql.bgwriter, postgresql.cache.hit, postgresql.connections, postgresql.custom.query, postgresql.dbstat, postgresql.dbstat.sum, postgresql.db.age, postgresql.db.bloating_tables, postgresql.db.discovery, postgresql.db.size, postgresql.locks, postgresql.oldest.xid, postgresql.ping, postgresql.queries, postgresql.replication.count, postgresql.replication.process, postgresql.replication.process.discovery, postgresql.replication.recovery_role, postgresql.replication.status, postgresql.replication_lag.b, postgresql.replication_lag.sec, postgresql.uptime, postgresql.version, postgresql.wal.stat	To configure encrypted connections to the database, specify the TLS parameters in the agent configuration file as named session or default parameters. Currently, TLS parameters cannot be passed as item key parameters. See also PostgreSQL plugin configuration parameters .

See also:

- [Building loadable plugins](#)
- [Zabbix Cloud Images and Appliances](#) for pre-compiled plugin binaries for Windows

1 Building loadable plugins

Overview

This page provides the steps required to build a loadable plugin binary from the sources.

If the source tarball is downloaded, it is possible to build the plugin offline, i.e. without the internet connection.

The PostgreSQL plugin is used as an example. Other loadable plugins can be built in a similar way.

Steps

1. Download the plugin sources from [Zabbix Cloud Images and Appliances](#). The official download page will be available soon.
2. Transfer the archive to the machine where you are going to build the plugin.

3. Unarchive the tarball, e.g.:

```
tar xvf zabbix-agent2-plugin-postgresql-1.0.0.tar.gz
```

Make sure to replace "zabbix-agent2-plugin-postgresql-1.0.0.tar.gz" with the name of the downloaded archive.

4. Enter the extracted directory:

```
cd <path to directory>
```

5. Run:

```
make
```

6. The plugin executable may be placed anywhere as long as it is loadable by Zabbix agent 2. Specify the path to the plugin binary in the plugin configuration file, e.g. in postgresql.conf for the PostgreSQL plugin:

```
Plugins.PostgreSQL.System.Path=/path/to/executable/zabbix-agent2-plugin-postgresql
```

7. Path to the plugin configuration file must be specified in the Include parameter of the Zabbix agent 2 configuration file:

```
Include=/path/to/plugin/configuration/file/postgresql.conf
```

Makefile targets

Loadable plugins provided by Zabbix have simple makefiles with the following targets:

Target	Description
make	Build plugin.
make clean	Delete all files that are normally created by building the plugin.
make check	Perform self-tests. A real PostgreSQL database is required.
make style	Check Go code style with 'golangci-lint'.
make format	Format Go code with 'go fmt'.
make dist	Create an archive containing the plugin sources and sources of all packages needed to build the plugin and its self-tests.

3 Frontend modules

Overview

It is possible to enhance Zabbix frontend functionality by adding third-party modules or by developing your own modules without the need to change the source code of Zabbix.

Note that the module code will run with the same privileges as Zabbix source code. This means:

- third-party modules can be harmful. You must trust the modules you are installing;
- Errors in a third-party module code may crash the frontend. If this happens, just remove the module code from the frontend. As soon as you reload Zabbix frontend, you'll see a note saying that some modules are absent. Go to [Module administration](#) (in *Administration* → *General* → *Modules*) and click *Scan directory* again to remove non-existent modules from the database.

Installation

Please always read the installation manual for a particular module. It is recommended to install new modules one by one to catch failures easily.

Just before you install a module:

- Make sure you have downloaded the module from a trusted source. Installation of harmful code may lead to consequences, such as data loss
- Different versions of the same module (same ID) can be installed in parallel, but only a single version can be enabled at once

Steps to install a module:

- Unpack your module within its own folder in the `modules` folder of the Zabbix frontend
- Ensure that your module folder contains at least the `manifest.json` file
- Navigate to **Module administration** and click the *Scan directory* button
- New module will appear in the list along with its version, author, description and status
- Enable module by clicking on its status

Troubleshooting:

Problem	Solution
<i>Module did not appear in the list</i>	Make sure that the <code>manifest.json</code> file exists in <code>modules/your-module/</code> folder of the Zabbix frontend. If it does that means the module does not suit the current Zabbix version. If <code>manifest.json</code> file does not exist, you have probably unpacked in the wrong directory.
<i>Frontend crashed</i>	The module code is not compatible with the current Zabbix version or server configuration. Please delete module files and reload the frontend. You'll see a notice that some modules are absent. Go to Module administration and click <i>Scan directory</i> again to remove non-existent modules from the database.
<i>Error message about identical namespace, ID or actions appears</i>	New module tried to register a namespace, ID or actions which are already registered by other enabled modules. Disable the conflicting module (mentioned in error message) prior to enabling the new one.
<i>Technical error messages appear</i>	Report errors to the developer of the module.

Developing modules

For information about developing custom modules, see [Developer center](#).

22 Appendixes

Please use the sidebar to access content in the Appendixes section.

1 Installation and setup

Please use the sidebar to access content in this section.

1 Database creation

Overview

A Zabbix database must be created during the installation of Zabbix server or proxy.

This section provides instructions for creating a Zabbix database. A separate set of instructions is available for each supported database.

Note:

To improve database security by creating database roles/users with minimal privileges, see database creation best practices for each supported database:

- [MySQL/MariaDB](#)
- [PostgreSQL/TimescaleDB](#)

For configuring secure TLS connections, see [Secure connection to the database](#).

UTF-8 is the only encoding supported by Zabbix. It is known to work without any security flaws. Users should be aware that there are known security issues if using some of the other encodings. For switching to UTF-8, see [Repairing Zabbix database character set and collation](#).

Note:

If installing from [Zabbix Git repository](#), you need to run the following command prior to proceeding to the next steps:

 make dbschema

MySQL/MariaDB

Character sets utf8 (aka utf8mb3) and utf8mb4 are supported (with utf8_bin and utf8mb4_bin collation respectively) for Zabbix server/proxy to work properly with MySQL database. It is recommended to use utf8mb4 for new installations.

Deterministic triggers need to be created during the import of schema. On MySQL and MariaDB, this requires GLOBAL log_bin_trust_function_creators = 1 to be set if binary logging is enabled and there is no superuser privileges and log_bin_trust_function_creators = 1 is not set in MySQL configuration file.

If you are installing from Zabbix **packages**, proceed to the [instructions](#) for your platform.

If you are installing Zabbix from sources:

- Create and configure a database and a user.

```
mysql -uroot -p<password>

mysql> create database zabbix character set utf8mb4 collate utf8mb4_bin;
mysql> create user 'zabbix'@'localhost' identified by '<password>';
mysql> grant all privileges on zabbix.* to 'zabbix'@'localhost';
mysql> SET GLOBAL log_bin_trust_function_creators = 1;
mysql> quit;
```

- Import the data into the database and set utf8mb4 character set as default. For a Zabbix proxy database, only schema.sql should be imported (no images.sql nor data.sql).

```
cd database/mysql
mysql -uzabbix -p<password> zabbix < schema.sql
#### stop here if you are creating database for Zabbix proxy
mysql -uzabbix -p<password> zabbix < images.sql
mysql -uzabbix -p<password> --default-character-set=utf8mb4 zabbix < data.sql
```

log_bin_trust_function_creators can be disabled after the schema has been successfully imported:

```
mysql -uroot -p<password>

mysql> SET GLOBAL log_bin_trust_function_creators = 0;
mysql> quit;
```

PostgreSQL

You need to have database user with permissions to create database objects.

If you are installing from Zabbix **packages**, proceed to the [instructions](#) for your platform.

If you are installing Zabbix from sources:

- Create a database user.

The following shell command will create user zabbix. Specify a password when prompted and repeat the password (note, you may first be asked for sudo password):

```
sudo -u postgres createuser --pwprompt zabbix
```

- Create a database.

The following shell command will create the database zabbix (last parameter) with the previously created user as the owner (-O zabbix).

```
sudo -u postgres createdb -O zabbix -E Unicode -T template0 zabbix
```

- Import the initial schema and data (assuming you are in the root directory of Zabbix sources). For a Zabbix proxy database, only schema.sql should be imported (no images.sql nor data.sql).

```
cd database/postgresql
cat schema.sql | sudo -u zabbix psql zabbix
#### stop here if you are creating database for Zabbix proxy
```

```
cat images.sql | sudo -u zabbix psql zabbix
cat data.sql | sudo -u zabbix psql zabbix
```

Attention:

The above commands are provided as an example that will work in most of GNU/Linux installations. You can use different commands depending on how your system/database is configured, for example: `psql -U <username>`
If you have any trouble setting up the database, please consult your Database administrator.

TimescaleDB

Instructions for creating and configuring TimescaleDB are provided in a separate [section](#).

SQLite

Using SQLite is supported for **Zabbix proxy** only!

The database will be automatically created if it does not exist.

Return to the [installation section](#).

2 Repairing Zabbix database character set and collation

MySQL/MariaDB

Historically, MySQL and derivatives used 'utf8' as an alias for utf8mb3 - MySQL's own 3-byte implementation of the standard UTF8, which is 4-byte. Starting from MySQL 8.0.28 and MariaDB 10.6.1, 'utf8mb3' character set is deprecated and at some point its support will be dropped while 'utf8' will become a reference to 'utf8mb4'. Since Zabbix 6.0, 'utf8mb4' is supported. To avoid future problems, it is highly recommended to use 'utf8mb4'. Another advantage of switching to 'utf8mb4' is support of supplementary Unicode characters.

Warning:

As versions before Zabbix 6.0 are not aware of utf8mb4, make sure to first upgrade Zabbix server and DB schema to 6.0.x or later before executing utf8mb4 conversion.

1. Check the database character set and collation.

For example:

```
mysql> SELECT @@character_set_database, @@collation_database;
+-----+-----+
| @@character_set_database | @@collation_database |
+-----+-----+
| latin2                   | latin2_general_ci   |
+-----+-----+
```

Or:

```
mysql> SELECT @@character_set_database, @@collation_database;
+-----+-----+
| @@character_set_database | @@collation_database |
+-----+-----+
| utf8                     | utf8_bin             |
+-----+-----+
```

As we see, the character set here is not 'utf8mb4' and collation is not 'utf8mb4_bin', so we need to fix them.

2. Stop Zabbix.

3. Create a backup copy of the database!

4. Fix the character set and collation on database level:

```
alter database <your DB name> character set utf8mb4 collate utf8mb4_bin;
```

Fixed values:

```
mysql> SELECT @@character_set_database, @@collation_database;
+-----+-----+
| @@character_set_database | @@collation_database |
+-----+-----+
```



```
| utf8mb4          | utf8mb4_bin      |
+-----+-----+
```

5. Load the **script** to fix character set and collation on table and column level:

```
mysql <your DB name> < utf8mb4_convert.sql
```

6. Execute the script:

```
        SET @ZABBIX_DATABASE = '<your DB name>';
If MariaDB → set innodb_strict_mode = OFF;
              CALL zbx_convert_utf8();
If MariaDB → set innodb_strict_mode = ON;
              drop procedure zbx_convert_utf8;
```

Please note that 'utf8mb4' is expected to consume slightly more disk space.

7. If no errors - you may want to create a database backup copy with the fixed database.

8. Start Zabbix.

3 Database upgrade to primary keys

Overview

This section provides instructions for manually upgrading tables in existing installations to primary keys.

Upgrading to primary keys optimizes how data is indexed and accessed, which may speed up queries and save space. It also improves data management and synchronization in clustered setups, helping with scaling and ensuring the system remains reliable even if some servers fail.

Attention:

The instructions provided on this page are designed for advanced users and may need to be adjusted for your specific configuration. Upgrading to primary keys can be time-consuming and resource-intensive. Ensure that enough free disk space is available; depending on your database size and stored data, the process may require up to 2.5 times the space currently used by history tables.

Primary keys are used for all tables in new installations since Zabbix 6.0.

There is no automatic database upgrade to primary keys; however, existing installations may be upgraded manually **after** upgrading Zabbix server to 6.0 or newer.

Attention:

Since Zabbix 7.0, upgrading tables to primary keys also upgrades tables to use double precision data types.

 If you have Zabbix 7.0 (or later), tables already use double precision. However, the instructions on this page can still be followed to upgrade tables to primary keys without affecting tables that already use double precision.

 If you have Zabbix 6.4 (or earlier), consider upgrading tables to double precision first. For more information, see [Upgrading to numeric values of extended range](#) in Zabbix 7.0 documentation.

Instructions are available for:

- [MySQL](#)
- [PostgreSQL](#)
- [TimescaleDB](#)

Important notes

To perform the database upgrade:

1. Stop Zabbix server.

Stopping Zabbix server for the time of the upgrade is strongly recommended. However, if absolutely necessary, you can perform the upgrade while the server is running (only for MySQL, MariaDB, and PostgreSQL without TimescaleDB).

2. Back up your database.
3. Run the scripts for your database.
4. Start Zabbix server.

Warning:

Run the scripts for the server database only. The proxy will not benefit from this upgrade.

If the database uses partitions, contact the DB administrator or Zabbix Support for help.

CSV files can be removed after a successful upgrade to primary keys.

Optionally, Zabbix frontend may be switched to **maintenance mode**.

MySQL

Export and import must be performed in tmux/screen to ensure that the session isn't dropped.

See also: **Important notes**

MySQL 8.0+ with mysqlsh

This method can be used with a running Zabbix server, but it is recommended to stop the server for the time of the upgrade. The MySQL Shell (*mysqlsh*) must be **installed** and able to connect to the DB.

- Log in to MySQL console as root (recommended) or as any user with FILE privileges.
- Start MySQL with **local_infile** variable enabled.
- Rename old tables and create new tables by running `history_upgrade_prepare.sql`.

```
mysql -uzabbix -p<password> zabbix < /usr/share/zabbix-sql-scripts/mysql/option-patches/history_upgrade_prepare.sql
```

- Export and import data.

Connect via `mysqlsh`. If using a socket connection, specifying the path might be required.

```
sudo mysqlsh -uroot -S /run/mysqld/mysqld.sock --no-password -Dzabbix
```

Run (CSVPATH can be changed as needed):

```
CSVPATH="/var/lib/mysql-files";
```

```
util.exportTable("history_old", CSVPATH + "/history.csv", { dialect: "csv" });
util.importTable(CSVPATH + "/history.csv", {"dialect": "csv", "table": "history" });

util.exportTable("history_uint_old", CSVPATH + "/history_uint.csv", { dialect: "csv" });
util.importTable(CSVPATH + "/history_uint.csv", {"dialect": "csv", "table": "history_uint" });

util.exportTable("history_str_old", CSVPATH + "/history_str.csv", { dialect: "csv" });
util.importTable(CSVPATH + "/history_str.csv", {"dialect": "csv", "table": "history_str" });

util.exportTable("history_log_old", CSVPATH + "/history_log.csv", { dialect: "csv" });
util.importTable(CSVPATH + "/history_log.csv", {"dialect": "csv", "table": "history_log" });

util.exportTable("history_text_old", CSVPATH + "/history_text.csv", { dialect: "csv" });
util.importTable(CSVPATH + "/history_text.csv", {"dialect": "csv", "table": "history_text" });
```

- Follow **post-migration instructions** to drop the old tables.

MariaDB/MySQL 8.0+ without mysqlsh

This upgrade method takes more time and should be used only if an upgrade with *mysqlsh* is not possible.

Table upgrade

- Log in to MySQL console as root (recommended) or any user with FILE privileges.
- Start MySQL with **local_infile** variable enabled.
- Rename old tables and create new tables by running `history_upgrade_prepare.sql`:

```
mysql -uzabbix -p<password> zabbix < /usr/share/zabbix-sql-scripts/mysql/option-patches/history_upgrade_prepare.sql
```

Migration with stopped server

`max_execution_time` must be disabled before migrating data to avoid timeout during migration.

```
SET @@max_execution_time=0;

INSERT IGNORE INTO history SELECT * FROM history_old;
INSERT IGNORE INTO history_uint SELECT * FROM history_uint_old;
INSERT IGNORE INTO history_str SELECT * FROM history_str_old;
INSERT IGNORE INTO history_log SELECT * FROM history_log_old;
INSERT IGNORE INTO history_text SELECT * FROM history_text_old;
```

Follow [post-migration instructions](#) to drop the old tables.

Migration with running server

Check for which paths import/export is enabled:

```
mysql> SELECT @@secure_file_priv;
+-----+
| @@secure_file_priv |
+-----+
| /var/lib/mysql-files/ |
+-----+
```

If *secure_file_priv* value is a path to a directory, export/import will be performed for files in that directory. In this case, edit paths to files in queries accordingly or set the *secure_file_priv* value to an empty string for the upgrade time.

If *secure_file_priv* value is empty, export/import can be performed from any location.

If *secure_file_priv* value is NULL, set it to the path that contains exported table data ('/var/lib/mysql-files/' in the example above).

For more information, see [MySQL documentation](#).

max_execution_time must be disabled before exporting data to avoid timeout during export.

```
SET @@max_execution_time=0;

SELECT * INTO OUTFILE '/var/lib/mysql-files/history.csv' FIELDS TERMINATED BY ',' ESCAPED BY '"' LINES TERMINATED BY '\n'
LOAD DATA INFILE '/var/lib/mysql-files/history.csv' IGNORE INTO TABLE history FIELDS TERMINATED BY ',' ESCAPED BY '"' LINES TERMINATED BY '\n';

SELECT * INTO OUTFILE '/var/lib/mysql-files/history_uint.csv' FIELDS TERMINATED BY ',' ESCAPED BY '"' LINES TERMINATED BY '\n'
LOAD DATA INFILE '/var/lib/mysql-files/history_uint.csv' IGNORE INTO TABLE history_uint FIELDS TERMINATED BY ',' ESCAPED BY '"' LINES TERMINATED BY '\n';

SELECT * INTO OUTFILE '/var/lib/mysql-files/history_str.csv' FIELDS TERMINATED BY ',' ESCAPED BY '"' LINES TERMINATED BY '\n'
LOAD DATA INFILE '/var/lib/mysql-files/history_str.csv' IGNORE INTO TABLE history_str FIELDS TERMINATED BY ',' ESCAPED BY '"' LINES TERMINATED BY '\n';

SELECT * INTO OUTFILE '/var/lib/mysql-files/history_log.csv' FIELDS TERMINATED BY ',' ESCAPED BY '"' LINES TERMINATED BY '\n'
LOAD DATA INFILE '/var/lib/mysql-files/history_log.csv' IGNORE INTO TABLE history_log FIELDS TERMINATED BY ',' ESCAPED BY '"' LINES TERMINATED BY '\n';

SELECT * INTO OUTFILE '/var/lib/mysql-files/history_text.csv' FIELDS TERMINATED BY ',' ESCAPED BY '"' LINES TERMINATED BY '\n'
LOAD DATA INFILE '/var/lib/mysql-files/history_text.csv' IGNORE INTO TABLE history_text FIELDS TERMINATED BY ',' ESCAPED BY '"' LINES TERMINATED BY '\n';
```

Follow [post-migration instructions](#) to drop the old tables.

PostgreSQL

Export and import must be performed in tmux/screen to ensure that the session isn't dropped. For installations with TimescaleDB, skip this section and proceed to [PostgreSQL + TimescaleDB](#).

See also: [Important notes](#)

Table upgrade

- Rename tables using `history_upgrade_prepare.sql`:

```
sudo -u zabbix psql zabbix < /usr/share/zabbix-sql-scripts/postgresql/option-patches/history_upgrade_prepare.sql
```

Migration with stopped server

- Export current history, import it to the temp table, then insert the data into new tables while ignoring duplicates:

```
INSERT INTO history SELECT * FROM history_old ON CONFLICT (itemid,clock,ns) DO NOTHING;

INSERT INTO history_uint SELECT * FROM history_uint_old ON CONFLICT (itemid,clock,ns) DO NOTHING;
```

```

INSERT INTO history_str SELECT * FROM history_str_old ON CONFLICT (itemid,clock,ns) DO NOTHING;
INSERT INTO history_log SELECT * FROM history_log_old ON CONFLICT (itemid,clock,ns) DO NOTHING;
INSERT INTO history_text SELECT * FROM history_text_old ON CONFLICT (itemid,clock,ns) DO NOTHING;

```

See tips for improving INSERT performance: [PostgreSQL: Bulk Loading Huge Amounts of Data, Checkpoint Distance and Amount of WAL](#).

- Follow [post-migration instructions](#) to drop the old tables.

Migration with running server

- Export current history, import it to the temp table, then insert the data into new tables while ignoring duplicates:

```

\copy history_old TO '/tmp/history.csv' DELIMITER ',' CSV
CREATE TEMP TABLE temp_history (
    itemid          bigint          NOT NULL,
    clock           integer         DEFAULT '0'    NOT NULL,
    value           DOUBLE PRECISION DEFAULT '0.0000' NOT NULL,
    ns              integer         DEFAULT '0'    NOT NULL
);
\copy temp_history FROM '/tmp/history.csv' DELIMITER ',' CSV
INSERT INTO history SELECT * FROM temp_history ON CONFLICT (itemid,clock,ns) DO NOTHING;

\copy history_uint_old TO '/tmp/history_uint.csv' DELIMITER ',' CSV
CREATE TEMP TABLE temp_history_uint (
    itemid          bigint          NOT NULL,
    clock           integer         DEFAULT '0'    NOT NULL,
    value           numeric(20)     DEFAULT '0'    NOT NULL,
    ns              integer         DEFAULT '0'    NOT NULL
);
\copy temp_history_uint FROM '/tmp/history_uint.csv' DELIMITER ',' CSV
INSERT INTO history_uint SELECT * FROM temp_history_uint ON CONFLICT (itemid,clock,ns) DO NOTHING;

\copy history_str_old TO '/tmp/history_str.csv' DELIMITER ',' CSV
CREATE TEMP TABLE temp_history_str (
    itemid          bigint          NOT NULL,
    clock           integer         DEFAULT '0'    NOT NULL,
    value           varchar(255)    DEFAULT ''     NOT NULL,
    ns              integer         DEFAULT '0'    NOT NULL
);
\copy temp_history_str FROM '/tmp/history_str.csv' DELIMITER ',' CSV
INSERT INTO history_str (itemid,clock,value,ns) SELECT * FROM temp_history_str ON CONFLICT (itemid,clock,ns) DO NOTHING;

\copy history_log_old TO '/tmp/history_log.csv' DELIMITER ',' CSV
CREATE TEMP TABLE temp_history_log (
    itemid          bigint          NOT NULL,
    clock           integer         DEFAULT '0'    NOT NULL,
    timestamp       integer         DEFAULT '0'    NOT NULL,
    source          varchar(64)     DEFAULT ''     NOT NULL,
    severity        integer         DEFAULT '0'    NOT NULL,
    value           text            DEFAULT ''     NOT NULL,
    logeventid     integer         DEFAULT '0'    NOT NULL,
    ns              integer         DEFAULT '0'    NOT NULL
);
\copy temp_history_log FROM '/tmp/history_log.csv' DELIMITER ',' CSV
INSERT INTO history_log SELECT * FROM temp_history_log ON CONFLICT (itemid,clock,ns) DO NOTHING;

\copy history_text_old TO '/tmp/history_text.csv' DELIMITER ',' CSV
CREATE TEMP TABLE temp_history_text (
    itemid          bigint          NOT NULL,
    clock           integer         DEFAULT '0'    NOT NULL,
    value           text            DEFAULT ''     NOT NULL,
    ns              integer         DEFAULT '0'    NOT NULL

```

```
);
\copy temp_history_text FROM '/tmp/history_text.csv' DELIMITER ',' CSV
INSERT INTO history_text SELECT * FROM temp_history_text ON CONFLICT (itemid, clock, ns) DO NOTHING;
```

- Follow [post-migration instructions](#) to drop the old tables.

PostgreSQL + TimescaleDB

Export and import must be performed in tmux/screen to ensure that the session isn't dropped. Zabbix server should be down during the upgrade.

See also: [Important notes](#)

- Rename tables using `history_upgrade_prepare.sql`.
 - If compression is enabled (on default installation), run the script from `/usr/share/zabbix-sql-scripts/postgresql/timescaledb/option-patches/with-compression/history_upgrade_prepare.sql`

```
cat /usr/share/zabbix-sql-scripts/postgresql/timescaledb/option-patches/with-compression/history_upgrade_prepare.sql
```
 - If compression is disabled, run the script from `/usr/share/zabbix-sql-scripts/postgresql/timescaledb/option-patches/without-compression/history_upgrade_prepare.sql`

```
cat /usr/share/zabbix-sql-scripts/postgresql/timescaledb/option-patches/without-compression/history_upgrade_prepare.sql
```
- Run TimescaleDB hypertable migration scripts based on compression settings:
 - If compression is enabled (on default installation), run scripts from `/usr/share/zabbix-sql-scripts/postgresql/timescaledb/option-patches/with-compression/`

```
cat /usr/share/zabbix-sql-scripts/postgresql/timescaledb/option-patches/with-compression/history_upgrade_prepare.sql
cat /usr/share/zabbix-sql-scripts/postgresql/timescaledb/option-patches/with-compression/history_upgrade_prepare.sql
cat /usr/share/zabbix-sql-scripts/postgresql/timescaledb/option-patches/with-compression/history_upgrade_prepare.sql
cat /usr/share/zabbix-sql-scripts/postgresql/timescaledb/option-patches/with-compression/history_upgrade_prepare.sql
cat /usr/share/zabbix-sql-scripts/postgresql/timescaledb/option-patches/with-compression/history_upgrade_prepare.sql
cat /usr/share/zabbix-sql-scripts/postgresql/timescaledb/option-patches/with-compression/history_upgrade_prepare.sql
cat /usr/share/zabbix-sql-scripts/postgresql/timescaledb/option-patches/with-compression/trends_upgrade_prepare.sql
```
 - If compression is disabled, run scripts from `/usr/share/zabbix-sql-scripts/postgresql/timescaledb/option-patches/without-compression/`

```
cat /usr/share/zabbix-sql-scripts/postgresql/timescaledb/option-patches/without-compression/history_upgrade_prepare.sql
cat /usr/share/zabbix-sql-scripts/postgresql/timescaledb/option-patches/without-compression/history_upgrade_prepare.sql
cat /usr/share/zabbix-sql-scripts/postgresql/timescaledb/option-patches/without-compression/history_upgrade_prepare.sql
cat /usr/share/zabbix-sql-scripts/postgresql/timescaledb/option-patches/without-compression/history_upgrade_prepare.sql
cat /usr/share/zabbix-sql-scripts/postgresql/timescaledb/option-patches/without-compression/history_upgrade_prepare.sql
cat /usr/share/zabbix-sql-scripts/postgresql/timescaledb/option-patches/without-compression/history_upgrade_prepare.sql
cat /usr/share/zabbix-sql-scripts/postgresql/timescaledb/option-patches/without-compression/trends_upgrade_prepare.sql
```

See also: [Tips](#) for improving INSERT performance.

- Follow [post-migration instructions](#) to drop the old tables.

Post-migration

For all databases, once the migration is completed, do the following:

- Verify that everything works as expected.
- Drop old tables:

```
DROP TABLE history_old;
DROP TABLE history_uint_old;
DROP TABLE history_str_old;
DROP TABLE history_log_old;
DROP TABLE history_text_old;
```

- For TimescaleDB, also drop the following old table:

```
DROP TABLE trends_old;
```

See also

- [Preparing auditlog table for partitioning](#)

4 Preparing auditlog table for partitioning

Overview

Some databases (for example, MySQL) require the partitioning column to be part of the table's unique constraint. Therefore, to partition the auditlog table by time, the primary key must be changed from `auditid` to a composite key `auditid + clock`.

This section provides instructions for altering the primary key of the auditlog table.

Attention:

The instructions provided on this page are designed for advanced users. Note that these instructions might need to be adjusted for your specific configuration. Altering the primary key can also be incompatible with future upgrade patches, so manually handling future upgrades may be necessary. Altering the primary key can be a resource-intensive operation that takes a lot of time depending on the auditlog table size. Stopping Zabbix server and switching Zabbix frontend to **maintenance mode** for the time of the alteration is recommended. However, if absolutely necessary, there is a way to alter the primary key without downtime (see below).

Partitioning the auditlog table can improve, for example, housekeeping in large setups. Although Zabbix **housekeeping** currently cannot take advantage of partitioned tables (except for TimescaleDB), you can disable Zabbix housekeeping and delete partitions using scripts.

Since Zabbix 7.0, the auditlog table for TimescaleDB has been converted to a hypertable, which allows the housekeeper to drop data by chunks. To upgrade the existing auditlog table to a hypertable, see [Upgrading TimescaleDB schema](#).

MySQL

Important notes on rebuilding indexes

MySQL automatically rebuilds indexes for the primary key during the ALTER TABLE operation. However, it is highly recommended to also manually rebuild indexes with the OPTIMIZE TABLE statement to ensure optimal database performance.

Rebuilding indexes may temporarily require as much additional disk space as the table itself uses. To obtain the current size of data and indexes, you can execute the following statements:

```
ANALYZE TABLE auditlog;
SHOW TABLE STATUS LIKE 'auditlog';
```

If the available disk space is a concern, follow the [Altering primary key without downtime](#) instructions. Other options are also available:

- Increasing the `sort_buffer_size` MySQL parameter may help to reduce disk space usage when manually rebuilding indexes. However, modifying this variable may impact overall memory usage of the database.
- Consider freeing up space by deleting potentially unnecessary data.
- Consider decreasing the `Data storage period housekeeper` parameter before executing the housekeeper.

Altering primary key with downtime

1. Drop the current auditlog table primary key and add the new primary key.

```
ALTER TABLE auditlog DROP PRIMARY KEY, ADD PRIMARY KEY (auditid, clock);
```

2. Rebuild indexes (optional but highly recommended, see [Important notes on rebuilding indexes](#)).

```
OPTIMIZE TABLE auditlog;
```

Altering primary key without downtime

Manual method of altering the primary key is described here. Alternatively, you can use the [pt-online-schema-change](#) toolkit from Percona. This toolkit performs the following actions automatically, while also minimizing the space used for altering the auditlog table.

1. Create a new table with the new primary key and create indexes.

```
CREATE TABLE `auditlog_new` (
  `auditid`          varchar(25)          NOT NULL,
  `userid`           bigint unsigned     NULL,
  `username`         varchar(100)        DEFAULT ''      NOT NULL,
  `clock`            integer             DEFAULT '0'     NOT NULL,
  `ip`               varchar(39)         DEFAULT ''      NOT NULL,
  `action`           integer             DEFAULT '0'     NOT NULL,
  `resourcetype`     integer             DEFAULT '0'     NOT NULL,
  `resourceid`       bigint unsigned     NULL,
  `resource_cuid`    varchar(25)         NULL,
  `resource_name`    varchar(255)        DEFAULT ''      NOT NULL,
  `recordsetid`     varchar(25)         NOT NULL,
  `details`          longtext           NOT NULL,
  PRIMARY KEY (auditid,clock)
```

```

) ENGINE=InnoDB;
CREATE INDEX `auditlog_1` ON `auditlog_new` (`userid`,`clock`);
CREATE INDEX `auditlog_2` ON `auditlog_new` (`clock`);
CREATE INDEX `auditlog_3` ON `auditlog_new` (`resourcetype`,`resourceid`);

```

2. Swap tables.

```
RENAME TABLE auditlog TO auditlog_old, auditlog_new TO auditlog;
```

3. Copy data from the old table to the new table.

```
INSERT INTO auditlog SELECT * FROM auditlog_old;
```

This can be done in chunks (multiple INSERT INTO statements with WHERE clock clauses as needed) to avoid excessive resource usage.

4. Drop the old table.

```
DROP TABLE auditlog_old;
```

PostgreSQL

Important notes on rebuilding indexes

PostgreSQL automatically rebuilds indexes for the primary key during the ALTER TABLE operation. However, it is highly recommended to also manually rebuild indexes with the REINDEX TABLE CONCURRENTLY statement to ensure optimal database performance.

Rebuilding indexes may temporarily require up to three times of disk space currently used by indexes. To obtain the current size of indexes, you can execute the following query:

```
SELECT pg_size_pretty(pg_indexes_size('auditlog'));
```

If the available disk space is a concern, follow the [Altering primary key without downtime](#) instructions. Other options are also available:

- Increasing the [maintenance_work_mem](#) PostgreSQL parameter may help to reduce disk space usage when manually rebuilding indexes. However, modifying this variable may impact overall memory usage of the database.
- If you have another disk or tablespace with more available space, you might consider changing the temporary storage location for the index rebuild. You can set the [temp_tablespaces](#) PostgreSQL parameter to specify a different tablespace for temporary objects.
- Consider freeing up space by deleting potentially unnecessary data.
- Consider decreasing the *Data storage period* [housekeeper](#) parameter before executing the housekeeper.

Altering primary key with downtime

1. Drop the current auditlog table primary key and add the new primary key.

```
ALTER TABLE auditlog DROP CONSTRAINT auditlog_pkey;
ALTER TABLE auditlog ADD PRIMARY KEY (auditid,clock);
```

2. Rebuild indexes (optional but highly recommended, see [Important notes on rebuilding indexes](#)).

```
REINDEX TABLE CONCURRENTLY auditlog;
```

Altering primary key without downtime

Manual method of altering the primary key is described here. Alternatively, the `pg_repack` extension can be considered for creating a new table, copying data, and swapping tables.

1. Create a new table with the new primary key and create indexes.

```

CREATE TABLE auditlog_new (
  auditid          varchar(25)          NOT NULL,
  userid           bigint              NULL,
  username         varchar(100)        DEFAULT '' NOT NULL,
  clock            integer             DEFAULT '0' NOT NULL,
  ip               varchar(39)         DEFAULT '' NOT NULL,
  action           integer             DEFAULT '0' NOT NULL,
  resourcetype     integer             DEFAULT '0' NOT NULL,
  resourceid       bigint              NULL,
  resource_cuid    varchar(25)         NULL,

```

```

resource_name      varchar(255)      DEFAULT ''          NOT NULL,
recordsetid        varchar(25)       NOT NULL,
details            text             DEFAULT ''          NOT NULL,
PRIMARY KEY (auditid,clock)
);
CREATE INDEX auditlog_new_1 ON auditlog_new (userid,clock);
CREATE INDEX auditlog_new_2 ON auditlog_new (clock);
CREATE INDEX auditlog_new_3 ON auditlog_new (resourcetype,resourceid);

```

2. Swap tables.

```

ALTER TABLE auditlog RENAME TO auditlog_old;
ALTER TABLE auditlog_new RENAME TO auditlog;

```

3. Copy data from the old table to the new table.

```

INSERT INTO auditlog SELECT * FROM auditlog_old;

```

This can be done in chunks (multiple INSERT INTO statements with WHERE clock clauses as needed) to avoid excessive resource usage.

4. Drop the old table.

```

DROP TABLE auditlog_old;

```

See also

- [Database upgrade to primary keys](#)

5 Secure connection to the database

Overview

This section provides Zabbix setup steps and configuration examples for secure TLS connections between:

Database	Zabbix components
MySQL	Zabbix frontend, Zabbix server, Zabbix proxy
PostgreSQL	Zabbix frontend, Zabbix server, Zabbix proxy

To set up connection encryption within the DBMS, see official vendor documentation for details:

- [MySQL](#): source and replica replication database servers.
- [MySQL](#): group replication, etc. database servers.
- [PostgreSQL](#) encryption options.

All examples are based on the GA releases of MySQL CE (8.0) and PostgreSQL (13) available through official repositories using CentOS 8.

Requirements

The following is required to set up encryption:

- Developer-supported operating system with OpenSSL >=1.1.X or alternative.

Note:

It is recommended to avoid OS in the end-of-life status, especially in the case of new installations

- Database engine (RDBMS) installed and maintained from the official repository provided by developer. Operating systems often shipped with outdated database software versions for which encryption support is not implemented, for example RHEL 7 based systems and PostgreSQL 9.2, MariaDB 5.5 without encryption support.

Terminology

Setting this option enforces to use TLS connection to database from Zabbix server/proxy and frontend to database:

- `required` - connect using TLS as transport mode without identity checks;
- `verify_ca` - connect using TLS and verify certificate;

- `verify_full` - connect using TLS, verify certificate and verify that database identity (CN) specified by `DBHost` matches its certificate;

Zabbix configuration

Frontend to the database

A secure connection to the database can be configured during frontend installation:

- Mark the *Database TLS encryption* checkbox in the **Configure DB connection** step to enable transport encryption.
- Mark the *Verify database certificate* checkbox that appears when *TLS encryption* field is checked to enable encryption with certificates.

Note:

For MySQL, the *Database TLS encryption* checkbox is disabled, if *Database host* is set to `localhost`, because connection that uses a socket file (on Unix) or shared memory (on Windows) cannot be encrypted.

For PostgreSQL, the *TLS encryption* checkbox is disabled, if the value of the *Database host* field begins with a slash or the field is empty.

The following parameters become available in the TLS encryption in certificates mode (if both checkboxes are marked):

Parameter	Description
<i>Database TLS CA file</i>	Specify the full path to a valid TLS certificate authority (CA) file.
<i>Database TLS key file</i>	Specify the full path to a valid TLS key file.
<i>Database TLS certificate file</i>	Specify the full path to a valid TLS certificate file.
<i>Database host verification</i>	Mark this checkbox to activate host verification. Disabled for MySQL, because PHP MySQL library does not allow to skip the peer certificate validation step.
<i>Database TLS cipher list</i>	Specify a custom list of valid ciphers. The format of the cipher list must conform to the OpenSSL standard. Available for MySQL only.

Attention:

TLS parameters must point to valid files. If they point to non-existent or invalid files, it will lead to the authorization error. If certificate files are writable, the frontend generates a warning in the **System information** report that "TLS certificate files must be read-only." (displayed only if the PHP user is the owner of the certificate).

Certificates protected by passwords are not supported.

Use cases

Zabbix frontend uses GUI interface to define possible options: `required`, `verify_ca`, `verify_full`. Specify required options in the installation wizard step *Configure DB connections*. These options are mapped to the configuration file (`zabbix.conf.php`) in the following manner:

GUI settings	Configuration file	Description	Result
	<pre>... // Used for TLS connection. \$DB['ENCRYPTION'] = true; \$DB['KEY_FILE'] = ""; \$DB['CERT_FILE'] = ""; \$DB['CA_FILE'] = ""; \$DB['VERIFY_HOST'] = false; \$DB['CIPHER_LIST'] = ""; ...</pre>	<p>Check <i>Database TLS encryption</i></p> <p>Leave <i>Verify database certificate</i> unchecked</p>	<p>Enable 'required' mode.</p>

GUI settings	Configuration file	Description	Result
--------------	--------------------	-------------	--------

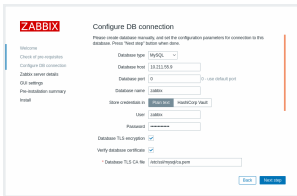

```
...
$DB['ENCRYPTION'] =
true;\ $DB['KEY_FILE'] = "";
$DB['CERT_FILE'] = "";
$DB['CA_FILE'] =
'/etc/ssl/mysql/ca.pem';
$DB['VERIFY_HOST'] =
false;
$DB['CIPHER_LIST'] = "";
...
```

1. Check *Database TLS encryption* and *Verify database certificate*
2. Specify path to *Database TLS CA file*

Enable 'verify_ca' mode.

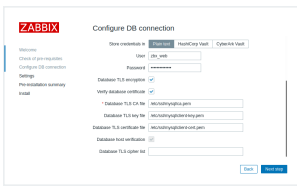

```
...
// Used for TLS connection
with strictly defined Cipher
list.
$DB['ENCRYPTION'] = true;
$DB['KEY_FILE'] =
'<key_file_path>';
$DB['CERT_FILE'] =
'<key_file_path>';
$DB['CA_FILE'] =
'<key_file_path>';
$DB['VERIFY_HOST'] = true;
$DB['CIPHER_LIST'] =
'<cipher_list>';
...
```

1. Check *Database TLS encryption* and *Verify database certificate*
2. Specify path to *Database TLS key file*
3. Specify path to *Database TLS CA file*
4. Specify path to *Database TLS certificate file*
5. Specify TLS cipher list (optional)

Enable 'verify_full' mode for MySQL.

```
Or:

...
// Used for TLS connection
without Cipher list defined -
selected by MySQL server
$DB['ENCRYPTION'] = true;
$DB['KEY_FILE'] =
'<key_file_path>';
$DB['CERT_FILE'] =
'<key_file_path>';
$DB['CA_FILE'] =
'<key_file_path>';
$DB['VERIFY_HOST'] = true;
$DB['CIPHER_LIST'] = "";
...
```

GUI settings	Configuration file	Description	Result
	<pre> ... \$DB['ENCRYPTION'] = true; \$DB['KEY_FILE'] = '<key_file_path>'; \$DB['CERT_FILE'] = '<key_file_path>'; \$DB['CA_FILE'] = '<key_file_path>'; \$DB['VERIFY_HOST'] = true; \$DB['CIPHER_LIST'] = ' '; ... </pre>	<ol style="list-style-type: none"> 1. Check <i>Database TLS encryption</i> and <i>Verify database certificate</i> 2. Specify path to <i>Database TLS key file</i> 3. Specify path to <i>Database TLS CA file</i> 4. Specify path to <i>Database TLS certificate file</i> 5. Check <i>Database host verification</i> 	<p>Enable 'verify_full' mode for PostgreSQL.</p>

See also: [Encryption configuration examples for MySQL](#), [Encryption configuration examples for PostgreSQL](#).

Zabbix server/proxy configuration

Secure connections to the database can be configured with the respective parameters in the Zabbix [server](#) and/or [proxy](#) configuration file.

Configuration	Result
None	Connection to the database without encryption.
1. Set DBTLSConnect=required	Server/proxy make a TLS connection to the database. An unencrypted connection is not allowed.
1. Set DBTLSConnect=verify_ca	Server/proxy make a TLS connection to the database after verifying the database certificate.
2. Set DBTLSCAFile - specify the TLS certificate authority file	Server/proxy make a TLS connection to the database after verifying the database certificate and the database host identity.
1. Set DBTLSConnect=verify_full	Server/proxy provide a client certificate while connecting to the database.
2. Set DBTLSCAFile - specify TLS certificate authority file	
1. Set DBTLSCAFile - specify TLS certificate authority file	
2. Set DBTLSCertFile - specify the client public key certificate file	
3. Set DBTLSKeyFile - specify the client private key file	
1. Set DBTLSCipher - the list of encryption ciphers that the client permits for connections using TLS protocols up to TLS 1.2	(MySQL) TLS connection is made using a cipher from the provided list. (PostgreSQL) Setting this option will be considered as an error.
or DBTLSCipher13 - the list of encryption ciphers that the client permits for connections using TLS 1.3 protocol	

1 MySQL encryption configuration

Overview

This section provides several encryption configuration examples for CentOS 8.2 and MySQL 8.0.21 and can be used as a quickstart guide for encrypting the connection to the database.

Attention:

If MySQL host is set to localhost, encryption options will not be available. In this case a connection between Zabbix frontend and the database uses a socket file (on Unix) or shared memory (on Windows) and cannot be encrypted.

Note:

List of encryption combinations is not limited to the ones listed on this page. There are a lot more combinations available.

Pre-requisites

Install MySQL database from the [official repository](#).

See [MySQL documentation](#) for details on how to use MySQL repo.

MySQL server is ready to accept secure connections using a self-signed certificate.

To see, which users are using an encrypted connection, run the following query (Performance Schema should be turned ON):

```
mysql> SELECT sbt.variable_value AS tls_version, t2.variable_value AS cipher, processlist_user AS user, pr
      FROM performance_schema.status_by_thread AS sbt
      JOIN performance_schema.threads AS t ON t.thread_id = sbt.thread_id
      JOIN performance_schema.status_by_thread AS t2 ON t2.thread_id = t.thread_id
      WHERE sbt.variable_name = 'Ssl_version' and t2.variable_name = 'Ssl_cipher'
      ORDER BY tls_version;
```

Required mode

MySQL configuration

Modern versions of the database are ready out-of-the-box for 'required' **encryption mode**. A server-side certificate will be created after initial setup and launch.

Create users and roles for the main components:

```
mysql> CREATE USER
      'zbx_srv'@%' IDENTIFIED WITH mysql_native_password BY '<strong_password>',
      'zbx_web'@%' IDENTIFIED WITH mysql_native_password BY '<strong_password>'
      REQUIRE SSL
      PASSWORD HISTORY 5;
```

```
mysql> CREATE ROLE 'zbx_srv_role', 'zbx_web_role';
```

```
mysql> GRANT SELECT, UPDATE, DELETE, INSERT, CREATE, DROP, ALTER, INDEX, REFERENCES ON zabbix.* TO 'zbx_srv'@%;
mysql> GRANT SELECT, UPDATE, DELETE, INSERT ON zabbix.* TO 'zbx_web_role';
```

```
mysql> GRANT 'zbx_srv_role' TO 'zbx_srv'@%;
mysql> GRANT 'zbx_web_role' TO 'zbx_web'@%;
```

```
mysql> SET DEFAULT ROLE 'zbx_srv_role' TO 'zbx_srv'@%;
mysql> SET DEFAULT ROLE 'zbx_web_role' TO 'zbx_web'@%;
```

Note that the X.509 protocol is not used to check identity, but the user is configured to use only encrypted connections. See [MySQL documentation](#) for more details about configuring users.

Run to check connection (socket connection cannot be used to test secure connections):

```
mysql -u zbx_srv -p -h 10.211.55.9 --ssl-mode=REQUIRED
```

Check current status and available cipher suites:

```
mysql> status
```

```
-----
mysql Ver 8.0.21 for Linux on x86_64 (MySQL Community Server - GPL)
```

```
Connection id: 62
```

```
Current database:
```

```
Current user: zbx_srv@bdfdb.local
```

```
SSL: Cipher in use is TLS_AES_256_GCM_SHA384
```

```
mysql> SHOW SESSION STATUS LIKE 'Ssl_cipher_list'\G;
```

```
***** 1. row *****
```

```
Variable_name: Ssl_cipher_list
```

```
Value: TLS_AES_256_GCM_SHA384:TLS_CHACHA20_POLY1305_SHA256:TLS_AES_128_GCM_SHA256:TLS_AES_128_CCM_SHA256:...
```

```
1 row in set (0.00 sec)
```

```
ERROR:
```

```
No query specified
```

```
Frontend
```

To enable transport-only encryption for connections between Zabbix frontend and the database:

- Check *Database TLS encryption*
- Leave *Verify database certificate* unchecked

ZABBIX

Configure DB connection

Please create database manually, and set the configuration parameters for connection to this database. Press "Next step" button when done.

Database type:

Database host:

Database port: 0 - use default port

Database name:

Store credentials in: Plain text HashiCorp Vault CyberArk Vault

User:

Password:

Database TLS encryption:

Verify database certificate:

Server

To enable transport-only encryption for connections between server and the database, configure `/etc/zabbix/zabbix_server.conf`:

```
...
DBHost=10.211.55.9
DBName=zabbix
DBUser=zbx_srv
DBPassword=<strong_password>
DBTLSConnect=required
...
```

Verify CA mode

Copy required MySQL CA to the Zabbix frontend server, assign proper permissions to allow the webserver to read this file.

Note:

Verify CA mode doesn't work on RHEL 7 due to older MySQL libraries.

Frontend

To enable encryption with certificate verification for connections between Zabbix frontend and the database:

- Check *Database TLS encryption* and *Verify database certificate*
- Specify path to Database TLS CA file

Alternatively, this can be set in `/etc/zabbix/web/zabbix.conf.php`:

```
...
$DB['ENCRYPTION'] = true;
$DB['KEY_FILE'] = '';
$DB['CERT_FILE'] = '';
$DB['CA_FILE'] = '/etc/ssl/mysql/ca.pem';
$DB['VERIFY_HOST'] = false;
$DB['CIPHER_LIST'] = '';
...
```

Troubleshoot user using command-line tool to check if connection is possible for required user:

```
mysql -u zbx_web -p -h 10.211.55.9 --ssl-mode=REQUIRED --ssl-ca=/var/lib/mysql/ca.pem
```

Server

To enable encryption with certificate verification for connections between Zabbix server and the database, configure `/etc/zabbix/zabbix_server.conf`:

```
...
DBHost=10.211.55.9
DBName=zabbix
DBUser=zbx_srv
DBPassword=<strong_password>
DBTLSConnect=verify_ca
DBTLSCAFile=/etc/ssl/mysql/ca.pem
...
```

Verify Full mode

MySQL configuration

Set MySQL CE server configuration option (`/etc/my.cnf.d/server-tls.cnf`) to:

```
[mysqld]
...
# in this examples keys are located in the MySQL CE datadir directory
ssl_ca=ca.pem
ssl_cert=server-cert.pem
ssl_key=server-key.pem

require_secure_transport=ON
```

```
tls_version=TLSv1.3
```

...

Keys for the MySQL CE server and client (Zabbix frontend) should be created manually according to the MySQL CE documentation: [Creating SSL and RSA certificates and keys using MySQL](#) or [Creating SSL certificates and keys using openssl](#)

Attention:

MySQL server certificate should contain the Common Name field set to the FQDN name as Zabbix frontend will use the DNS name to communicate with the database or IP address of the database host.

Create MySQL user:

```
mysql> CREATE USER
'zbx_srv'@%' IDENTIFIED WITH mysql_native_password BY '<strong_password>',
'zbx_web'@%' IDENTIFIED WITH mysql_native_password BY '<strong_password>'
REQUIRE X509
PASSWORD HISTORY 5;
```

Check if it is possible to log in with that user:

```
mysql -u zbx_web -p -h 10.211.55.9 --ssl-mode=VERIFY_IDENTITY --ssl-ca=/var/lib/mysql/ca.pem --ssl-cert=/v
```

Frontend

To enable encryption with full verification for connections between Zabbix frontend and the database:

- Check Database TLS encryption and Verify database certificate
- Specify path to Database TLS key file
- Specify path to Database TLS CA file
- Specify path to Database TLS certificate file

Note that *Database host verification* is checked and grayed out - this step cannot be skipped for MySQL.

Warning:

Cipher list should be empty, so that frontend and server can negotiate required one from the supported by both ends.

The screenshot shows the Zabbix web interface for configuring the database connection. On the left is a navigation menu with 'Configure DB connection' selected. The main form has a title 'Configure DB connection' and a 'Store credentials in' dropdown set to 'Plain text'. Below this are input fields for 'User' (zbx_web) and 'Password' (masked with dots). There are several checkboxes: 'Database TLS encryption' (checked), 'Verify database certificate' (checked), and 'Database host verification' (checked and disabled). Below these are three text input fields for file paths: 'Database TLS CA file' (/etc/ssl/mysql/ca.pem), 'Database TLS key file' (/etc/ssl/mysql/client-key.pem), and 'Database TLS certificate file' (/etc/ssl/mysql/client-cert.pem). At the bottom is an empty 'Database TLS cipher list' field. 'Back' and 'Next step' buttons are at the bottom right.

Alternatively, this can be set in `/etc/zabbix/web/zabbix.conf.php`:

```
...
// Used for TLS connection with strictly defined Cipher list.
$DB['ENCRYPTION'] = true;
$DB['KEY_FILE'] = '/etc/ssl/mysql/client-key.pem';
$DB['CERT_FILE'] = '/etc/ssl/mysql/client-cert.pem';
$DB['CA_FILE'] = '/etc/ssl/mysql/ca.pem';
```

```

$DB['VERIFY_HOST'] = true;
$DB['CIPHER_LIST'] = 'TLS_AES_256_GCM_SHA384:TLS_CHACHA20_POLY1305_SHA256:TLS_AES_128_GCM_SHA256:TLS_AES_1
...
// or
...
// Used for TLS connection without Cipher list defined - selected by MySQL server
$DB['ENCRYPTION'] = true;
$DB['KEY_FILE'] = '/etc/ssl/mysql/client-key.pem';
$DB['CERT_FILE'] = '/etc/ssl/mysql/client-cert.pem';
$DB['CA_FILE'] = '/etc/ssl/mysql/ca.pem';
$DB['VERIFY_HOST'] = true;
$DB['CIPHER_LIST'] = '';
...

```

Server

To enable encryption with full verification for connections between Zabbix server and the database, configure `/etc/zabbix/zabbix_server.conf`:

```

...
DBHost=10.211.55.9
DBName=zabbix
DBUser=zbx_srv
DBPassword=<strong_password>
DBTLSConnect=verify_full
DBTLSCAFile=/etc/ssl/mysql/ca.pem
DBTLSCertFile=/etc/ssl/mysql/client-cert.pem
DBTLSKeyFile=/etc/ssl/mysql/client-key.pem
...

```

2 PostgreSQL encryption configuration

Overview

This section provides several encryption configuration examples for CentOS 8.2 and PostgreSQL 13.

Note:

Connection between Zabbix frontend and PostgreSQL cannot be encrypted (parameters in GUI are disabled), if the value of *Database host* field begins with a slash or the field is empty.

Pre-requisites

Install the PostgreSQL database using the [official repository](#).

PostgreSQL is not configured to accept TLS connections out-of-the-box. Please follow instructions from PostgreSQL documentation for [certificate preparation with postgresql.conf](#) and also for [user access control](#) through `pg_hba.conf`.

By default, the PostgreSQL socket is binded to the localhost, for the network remote connections allow to listen on the real network interface.

PostgreSQL settings for all `modes` can look like this:

`/var/lib/pgsql/13/data/postgresql.conf`:

```

...
ssl = on
ssl_ca_file = 'root.crt'
ssl_cert_file = 'server.crt'
ssl_key_file = 'server.key'
ssl_ciphers = 'HIGH:MEDIUM:+3DES:!aNULL'
ssl_prefer_server_ciphers = on
ssl_min_protocol_version = 'TLSv1.3'
...

```

For access control adjust `/var/lib/pgsql/13/data/pg_hba.conf`:

```

...
### require
hostssl all all 0.0.0.0/0 md5

```



```
### verify CA
hostssl all all 0.0.0.0/0 md5 clientcert=verify-ca

### verify full
hostssl all all 0.0.0.0/0 md5 clientcert=verify-full
...
```

Required mode

Frontend

To enable transport-only encryption for connections between Zabbix frontend and the database:

- Check *Database TLS encryption*
- Leave *Verify database certificate* unchecked

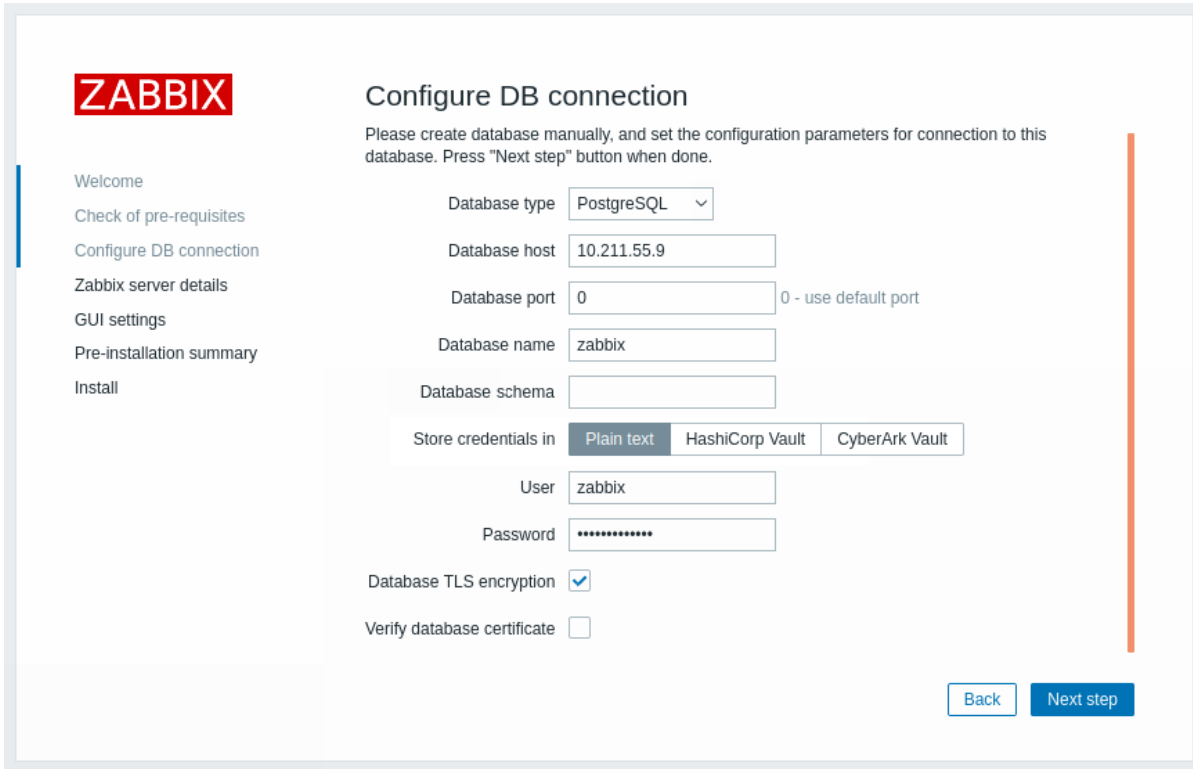

Server

To enable transport-only encryption for connections between server and the database, configure `/etc/zabbix/zabbix_server.conf`:

```
...
DBHost=10.211.55.9
DBName=zabbix
DBUser=zbx_srv
DBPassword=<strong_password>
DBTLSConnect=required
...
```

Verify CA mode

Frontend

To enable encryption with certificate authority verification for connections between Zabbix frontend and the database:

- Check *Database TLS encryption* and *Verify database certificate*
- Specify path to *Database TLS CA file*

Alternatively, this can be set in `/etc/zabbix/web/zabbix.conf.php`:

```
...
$DB['ENCRYPTION'] = true;
$DB['KEY_FILE'] = '';
$DB['CERT_FILE'] = '';
$DB['CA_FILE'] = '/etc/ssl/pgsql/root.crt';
$DB['VERIFY_HOST'] = false;
$DB['CIPHER_LIST'] = '';
...
```

Server

To enable encryption with certificate verification for connections between Zabbix server and the database, configure `/etc/zabbix/zabbix_server.conf`:

```
...
DBHost=10.211.55.9
DBName=zabbix
DBUser=zbx_srv
DBPassword=<strong_password>
DBTLSConnect=verify_ca
DBTLSCAFile=/etc/ssl/pgsql/root.crt
...
```

Verify full mode

Frontend

To enable encryption with certificate and database host identity verification for connections between Zabbix frontend and the database:

- Check *Database TLS encryption* and *Verify database certificate*
- Specify path to *Database TLS key file*
- Specify path to *Database TLS CA file*
- Specify path to *Database TLS certificate file*
- Check *Database host verification*

Alternatively, this can be set in `/etc/zabbix/web/zabbix.conf.php`:

```
$DB['ENCRYPTION'] = true;
$DB['KEY_FILE'] = '';
$DB['CERT_FILE'] = '';
$DB['CA_FILE'] = '/etc/ssl/pgsql/root.crt';
$DB['VERIFY_HOST'] = true;
$DB['CIPHER_LIST'] = '';
...
```

Server

To enable encryption with certificate and database host identity verification for connections between Zabbix server and the database, configure `/etc/zabbix/zabbix_server.conf`:

```
...
DBHost=10.211.55.9
DBName=zabbix
DBUser=zbx_srv
DBPassword=<strong_password>
DBTLSConnect=verify_full
DBTLSCAFile=/etc/ssl/pgsql/root.crt
DBTLSCertFile=/etc/ssl/pgsql/client.crt
DBTLSKeyFile=/etc/ssl/pgsql/client.key
...
```

6 TimescaleDB setup

Overview

Zabbix supports TimescaleDB, a PostgreSQL-based database solution of automatically partitioning data into time-based chunks to support faster performance at scale.

Warning: Currently, TimescaleDB is not supported by Zabbix proxy.

Instructions on this page can be used for the following scenarios:

- Creating a TimescaleDB database or migrating from existing PostgreSQL tables to TimescaleDB (see [Configuration](#)).
- Upgrading an existing TimescaleDB database schema when upgrading Zabbix (see [Upgrading TimescaleDB schema](#)).

Configuration

We assume that TimescaleDB extension has been already installed on the database server (see installation instructions in [Timescale documentation](#)).

TimescaleDB extension must also be enabled for the specific DB by executing:

```
echo "CREATE EXTENSION IF NOT EXISTS timescaledb CASCADE;" | sudo -u postgres psql zabbix
```

Running this command requires database administrator privileges.

Note:

If you use a database schema other than 'public' you need to add a SCHEMA clause to the command above. E.g.:

```
echo "CREATE EXTENSION IF NOT EXISTS timescaledb SCHEMA yourschema CASCADE;" | sudo -u postgres psql zabbix
```

Then run the `postgresql/timescaledb/schema.sql` script. For new installations, the script must be run after the regular PostgreSQL database has been created with initial schema/data (see [database creation](#)).

```
cat /usr/share/zabbix-sql-scripts/postgresql/timescaledb/schema.sql | sudo -u zabbix psql zabbix
```

Attention:

Please ignore warning messages informing that the best practices are not followed while running `schema.sql` script on TimescaleDB version 2.9.0 and higher. Regardless of this warning, the configuration will be completed successfully.

The migration of existing history, trends and audit log data may take a lot of time. Zabbix server and frontend must be down for the period of migration.

The `schema.sql` script sets the following housekeeping parameters:

- Override item history period
- Override item trend period

In order to use partitioned housekeeping for history and trends, both these options must be enabled. It is also possible to enable override individually either for history only or trends only.

For PostgreSQL and TimescaleDB, the `postgresql/timescaledb/schema.sql` script sets two additional parameters:

- Enable compression
- Compress records older than 7 days

To successfully remove compressed data by housekeeper, both *Override item history period* and *Override item trend period* options must be enabled. If override is disabled and tables have compressed chunks, the housekeeper will not remove data from these tables, and warnings about incorrect configuration will be displayed in the *Housekeeping* and *System information* sections.

All of these parameters can be changed in *Administration* → *Housekeeping* after the installation.

Note:

You may want to run the `timescaledb-tune` tool provided by TimescaleDB to optimize PostgreSQL configuration parameters in your `postgresql.conf`.

Upgrading TimescaleDB schema

When upgrading Zabbix to a version that contains new TimescaleDB hypertables, Zabbix server does not automatically configure those hypertables (for example, when upgrading from Zabbix 6.4 to 7.4, as versions 7.0.0 and 7.0.2 have introduced new hypertables).

To configure new TimescaleDB hypertables, follow these steps:

1. Start Zabbix server; this upgrades the existing database.
2. Check the server log file that the database upgrade is completed; when completed, stop Zabbix server. Note that the server logs a warning if it attempts to enable compression for a table that is not a hypertable.
3. Run the `postgresql/timescaledb/schema.sql` script; this configures the new TimescaleDB hypertables. Note that, since Zabbix 7.0.0, the script's location and name have changed from `postgresql/timescaledb.sql` to `postgresql/timescaledb/schema.sql`.

Attention:

Please ignore warning messages informing that the best practices are not followed while running `schema.sql` script on TimescaleDB version 2.9.0 and higher. Regardless of this warning, the configuration will be completed successfully.

TimescaleDB compression

Native TimescaleDB compression is supported for all Zabbix tables that are TimescaleDB hypertables. During the upgrade or migration to TimescaleDB, initial compression of the large tables may take a lot of time.

Note that compression is supported under the "timescale" Timescale Community license and it is not supported under "apache" Apache 2.0 license. If Zabbix detects that compression is not supported a warning message is written into the Zabbix server log and users cannot enable compression in the frontend.

Note:

Users are encouraged to get familiar with compression in [Timescale documentation](#) before using compression.

Note that there are certain limitations imposed by compression, specifically:

- Compressed chunk modifications (inserts, deletes, updates) are not allowed
- Schema changes for compressed tables are not allowed.

Compression settings can be changed in the *History and trends compression* block in *Administration* → *Housekeeping* section of Zabbix frontend.

Parameter	Default	Comments
<i>Enable compression</i>	Enabled	Checking or unchecking the checkbox does not activate/deactivate compression immediately. Because compression is handled by the Housekeeper, the changes will take effect in up to 2 times <code>HousekeepingFrequency</code> hours (set in <code>zabbix_server.conf</code>) After disabling compression, new chunks that fall into the compression period will not be compressed. However, all previously compressed data will stay compressed. To uncompress previously compressed chunks, follow the instructions in Timescale documentation . When upgrading from older versions of Zabbix with TimescaleDB support, compression will not be enabled by default. This parameter cannot be less than 7 days.
<i>Compress records older than</i>	7d	Due to immutability of compressed chunks all late data (e.g. data delayed by a proxy) that is older than this value will be discarded.

7 Elasticsearch setup

Attention:

Elasticsearch support is experimental!

Zabbix supports the storage of historical data by means of Elasticsearch instead of a database. Users can choose the storage place for historical data between a compatible database and Elasticsearch. The setup procedure described in this section is applicable to Elasticsearch version 7.X. In case an earlier or later version of Elasticsearch is used, some functionality may not work as intended.

Warning:

If all history data is stored in Elasticsearch, trends are **not** calculated nor stored in the database. With no trends calculated and stored, the history storage period may need to be extended.

Configuration

To ensure proper communication between all elements involved make sure server configuration file and frontend configuration file parameters are properly configured.

Zabbix server and frontend

Zabbix server configuration file draft with parameters to be updated:

```
### Option: HistoryStorageURL
# History storage HTTP[S] URL.
#
# Mandatory: no
```

```
# Default:
# HistoryStorageURL=
### Option: HistoryStorageTypes
# Comma separated list of value types to be sent to the history storage.
#
# Mandatory: no
# Default:
# HistoryStorageTypes=uint,dbl,str,log,text
```

Example parameter values to fill the Zabbix server configuration file with:

```
HistoryStorageURL=http://test.elasticsearch.lan:9200
HistoryStorageTypes=str,log,text
```

This configuration forces Zabbix Server to store history values of numeric types in the corresponding database and textual history data in Elasticsearch.

Elasticsearch supports the following item types:

```
uint,dbl,str,log,text
```

Supported item type explanation:

Item value type	Database table	Elasticsearch type
Numeric (unsigned)	history_uint	uint
Numeric (float)	history	dbl
Character	history_str	str
Log	history_log	log
Text	history_text	text

Zabbix frontend configuration file (`conf/zabbix.conf.php`) draft with parameters to be updated:

```
// Elasticsearch url (can be string if same url is used for all types).
$HISTORY['url'] = [
    'uint' => 'http://localhost:9200',
    'text' => 'http://localhost:9200'
];
// Value types stored in Elasticsearch.
$HISTORY['types'] = ['uint', 'text'];
```

Example parameter values to fill the Zabbix frontend configuration file with:

```
$HISTORY['url'] = 'http://test.elasticsearch.lan:9200';
$HISTORY['types'] = ['str', 'text', 'log'];
```

This configuration forces to store Text, Character and Log history values in Elasticsearch.

It is also required to make `$HISTORY` global in `conf/zabbix.conf.php` to ensure everything is working properly (see `conf/zabbix.conf.php.example` for how to do it):

```
// Zabbix GUI configuration file.
global $DB, $HISTORY;
```

Installing Elasticsearch and creating mapping

Final two steps of making things work are installing Elasticsearch itself and creating mapping process.

To install Elasticsearch please refer to [Elasticsearch installation guide](#).

Note:

Mapping is a data structure in Elasticsearch (similar to a table in a database). Mapping for all history data types is available here: `database/elasticsearch/elasticsearch.map`.

Warning:

Creating mapping is mandatory. Some functionality will be broken if mapping is not created according to the instruction.

To create mapping for text type send the following request to Elasticsearch:

```

curl -X PUT \
  http://your-elasticsearch.here:9200/text \
  -H 'content-type:application/json' \
  -d '{
    "settings": {
      "index": {
        "number_of_replicas": 1,
        "number_of_shards": 5
      }
    },
    "mappings": {
      "properties": {
        "itemid": {
          "type": "long"
        },
        "clock": {
          "format": "epoch_second",
          "type": "date"
        },
        "value": {
          "fields": {
            "analyzed": {
              "index": true,
              "type": "text",
              "analyzer": "standard"
            }
          },
          "index": false,
          "type": "text"
        }
      }
    }
  }'

```

Similar request is required to be executed for Character and Log history values mapping creation with corresponding type correction.

Note:

To work with Elasticsearch please refer to [Requirement page](#) for additional information.

Note:

Housekeeper is not deleting any data from Elasticsearch.

Storing history data in multiple date-based indices

This section describes additional steps required to work with pipelines and ingest nodes.

To begin with, you must create templates for indices.

The following example shows a request for creating uint template:

```

curl -X PUT \
  http://your-elasticsearch.here:9200/_template/uint_template \
  -H 'content-type:application/json' \
  -d '{
    "index_patterns": [
      "uint*"
    ],
    "settings": {
      "index": {
        "number_of_replicas": 1,
        "number_of_shards": 5
      }
    }
  },

```

```

"mappings": {
  "properties": {
    "itemid": {
      "type": "long"
    },
    "clock": {
      "format": "epoch_second",
      "type": "date"
    },
    "value": {
      "type": "long"
    }
  }
}
}'

```

To create other templates, user should change the URL (last part is the name of template), change "index_patterns" field to match index name and to set valid mapping, which can be taken from database/elasticsearch/elasticsearch.map.

For example, the following command can be used to create a template for text index:

```

curl -X PUT \
  http://your-elasticsearch.here:9200/_template/text_template \
  -H 'content-type:application/json' \
  -d '{
    "index_patterns": [
      "text*"
    ],
    "settings": {
      "index": {
        "number_of_replicas": 1,
        "number_of_shards": 5
      }
    },
    "mappings": {
      "properties": {
        "itemid": {
          "type": "long"
        },
        "clock": {
          "format": "epoch_second",
          "type": "date"
        },
        "value": {
          "fields": {
            "analyzed": {
              "index": true,
              "type": "text",
              "analyzer": "standard"
            }
          }
        },
        "index": false,
        "type": "text"
      }
    }
  }
}'

```

This is required to allow Elasticsearch to set valid mapping for indices created automatically. Then it is required to create the pipeline definition. Pipeline is some sort of preprocessing of data before putting data in indices. The following command can be used to create pipeline for uint index:

```

curl -X PUT \
  http://your-elasticsearch.here:9200/_ingest/pipeline/uint-pipeline \
  -H 'content-type:application/json' \

```



```
-d '{
  "description": "daily uint index naming",
  "processors": [
    {
      "date_index_name": {
        "field": "clock",
        "date_formats": [
          "UNIX"
        ],
        "index_name_prefix": "uint-",
        "date_rounding": "d"
      }
    }
  ]
}'
```

User can change the rounding parameter ("date_rounding") to set a specific index rotation period. To create other pipelines, user should change the URL (last part is the name of pipeline) and change "index_name_prefix" field to match index name.

See also [Elasticsearch documentation](#).

Additionally, storing history data in multiple date-based indices should also be enabled in the new parameter in Zabbix server configuration:

```
### Option: HistoryStorageDateIndex
# Enable preprocessing of history values in history storage to store values in different indices based on
# 0 - disable
# 1 - enable
#
# Mandatory: no
# Default:
# HistoryStorageDateIndex=0
```

Troubleshooting

The following steps may help you troubleshoot problems with Elasticsearch setup:

1. Check if the mapping is correct (GET request to required index URL like `http://localhost:9200/uint`).
2. Check if shards are not in failed state (restart of Elasticsearch should help).
3. Check the configuration of Elasticsearch. Configuration should allow access from the Zabbix frontend host and the Zabbix server host.
4. Check Elasticsearch logs.

If you are still experiencing problems with your installation then please create a bug report with all the information from this list (mapping, error logs, configuration, version, etc.)

8 Distribution-specific notes on setting up Nginx for Zabbix

RHEL

Nginx is available only in EPEL:

```
dnf -y install epel-release
```

SLES 15

In SUSE Linux Enterprise Server 15 you need to configure `php-fpm` (the path to configuration file may vary slightly depending on the service pack):

```
cp /etc/php8/fpm/php-fpm.conf{.default,}
cp /etc/php8/fpm/php-fpm.d/www.conf{.default,}
sed -i 's/user = nobody/user = wwwrun;/ s/group = nobody/group = www/' /etc/php8/fpm/php-fpm.d/www.conf
```

9 Running agent as root

Since Zabbix **5.0.0**, the `systemd` service file for Zabbix agent in [official packages](#) explicitly includes directives for `User` and `Group`. Both are set to `zabbix`.

It is no longer possible to configure which user Zabbix agent runs as via `zabbix_agentd.conf` file, because the agent will bypass this configuration and run as the user specified in the `systemd` service file. To run Zabbix agent as root you need to make the modifications described below.

Zabbix agent

To override the default user and group for Zabbix agent, run:

```
systemctl edit zabbix-agent
```

Then, add the following content:

```
[Service]
User=root
Group=root
```

Reload daemons and restart the `zabbix-agent` service:

```
systemctl daemon-reload
systemctl restart zabbix-agent
```

For **Zabbix agent** this re-enables the functionality of configuring user in the `zabbix_agentd.conf` file. Now you need to set `User=root` and `AllowRoot=1` configuration parameters in the agent [configuration file](#).

Zabbix agent 2

To override the default user and group for Zabbix agent 2, run:

```
systemctl edit zabbix-agent2
```

Then, add the following content:

```
[Service]
User=root
Group=root
```

Reload daemons and restart the `zabbix-agent` service:

```
systemctl daemon-reload
systemctl restart zabbix-agent2
```

For **Zabbix agent2** this completely determines the user that it runs as. No additional modifications are required.

10 Zabbix agent on Microsoft Windows

Configuring agent

Both generations of Zabbix agents run as a Windows service. For Zabbix agent 2, replace `agentd` with `agent2` in the instructions below.

You can run a single instance of Zabbix agent or multiple instances of the agent on a Microsoft Windows host. A single instance may use either:

- the default configuration file, located in the same directory as the agent binary;
- a configuration file specified in the command line.

In case of multiple instances each agent instance must have its own configuration file (one of the instances can use the default configuration file).

An example configuration file is available in the Zabbix source archive as:

- `conf/zabbix_agentd.conf` for Zabbix agent;
- `conf/zabbix_agent2.conf` for Zabbix agent2.

If you want to install Zabbix agent/agent 2 for Windows as a service from an [archive](#) without specifying the configuration file explicitly, then, before installing the agent:

- `conf/zabbix_agentd.conf` should be copied manually to the directory where `zabbix_agentd.exe` will be installed;
- `conf/zabbix_agent2.conf` and the `conf/zabbix_agent2.d` directory should be copied manually to the directory where `zabbix_agent2.exe` will be installed.

See the [configuration file](#) options for details on configuring Zabbix Windows agent.

Hostname parameter

To perform **active checks** on a host Zabbix agent needs to have the hostname defined. Moreover, the hostname value set on the agent side should exactly match the "Host name" configured for the host in the frontend.

The hostname value on the agent side can be defined by either the **Hostname** or **Hostnameltem** parameter in the agent **configuration file** - or the default values are used if any of these parameters are not specified.

The default value for **Hostnameltem** parameter is the value returned by the "system.hostname" agent key. For Windows, it returns result of the gethostname() function, which queries namespace providers to determine the local host name. If no namespace provider responds, the NetBIOS name is returned.

The default value for **Hostname** is the value returned by the Hostnameltem parameter. So, in effect, if both these parameters are unspecified, the actual hostname will be the host NetBIOS name; Zabbix agent will use NetBIOS host name to retrieve the list of active checks from Zabbix server and send results to it.

The "system.hostname" key supports two optional parameters - *type* and *transform*.

Type determines the type of the name the item should return:

- *netbios* (default) - returns the NetBIOS host name which is limited to 15 symbols and is in the UPPERCASE only;
- *host* - case-sensitive, returns the full, real Windows host name (without a domain);
- *shorthost* - returns part of the hostname before the first dot. It will return a full string if the name does not contain a dot.
- *fqdn* - returns Fully Qualified Domain Name (without the trailing dot).

Transform allows to specify additional transformation rule for the hostname:

- *none* (default) - use the original letter case;
- *lower* - convert the text into lowercase.

So, to simplify the configuration of zabbix_agentd.conf file and make it unified, three different approaches can be used:

1. Leave **Hostname** or **Hostnameltem** parameters undefined and Zabbix agent will use NetBIOS host name as the hostname.
2. Leave **Hostname** parameter undefined and define **Hostnameltem** like this:

Hostnameltem=system.hostname[host] - for Zabbix agent to use the full, real (case-sensitive) Windows host name as the hostname

Hostnameltem=system.hostname[shorthost,lower] - for Zabbix agent to use only part of the hostname before the first dot, converted into lowercase.

Hostnameltem=system.hostname[fqdn] - for Zabbix agent to use the Fully Qualified Domain Name as the hostname.

Host name is also used as part of Windows service name which is used for installing, starting, stopping and uninstalling the Windows service. For example, if Zabbix agent configuration file specifies `Hostname=Windows_db_server`, then the agent will be installed as a Windows service "Zabbix Agent [Windows_db_server]". Therefore, to have a different Windows service name for each Zabbix agent instance, each instance must use a different host name.

Installing agent as Windows service

Before installing the agent, copy `conf/zabbix_agentd.conf` manually to the directory where `zabbix_agentd.exe` will be installed.

To install a single instance of Zabbix agent with the default configuration file:

```
zabbix_agentd.exe --install
```

Attention:

On a 64-bit system, a 64-bit Zabbix agent version is required for all checks related to running 64-bit processes to work correctly.

If you wish to use a configuration file other than the default one, you should use the following command for service installation:

```
zabbix_agentd.exe --config <your_configuration_file> --install
```

A full path to the configuration file should be specified.

Multiple instances of Zabbix agent can be installed as services like this:

```
zabbix_agentd.exe --config <configuration_file_for_instance_1> --install --multiple-agents
zabbix_agentd.exe --config <configuration_file_for_instance_2> --install --multiple-agents
...
zabbix_agentd.exe --config <configuration_file_for_instance_N> --install --multiple-agents
```

The installed service should now be visible in Control Panel.

Starting agent

To start the agent service, you can use Control Panel or do it from command line.

To start a single instance of Zabbix agent with the default configuration file:

```
zabbix_agentd.exe --start
```

To start a single instance of Zabbix agent with another configuration file:

```
zabbix_agentd.exe --config <your_configuration_file> --start
```

To start one of multiple instances of Zabbix agent:

```
zabbix_agentd.exe --config <configuration_file_for_this_instance> --start --multiple-agents
```

Stopping agent

To stop the agent service, you can use Control Panel or do it from command line.

To stop a single instance of Zabbix agent started with the default configuration file:

```
zabbix_agentd.exe --stop
```

To stop a single instance of Zabbix agent started with another configuration file:

```
zabbix_agentd.exe --config <your_configuration_file> --stop
```

To stop one of multiple instances of Zabbix agent:

```
zabbix_agentd.exe --config <configuration_file_for_this_instance> --stop --multiple-agents
```

Uninstalling agent Windows service

To uninstall a single instance of Zabbix agent using the default configuration file:

```
zabbix_agentd.exe --uninstall
```

To uninstall a single instance of Zabbix agent using a non-default configuration file:

```
zabbix_agentd.exe --config <your_configuration_file> --uninstall
```

To uninstall multiple instances of Zabbix agent from Windows services:

```
zabbix_agentd.exe --config <configuration_file_for_instance_1> --uninstall --multiple-agents
zabbix_agentd.exe --config <configuration_file_for_instance_2> --uninstall --multiple-agents
...
zabbix_agentd.exe --config <configuration_file_for_instance_N> --uninstall --multiple-agents
```

Limitations

Zabbix agent for Windows does not support non-standard Windows configurations where CPUs are distributed non-uniformly across NUMA nodes. If logical CPUs are distributed non-uniformly, then CPU performance metrics may not be available for some CPUs. For example, if there are 72 logical CPUs with 2 NUMA nodes, both nodes must have 36 CPUs each.

11 SAML setup with Microsoft Entra ID

Overview

This section provides guidelines for configuring single sign-on and user provisioning into Zabbix from Microsoft Entra ID (formerly Microsoft Azure Active Directory) using SAML 2.0 authentication.

Microsoft Entra ID configuration

Creating application

1. Log into Microsoft Entra admin center at [Microsoft Entra ID](#). For testing purposes, you may create a free trial account in Microsoft Entra ID.
2. In Microsoft Entra admin center select *Applications* -> *Enterprise applications* -> *New application* -> *Create your own application*.
3. Add the name of your app and select the *Integrate any other application...* option. After that, click on *Create*.

What's the name of your app?

 ✓

What are you looking to do with your application?

- Configure Application Proxy for secure remote access to an on-premises application
- Register an application to integrate with Microsoft Entra ID (App you're developing)
- Integrate any other application you don't find in the gallery (Non-gallery)

Setting up single sign-on

1. In your application page, go to *Set up single sign on* and click on *Get started*. Then select *SAML*.
2. Edit *Basic SAML Configuration*:
 - In *Identifier (Entity ID)* set a unique name to identify your app to Microsoft Entra ID, for example, `zabbix`;
 - In *Reply URL (Assertion Consumer Service URL)* set the Zabbix single sign-on endpoint: `https://<path-to-zabbix-ui>/index_sso.php?acs`

Identifier (Entity ID) * ⓘ

The unique ID that identifies your application to Microsoft Entra ID. This value must be unique across all applications in your Microsoft Entra tenant. The default identifier will be the audience of the SAML response for IDP-initiated SSO.

	Default
zabbix	✓ ⓘ 🗑️

[Add identifier](#)

Reply URL (Assertion Consumer Service URL) * ⓘ

The reply URL is where the application expects to receive the authentication token. This is also referred to as the "Assertion Consumer Service" (ACS) in SAML.

	Ind...	Default
<input type="text" value="https://path-to-zabbix-ui/index_sso.php?acs"/> ✓	<input type="text" value=""/> ✓	✓ ⓘ 🗑️

Note that "https" is required. To make that work with Zabbix, it is necessary to add to `conf/zabbix.conf.php` the following line:

```
$SSO['SETTINGS'] = ['use_proxy_headers' => true];
```

3. Edit *Attributes & Claims*. You must add all attributes that you want to pass to Zabbix (`user_name`, `user_lastname`, `user_email`, `user_mobile`, `groups`).

The attribute names are arbitrary. Different attribute names may be used, however, it is required that they match the respective field value in Zabbix SAML settings.

- Click on *Add new claim* to add an attribute:

Name *

Namespace

∨ Choose name format

Source *

Attribute Transformation

Source attribute *

- Click on *Add a group claim* to add an attribute for passing groups to Zabbix:

Group Claims



Manage the group claims used by Microsoft Entra ID to populate SAML tokens issued to your app

Which groups associated with the user should be returned in the claim?

- None
- All groups
- Security groups
- Directory roles
- Groups assigned to the application

Source attribute *

Emit group name for cloud-only groups ⓘ

^ Advanced options

Filter groups

Attribute to match

Match with

String

Customize the name of the group claim

Name (required)

Save

It is important in this claim that the group names (rather than group IDs) are passed to Zabbix by the selected *Source attribute*. Otherwise JIT user provisioning will not work properly.

4. In *SAML Certificates* download the Base64 certificate provided by Entra ID and place it into `conf/certs` of the Zabbix frontend installation.

Set 644 permissions to it by running:

```
chmod 644 entra.cer
```

Make sure that `conf/zabbix.conf.php` contains the line:

```
$SSO['IDP_CERT'] = 'conf/certs/entra.cer';
```

5. Use the values from *Set up <your app name>* in Entra ID to configure Zabbix SAML authentication (see next section):

4

Set up Zabbix SAML/SCIM

You'll need to configure the application to link with Microsoft Entra ID.

Login URL	<code>https://login.microsoftonline.com/38c221ff-4 ...</code>
Microsoft Entra Identifier	<code>https://sts.windows.net/38c221ff-42f4-4ec0-8...</code>
Logout URL	<code>https://login.microsoftonline.com/38c221ff-4 ...</code>

Zabbix configuration

1. In Zabbix, go to the **SAML settings** and fill the configuration options based on the Entra ID configuration:

Enable SAML authentication

Enable JIT provisioning

* IdP entity ID

* SSO service URL

SLO service URL

* Username attribute

* SP entity ID

SP name ID format

- Sign Messages
 Assertions
 AuthN requests
 Logout requests
 Logout responses

- Encrypt Name ID
 Assertions

Case-sensitive login

Configure JIT provisioning

* Group name attribute

User name attribute

User last name attribute

* User group mapping

SAML group pattern	User groups	User role	Action
Zabbix admin	Zabbix administrators	Super admin role	Remove
Add			

Media type mapping ?

Name	Media type	Attribute	Action
Email	Email	user_email	Remove
Mobile	SMS	user_mobile	Remove
Add			

Enable SCIM provisioning

Zabbix field	Setup field in Entra ID	Sample value
<i>IdP entity ID</i>	Microsoft Entra identifier	
<i>SSO service URL</i>	Login URL	
<i>SLO service URL</i>	Logout URL	
<i>SP entity ID</i>	Identifier (Entity ID)	
<i>Username attribute</i>	Custom attribute (claim)	user_email
<i>Group name attribute</i>	Custom attribute (claim)	groups
<i>User name attribute</i>	Custom attribute (claim)	user_name

Zabbix field	Setup field in Entra ID	Sample value
<i>User last name attribute</i>	Custom attribute (claim)	user_lastname

It is also required to configure user group mapping. Media mapping is optional.

Click on *Update* to save these settings.

SCIM user provisioning

1. In your Entra ID application page, from the main menu open the Provisioning page. Click on *Get started* and then select Automatic provisioning mode:

- In *Tenant URL*, set the following value: `https://<path-to-zabbix-ui>/api_scim.php`
- In *Secret token*, enter a Zabbix API token with Super admin permissions.
- Click on *Test connection* to see if the connection is established.

Provisioning Mode

Use Microsoft Entra to manage the creation and synchronization of user accounts in Zabbix SAML/SCIM based on user and group assignment.

Admin Credentials

Admin Credentials

Microsoft Entra needs the following information to connect to Zabbix SAML/SCIM's API and synchronize user data.

Tenant URL * ⓘ

Secret Token

2. Now you can add all the attributes that will be passed with SCIM to Zabbix. To do that, click on *Mappings* and then on *Provision Microsoft Entra ID Users*.

Mappings

Mappings

Mappings allow you to define how data should flow between Microsoft Entra ID and customappsso.

Name	Enabled
Provision Microsoft Entra ID Groups	Yes
Provision Microsoft Entra ID Users	Yes

 Restore default mappings

At the bottom of the Attribute Mapping list, enable *Show advanced options*, and then click on *Edit attribute list for customappsso*.

At the bottom of the attribute list, add your own attributes with type 'String':

urn:ietf:params:scim:schema...	Reference	<input type="checkbox"/>	<input type="checkbox"/>
user_name	String	<input type="checkbox"/>	<input type="checkbox"/>
user_lastname	String	<input type="checkbox"/>	<input type="checkbox"/>
user_email ✓	String	<input type="checkbox"/>	<input type="checkbox"/>
	String	<input type="checkbox"/>	<input type="checkbox"/>

Save the list.

3. Now you can add mappings for the added attributes. At the bottom of the Attribute Mapping list, click on *Add New Mapping* and create mappings as shown below:

Mapping type ⓘ

Source attribute * ⓘ

Default value if null (optional) ⓘ

Target attribute * ⓘ

When all mappings are added, save the list of mappings.

Save Discard

department	urn:ietf:params:scim:schemas:exten...
manager	urn:ietf:params:scim:schemas:exten...
givenName	user_name
mobile	user_mobile
surname	user_lastname
mail	user_email

4. As a prerequisite of user provisioning into Zabbix, you must have users and groups configured in Entra ID.

To do that, go to *Microsoft Entra admin center* and then add users/groups in the respective Users and Groups pages.

5. When users and groups have been created in Entra ID, you can go to the *Users and groups* menu of your application and add them to the app.

6. Go to the *Provisioning* menu of your app, and click on *Start provisioning* to have users provisioned to Zabbix.

Note that the Users PATCH request in Entra ID does not support changes in media.

12 SAML setup with Okta

This section provides guidelines for configuring [Okta](#) to enable SAML 2.0 authentication and user provisioning for Zabbix.

Okta configuration

1. Go to <https://developer.okta.com/signup/> and register/sign into your account.
2. In the Okta web interface navigate to *Applications* → *Applications*.
3. Click on *Create App Integration*.

Create a new app integration

X

Sign-in method

[Learn More](#)

- OIDC - OpenID Connect**
Token-based OAuth 2.0 authentication for Single Sign-On (SSO) through API endpoints. Recommended if you intend to build a custom app integration with the Okta Sign-In Widget.
- SAML 2.0**
XML-based open standard for SSO. Use if the Identity Provider for your application only supports SAML.
- SWA - Secure Web Authentication**
Okta-specific SSO method. Use if your application doesn't support OIDC or SAML.
- API Services**
Interact with Okta APIs using the scoped OAuth 2.0 access tokens for machine-to-machine authentication.

Cancel

Next

Select "SAML 2.0" as the sign-in method and click on *Next*.

4. In general settings, fill in the app name and click on *Next*.

5. In SAML configuration, enter the values provided below, then click on *Next*.

A SAML Settings

General

Single sign-on URL ?
 Use this for Recipient URL and Destination URL

Audience URI (SP Entity ID) ?

Default RelayState ?
If no value is set, a blank RelayState is sent

- In **General** add:

- *Single sign-on URL*: `http://<your-zabbix-url>/zabbix/index_sso.php?acs`
Note the use of "http", and not "https", so that the acs parameter is not cut out in the request. The *Use this for Recipient URL and Destination URL* checkbox should also be marked.
- *Audience URI (SP Entity ID)*: `zabbix`
Note that this value will be used within the SAML assertion as a unique service provider identifier (if not matching, the operation will be rejected). It is possible to specify a URL or any string of data in this field.
- *Default RelayState*:
Leave this field blank; if a custom redirect is required, it can be added in Zabbix in the *Users* → *Users* settings.
- Fill in other fields according to your preferences.

- In **Attribute Statements/Group Attribute Statements** add:

Attribute Statements (optional)

[LEARN MORE](#)

Name	Name format (optional)	Value	
usrEmail	Unspecified ▼	user.email ▼	
user_name	Unspecified ▼	user.firstName ▼	×
user_lastname	Unspecified ▼	user.lastName ▼	×
user_mobile	Unspecified ▼	user.mobilePhone ▼	×

[Add Another](#)

Group Attribute Statements (optional)

Name	Name format (optional)	Filter
groups	Unspecified ▼	Matches regex ▼ .*zabbix.*

These attribute statements are inserted into the SAML assertions shared with Zabbix.

The attribute names used here are arbitrary examples. You may use different attribute names, however, it is required that they match the respective field value in Zabbix SAML settings.

If you want to configure SAML sign-in into Zabbix *without* JIT user provisioning, then only the email attribute is required.

Note:

If planning to use an encrypted connection, generate the private and public encryption certificates, then upload the public certificate to Okta. The certificate upload form appears when *Assertion Encryption* is set to "Encrypted" (click *Show Advanced Settings* to find this parameter).

6. In the next tab, select "I'm a software vendor. I'd like to integrate my app with Okta" and press "Finish".

7. Navigate to the "Assignments" tab of the newly-created application and click on the *Assign* button, then select "Assign to People" from the drop-down.

General Sign On Provisioning Import Assignments Push Groups

Assign ▼ Convert assignments ▼ Search...

Assign to People

Assign to Groups

Type

8. In a popup that appears, assign the app to people that will use SAML 2.0 to authenticate with Zabbix, then click on *Save and go back*.

9. Navigate to the "Sign On" tab and click on the *View Setup Instructions* button.

Setup **instructions** will be opened in a new tab; keep this tab open while configuring Zabbix.

Zabbix configuration

1. In Zabbix, go to the **SAML settings** and fill the configuration options based on setup instructions from Okta:

Enable SAML authentication

Enable JIT provisioning

* IdP entity ID

* SSO service URL

SLO service URL

* Username attribute

* SP entity ID

SP name ID format

- Sign Messages
 Assertions
 AuthN requests
 Logout requests
 Logout responses

- Encrypt Name ID
 Assertions

Case-sensitive login

Configure JIT provisioning

* Group name attribute

User name attribute

User last name attribute

* User group mapping

SAML group pattern	User groups	User role	Action
zabbix-admin	Zabbix administrators	Super admin role	Remove
zabbix*	Zabbix users	User role	Remove
Add			

Media type mapping ?

Name	Media type	Attribute	Action
Mobile	SMS	user_mobile	Remove
Email	Email	usrEmail	Remove
Add			

Enable SCIM provisioning

[Update](#)

Zabbix field	Setup field in Okta	Sample value
<i>IdP entity ID</i>	Identity Provider Issuer	
<i>SSO service URL</i>	Identity Provider Single Sign-On URL	
<i>Username attribute</i>	Attribute name	usrEmail
<i>SP entity ID</i>	Audience URI	zabbix
<i>Group name attribute</i>	Attribute name	groups

Zabbix field	Setup field in Okta	Sample value
<i>User name attribute</i>	Attribute name	user_name
<i>User last name attribute</i>	Attribute name	user_lastname

It is also required to configure user group and media mapping.

2. Download the certificate provided in the Okta SAML setup instructions into *ui/conf/certs* folder as *idp.crt*.

Set 644 permissions to it by running:

```
chmod 644 idp.crt
```

3. If *Assertion Encryption* has been set to "Encrypted" in Okta, the "Assertions" checkbox of the *Encrypt* parameter should be marked in Zabbix as well.

4. Press the "Update" button to save these settings.

SCIM provisioning

1. To turn on SCIM provisioning, go to "General" -> "App Settings" of the application in Okta.

Mark the *Enable SCIM provisioning* checkbox. As a result, a new *Provisioning* tab appears.

2. Go to the "Provisioning" tab to set up a SCIM connection:

- In *SCIM connector base URL* specify the path to the Zabbix frontend and append *api_scim.php* to it, i.e.:
`https://<your-zabbix-url>/zabbix/api_scim.php`
- *Unique identifier field for users*: email
- *Authentication mode*: HTTP header
- In *Authorization* enter a valid API token with Super admin rights

General Sign On Provisioning Import Assignments

Settings

Integration

SCIM Connection Cancel

SCIM version 2.0

SCIM connector base URL

Unique identifier field for users

Supported provisioning actions

- Import New Users and Profile Updates
- Push New Users
- Push Profile Updates
- Push Groups
- Import Groups

Authentication Mode

HTTP Header

Authorization

Test Connector Configuration

Save
Cancel

Attention:

If you are using Apache, you may need to change the default Apache configuration in */etc/apache2/apache2.conf* by adding the following line:

```
SetEnvIf Authorization "(.*)" HTTP_AUTHORIZATION=$1
```

Otherwise, Apache might not send the Authorization header in the request.

3. Click on *Test Connector Configuration* to test the connection. If all is correct a success message will be displayed.

4. In "Provisioning" -> "To App", make sure to mark the following checkboxes:

- Create Users
- Update User Attributes
- Deactivate Users

This will make sure that these request types will be sent to Zabbix.

5. Make sure that all attributes defined in SAML are defined in SCIM. You can access the profile editor for your app in "Provisioning" -> "To App", by clicking on *Go to Profile Editor*.

Click on *Add Attribute*. Fill the values for *Display name*, *Variable name*, *External name* with the SAML attribute name, for example, `user_name`.

Add Attribute

* Local app attributes are only stored on Okta and not created in Zabbix-SAML. Use local attributes if you plan to add the attribute to Zabbix-SAML or only want to store the mapped value in Okta.

Data type	<input type="text" value="string"/>
Display name ?	<input type="text" value="user_name"/>
Variable name ?	<input type="text" value="user_name"/>
External name ?	<input type="text" value="user_name"/>
External namespace ?	<input type="text" value="urn:ietf:params:scim:schemas:core:2.0:User"/>
Description	<input type="text"/>

External namespace should be the same as user schema: `urn:ietf:params:scim:schemas:core:2.0:User`

6. Go to "Provisioning" -> "To App" -> "Attribute Mappings" of your application. Click on *Show Unmapped Attributes* at the bottom. Newly added attributes appear.

7. Map each added attribute.

Zabbix-SAML - user_name

Attribute value

Map from Okta Pr...

firstName | string

"Martins"

Apply on

Create

Create and update

Preview

Martins Vvvv

Save

Cancel

8. Add users in the "Assignments" tab. The users previously need to be added in *Directory* -> *People*. All these assignments will be sent as requests to Zabbix.

9. Add groups in the "Push Groups" tab. The user group mapping pattern in Zabbix SAML settings must match a group specified here. If there is no match, the user cannot be created in Zabbix.

Information about group members is sent every time when some change is made.

13 SAML setup with OneLogin

Overview

This section provides guidelines for configuring single sign-on and user provisioning into Zabbix from [OneLogin](#) using SAML 2.0 authentication.

OneLogin configuration

Creating application

1. Log into your account at OneLogin. For testing purposes, you may create a free developer account in OneLogin.
2. In the OneLogin web interface navigate to *Applications* → *Applications*.
3. Click on "Add App" and search for the appropriate app. The guidelines in this page are based on the *SCIM Provisioner with SAML (SCIM v2 Enterprise, full SAML)* app example.
4. To begin with, you may want to customize the display name of your app. You may also want to add the icon and app details. After that, click on *Save*.

Setting up SSO/SCIM provisioning

1. In *Configuration* -> *Application details*, set the Zabbix single sign-on endpoint `http://<zabbix-instance-url>/zabbix/index_sso.php` as the value of these fields:
 - *ACS (Consumer) URL Validator*
 - *ACS (Consumer) URL*

Note the use of "http", and not "https", so that the acs parameter is not cut out in the request.

Info	Application details
Configuration	SAML Audience URL
Parameters	<input type="text"/>
Rules	RelayState
SSO	<input type="text"/>
Access	Recipient
Provisioning	<input type="text"/>
Users	ACS (Consumer) URL Validator*
Privileges	<input type="text" value="http://<zabbix-instance-url>/zabbix/index_sso.php?acs"/>
	 ⓘ *Required.
	ACS (Consumer) URL*
	<input type="text" value="http://<zabbix-instance-url>/zabbix/index_sso.php?acs"/>

It is also possible to use "https". To make that work with Zabbix, it is necessary to add to `conf/zabbix.conf.php` the following line:

```
$SSO['SETTINGS'] = ['use_proxy_headers' => true];
```

Leave other options with their default values.

2. In *Configuration -> API connection*, set the following values:

- *SCIM Base URL*: `https://<zabbix-instance-url>/zabbix/api_scim.php`
- *SCIM JSON Template*: should contain all custom attributes that you would like to pass to Zabbix via SCIM such as `user_name`, `user_lastname`, `user_email`, and `user_mobile`:

```
{
  "schemas": [
    "urn:ietf:params:scim:schemas:core:2.0:User"
  ],
  "userName": "{$parameters.scimusername}",
  "name": {
    "familyName": "{$user.lastname}",
    "givenName": "{$user.firstname}"
  },
  "user_name": "{$user.firstname}",
  "user_lastname": "{$user.lastname}",
  "user_mobile": "{$user.phone}",
  "user_email": "{$user.email}"
}
```

The attribute names are arbitrary. Different attribute names may be used, however, it is required that they match the respective field value in Zabbix SAML settings.

Note that for user provisioning to work, OneLogin needs to receive in response a 'name' attribute with 'givenName' and 'family-Name', even if it was not required by the service provider. Thus it is necessary to specify this in the schema in the application configuration part.

- *SCIM Bearer Token*: enter a Zabbix API token with Super admin permissions.

Click on *Enable* to activate the connection.

API Connection

API Status
 Enabled Disable

SCIM Base URL

SCIM JSON Template

```
{
  "schemas": [
    "urn:ietf:params:scim:schemas:core:2.0:User"
  ],
  "userName": "${parameters.scimusername}",
  "name": {
    "familyName": "${user.lastname}",
    "givenName": "${user.firstname}"
  },
  "user_name": "${user.firstname}",
  "user_lastname": "${user.lastname}",
  "user_mobile": "${user.phone}",
  "user_email": "${user.email}"
}
```

Custom Headers

SCIM Bearer Token

3. In the *Provisioning* page, enable the Provisioning option:

Workflow

Enable provisioning

Require admin approval before this action is performed

Create user
 Delete user
 Update user

When users are deleted in OneLogin, or the user's app access is removed, perform the below action

When user accounts are suspended in OneLogin, perform the following action:

4. The *Parameters* page contains a list of default parameters:

- Make sure that the 'scimusername' matches the user login value in OneLogin (e.g. email);
- Mark the *Include in User Provisioning* option for the 'Groups' parameter;
- Click on "+" to create the custom parameters that are required for SAML assertions and user provisioning such as user_name, user_lastname, user_email, and user_mobile:

Edit Field user_email

Name

user_email

Value

Flags

- Include in SAML assertion
- Include in User Provisioning

Cancel

Delete

Save

When adding a parameter, make sure to mark both the *Include in SAML assertion* and *Include in User Provisioning* options.

- Add a 'group' parameter that matches user roles in OneLogin. User roles will be passed as a string, separated by a semicolon ;. The OneLogin user roles will be the used for creating user groups in Zabbix:

Edit Field group

Name
group

Value

User Roles

Flags

- Include in SAML assertion
- Include in User Provisioning

Cancel

Delete

Save

Verify the list of parameters:

Info

Configuration

Parameters

Rules

SSO

Access

Provisioning

Users

Privileges

Credentials are

Configured by admin

Configured by admins and shared by all users (no provisioning)

SCIM Provisioner with SAML (SCIM v2 Enterprise, full SAML) Field	Value	
Groups	-No transform- (Single value output)	
Manager ID	- User Manager -	
SAML NameID (Subject)	Email	
department	Department	
group	User Roles	custom parameter
scimusername	Email	
title	Title	
user_email	Email	custom parameter
user_lastname	Last Name	custom parameter
user_mobile	Phone	custom parameter
user_name	First Name	custom parameter

5. In the *Rules* page, create user role mappings to the default Groups parameter.

Edit mapping

Name

Role to group 2

Conditions

No conditions. Actions will apply to all users.



Actions

Set Groups in Zabbix with SAML (SCIM v2 Enterpr... ▼

From Existing

Map from OneLogin

For each

with value that matches

set Zabbix with SAML (SCIM v2 Enterprise, full SAML) Groups named after **roles**.

You may use a regular expression to pass specific roles as groups. The role names should not contain ; as OneLogin uses it as a separator when sending an attribute with several roles.

Zabbix configuration

1. In Zabbix, go to the [SAML settings](#) and fill the configuration options based on the OneLogin configuration:

Enable SAML authentication

Enable JIT provisioning

* IdP entity ID

* SSO service URL

SLO service URL

* Username attribute

* SP entity ID

SP name ID format

- Sign Messages
 Assertions
 AuthN requests
 Logout requests
 Logout responses

- Encrypt Name ID
 Assertions

Case-sensitive login

Configure JIT provisioning

* Group name attribute

User name attribute

User last name attribute

* User group mapping

SAML group pattern	User groups	User role	Action
Dev*	Zabbix administrators	Admin role	Remove
User	Zabbix users	User role	Remove
Zabbix*	Zabbix administrators	Super admin role	Remove
Add			

Media type mapping ?

Name	Media type	Attribute	Action
Email	Email	user_email	Remove
Mobile	SMS	user_mobile	Remove
Add			

Enable SCIM provisioning

[Update](#)

Zabbix field	Setup field in OneLogin	Sample value
IdP entity ID	Issuer URL (see SSO tab of your application in OneLogin)	
SSO service URL	SAML 2.0 Endpoint (HTTP) (see SSO tab of your application in OneLogin)	

Zabbix field	Setup field in OneLogin	Sample value
<i>SLO service URL</i>	SLO Endpoint (HTTP) (see SSO tab of your application in OneLogin)	
<i>Username attribute</i>	Custom parameter	user_email
<i>Group name attribute</i>	Custom parameter	group
<i>User name attribute</i>	Custom parameter	user_name
<i>User last name attribute</i>	Custom parameter	user_lastname

It is also required to configure user group mapping. Media mapping is optional. Click on *Update* to save these settings.

2. Download the certificate provided by OneLogin and place it into `conf/certs` of the Zabbix frontend installation, as `idp.crt`.

Set 644 permissions to it by running:

```
chmod 644 idp.crt
```

You can access the certificate download in OneLogin in *Applications* -> *SSO* -> click on *View details* under the current certificate.

It is possible to use a different certificate name and location. In that case, make sure to add to `conf/zabbix.conf.php` the following line:

```
$SSO['IDP_CERT'] = 'path/to/certname.crt';
```

SCIM user provisioning

With user provisioning enabled, it is now possible to add/update users and their roles in OneLogin and have them immediately provisioned to Zabbix.

For example, you may create a new user:

Add it to a user role and the application that will provision the user:

When saving the user, it will be provisioned to Zabbix. In *Application* -> *Users* you can check the provisioning status of current application users:

Info	Search	All roles	All groups	Any status
Configuration	User		Provisioning State	
Parameters	Example User		 Provisioned	
Rules				

If successfully provisioned, the user can be seen in the Zabbix user list.

<input type="checkbox"/>	Username ▲	Name	Last name	User role	Groups	Is online?	Login	Frontend access
<input type="checkbox"/>	Admin	Zabbix	Administrator	Super admin role	Zabbix administrators	Yes (2023-04-18 21:11:43)	Ok	System default
<input type="checkbox"/>	example.user@example.com	Example	User	Admin role	Zabbix administrators	No	Ok	SAML

14 Setting up scheduled reports

Overview

This section provides instructions on installing Zabbix web service and configuring Zabbix to enable generation of **scheduled reports**.

Installation

A new **Zabbix web service** process and Google Chrome browser should be installed to enable generation of scheduled reports. The web service may be installed on the same machine where the Zabbix server is installed or on a different machine. Google Chrome browser should be installed on the same machine, where the web service is installed.

The official zabbix-web-service package is available in the [Zabbix repository](#). Google Chrome browser is not included into these packages and has to be installed separately.

To compile Zabbix web service from sources, see [Installing Zabbix web service](#).

After the installation, run `zabbix_web_service` on the machine, where the web service is installed:

```
zabbix_web_service
```

Configuration

To ensure proper communication between all elements involved make sure server configuration file and frontend configuration parameters are properly configured.

Zabbix server

The following parameters in Zabbix server configuration file need to be updated: `WebServiceURL` and `StartReportWriters`.

WebServiceURL

This parameter is required to enable communication with the web service. The URL should be in the format `<host:port>/report`.

- By default, the web service listens on port 10053. A different port can be specified in the web service [configuration file](#).
- Specifying the `/report` path is mandatory (the path is hardcoded and cannot be changed).

Example:

```
WebServiceURL=http://localhost:10053/report
```

Attention:

It is strongly recommended to set up encryption between Zabbix server and Zabbix web service [using certificates](#). By default, data transmitted between Zabbix server and Zabbix web service is not encrypted, which can lead to unauthorized access.

StartReportWriters

This parameter determines how many report writer processes should be started. If it is not set or equals 0, report generation is disabled. Based on the number and frequency of reports required, it is possible to enable from 1 to 100 report writer processes.

Example:

```
StartReportWriters=3
```

Zabbix frontend

A *Frontend URL* parameter should be set to enable communication between Zabbix frontend and Zabbix web service:

- Proceed to the *Administration* → *General* → *Other parameters* frontend menu section
- Specify the full URL of the Zabbix web interface in the *Frontend URL* parameter

Other configuration parameters ▼

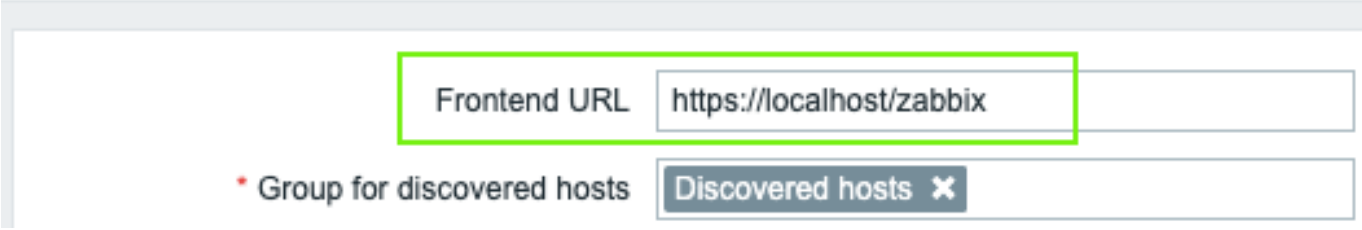

The screenshot shows a configuration form with two input fields. The first field is labeled 'Frontend URL' and contains the text 'https://localhost/zabbix'. The second field is labeled 'Group for discovered hosts' and contains the text 'Discovered hosts' with a close button (X) to its right. Below the fields is a blue-bordered box containing a 'Note'.

Note:
Once the setup procedure is completed, you may want to configure and send a **test report** to make sure everything works correctly.

15 Additional frontend languages

Overview

In order to use any other language than English in Zabbix web interface, its locale should be installed on the web server. Additionally, the PHP gettext extension is required for the translations to work.

Installing locales

To list all installed languages, run:

```
locale -a
```

If some languages that are needed are not listed, open the `/etc/locale.gen` file and uncomment the required locales. Since Zabbix uses UTF-8 encoding, you need to select locales with UTF-8 charset.

Now run:

```
locale-gen
```

Restart the web server.

The locales should now be installed. It may be required to reload Zabbix frontend page in browser using Ctrl + F5 for new languages to appear.

Installing Zabbix

If installing Zabbix directly from [Zabbix git repository](#), translation files should be generated manually. To generate translation files, run:

```
make gettext  
locale/make_mo.sh
```

This step is not needed when installing Zabbix from packages or source tar.gz files.

Selecting a language

There are several ways to select a language in Zabbix web interface:

- When installing web interface - in the frontend **installation wizard**. Selected language will be set as system default.
- After the installation, system default language can be changed in the *Administration*→*General*→*GUI menu section*.
- Language for a particular user can be changed in the **user profile**.

If a locale for a language is not installed on the machine, this language will be greyed out in Zabbix language selector. An orange icon is displayed next to the language selector if at least one locale is missing. Upon pressing on this icon the following message will be displayed: "You are not able to choose some of the languages, because locales for them are not installed on the web server."

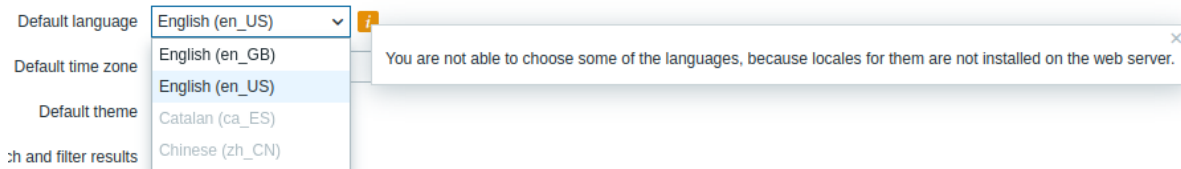

2 Process configuration

Please use the sidebar to access content in this section.

1 Zabbix server

Overview

The parameters supported by the Zabbix server configuration file (zabbix_server.conf) are listed in this section.

The parameters are listed without additional information. Click on the parameter to see the full details.

Parameter	Description
AlertScriptsPath	The location of custom alert scripts.
AllowRoot	Allow the server to run as 'root'.
AllowSoftwareUpdateCheck	Allow Zabbix UI to receive information about software updates from zabbix.com.
AllowUnsupportedDBVersions	Allow the server to work with unsupported database versions.
CacheSize	The size of the configuration cache.
CacheUpdateFrequency	This parameter determines how often Zabbix will perform the configuration cache update in seconds.
DBHost	The database host name.
DBName	The database name.
DBPassword	The database password.
DBPort	The database port when not using local socket.
DBSchema	The database schema name. Used for PostgreSQL.
DBSocket	The path to the MySQL socket file.
DBUser	The database user.
DBTLSConnect	Setting this option to the specified value enforces to use a TLS connection to the database.
DBTLSCAFile	The full pathname of a file containing the top-level CA(s) certificates for database certificate verification.
DBTLSCertFile	The full pathname of a file containing the Zabbix server certificate for authenticating to database.
DBTLSKeyFile	The full pathname of a file containing the private key for authenticating to database.
DBTLSCipher	The list of encryption ciphers that Zabbix server permits for TLS protocols up through TLS v1.2. Supported only for MySQL.
DBTLSCipher13	The list of encryption ciphersuites that Zabbix server permits for the TLS v1.3 protocol. Supported only for MySQL, starting from version 8.0.16.
DebugLevel	Specify the debug level.
EnableGlobalScripts	Enable global scripts on Zabbix server.
ExportDir	The directory for real-time export of events, history and trends in newline-delimited JSON format. If set, enables the real-time export.
ExportFileSize	The maximum size per export file in bytes.
ExportType	The list of comma-delimited entity types (events, history, trends) for real-time export (all types by default).
ExternalScripts	The location of external scripts.
Fping6Location	The location of fping6.
FpingLocation	The location of fping.
HANodeName	The high availability cluster node name.
HistoryCacheSize	The size of the history cache.
HistoryIndexCacheSize	The size of the history index cache.
HistoryStorageDateIndex	Enable preprocessing of history values in history storage to store values in different indices based on date.
HistoryStorageURL	The history storage HTTP[S] URL.
HistoryStorageTypes	A comma-separated list of value types to be sent to the history storage.
HousekeepingFrequency	This parameter determines how often Zabbix will perform the housekeeping procedure in hours.

Parameter	Description
Include	You may include individual files or all files in a directory in the configuration file.
JavaGateway	The IP address (or hostname) of Zabbix Java gateway.
JavaGatewayPort	The port that Zabbix Java gateway listens on.
ListenBacklog	The maximum number of pending connections in the TCP queue.
ListenIP	A list of comma-delimited IP addresses that the trapper should listen on.
ListenPort	The listen port for trapper.
LoadModule	The module to load at server startup.
LoadModulePath	The full path to the location of server modules.
LogFile	The name of the log file.
LogFileSize	The maximum size of the log file.
LogSlowQueries	Determines how long a database query may take before being logged in milliseconds.
LogType	The type of the log output.
MaxConcurrentChecksPerPoller	The maximum number of asynchronous checks that can be executed at once by each HTTP agent poller, agent poller or SNMP poller.
MaxHousekeeperDelete	No more than 'MaxHousekeeperDelete' rows (corresponding to [tablename], [field], value) will be deleted per one task in one housekeeping cycle.
NodeAddress	The IP or hostname with optional port to override how the frontend should connect to the server.
PidFile	The name of the PID file.
ProblemHousekeepingFrequency	Determines how often Zabbix will delete problems for deleted triggers.
ProxyConfigFrequency	Determines how often Zabbix server sends configuration data to a Zabbix proxy.
ProxyDataFrequency	Determines how often Zabbix server requests history data from a Zabbix proxy.
ServiceManagerSyncFrequency	Determines how often Zabbix will synchronize the configuration of a service manager.
SMSDevices	A list of comma-delimited modem files allowed to use Zabbix server.
SNMPTrapperFile	The temporary file used for passing data from the SNMP trap daemon to the server.
SocketDir	The directory to store the IPC sockets used by internal Zabbix services.
SourceIP	The source IP address.
SSHKeyLocation	The location of public and private keys for SSH checks and actions.
SSLCertLocation	The location of SSL client certificate files for client authentication.
SSLKeyLocation	The location of SSL private key files for client authentication.
SSLCALocation	Override the location of certificate authority (CA) files for SSL server certificate verification.
StartAgentPollers	The number of pre-forked instances of asynchronous Zabbix agent pollers.
StartAlerters	The number of pre-forked instances of alerters.
StartBrowserPollers	The number of pre-forked instances of browser item pollers.
StartConnectors	The number of pre-forked instances of connector workers.
StartDBSyncers	The number of pre-forked instances of history syncers.
StartDiscoverers	The number of pre-forked instances of discovery workers.
StartEscalators	The number of pre-forked instances of escalators.
StartHistoryPollers	The number of pre-forked instances of history pollers.
StartHTTPAgentPollers	The number of pre-forked instances of asynchronous HTTP agent pollers.
StartHTTTPollers	The number of pre-forked instances of HTTP pollers.
StartIPMIPollers	The number of pre-forked instances of IPMI pollers.
StartJavaPollers	The number of pre-forked instances of Java pollers.
StartLLDProcessors	The number of pre-forked instances of low-level discovery (LLD) workers.
StartODBCPollers	The number of pre-forked instances of ODBC pollers.
StartPingers	The number of pre-forked instances of ICMP pingers.
StartPollersUnreachable	The number of pre-forked instances of pollers for unreachable hosts (including IPMI and Java).
StartPollers	The number of pre-forked instances of pollers.
StartPreprocessors	The number of pre-started instances of preprocessing workers.
StartProxyPollers	The number of pre-forked instances of pollers for passive proxies.
StartReportWriters	The number of pre-forked instances of report writers.
StartSNMPPollers	The number of pre-forked instances of asynchronous SNMP pollers.
StartSNMPTrapper	If set to 1, an SNMP trapper process will be started.
StartTimers	The number of pre-forked instances of timers.
StartTrappers	The number of pre-forked instances of trappers.
StartVMwareCollectors	The number of pre-forked VMware collector instances.
StatsAllowedIP	A list of comma-delimited IP addresses, optionally in CIDR notation, or DNS names of external Zabbix instances. The stats request will be accepted only from the addresses listed here.
Timeout	Specifies how long to wait (in seconds) for establishing connection and exchanging data with Zabbix proxy, agent, web service, and for SNMP checks (except SNMP walk[OID] and get[OID] items) and icmping[*] item.
TLSCAFile	The full pathname of a file containing the top-level CA(s) certificates for peer certificate verification, used for encrypted communications between Zabbix components.

Parameter	Description
TLSCertFile	The full pathname of a file containing the server certificate or certificate chain, used for encrypted communications between Zabbix components.
TLSCipherAll	The GnuTLS priority string or OpenSSL (TLS 1.2) cipher string. Override the default ciphersuite selection criteria for certificate- and PSK-based encryption.
TLSCipherAll13	The cipher string for OpenSSL 1.1.1 or newer in TLS 1.3. Override the default ciphersuite selection criteria for certificate- and PSK-based encryption.
TLSCipherCert	The GnuTLS priority string or OpenSSL (TLS 1.2) cipher string. Override the default ciphersuite selection criteria for certificate-based encryption.
TLSCipherCert13	The cipher string for OpenSSL 1.1.1 or newer in TLS 1.3. Override the default ciphersuite selection criteria for certificate-based encryption.
TLSCipherPSK	The GnuTLS priority string or OpenSSL (TLS 1.2) cipher string. Override the default ciphersuite selection criteria for PSK-based encryption.
TLSCipherPSK13	The cipher string for OpenSSL 1.1.1 or newer in TLS 1.3. Override the default ciphersuite selection criteria for PSK-based encryption.
TLSCRLFile	The full pathname of a file containing revoked certificates. This parameter is used for encrypted communications between Zabbix components.
TLSSignKeyFile	The full pathname of a file containing the server private key, used for encrypted communications between Zabbix components.
TmpDir	The temporary directory.
TrapperTimeout	Specifies timeout in seconds for: <ul style="list-style-type: none"> - retrieval of historical data from Zabbix proxy; - sending configuration data to Zabbix proxy; - global script execution or remote command execution on Zabbix server.
TrendCacheSize	The size of the trend cache.
TrendFunctionCacheSize	The size of the trend function cache.
UnavailableDelay	Determines how often host is checked for availability during the unavailability period.
UnreachableDelay	Determines how often host is checked for availability during the unreachability period.
UnreachablePeriod	Determines after how many seconds of unreachability treats a host as unavailable.
User	Drop privileges to a specific, existing user on the system.
ValueCacheSize	The size of the history value cache.
Vault	Specifies the vault provider.
VaultDBPath	Specifies a location, from where database credentials should be retrieved by keys.
VaultPrefix	Custom prefix for the vault path or query.
VaultTLSCertFile	The name of the SSL certificate file used for client authentication.
VaultTLSKeyFile	The name of the SSL private key file used for client authentication.
VaultToken	The HashiCorp vault authentication token.
VaultURL	The vault server HTTP[S] URL.
VMwareCacheSize	The shared memory size for storing VMware data.
VMwareFrequency	The delay in seconds between data gathering from a single VMware service.
VMwarePerfFrequency	The delay in seconds between performance counter statistics retrieval from a single VMware service.
VMwareTimeout	The maximum number of seconds a vmware collector will wait for a response from VMware service.
WebDriverURL	WebDriver interface HTTP[S] URL.
WebServiceURL	HTTP[S] URL to Zabbix web service in the format <host:port>/report.

All parameters are non-mandatory unless explicitly stated that the parameter is mandatory.

Note that:

- The default values reflect daemon defaults, not the values in the shipped configuration files;
- Values support **environment variables**;
- Zabbix supports configuration files only in UTF-8 encoding without **BOM**;
- Comments starting with "**#**" are only supported in the beginning of the line.

Parameter details

AlertScriptsPath

The location of custom alert scripts (depends on the *datadir* compile-time installation variable).

Default: `/usr/local/share/zabbix/alertscripts`

AllowRoot

Allow the server to run as 'root'. If disabled and the server is started by 'root', the server will try to switch to the 'zabbix' user instead. Has no effect if started under a regular user.

Default: 0
 Values: 0 - do not allow; 1 - allow

AllowSoftwareUpdateCheck

Allow Zabbix UI to receive information about software updates from zabbix.com.

Default: 1
 Values: 0 - do not allow; 1 - allow

AllowUnsupportedDBVersions

Allow the server to work with unsupported database versions.

Default: 0
 Values: 0 - do not allow; 1 - allow

CacheSize

The size of the configuration cache, in bytes. The shared memory size for storing host, item and trigger data.

Default: 32M
 Range: 128K-64G

CacheUpdateFrequency

This parameter determines how often Zabbix will perform the configuration cache update in seconds. See also [runtime control options](#).

Default: 10
 Range: 1-3600

DBHost

The database host name.
With MySQL localhost or empty string results in using a socket. With PostgreSQL only empty string results in attempt to use socket.

Default: localhost

DBName

The database name.

Mandatory: Yes

DBPassword

The database password. Comment this line if no password is used.

DBPort

The database port when not using local socket.

Range: 1024-65535

DBSchema

The database schema name. Used for PostgreSQL.

DBSocket

The path to the MySQL socket file.

DBUser

The database user.

DBTLSConnect

Setting this option to the following values enforces to use a TLS connection to the database:
required - connect using TLS
verify_ca - connect using TLS and verify certificate
verify_full - connect using TLS, verify certificate and verify that database identity specified by DBHost matches its certificate

With MySQL, starting from 5.7.11, and PostgreSQL the following values are supported: *required*, *verify_ca*, *verify_full*.
With MariaDB, starting from version 10.2.6, the *required* and *verify_full* values are supported.
By default not set to any option and the behavior depends on database configuration.

DBTLSCAFile

The full pathname of a file containing the top-level CA(s) certificates for database certificate verification.

Mandatory: no (yes, if DBTLSConnect set to *verify_ca* or *verify_full*)

DBTLSCertFile

The full pathname of a file containing the Zabbix server certificate for authenticating to database.

DBTLSTLSKeyFile

The full pathname of a file containing the private key for authenticating to database.

DBTLSTLSCipher

The list of encryption ciphers that Zabbix server permits for TLS protocols up through TLS v1.2. Supported only for MySQL.

DBTLSTLSCipher13

The list of encryption ciphersuites that Zabbix server permits for the TLS v1.3 protocol. Supported only for MySQL, starting from version 8.0.16.

DebugLevel

Specify the debug level:
0 - basic information about starting and stopping of Zabbix processes
1 - critical information;
2 - error information;
3 - warnings;
4 - for debugging (produces lots of information);
5 - extended debugging (produces even more information).
See also [runtime control](#) options.

Default: 3
 Range: 0-5

EnableGlobalScripts

Enable global scripts on Zabbix server.
 Note: Global script execution is enabled by default. However, for new installations starting with Zabbix 7.0, EnableGlobalScripts is explicitly set to 0 (disabled).

Default: 1
 Values: 0 - disable; 1 - enable

ExportDir

The directory for [real-time export](#) of events, history and trends in newline-delimited JSON format. If set, enables the real-time export.

ExportFileSize

The maximum size per export file in bytes. Used for rotation if ExportDir is set.

Default: 1G
 Range: 1M-1G

ExportType

The list of comma-delimited entity types (events, history, trends) for [real-time export](#) (all types by default). Valid only if ExportDir is set.
 Note that if ExportType is specified, but ExportDir is not, then this is a configuration error and the server will not start.

Example for history and trends export:

```
ExportType=history,trends
```

Example for event export only:

```
ExportType=events
```

ExternalScripts

The location of external scripts (depends on the `datadir` compile-time installation variable).

Default: `/usr/local/share/zabbix/externalscripts`

Fping6Location

The location of `fping6`. Make sure that the `fping6` binary has root ownership and the SUID flag set. Make empty ("`Fping6Location=`") if your `fping` utility is capable to process IPv6 addresses.

Default: `/usr/sbin/fping6`

FpingLocation

The location of `fping`. Make sure that the `fping` binary has root ownership and the SUID flag set.

Default: `/usr/sbin/fping`

HANodeName

The high availability cluster node name. When empty the server is working in standalone mode and a node with empty name is created.

HistoryCacheSize

The size of the history cache, in bytes. The shared memory size for storing history data.

Default: 16M
 Range: 128K-2G

HistoryIndexCacheSize

The size of the history index cache, in bytes. The shared memory size for indexing the history data stored in history cache. The index cache size needs roughly 100 bytes to cache one item.

Default: 4M
 Range: 128K-2G

HistoryStorageDateIndex

Enable preprocessing of history values in history storage to store values in different indices based on date.

Default: 0
 Values: 0 - disable; 1 - enable

HistoryStorageURL

The history storage HTTP[S] URL. This parameter is used for [Elasticsearch](#) setup.

HistoryStorageTypes

A comma-separated list of value types to be sent to the history storage. This parameter is used for [Elasticsearch](#) setup.

Default: uint,dbl,str,log,text

HousekeepingFrequency

This parameter determines how often Zabbix will perform the housekeeping procedure in hours. Housekeeping is removing outdated information from the database.
Note: To prevent housekeeper from being overloaded (for example, when history and trend periods are greatly reduced), no more than 4 times HousekeepingFrequency hours of outdated information are deleted in one housekeeping cycle, for each item. Thus, if HousekeepingFrequency is 1, no more than 4 hours of outdated information (starting from the oldest entry) will be deleted per cycle.
Note: To lower load on server startup housekeeping is postponed for 30 minutes after server start. Thus, if HousekeepingFrequency is 1, the very first housekeeping procedure after server start will run after 30 minutes, and will repeat with one hour delay thereafter.
It is possible to disable automatic housekeeping by setting HousekeepingFrequency to 0. In this case the housekeeping procedure can only be started by *housekeeper_execute* runtime control option and the period of outdated information deleted in one housekeeping cycle is 4 times the period since the last housekeeping cycle, but not less than 4 hours and not greater than 4 days.
See also [runtime control](#) options.

Default: 1
 Range: 0-24

Include

You may include individual files or all files in a directory in the configuration file. To only include relevant files in the specified directory, the asterisk wildcard character is supported for pattern matching. See [special notes](#) about limitations.

Example:

```
Include=/absolute/path/to/config/files/*.conf
```

JavaGateway

The IP address (or hostname) of Zabbix Java gateway. Only required if Java pollers are started.

JavaGatewayPort

The port that Zabbix Java gateway listens on.

Default: 10052
 Range: 1024-32767

ListenBacklog

The maximum number of pending connections in the TCP queue.
The default value is a hard-coded constant, which depends on the system.
The maximum supported value depends on the system, too high values may be silently truncated to the 'implementation-specified maximum'.

Default: SOMAXCONN
 Range: 0 - INT_MAX

ListenIP

A list of comma-delimited IP addresses that the trapper should listen on.
Trapper will listen on all network interfaces if this parameter is missing.

Default: 0.0.0.0

ListenPort

The listen port for trapper.

Default: 10051
 Range: 1024-32767

LoadModule

The module to load at server startup. Modules are used to extend the functionality of the server. The module must be located in the directory specified by `LoadModulePath` or the path must precede the module name. If the preceding path is absolute (starts with '/') then `LoadModulePath` is ignored. Formats: `LoadModule=<module.so>` `LoadModule=<path/module.so>` `LoadModule=</ab` is allowed to include multiple `LoadModule` parameters.

LoadModulePath

The full path to the location of server modules. The default depends on compilation options.

LogFile

The name of the log file.

Mandatory: Yes, if `LogType` is set to *file*; otherwise no

LogFileSize

The maximum size of the log file in MB. `0` - disable automatic log rotation. *Note*: If the log file size limit is reached and file rotation fails, for whatever reason, the existing log file is truncated and started anew.

Default: 1 Range: 0-1024 Mandatory: Yes, if `LogType` is set to *file*; otherwise no

LogSlowQueries

Determines how long a database query may take before being logged in milliseconds. `0` - don't log slow queries. This option becomes enabled starting with `DebugLevel=3`.

Default: 0 Range: 0-3600000

LogType

The type of the log output: *file* - write log to file specified by `LogFile` parameter; *system* - write log to syslog; *console* - write log to standard output.

Default: *file*

MaxConcurrentChecksPerPoller

The maximum number of asynchronous checks that can be executed at once by each HTTP agent poller, agent poller or SNMP poller. See [StartHTTPAgentPollers](#), [StartAgentPollers](#), and [StartSNMPPollers](#).

Default: 1000 Range: 1-1000

MaxHousekeeperDelete

No more than 'MaxHousekeeperDelete' rows (corresponding to [tablename], [field], [value]) will be deleted per one task in one housekeeping cycle. If set to 0 then no limit is used at all. In this case you must know what you are doing, so as not to **overload the database!** This parameter applies only to deleting history and trends of already deleted items.

Default: 5000 Range: 0-1000000

NodeAddress

IP or hostname with optional port to override how the frontend should connect to the server. Format: `<address>[:<port>]` If IP or hostname is not set, the value of `ListenIP` will be used. If `ListenIP` is not set, the value `localhost` will be used. If port is not set, the value of `ListenPort` will be used. If `ListenPort` is not set, the value `10051` will be used. This option can be overridden by the address specified in the frontend configuration. See also: [HANodeName](#) parameter; [Enabling high availability](#).

Default: 'localhost:10051'

PidFile

Name of the PID file.

Default: `/tmp/zabbix_server.pid`

ProblemHousekeepingFrequency

Determines how often Zabbix will delete problems for deleted triggers in seconds.

Default: 60 Range: 1-3600

ProxyConfigFrequency

Determines how often Zabbix server sends configuration data to a Zabbix proxy in seconds. Used only for proxies in a passive mode.

Default: 10
 Range: 1-604800

ProxyDataFrequency

Determines how often Zabbix server requests history data from a Zabbix proxy in seconds. Used only for proxies in the passive mode.

Default: 1
 Range: 1-3600

ServiceManagerSyncFrequency

Determines how often Zabbix will synchronize the configuration of a service manager in seconds.

Default: 60
 Range: 1-3600

SMSDevices

A list of comma-delimited modem files allowed to use Zabbix server.
SMS sending is not possible if this parameter is not set.

Example:

```
SMSDevices=/dev/ttyUSB0,/dev/ttyUSB1
```

SNMPTrapperFile

Temporary file used for passing data from the SNMP trap daemon to the server.
Must be the same as in zabbix_trap_receiver.pl or SNMPTT configuration file.

Default: /tmp/zabbix_traps.tmp

SocketDir

Directory to store IPC sockets used by internal Zabbix services.

Default: /tmp

SourceIP

Source IP address for:
- outgoing connections to Zabbix proxy and Zabbix agent;
- agentless connections (VMware, SSH, JMX, SNMP, Telnet and simple checks);
- HTTP agent connections;
- script item JavaScript HTTP requests;
- preprocessing JavaScript HTTP requests;
- sending notification emails (connections to SMTP server);
- webhook notifications (JavaScript HTTP connections);
- connections to the Vault

SSHKeyLocation

Location of public and private keys for SSH checks and actions.

SSLCertLocation

Location of SSL client certificate files for client authentication.
This parameter is used in web monitoring only.

SSLKeyLocation

Location of SSL private key files for client authentication.
This parameter is used in web monitoring only.

SSLCALocation

Override the location of certificate authority (CA) files for SSL server certificate verification. If not set, system-wide directory will be used.
Note that the value of this parameter will be set as libcurl option CURLOPT_CAPATH. For libcurl versions before 7.42.0, this only has effect if libcurl was compiled to use OpenSSL. For more information see [CURL web page](#).
This parameter is used in web monitoring and in SMTP authentication.

StartAgentPollers

The number of pre-forked instances of Zabbix agent **pollers**. See **MaxConcurrentChecksPerPoller**.

Default: 1
 Range: 0-1000

StartAlerters

The number of pre-forked instances of **alerters**.

Default: 3
 Range: 1-100

StartBrowserPollers

The number of pre-forked instances of browser item **pollers**.

Default: 1
 Range: 0-1000

StartConnectors

The number of pre-forked instances of **connector workers**. The connector manager process is started automatically when a connector worker is started.

Default: 0
 Range: 0-1000

StartDBSyncers

The number of pre-forked instances of **history syncers**.
Note: Be careful when changing this value, increasing it may do more harm than good. Roughly, the default value should be enough to handle up to 4000 NVPS.

Default: 4
 Range: 1-100

StartDiscoverers

The number of pre-forked instances of **discovery workers**¹.

Default: 5
 Range: 0-1000

StartEscalators

The number of pre-forked instances of **escalators**.

Default: 1
 Range: 1-100

StartHistoryPollers

The number of pre-forked instances of **history pollers**.
Only required for calculated checks.

Default: 5
 Range: 0-1000

StartHTTPAgentPollers

The number of pre-forked instances of HTTP agent **pollers**. See **MaxConcurrentChecksPerPoller**.

Default: 1
 Range: 0-1000

StartHTTTPollers

The number of pre-forked instances of **HTTP pollers**¹.

Default: 1
 Range: 0-1000

StartIPMIPollers

The number of pre-forked instances of **IPMI pollers**.

Default: 0
 Range: 0-1000

StartJavaPollers

The number of pre-forked instances of **Java pollers**¹.

Default: 0
 Range: 0-1000

StartLLDProcessors

The number of pre-forked instances of low-level discovery (LLD) **workers**¹.
The LLD manager process is automatically started when an LLD worker is started.

Default: 2
 Range: 0-100

StartODBCPollers

The number of pre-forked instances of **ODBC pollers**¹.

Default: 1
 Range: 0-1000

StartPingers

The number of pre-forked instances of **ICMP pingers**¹.

Default: 1
 Range: 0-1000

StartPollersUnreachable

The number of pre-forked instances of **pollers for unreachable hosts** (including IPMI and Java)¹.
At least one poller for unreachable hosts must be running if regular, IPMI or Java pollers are started.

Default: 1
 Range: 0-1000

StartPollers

The number of pre-forked instances of **pollers**¹.

Default: 5
 Range: 0-1000

StartPreprocessors

The number of pre-started instances of preprocessing **worker**¹ threads should be set to no less than the available CPU core count. More workers should be set if preprocessing is not CPU-bound and has lots of network requests.

Default: 16
 Range: 1-1000

StartProxyPollers

The number of pre-forked instances of **pollers for passive proxies**¹.

Default: 1
 Range: 0-250

StartReportWriters

The number of pre-forked instances of **report writers**.
If set to 0, scheduled report generation is disabled.
The report manager process is automatically started when a report writer is started.

Default: 0
 Range: 0-100

StartSNMPPollers

The number of pre-forked instances of SNMP **pollers**. See **MaxConcurrentChecksPerPoller**.

Default: 1
 Range: 0-1000

StartSNMPTrapper

If set to 1, an **SNMP trapper** process will be started.

Default: 0
 Range: 0-1

StartTimers

The number of pre-forked instances of **timers**.
Timers process maintenance periods.

Default: 1
 Range: 1-1000

StartTrappers

The number of pre-forked instances of **trappers**¹.
Trappers accept incoming connections from Zabbix sender, active agents and active proxies.

Default: 5
 Range: 1-1000

StartVMwareCollectors

The number of pre-forked **VMware collector** instances.

Default: 0
 Range: 0-250

StatsAllowedIP

A list of comma delimited IP addresses, optionally in CIDR notation, or DNS names of external Zabbix instances. Stats request will be accepted only from the addresses listed here. If this parameter is not set no stats requests will be accepted.
If IPv6 support is enabled then '127.0.0.1', '::127.0.0.1', '::ffff:127.0.0.1' are treated equally and '::/0' will allow any IPv4 or IPv6 address. '0.0.0.0/0' can be used to allow any IPv4 address.

Example:

```
StatsAllowedIP=127.0.0.1,192.168.1.0/24,::1,2001:db8::/32,zabbix.example.com
```

Timeout

Specifies how long to wait (in seconds) for establishing connection and exchanging data with Zabbix proxy, agent, web service, and for SNMP checks (except SNMP walk[OID] and get [OID] items) and icmping[*] item.
 This parameter defines the duration for various communication operations:

- remote command execution on the Zabbix agent;
- SSH / Telnet command execution;
- requests to the Zabbix Web Service;
- communication timeout for mediatype test request and history.push method;
- rescheduling of items when IPMI interface becomes unavailable;

- sending response to Zabbix proxy when failing to exchange data due to rights or encryption issues;
- ICMP pinger;
- deadline for IPC asynchronous sockets and runtime control options;
- JMX connections;
- fetching statistics from a remote Zabbix proxy or server;
- sending responses to the Zabbix frontend;
- asynchronous poller DNS requests;
- response for active check heartbeat;
- retrieval of Zabbix agent data (values) from active agents;
- retrieval of data from Zabbix sender;
- response when trapper fails to process a request;
- sending active check list to Zabbix agent.

Default: 3
 Range: 1-30

TLSCAFile

The full pathname of a file containing the top-level CA(s) certificates for peer certificate verification, used for encrypted communications between Zabbix components.

TLSCertFile

The full pathname of a file containing the server certificate or certificate chain, used for encrypted communications between Zabbix components.

TLSCipherAll

The GnuTLS priority string or OpenSSL (TLS 1.2) cipher string. Override the default ciphersuite selection criteria for certificate- and PSK-based encryption.

Example:

```
TLS_AES_256_GCM_SHA384:TLS_CHACHA20_POLY1305_SHA256:TLS_AES_128_GCM_SHA256
```

TLSCipherAll13

The cipher string for OpenSSL 1.1.1 or newer in TLS 1.3. Override the default ciphersuite selection criteria for certificate- and PSK-based encryption.

Example for GnuTLS:

```
NONE:+VERS-TLS1.2:+ECDHE-RSA:+RSA:+ECDHE-PSK:+PSK:+AES-128-GCM:+AES-128-CBC:+AEAD:+SHA256:+SHA1:+CURVE-ALL
```

Example for OpenSSL:

```
EECDH+aRSA+AES128:RSA+aRSA+AES128:kECDHEPSK+AES128:kPSK+AES128
```

TLSCipherCert

The GnuTLS priority string or OpenSSL (TLS 1.2) cipher string. Override the default ciphersuite selection criteria for certificate-based encryption.

Example for GnuTLS:

```
NONE:+VERS-TLS1.2:+ECDHE-RSA:+RSA:+AES-128-GCM:+AES-128-CBC:+AEAD:+SHA256:+SHA1:+CURVE-ALL:+COMP-NULL:+SIG
```

Example for OpenSSL:

```
EECDH+aRSA+AES128:RSA+aRSA+AES128
```

TLSCipherCert13

The cipher string for OpenSSL 1.1.1 or newer in TLS 1.3. Override the default ciphersuite selection criteria for certificate-based encryption.

TLSCipherPSK

The GnuTLS priority string or OpenSSL (TLS 1.2) cipher string. Override the default ciphersuite selection criteria for PSK-based encryption.

Example for GnuTLS:

NONE:+VERS-TLS1.2:+ECDHE-PSK:+PSK:+AES-128-GCM:+AES-128-CBC:+AEAD:+SHA256:+SHA1:+CURVE-ALL:+COMP-NULL:+SIG

Example for OpenSSL:

kECDHEPSK+AES128:kPSK+AES128

TLSCipherPSK13

The cipher string for OpenSSL 1.1.1 or newer in TLS 1.3. Override the default ciphersuite selection criteria for PSK-based encryption.

Example:

TLS_CHACHA20_POLY1305_SHA256:TLS_AES_128_GCM_SHA256

TLSCRLFile

The full pathname of a file containing revoked certificates. This parameter is used for encrypted communications between Zabbix components.

TLSKeyFile

The full pathname of a file containing the server private key, used for encrypted communications between Zabbix components.

TmpDir

The temporary directory.

Default: /tmp

TrapperTimeout

Specifies timeout in seconds for:

- retrieval of historical data from Zabbix proxy;
- sending configuration data to Zabbix proxy;
- global script execution or remote command execution on Zabbix server.

Default: 300
 Range: 1-300

TrendCacheSize

The size of the trend cache, in bytes.
The shared memory size for storing trends data.

Default: 4M
 Range: 128K-2G

TrendFunctionCacheSize

The size of the trend function cache, in bytes.
The shared memory size for caching calculated trend function data.

Default: 4M
 Range: 128K-2G

UnavailableDelay

Determines how often host is checked for availability during the **unavailability** period in seconds.

Default: 60
 Range: 1-3600

UnreachableDelay

Determines how often host is checked for availability during the **unreachability** period in seconds.

Default: 15
 Range: 1-3600

UnreachablePeriod

Determines after how many seconds of **unreachability** treats a host as unavailable.

Default: 45
 Range: 1-3600

User

Drop privileges to a specific, existing user on the system.
Only has effect if run as 'root' and AllowRoot is disabled.

Default: zabbix

ValueCacheSize

The size of the history value cache, in bytes.
The shared memory size for caching item history data requests.
Setting to 0 disables the value cache (not recommended).
When the value cache runs out of the shared memory a warning message is written to the server log every 5 minutes.

Default: 8M
 Range: 0,128K-64G

Vault

Specifies the vault provider:
HashiCorp - HashiCorp KV Secrets Engine version 2
CyberArk - CyberArk Central Credential Provider
Must match the vault provider set in the frontend.

Default: HashiCorp

VaultDBPath

Specifies a location, from where database credentials should be retrieved by keys. Depending on the Vault, can be vault path or query.
 The keys used for HashiCorp are 'password' and 'username'.

Example:

```
secret/zabbix/database
```

The keys used for CyberArk are 'Content' and 'UserName'.

Example:

```
AppID=zabbix_server&Query=Safe=passwordSafe;Object=zabbix_proxy_database
```

This option can only be used if DBUser and DBPassword are not specified.

VaultPrefix

A custom prefix for the vault path or query, depending on the vault; if not specified, the most suitable defaults will be used.

VaultTLSCertFile

The name of the SSL certificate file used for client authentication
 The certificate file must be in PEM1 format.
 If the certificate file contains also the private key, leave the SSL key file field empty.
 The directory containing this file is specified by the configuration parameter SSLCertLocation.
This option can be omitted but is recommended for CyberArkCCP vault.

VaultTLSKeyFile

The name of the SSL private key file used for client authentication.
 The private key file must be in PEM1 format.
 The directory containing this file is specified by the configuration parameter SSLKeyLocation.
This option can be omitted but is recommended for CyberArkCCP vault.

VaultToken

The HashiCorp Vault authentication token that should have been generated exclusively for Zabbix server with read-only permission to the paths specified in **Vault macros** and read-only permission to the path specified in the optional VaultDBPath configuration parameter.
It is an error if VaultToken and VAULT_TOKEN environment variable are defined at the same time.

Mandatory: Yes, if Vault is set to *HashiCorp*; otherwise no

VaultURL

The vault server HTTP[S] URL. The system-wide CA certificates directory will be used if SSLCALocation is not specified.

Default: https://127.0.0.1:8200

VMwareCacheSize

The shared memory size for storing VMware data.
A VMware internal check zabbix[vmware,buffer,...] can be used to monitor the VMware cache usage (see **Internal checks**).
Note that shared memory is not allocated if there are no vmware collector instances configured to start.

Default: 8M
 Range: 256K-2G

VMwareFrequency

The delay in seconds between data gathering from a single VMware service.
This delay should be set to the least update interval of any VMware monitoring item.

Default: 60
 Range: 10-86400

VMwarePerfFrequency

The delay in seconds between performance counter statistics retrieval from a single VMware service. This delay should be set to the least update interval of any VMware monitoring **item** that uses VMware performance counters.

Default: 60
 Range: 10-86400

VMwareTimeout

The maximum number of seconds a vmware collector will wait for a response from VMware service (vCenter or ESX hypervisor).

Default: 10
 Range: 1-300

WebServiceURL

The HTTP[S] URL to Zabbix web service in the format <host:port>/report.

Example:

WebServiceURL=http://localhost:10053/report

WebDriverURL

WebDriver interface HTTP[S] URL.

Example (used with Selenium WebDriver standalone server):

WebDriverURL=http://localhost:4444

Footnotes

¹ Note that too many data gathering processes (pollers, unreachable pollers, ODBC pollers, HTTP pollers, Java pollers, pingers, trappers, proxypollers) together with IPMI manager, SNMP trapper, preprocessing workers, and discovery workers can exhaust the per-process file descriptor limit for the preprocessing manager.

Warning:

Exhausting the file descriptor limit will cause Zabbix server to stop, typically shortly after startup but sometimes taking longer. To avoid such issues, review the [Zabbix server configuration file](#) to optimize the number of concurrent checks and processes. Additionally, if necessary, ensure that the file descriptor limit is set sufficiently high by checking and adjusting system limits.

² When a lot of items are deleted it increases the load to the database, because the housekeeper will need to remove all the history data that these items had. For example, if we only have to remove 1 item prototype, but this prototype is linked to 50 hosts and for every host the prototype is expanded to 100 real items, 5000 items in total have to be removed (1*50*100). If 500 is set for MaxHousekeeperDelete (MaxHousekeeperDelete=500), the housekeeper process will have to remove up to 2500000 values (5000*500) for the deleted items from history and trends tables in one cycle.

2 Zabbix proxy

Overview

The parameters supported by the Zabbix proxy configuration file (zabbix_proxy.conf) are listed in this section.

The parameters are listed without additional information. Click on the parameter to see the full details.

Parameter	Description
AllowRoot	Allow the proxy to run as 'root'.
AllowUnsupportedDBVersions	Allow the proxy to work with unsupported database versions.
CacheSize	The size of the configuration cache.
ConfigFrequency	This parameter is deprecated (use ProxyConfigFrequency instead). How often the proxy retrieves configuration data from Zabbix server in seconds.
DataSenderFrequency	The proxy will send collected data to the server every N seconds.
DBHost	The database host name.
DBName	The database name or path to the database file for SQLite3.
DBPassword	The database password.
DBPort	The database port when not using local socket.
DBSchema	The database schema name. Used for PostgreSQL.
DBSocket	The path to the MySQL socket file.
DBUser	The database user.
DBTLSConnect	Setting this option to the specified value enforces to use a TLS connection to the database.
DBTLSCAFile	The full pathname of a file containing the top-level CA(s) certificates for database certificate verification.
DBTLSCertFile	The full pathname of a file containing the Zabbix proxy certificate for authenticating to database.
DBTLSKeyFile	The full pathname of a file containing the private key for authenticating to database.

Parameter	Description
DBTLSCipher	The list of encryption ciphers that Zabbix proxy permits for TLS protocols up through TLS v1.2. Supported only for MySQL.
DBTLSCipher13	The list of encryption ciphersuites that Zabbix proxy permits for the TLS v1.3 protocol. Supported only for MySQL, starting from version 8.0.16.
DebugLevel	The debug level.
EnableRemoteCommands	Whether remote commands from Zabbix server are allowed.
ExternalScripts	The location of external scripts.
Fping6Location	The location of fping6.
FpingLocation	The location of fping.
HistoryCacheSize	The size of the history cache.
HistoryIndexCacheSize	The size of the history index cache.
Hostname	A unique, case sensitive proxy name.
Hostnameltem	The item used for setting Hostname if it is undefined.
HousekeepingFrequency	How often Zabbix will perform the housekeeping procedure in hours.
Include	You may include individual files or all files in a directory in the configuration file.
JavaGateway	The IP address (or hostname) of Zabbix Java gateway.
JavaGatewayPort	The port that Zabbix Java gateway listens on.
ListenBacklog	The maximum number of pending connections in the TCP queue.
ListenIP	A list of comma-delimited IP addresses that the trapper should listen on.
ListenPort	The listen port for trapper.
LoadModule	The module to load at proxy startup.
LoadModulePath	The full path to the location of proxy modules.
LogFile	The name of the log file.
LogFileSize	The maximum size of the log file.
LogRemoteCommands	Enable logging of executed shell commands as warnings.
LogSlowQueries	How long a database query may take before being logged.
LogType	The type of the log output.
MaxConcurrentChecksPerPoller	The maximum number of asynchronous checks that can be executed at once by each HTTP agent poller, agent poller or SNMP poller.
PidFile	The name of the PID file.
ProxyBufferMode	Specifies history, discovery and autoregistration data storage mechanism (disk/memory/hybrid).
ProxyConfigFrequency	How often the proxy retrieves configuration data from Zabbix server in seconds.
ProxyLocalBuffer	The proxy will keep data locally for N hours, even if the data have already been synced with the server.
ProxyMemoryBufferAge	The maximum age of data in proxy memory buffer in seconds.
ProxyMemoryBufferSize	The size of shared memory cache for collected history, discovery and auto registration data.
ProxyMode	The proxy operating mode (active/passive).
ProxyOfflineBuffer	The proxy will keep data for N hours in case of no connectivity with Zabbix server.
Server	If ProxyMode is set to active mode: Zabbix server IP address or DNS name (address:port) or cluster (address:port;address2:port) to get configuration data from and send data to. If ProxyMode is set to passive mode: List of comma delimited IP addresses, optionally in CIDR notation, or DNS names of Zabbix server.
SNMPTrapperFile	The temporary file used for passing data from the SNMP trap daemon to the proxy.
SocketDir	The directory to store the IPC sockets used by internal Zabbix services.
SourceIP	The source IP address.
SSHKeyLocation	The location of public and private keys for SSH checks and actions.
SSLCertLocation	The location of SSL client certificate files for client authentication.
SSLKeyLocation	The location of SSL private key files for client authentication.
SSLCALocation	Override the location of certificate authority (CA) files for SSL server certificate verification.
StartAgentPollers	The number of pre-forked instances of asynchronous Zabbix agent pollers.
StartBrowserPollers	The number of pre-forked instances of browser item pollers.
StartDBSyncers	The number of pre-forked instances of history syncers.
StartDiscoverers	The number of pre-forked instances of discovery workers.
StartHTTPAgentPollers	The number of pre-forked instances of asynchronous HTTP agent pollers.
StartHTTTPollers	The number of pre-forked instances of HTTP pollers.
StartIPMIPollers	The number of pre-forked instances of IPMI pollers.
StartJavaPollers	The number of pre-forked instances of Java pollers.
StartODBCPollers	The number of pre-forked instances of ODBC pollers.
StartPingers	The number of pre-forked instances of ICMP pingers.
StartPollersUnreachable	The number of pre-forked instances of pollers for unreachable hosts (including IPMI and Java).
StartPollers	The number of pre-forked instances of pollers.

Parameter	Description
StartPreprocessors	The number of pre-started instances of preprocessing workers.
StartSNMPPollers	The number of pre-forked instances of asynchronous SNMP pollers.
StartSNMPTrapper	If set to 1, an SNMP trapper process will be started.
StartTrappers	The number of pre-forked instances of trappers.
StartVMwareCollectors	The number of pre-forked VMware collector instances.
StatsAllowedIP	A list of comma-delimited IP addresses, optionally in CIDR notation, or DNS names of external Zabbix instances. The stats request will be accepted only from the addresses listed here.
Timeout	Specifies how long to wait (in seconds) for establishing connection and exchanging data with Zabbix proxy, agent, web service, and for SNMP checks (except SNMP walk [OID] and get [OID] items) and icmping [*] item.
TLSAccept	What incoming connections to accept from Zabbix server.
TLSCAFile	The full pathname of a file containing the top-level CA(s) certificates for peer certificate verification, used for encrypted communications between Zabbix components.
TLSCertFile	The full pathname of a file containing the server certificate or certificate chain, used for encrypted communications between Zabbix components.
TLSCipherAll	The GnuTLS priority string or OpenSSL (TLS 1.2) cipher string. Override the default ciphersuite selection criteria for certificate- and PSK-based encryption.
TLSCipherAll13	The cipher string for OpenSSL 1.1.1 or newer in TLS 1.3. Override the default ciphersuite selection criteria for certificate- and PSK-based encryption.
TLSCipherCert	The GnuTLS priority string or OpenSSL (TLS 1.2) cipher string. Override the default ciphersuite selection criteria for certificate-based encryption.
TLSCipherCert13	The cipher string for OpenSSL 1.1.1 or newer in TLS 1.3. Override the default ciphersuite selection criteria for certificate-based encryption.
TLSCipherPSK	The GnuTLS priority string or OpenSSL (TLS 1.2) cipher string. Override the default ciphersuite selection criteria for PSK-based encryption.
TLSCipherPSK13	The cipher string for OpenSSL 1.1.1 or newer in TLS 1.3. Override the default ciphersuite selection criteria for PSK-based encryption.
TLSConnect	How the proxy should connect to Zabbix server.
TLS SRLFile	The full pathname of a file containing revoked certificates. This parameter is used for encrypted communications between Zabbix components.
TLSKeyFile	The full pathname of a file containing the proxy private key, used for encrypted communications between Zabbix components.
TLSPSKFile	The full pathname of a file containing the proxy pre-shared key, used for encrypted communications with Zabbix server.
TLSPSKIdentity	The pre-shared key identity string, used for encrypted communications with Zabbix server.
TLS ServerCertIssuer	The allowed server certificate issuer.
TLS ServerCertSubject	The allowed server certificate subject.
TmpDir	The temporary directory.
TrapperTimeout	Specifies timeout in seconds for: <ul style="list-style-type: none"> - retrieval of configuration data from the Zabbix server; - global script execution or remote command execution.
UnavailableDelay	How often a host is checked for availability during the unavailability period.
UnreachableDelay	How often a host is checked for availability during the unreachability period.
UnreachablePeriod	After how many seconds of unreachability treat the host as unavailable.
User	Drop privileges to a specific, existing user on the system.
Vault	The vault provider.
VaultDBPath	The location, from where database credentials should be retrieved by keys.
VaultPrefix	Custom prefix for the vault path or query.
VaultTLSCertFile	The name of the SSL certificate file used for client authentication.
VaultTLSKeyFile	The name of the SSL private key file used for client authentication.
VaultToken	The HashiCorp vault authentication token.
VaultURL	The vault server HTTP[S] URL.
VMwareCacheSize	The shared memory size for storing VMware data.
VMwareFrequency	The delay in seconds between data gathering from a single VMware service.
VMwarePerfFrequency	The delay in seconds between performance counter statistics retrieval from a single VMware service.
VMwareTimeout	The maximum number of seconds a vmware collector will wait for a response from VMware service.
WebDriverURL	WebDriver interface HTTP[S] URL.

All parameters are non-mandatory unless explicitly stated that the parameter is mandatory.

Note that:

- The default values reflect daemon defaults, not the values in the shipped configuration files;
- Values support **environment variables**;
- Zabbix supports configuration files only in UTF-8 encoding without **BOM**;
- Comments starting with “#” are only supported in the beginning of the line.

Parameter details

AllowRoot

Allow the proxy to run as 'root'. If disabled and the proxy is started by 'root', the proxy will try to switch to the 'zabbix' user instead. Has no effect if started under a regular user.

Default: 0
 Values: 0 - do not allow; 1 - allow

AllowUnsupportedDBVersions

Allow the proxy to work with unsupported database versions.

Default: 0
 Values: 0 - do not allow; 1 - allow

CacheSize

The size of the configuration cache, in bytes. The shared memory size for storing host and item data.

Default: 32M
 Range: 128K-64G

ConfigFrequency

This parameter is **deprecated** (use ProxyConfigFrequency instead).
How often the proxy retrieves configuration data from Zabbix server in seconds.
Active proxy parameter. Ignored for passive proxies (see ProxyMode parameter).

Default: 3600
 Range: 1-604800

DataSenderFrequency

The proxy will send collected data to the server every N seconds. Note that an active proxy will still poll Zabbix server every second for remote command tasks.
Active proxy parameter. Ignored for passive proxies (see ProxyMode parameter).

Default: 1
 Range: 1-3600

DBHost

The database host name.
With MySQL localhost or empty string results in using a socket. With PostgreSQL only empty string results in attempt to use socket.

Default: localhost

DBName

The database name or path to the database file for SQLite3 (the multi-process architecture of Zabbix does not allow to use **in-memory database**, e.g. :memory:, file::memory:?cache=shared or file::memdb1?mode=memory&cache=shared).
Warning: Do not attempt to use the same database the Zabbix server is using.

Mandatory: Yes

DBPassword

The database password. Comment this line if no password is used. Ignored for SQLite.

DBPort

The database port when not using local socket. Ignored for SQLite.

Range: 1024-65535

DBSchema

The database schema name. Used for PostgreSQL.

DBSocket

The path to the MySQL socket file.
The database port when not using local socket. Ignored for SQLite.

Default: 3306

DBUser

The database user. Ignored for SQLite.

DBTLSConnect

Setting this option enforces to use TLS connection to the database: `required` - connect using TLS `verify_ca` - connect using TLS and verify certificate `verify_full` - connect using TLS, verify certificate and verify that database identity specified by DBHost matches its certificate. On MySQL starting from 5.7.11 and PostgreSQL the following values are supported: "required", "verify", "verify_full". On MariaDB starting from version 10.2.6 "required" and "verify_full" values are supported. By default not set to any option and the behavior depends on database configuration.

DBTLSCAFile

The full pathname of a file containing the top-level CA(s) certificates for database certificate verification.

Mandatory: no (yes, if DBTLSConnect set to `verify_ca` or `verify_full`)

DBTLSCertFile

The full pathname of a file containing the Zabbix proxy certificate for authenticating to database.

DBTLSKeyFile

The full pathname of a file containing the private key for authenticating to the database.

DBTLSCipher

The list of encryption ciphers that Zabbix proxy permits for TLS protocols up through TLS v1.2. Supported only for MySQL.

DBTLSCipher13

The list of encryption ciphersuites that Zabbix proxy permits for the TLS v1.3 protocol. Supported only for MySQL, starting from version 8.0.16.

DebugLevel

Specify the debug level: `0` - basic information about starting and stopping of Zabbix processes `1` - critical information; `2` - error information; `3` - warnings; `4` - for debugging (produces lots of information); `5` - extended debugging (produces even more information).

Default: 3 `Range: 0-5`

EnableRemoteCommands

Whether remote commands from Zabbix server are allowed.

Default: 0 `Values: 0 - not allowed; 1 - allowed`

ExternalScripts

The location of external scripts (depends on the `datadir` compile-time installation variable).

Default: `/usr/local/share/zabbix/externalscripts`

Fping6Location

The location of `fping6`. Make sure that the `fping6` binary has root ownership and the SUID flag set. Make empty ("`Fping6Location=`") if your `fping` utility is capable to process IPv6 addresses.

Default: `/usr/sbin/fping6`

FpingLocation

The location of `fping`. Make sure that the `fping` binary has root ownership and the SUID flag set.

Default: `/usr/sbin/fping`

HistoryCacheSize

The size of the history cache, in bytes. The shared memory size for storing history data.

Default: 16M `Range: 128K-2G`

HistoryIndexCacheSize

The size of the history index cache, in bytes. The shared memory size for indexing the history data stored in history cache. The index cache size needs roughly 100 bytes to cache one item.

Default: 4M `Range: 128K-2G`

Hostname

A unique, case sensitive proxy name. Make sure the proxy name is known to the server.
Allowed characters: alphanumeric, '.', '_', '-' and '-'. Maximum length: 128

Default: Set by HostnameItem

HostnameItem

The item used for setting Hostname if it is undefined (this will be run on the proxy similarly as on an agent). Ignored if Hostname is set.
Does not support UserParameters, performance counters or aliases, but does support system.run[[]].

Default: system.hostname

HousekeepingFrequency

How often Zabbix will perform housekeeping procedure (in hours). Housekeeping is removing outdated information from the database.
Note: To lower load on proxy startup housekeeping is postponed for 30 minutes after proxy start. Thus, if HousekeepingFrequency is 1, the very first housekeeping procedure after proxy start will run after 30 minutes, and will repeat every hour thereafter.
It is possible to disable automatic housekeeping by setting HousekeepingFrequency to 0. In this case the housekeeping procedure can only be started by *housekeeper_execute* runtime control option.

Default: 1
 Range: 0-24

Include

You may include individual files or all files in a directory in the configuration file.
To only include relevant files in the specified directory, the asterisk wildcard character is supported for pattern matching.
See [special notes](#) about limitations.

Example:

```
Include=/absolute/path/to/config/files/*.conf
```

JavaGateway

The IP address (or hostname) of Zabbix Java gateway. Only required if Java pollers are started.

JavaGatewayPort

The port that Zabbix Java gateway listens on.

Default: 10052
 Range: 1024-32767

ListenBacklog

The maximum number of pending connections in the TCP queue.
The default value is a hard-coded constant, which depends on the system.
The maximum supported value depends on the system, too high values may be silently truncated to the 'implementation-specified maximum'.

Default: SOMAXCONN
 Range: 0 - INT_MAX

ListenIP

A list of comma-delimited IP addresses that the trapper should listen on.
Trapper will listen on all network interfaces if this parameter is missing.

Default: 0.0.0.0

ListenPort

The listen port for trapper.

Default: 10051
 Range: 1024-32767

LoadModule

The module to load at proxy startup. Modules are used to extend the functionality of the proxy. The module must be located in the directory specified by LoadModulePath or the path must precede the module name. If the preceding path is absolute (starts with '/') then LoadModulePath is ignored.
Formats:
LoadModule=<module.so>
LoadModule=<path/module.so>
LoadModule=<ab is allowed to include multiple LoadModule parameters.

LoadModulePath

The full path to the location of proxy modules. The default depends on compilation options.

LogFile

The name of the log file.

Mandatory: Yes, if LogType is set to *file*; otherwise no

LogFileSize

The maximum size of a log file in MB.
0 - disable automatic log rotation.
Note: If the log file size limit is reached and file rotation fails, for whatever reason, the existing log file is truncated and started anew.

Default: 1
 Range: 0-1024

LogRemoteCommands

Enable the logging of executed shell commands as warnings.

Default: 0
 Values: 0 - disabled, 1 - enabled

LogType

The type of the log output:
file - write log to the file specified by LogFile parameter;
system - write log to syslog;
console - write log to standard output.

Default: file

LogSlowQueries

How long a database query may take before being logged (in milliseconds).
0 - don't log slow queries.
This option becomes enabled starting with DebugLevel=3.

Default: 0
 Range: 0-3600000

MaxConcurrentChecksPerPoller

The maximum number of asynchronous checks that can be executed at once by each HTTP agent poller, agent poller or SNMP poller. See [StartHTTPAgentPollers](#), [StartAgentPollers](#), and [StartSNMPPollers](#).

Default: 1000
 Range: 1-1000

PidFile

The name of the PID file.

Default: /tmp/zabbix_proxy.pid

ProxyBufferMode

Specifies history, network discovery and autoregistration data storage mechanism: *disk* - data are stored in database and uploaded from database; *memory* - data are stored in memory and uploaded from memory. If buffer runs out of memory the old data will be discarded. On shutdown the buffer is discarded. *hybrid* - the proxy buffer normally works like in the memory mode until it runs out of memory or the oldest record exceeds the configured age. If that happens the buffer is flushed to database and it works like in disk mode until all data have been uploaded and it starts working with memory again. On shutdown the memory buffer is flushed to database.

See also: [Proxy memory buffer](#).

Default: disk
 Values: disk; memory; hybrid

ProxyConfigFrequency

How often the proxy retrieves configuration data from Zabbix server in seconds.
Active proxy parameter. Ignored for passive proxies (see ProxyMode parameter).

Default: 10
 Range: 1-604800

ProxyLocalBuffer

The proxy will keep data locally for N hours, even if the data have already been synced with the server.
This parameter may be used if local data will be used by third-party applications.

Default: 0
 Range: 0-720

ProxyMemoryBufferAge

The maximum age of data in proxy memory buffer, in seconds. When enabled (not zero) and records in proxy memory buffer are older, then it forces proxy buffer to switch to database mode until all records are uploaded to server. This parameter must be less or equal to ProxyOfflineBuffer parameter.

Default: 0
 Range: 0;600-864000

ProxyMemoryBufferSize

The size of shared memory cache for collected history, discovery and autoregistration data, in bytes. If enabled (not zero) proxy will keep history discovery and autoregistration data in memory unless cache is full or stored records are older than defined ProxyMemoryBufferAge. This parameter cannot be used together with ProxyLocalBuffer parameter.

Default: 0
 Range: 0;128K-2G

ProxyMode

The proxy operating mode.
0 - proxy in the active mode
1 - proxy in the passive mode
Note that (sensitive) proxy configuration data may become available to parties having access to the Zabbix server trapper port when using an active proxy. This is possible because anyone may pretend to be an active proxy and request configuration data; authentication does not take place.

Default: 0
 Range: 0-1

ProxyOfflineBuffer

The proxy will keep data for N hours in case of no connectivity with Zabbix server.
Older data will be lost.

Default: 1
 Range: 1-720

Server

If ProxyMode is set to *active mode*:
Zabbix server IP address or DNS name (address:port) or **cluster** (address:port;address2:port) to get configuration data from and send data to.
If port is not specified, the default port is used.
Cluster nodes must be separated by a semicolon.

If ProxyMode is set to *passive mode*:
List of comma delimited IP addresses, optionally in CIDR notation, or DNS names of Zabbix server. Incoming connections will be accepted only from the addresses listed here. If IPv6 support is enabled then '127.0.0.1', '::127.0.0.1', '::ffff:127.0.0.1' are treated equally.
'::/0' will allow any IPv4 or IPv6 address. '0.0.0.0/0' can be used to allow any IPv4 address.

Example:

```
Server=127.0.0.1,192.168.1.0/24,::1,2001:db8::/32,zabbix.example.com
```

Mandatory: yes

SNMPTrapperFile

A temporary file used for passing data from the SNMP trap daemon to the proxy.
Must be the same as in zabbix_trap_receiver.pl or SNMPPTT configuration file.

Default: /tmp/zabbix_traps.tmp

SocketDir

The directory to store IPC sockets used by internal Zabbix services.

Default: /tmp

SourceIP

The source IP address for:
- outgoing connections to Zabbix server;
- agentless connections (VMware, SSH, JMX, SNMP, Telnet and simple checks);
- HTTP agent connections;
- script item JavaScript HTTP requests;
- preprocessing JavaScript HTTP requests;
- connections to the Vault

SSHKeyLocation

The location of public and private keys for SSH checks and actions.

SSLCertLocation

The location of SSL client certificate files for client authentication.
This parameter is used in web monitoring only.

SSLKeyLocation

The location of SSL private key files for client authentication.
This parameter is used in web monitoring only.

SSLCALocation

The location of certificate authority (CA) files for SSL server certificate verification.
Note that the value of this parameter will be set as the CURLOPT_CAPATH libcurl option. For libcurl versions before 7.42.0, this only has effect if libcurl was compiled to use OpenSSL. For more information see the [cURL web page](#).
This parameter is used in web monitoring and in SMTP authentication.

StartAgentPollers

The number of pre-forked instances of Zabbix agent **pollers**. See **MaxConcurrentChecksPerPoller**.

Default: 1
 Range: 0-1000

StartBrowserPollers

The number of pre-forked instances of browser item **pollers**.

Default: 1
 Range: 0-1000

StartDBSyncers

The number of pre-forked instances of **history syncers**.
Note: Be careful when changing this value, increasing it may do more harm than good.

Default: 4
 Range: 1-100

StartDiscoverers

The number of pre-forked instances of **discovery workers**.

Default: 5
 Range: 0-1000

StartHTTPAgentPollers

The number of pre-forked instances of HTTP agent **pollers**. See **MaxConcurrentChecksPerPoller**.

Default: 1
 Range: 0-1000

StartHTTTPollers

The number of pre-forked instances of **HTTP pollers**.

Default: 1 | Range: 0-1000

StartIPMIPollers

The number of pre-forked instances of **IPMI pollers**.

Default: 0
 Range: 0-1000

StartJavaPollers

The number of pre-forked instances of **Java pollers**.

Default: 0
 Range: 0-1000

StartODBCPollers

The number of pre-forked instances of **ODBC pollers**.

Default: 1
 Range: 0-1000

StartPingers

The number of pre-forked instances of **ICMP pingers**.

Default: 1
 Range: 0-1000

StartPollersUnreachable

The number of pre-forked instances of **pollers for unreachable hosts** (including IPMI and Java). At least one poller for unreachable hosts must be running if regular, IPMI or Java pollers are started.

Default: 1
 Range: 0-1000

StartPollers

The number of pre-forked instances of **pollers**.

Default: 5
 Range: 0-1000

StartPreprocessors

The number of pre-started instances of preprocessing **worker** threads should be set to no less than the available CPU core count. More workers should be set if preprocessing is not CPU-bound and has lots of network requests.

Default: 16
 Range: 1-1000

StartSNMPPollers

The number of pre-forked instances of SNMP **pollers**. See **MaxConcurrentChecksPerPoller**.

Default: 1
 Range: 0-1000

StartSNMPTrapper

If set to 1, an **SNMP trapper** process will be started.

Default: 0
 Range: 0-1

StartTrappers

The number of pre-forked instances of **trappers**.
Trappers accept incoming connections from Zabbix sender and active agents.

Default: 5
 Range: 0-1000

StartVMwareCollectors

The number of pre-forked **VMware collector** instances.

Default: 0
 Range: 0-250

StatsAllowedIP

A list of comma-delimited IP addresses, optionally in CIDR notation, or DNS names of external Zabbix instances. The stats request will be accepted only from the addresses listed here. If this parameter is not set no stats requests will be accepted.
If IPv6 support is enabled then '127.0.0.1', '::127.0.0.1', '::ffff:127.0.0.1' are treated equally and '::/0' will allow any IPv4 or IPv6 address. '0.0.0.0/0' can be used to allow any IPv4 address.

Example:

```
StatsAllowedIP=127.0.0.1,192.168.1.0/24,::1,2001:db8::/32,zabbix.example.com
```

Timeout

Specifies how long to wait (in seconds) for establishing connection and exchanging data with Zabbix server, agent, web service, and for SNMP checks (except SNMP `walk[OID]` and `get[OID]` items) and `icmping[*]` item. This parameter defines the duration for various communication operations:

- remote command execution on Zabbix agent;
- SSH / Telnet command execution;
- rescheduling of items when IPMI interface becomes unavailable;
- ICMP pinger;
- sending response to Zabbix server when failing to exchange data due to rights or encryption issues;
- deadline for IPC asynchronous sockets and runtime control options;
- asynchronous poller DNS requests;
- response for active check heartbeat;
- retrieval of Zabbix agent data (values) from active agents;
- retrieval of data from Zabbix sender;
- sending active check list to Zabbix agent.

Default: 3
 Range: 1-30

TLSAccept

What incoming connections to accept from Zabbix server. Used for a passive proxy, ignored on an active proxy. Multiple values can be specified, separated by comma:
unencrypted - accept connections without encryption (default)
psk - accept connections with TLS and a pre-shared key (PSK)
cert - accept connections with TLS and a certificate

Mandatory: yes for passive proxy, if TLS certificate or PSK parameters are defined (even for *unencrypted* connection); otherwise no

TLSCAFile

The full pathname of a file containing the top-level CA(s) certificates for peer certificate verification, used for encrypted communications between Zabbix components.

TLSCertFile

The full pathname of a file containing the proxy certificate or certificate chain, used for encrypted communications between Zabbix components.

TLSCipherAll

The GnuTLS priority string or OpenSSL (TLS 1.2) cipher string. Override the default ciphersuite selection criteria for certificate- and PSK-based encryption.

Example:

```
TLS_AES_256_GCM_SHA384:TLS_CHACHA20_POLY1305_SHA256:TLS_AES_128_GCM_SHA256
```

TLSCipherAll13

The cipher string for OpenSSL 1.1.1 or newer in TLS 1.3. Override the default ciphersuite selection criteria for certificate- and PSK-based encryption.

Example for GnuTLS:

```
NONE:+VERS-TLS1.2:+ECDHE-RSA:+RSA:+ECDHE-PSK:+PSK:+AES-128-GCM:+AES-128-CBC:+AEAD:+SHA256:+SHA1:+CURVE-ALL
```

Example for OpenSSL:

```
EECDH+aRSA+AES128:RSA+aRSA+AES128:kECDHEPSK+AES128:kPSK+AES128
```

TLSCipherCert

The GnuTLS priority string or OpenSSL (TLS 1.2) cipher string. Override the default ciphersuite selection criteria for certificate-based encryption.

Example for GnuTLS:

```
NONE:+VERS-TLS1.2:+ECDHE-RSA:+RSA:+AES-128-GCM:+AES-128-CBC:+AEAD:+SHA256:+SHA1:+CURVE-ALL:+COMP-NULL:+SIG
```

Example for OpenSSL:

```
EECDH+aRSA+AES128:RSA+aRSA+AES128
```

TLSCipherCert13

The cipher string for OpenSSL 1.1.1 or newer in TLS 1.3. Override the default ciphersuite selection criteria for certificate-based encryption.

TLSCipherPSK

The GnuTLS priority string or OpenSSL (TLS 1.2) cipher string. Override the default ciphersuite selection criteria for PSK-based encryption.

Example for GnuTLS:

```
NONE:+VERS-TLS1.2:+ECDHE-PSK:+PSK:+AES-128-GCM:+AES-128-CBC:+AEAD:+SHA256:+SHA1:+CURVE-ALL:+COMP-NULL:+SIG
```

Example for OpenSSL:

```
kECDHEPSK+AES128:kPSK+AES128
```

TLSCipherPSK13

The cipher string for OpenSSL 1.1.1 or newer in TLS 1.3. Override the default ciphersuite selection criteria for PSK-based encryption.

Example:

```
TLS_CHACHA20_POLY1305_SHA256:TLS_AES_128_GCM_SHA256
```

TLSConnect

How the proxy should connect to Zabbix server. Used for an active proxy, ignored on a passive proxy. Only one value can be specified:
unencrypted - connect without encryption (default)
psk - connect using TLS and a pre-shared key (PSK)
cert - connect using TLS and a certificate

Mandatory: yes for active proxy, if TLS certificate or PSK parameters are defined (even for *unencrypted* connection); otherwise no

TLSCRLFile

The full pathname of a file containing revoked certificates. This parameter is used for encrypted communications between Zabbix components.

TLSSKeyFile

The full pathname of a file containing the proxy private key, used for encrypted communications between Zabbix components.

TLSPSKFile

The full pathname of a file containing the proxy pre-shared key, used for encrypted communications with Zabbix server.

TLSPSKIdentity

The pre-shared key identity string, used for encrypted communications with Zabbix server.

TLSServerCertIssuer

The allowed server certificate issuer.

TLSServerCertSubject

The allowed server certificate subject.

TmpDir

The temporary directory.

Default: /tmp

TrapperTimeout

Specifies timeout in seconds for:
 - retrieval of configuration data from the Zabbix server;
 - global script execution or remote command execution.

Default: 300
 Range: 1-300

UnavailableDelay

How often a host is checked for availability during the **unavailability** period in seconds.

Default: 60
 Range: 1-3600

UnreachableDelay

How often a host is checked for availability during the **unreachability** period in seconds.

Default: 15
 Range: 1-3600

UnreachablePeriod

After how many seconds of **unreachability** treat a host as unavailable.

Default: 45
 Range: 1-3600

User

Drop privileges to a specific, existing user on the system.
Only has effect if run as 'root' and AllowRoot is disabled.

Default: zabbix

Vault

The vault provider:
HashiCorp - HashiCorp KV Secrets Engine version 2
CyberArk - CyberArk Central Credential Provider
Must match the vault provider set in the frontend.

Default: HashiCorp

VaultDBPath

The location from where database credentials should be retrieved by keys. Depending on the vault, can be vault path or query.
The keys used for HashiCorp are 'password' and 'username'.

Example:

```
secret/zabbix/database
```

The keys used for CyberArk are 'Content' and 'UserName'.

Example:

```
AppID=zabbix_server&Query=Safe=passwordSafe;Object=zabbix_proxy_database
```

This option can only be used if DBUser and DBPassword are not specified.

VaultPrefix

A custom prefix for the vault path or query, depending on the vault; if not specified, the most suitable defaults will be used.

VaultTLSCertFile

The name of the SSL certificate file used for client authentication. The certificate file must be in PEM1 format.
If the certificate file contains also the private key, leave the SSL key file field empty.
The directory containing this file is specified by the SSLCertLocation configuration parameter.
This option can be omitted, but is recommended for CyberArkCCP vault.

VaultTLSKeyFile

The name of the SSL private key file used for client authentication. The private key file must be in PEM1 format.
The directory containing this file is specified by the SSLKeyLocation configuration parameter.
This option can be omitted, but is recommended for CyberArkCCP vault.

VaultToken

The HashiCorp vault authentication token that should have been generated exclusively for Zabbix proxy with read-only permission to the path specified in the optional VaultDBPath configuration parameter.
It is an error if VaultToken and the VAULT_TOKEN environment variable are defined at the same time.

Mandatory: Yes, if Vault is set to *HashiCorp*; otherwise no

VaultURL

The vault server HTTP[S] URL. The system-wide CA certificates directory will be used if SSLCAlocation is not specified.

Default: `https://127.0.0.1:8200`

VMwareCacheSize

The shared memory size for storing VMware data.
A VMware internal check `zabbix[vmware,buffer,...]` can be used to monitor the VMware cache usage (see [Internal checks](#)).
Note that shared memory is not allocated if there are no vmware collector instances configured to start.

Default: 8M
 Range: 256K-2G

VMwareFrequency

The delay in seconds between data gathering from a single VMware service.
This delay should be set to the least update interval of any VMware monitoring item.

Default: 60
 Range: 10-86400

VMwarePerfFrequency

The delay in seconds between performance counter statistics retrieval from a single VMware service.
This delay should be set to the least update interval of any VMware monitoring [item](#) that uses VMware performance counters.

Default: 60
 Range: 10-86400

VMwareTimeout

The maximum number of seconds a vmware collector will wait for a response from VMware service (vCenter or ESX hypervisor).

Default: 10
 Range: 1-300

WebDriverURL

WebDriver interface HTTP[S] URL.

Example (used with Selenium WebDriver standalone server):

`WebDriverURL=http://localhost:4444`

3 Zabbix agent (UNIX)

Overview

The parameters supported by the Zabbix agent configuration file (`zabbix_agentd.conf`) are listed in this section.

The parameters are listed without additional information. Click on the parameter to see the full details.

Parameter	Description
Alias	Sets an alias for an item key.
AllowKey	Allow the execution of those item keys that match a pattern.
AllowRoot	Allow the agent to run as 'root'.
BufferSend	Do not keep data longer than N seconds in buffer.
BufferSize	The maximum number of values in the memory buffer.
DebugLevel	The debug level.
DenyKey	Deny the execution of those item keys that match a pattern.
EnableRemoteCommands	Whether remote commands from Zabbix server are allowed.
HeartbeatFrequency	The frequency of heartbeat messages in seconds.
HostInterface	An optional parameter that defines the host interface.
HostInterfaceItem	An optional parameter that defines an item used for getting the host interface.

Parameter	Description
HostMetadata	An optional parameter that defines the host metadata.
HostMetadataItem	An optional parameter that defines a Zabbix agent item used for getting the host metadata.
Hostname	An optional parameter that defines the hostname.
HostnameItem	An optional parameter that defines a Zabbix agent item used for getting the hostname.
Include	You may include individual files or all files in a directory in the configuration file.
ListenBacklog	The maximum number of pending connections in the TCP queue.
ListenIP	A list of comma-delimited IP addresses that the agent should listen on.
ListenPort	The agent will listen on this port for connections from the server.
LoadModule	The module to load at agent startup.
LoadModulePath	The full path to the location of agent modules.
LogFile	The name of the log file.
LogFileSize	The maximum size of the log file.
LogRemoteCommands	Enable logging of executed shell commands as warnings.
LogType	The type of the log output.
MaxLinesPerSecond	The maximum number of new lines the agent will send per second to Zabbix server or proxy when processing 'log' and 'logrt' active checks.
PidFile	The name of the PID file.
RefreshActiveChecks	How often the list of active checks is refreshed.
Server	A list of comma-delimited IP addresses, optionally in CIDR notation, or DNS names of Zabbix servers and Zabbix proxies.
ServerActive	The Zabbix server/proxy address or cluster configuration to get active checks from.
SourceIP	The source IP address.
StartAgents	The number of pre-forked instances of zabbix_agentd that process passive checks.
Timeout	Specifies how long to wait (in seconds) for establishing connection and exchanging data with Zabbix proxy or server.
TLSAccept	What incoming connections to accept.
TLSCAFile	The full pathname of a file containing the top-level CA(s) certificates for peer certificate verification, used for encrypted communications between Zabbix components.
TLSCertFile	The full pathname of a file containing the agent certificate or certificate chain, used for encrypted communications between Zabbix components.
TLSCipherAll	The GnuTLS priority string or OpenSSL (TLS 1.2) cipher string. Override the default ciphersuite selection criteria for certificate- and PSK-based encryption.
TLSCipherAll13	The cipher string for OpenSSL 1.1.1 or newer in TLS 1.3. Override the default ciphersuite selection criteria for certificate- and PSK-based encryption.
TLSCipherCert	The GnuTLS priority string or OpenSSL (TLS 1.2) cipher string. Override the default ciphersuite selection criteria for certificate-based encryption.
TLSCipherCert13	The cipher string for OpenSSL 1.1.1 or newer in TLS 1.3. Override the default ciphersuite selection criteria for certificate-based encryption.
TLSCipherPSK	The GnuTLS priority string or OpenSSL (TLS 1.2) cipher string. Override the default ciphersuite selection criteria for PSK-based encryption.
TLSCipherPSK13	The cipher string for OpenSSL 1.1.1 or newer in TLS 1.3. Override the default ciphersuite selection criteria for PSK-based encryption.
TLSConnect	How the agent should connect to Zabbix server or proxy.
TLSCRLFile	The full pathname of a file containing revoked certificates. This parameter is used for encrypted communications between Zabbix components.
TLSKeyFile	The full pathname of a file containing the agent private key, used for encrypted communications between Zabbix components.
TLSPSKFile	The full pathname of a file containing the agent pre-shared key, used for encrypted communications with Zabbix server.
TLSPSKIdentity	The pre-shared key identity string, used for encrypted communications with Zabbix server.
TLSServerCertIssuer	The allowed server (proxy) certificate issuer.
TLSServerCertSubject	The allowed server (proxy) certificate subject.
UnsafeUserParameters	Allow all characters to be passed in arguments to user-defined parameters.
User	Drop privileges to a specific, existing user on the system.
UserParameter	A user-defined parameter to monitor.
UserParameterDir	The default search path for UserParameter commands.

All parameters are non-mandatory unless explicitly stated that the parameter is mandatory.

Note that:

- The default values reflect daemon defaults, not the values in the shipped configuration files;

- Values support [environment variables](#);
- Zabbix supports configuration files only in UTF-8 encoding without [BOM](#);
- Comments starting with "#" are only supported in the beginning of the line.

Parameter details

Alias

Sets an alias for an item key. It can be used to substitute a long and complex item key with a shorter and simpler one.
Multiple *Alias* parameters may be present. Multiple parameters with the same *Alias* key are not allowed.
Different *Alias* keys may reference the same item key.
Aliases can be used in *HostMetadataItem* but not in *HostnameItem* parameter.

Example 1: Retrieving the ID of user 'zabbix'.

```
Alias=zabbix.userid:vfs.file.regexp[/etc/passwd,"^zabbix:.:([0-9]+)",,,\1]
```

Now the **zabbix.userid** shorthand key may be used to retrieve data.

Example 2: Getting CPU utilization with default and custom parameters.

```
Alias=cpu.util:system.cpu.util
Alias=cpu.util[*]:system.cpu.util[*]
```

This allows use the **cpu.util** key to get CPU utilization percentage with default parameters as well as use **cpu.util[all, idle, avg15]** to get specific data about CPU utilization.

Example 3: Running multiple [low-level discovery](#) rules processing the same discovery items.

```
Alias=vfs.fs.discovery[*]:vfs.fs.discovery
```

Now it is possible to set up several discovery rules using **vfs.fs.discovery** with different parameters for each rule, e.g., **vfs.fs.discovery[foo]**, **vfs.fs.discovery[bar]**, etc.

AllowKey

Allow the execution of those item keys that match a pattern. The key pattern is a wildcard expression that supports the "*" character to match any number of any characters.
Multiple key matching rules may be defined in combination with DenyKey. The parameters are processed one by one according to their appearance order. See also: [Restricting agent checks](#).

AllowRoot

Allow the agent to run as 'root'. If disabled and the agent is started by 'root', the agent will try to switch to user 'zabbix' instead. Has no effect if started under a regular user.

Default: 0
 Values: 0 - do not allow; 1 - allow

BufferSend

Do not keep data longer than N seconds in buffer.

Default: 5
 Range: 1-3600

BufferSize

The maximum number of values in the memory buffer. The agent will send all collected data to the Zabbix server or proxy if the buffer is full.

Default: 100
 Range: 2-65535

DebugLevel

Specify the debug level:
0 - basic information about starting and stopping of Zabbix processes
1 - critical information;
2 - error information;
3 - warnings;
4 - for debugging (produces lots of information);
5 - extended debugging (produces even more information).

Default: 3
 Range: 0-5

DenyKey

Deny the execution of those item keys that match a pattern. The key pattern is a wildcard expression that supports the "*" character to match any number of any characters.
Multiple key matching rules may be defined in combination with AllowKey. The parameters are processed one by one according to their appearance order. See also: [Restricting agent checks](#).

EnableRemoteCommands

Whether remote commands from Zabbix server are allowed. This parameter is **deprecated**, use `AllowKey=system.run[*]` or `DenyKey=system.run[*]` instead.
It is an internal alias for AllowKey/DenyKey parameters depending on value:
0 - DenyKey=system.run[*]
1 - AllowKey=system.run[*]

Default: 0
 Values: 0 - do not allow, 1 - allow

HeartbeatFrequency

The frequency of heartbeat messages in seconds. Used for monitoring the availability of active checks.
0 - heartbeat messages disabled.

Default: 60
 Range: 0-3600

HostInterface

An optional parameter that defines the host interface. The host interface is used at host **autoregistration** process. If not defined, the value will be acquired from HostInterfaceltem.
The agent will issue an error and not start if the value is over the limit of 255 characters.

Range: 0-255 characters

HostInterfaceltem

An optional parameter that defines an item used for getting the host interface.
Host interface is used at host **autoregistration** process.
During an autoregistration request the agent will log a warning message if the value returned by the specified item is over the limit of 255 characters.
The **system.run[]** item is supported regardless of AllowKey/DenyKey values.
This option is only used when HostInterface is not defined.

HostMetadata

An optional parameter that defines host metadata. Host metadata is used only at host autoregistration process (active agent). If not defined, the value will be acquired from HostMetadataltem.
The agent will issue an error and not start if the specified value is over the limit of 2034 bytes or a non-UTF-8 string.

Range: 0-2034 bytes

HostMetadataltem

An optional parameter that defines a Zabbix agent item used for getting host metadata. This option is only used when HostMetadata is not defined. User parameters and aliases are supported. The **system.run[]** item is supported regardless of AllowKey/DenyKey values.
The HostMetadataltem value is retrieved on each autoregistration attempt and is used only at host autoregistration process (active agent).
During an autoregistration request the agent will log a warning message if the value returned by the specified item is over the limit of 65535 UTF-8 code points. The value returned by the item must be a UTF-8 string otherwise it will be ignored.

Hostname

A list of comma-delimited, unique, case-sensitive hostnames. Required for active checks and must match hostnames as configured on the server. The value is acquired from Hostnameltem if undefined.
Allowed characters: alphanumeric, '.', ',', '_', and '-'.
Maximum length: 128 characters per hostname, 2048 characters for the entire line.

Default: Set by Hostnameltem

Hostnameltem

An optional parameter that defines a Zabbix agent item used for getting the host name. This option is only used when Hostname is not defined. User parameters or aliases are not supported, but the **system.run[]** item is supported regardless of AllowKey/DenyKey values.

Default: `system.hostname`

Include

You may include individual files or all files in a directory in the configuration file. To only include relevant files in the specified directory, the asterisk wildcard character is supported for pattern matching.
See **special notes** about limitations.

Example:

```
Include=/absolute/path/to/config/files/*.conf
```

ListenBacklog

The maximum number of pending connections in the TCP queue.
The default value is a hard-coded constant, which depends on the system.
The maximum supported value depends on the system, too high values may be silently truncated to the 'implementation-specified maximum'.

Default: SOMAXCONN
 Range: 0 - INT_MAX

ListenIP

A list of comma-delimited IP addresses that the agent should listen on.

Default: 0.0.0.0

ListenPort

The agent will listen on this port for connections from the server.

Default: 10050
 Range: 1024-32767

LoadModule

The module to load at agent startup. Modules are used to extend the functionality of the agent. The module must be located in the directory specified by LoadModulePath or the path must precede the module name. If the preceding path is absolute (starts with '/') then LoadModulePath is ignored.
Formats:
LoadModule=<module.so>
LoadModule=<path/module.so>
LoadModule=</ab is allowed to include multiple LoadModule parameters.

LoadModulePath

The full path to the location of agent modules. The default depends on compilation options.

LogFile

The name of the log file.

Mandatory: Yes, if LogType is set to *file*; otherwise no

LogFileSize

The maximum size of a log file in MB.
0 - disable automatic log rotation.
Note: If the log file size limit is reached and file rotation fails, for whatever reason, the existing log file is truncated and started anew.

Default: 1
 Range: 0-1024

LogRemoteCommands

Enable logging of the executed shell commands as warnings. Commands will be logged only if executed remotely. Log entries will not be created if system.run[] is launched locally by HostMetadataItem, HostInterfaceItem or HostnameItem parameters.

Default: 0
 Values: 0 - disabled, 1 - enabled

LogType

The type of the log output:
file - write log to the file specified by LogFile parameter;
system - write log to syslog;
console - write log to standard output.

Default: file

MaxLinesPerSecond

The maximum number of new lines the agent will send per second to Zabbix server or proxy when processing 'log' and 'logrt' active checks. The provided value will be overridden by the 'maxlines' parameter, provided in the 'log' or 'logrt' item key.
Note: Zabbix will process 10 times more new lines than set in MaxLinesPerSecond to seek the required string in log items.

Default: 20
 Range: 1-1000

PidFile

The name of the PID file.

Default: /tmp/zabbix_agentd.pid

RefreshActiveChecks

How often the list of active checks is refreshed, in seconds. Note that after failing to refresh active checks the next refresh will be attempted in 60 seconds.

Default: 5
 Range: 1-86400

Server

A list of comma-delimited IP addresses, optionally in CIDR notation, or DNS names of Zabbix servers and Zabbix proxies. Incoming connections will be accepted only from the hosts listed here. If IPv6 support is enabled then '127.0.0.1', '::127.0.0.1', '::ffff:127.0.0.1' are treated equally and '::/0' will allow any IPv4 or IPv6 address. '0.0.0.0/0' can be used to allow any IPv4 address. Note that "IPv4-compatible IPv6 addresses" (0000::/96 prefix) are supported but deprecated by [RFC4291](#). Spaces are allowed.

Example:

Server=127.0.0.1,192.168.1.0/24,:::1,2001:db8::/32,zabbix.example.com

Mandatory: yes, if StartAgents is not explicitly set to 0

ServerActive

The Zabbix server/proxy address or cluster configuration to get active checks from. The server/proxy address is an IP address or DNS name and optional port separated by colon.
Cluster configuration is one or more server addresses separated by semicolon. Multiple Zabbix servers/clusters and Zabbix proxies can be specified, separated by comma. More than one Zabbix proxy should not be specified from each Zabbix server/cluster. If Zabbix proxy is specified then Zabbix server/cluster for that proxy should not be specified.
Multiple comma-delimited addresses can be provided to use several independent Zabbix servers in parallel. Spaces are allowed.
If the port is not specified, default port is used.
IPv6 addresses must be enclosed in square brackets if port for that host is specified. If port is not specified, square brackets for IPv6 addresses are optional.
If this parameter is not specified, active checks are disabled.

Example for Zabbix proxy:

```
ServerActive=127.0.0.1:10051
```

Example for multiple servers:

```
ServerActive=127.0.0.1:20051,zabbix.domain,[::1]:30051,::1,[12fc::1]
```

Example for high availability:

```
ServerActive=zabbix.cluster.node1;zabbix.cluster.node2:20051;zabbix.cluster.node3
```

Example for high availability with two clusters and one server:

```
ServerActive=zabbix.cluster.node1;zabbix.cluster.node2:20051,zabbix.cluster2.node1;zabbix.cluster2.node2,z
```

SourceIP

The source IP address for:
- outgoing connections to Zabbix server or Zabbix proxy;
- making connections while executing some items (web.page.get, net.tcp.port, etc.).

StartAgents

The number of pre-forked instances of zabbix_agentd that process passive checks. If set to 0, passive checks are disabled and the agent will not listen on any TCP port.

Default: 10
 Range: 0-100

Timeout

Specifies how long to wait (in seconds) for establishing connection and exchanging data with Zabbix proxy or server.
 This parameter defines the duration of various operations, including:
 - awaiting a response from the Zabbix server;
 - sending requests to Zabbix server, including **active checks** configuration requests and item data;
 - retrieving log data through logfile or Windows event log monitoring;
 - sending heartbeat messages;
 - maximum duration for `vfs.*` checks;
 - being used by Zabbix agent modules;
 - serving as a fallback in scenarios where a server or proxy older than version 7.0 sends checks without timeouts.

Default: 3
 Range: 1-30

TLSAccept

What incoming connections to accept. Used for a passive checks. Multiple values can be specified, separated by comma:
unencrypted - accept connections without encryption (default)
psk - accept connections with TLS and a pre-shared key (PSK)
cert - accept connections with TLS and a certificate

Mandatory: yes, if TLS certificate or PSK parameters are defined (even for *unencrypted* connection); otherwise no

TLSCAFile

The full pathname of the file containing the top-level CA(s) certificates for peer certificate verification, used for encrypted communications between Zabbix components.

TLSCertFile

The full pathname of the file containing the agent certificate or certificate chain, used for encrypted communications with Zabbix components.

TLSCipherAll

The GnuTLS priority string or OpenSSL (TLS 1.2) cipher string. Override the default ciphersuite selection criteria for certificate- and PSK-based encryption.

Example:

TLS_AES_256_GCM_SHA384:TLS_CHACHA20_POLY1305_SHA256:TLS_AES_128_GCM_SHA256

TLSCipherAll13

The cipher string for OpenSSL 1.1.1 or newer in TLS 1.3. Override the default ciphersuite selection criteria for certificate- and PSK-based encryption.

Example for GnuTLS:

NONE:+VERS-TLS1.2:+ECDHE-RSA:+RSA:+ECDHE-PSK:+PSK:+AES-128-GCM:+AES-128-CBC:+AEAD:+SHA256:+SHA1:+CURVE-ALL

Example for OpenSSL:

EECDH+aRSA+AES128:RSA+aRSA+AES128:kECDHEPSK+AES128:kPSK+AES128

TLSCipherCert

The GnuTLS priority string or OpenSSL (TLS 1.2) cipher string. Override the default ciphersuite selection criteria for certificate-based encryption.

Example for GnuTLS:

NONE:+VERS-TLS1.2:+ECDHE-RSA:+RSA:+AES-128-GCM:+AES-128-CBC:+AEAD:+SHA256:+SHA1:+CURVE-ALL:+COMP-NULL:+SIG

Example for OpenSSL:

EECDH+aRSA+AES128:RSA+aRSA+AES128

TLSCipherCert13

The cipher string for OpenSSL 1.1.1 or newer in TLS 1.3. Override the default ciphersuite selection criteria for certificate-based encryption.

TLSCipherPSK

The GnuTLS priority string or OpenSSL (TLS 1.2) cipher string. Override the default ciphersuite selection criteria for PSK-based encryption.

Example for GnuTLS:

NONE:+VERS-TLS1.2:+ECDHE-PSK:+PSK:+AES-128-GCM:+AES-128-CBC:+AEAD:+SHA256:+SHA1:+CURVE-ALL:+COMP-NULL:+SIG

Example for OpenSSL:

kECDHEPSK+AES128:kPSK+AES128

TLSCipherPSK13

The cipher string for OpenSSL 1.1.1 or newer in TLS 1.3. Override the default ciphersuite selection criteria for PSK-based encryption.

Example:

TLS_CHACHA20_POLY1305_SHA256:TLS_AES_128_GCM_SHA256

TLSConnect

How the agent should connect to Zabbix server or proxy. Used for active checks. Only one value can be specified:

unencrypted - connect without encryption (default)

psk - connect using TLS and a pre-shared key (PSK)

cert - connect using TLS and a certificate

Mandatory: yes, if TLS certificate or PSK parameters are defined (even for *unencrypted* connection); otherwise no

TLSCRLFile

The full pathname of the file containing revoked certificates. This parameter is used for encrypted communications between Zabbix components.

TLSSignKeyFile

The full pathname of the file containing the agent private key, used for encrypted communications between Zabbix components.

TLSPSKFile

The full pathname of the file containing the agent pre-shared key, used for encrypted communications with Zabbix server.

TLSPSKIdentity

The pre-shared key identity string, used for encrypted communications with Zabbix server.

TLSServerCertIssuer

The allowed server (proxy) certificate issuer.

TLSServerCertSubject

The allowed server (proxy) certificate subject.

UnsafeUserParameters

Allow all characters to be passed in arguments to user-defined parameters. The following characters are not allowed: \ ' " ' * ? [] { } ~ \$! & ; () < > | # @
Additionally, newline characters are not allowed.

Default: 0
 Values: 0 - do not allow, 1 - allow

User

Drop privileges to a specific, existing user on the system.
Only has effect if run as 'root' and AllowRoot is disabled.

Default: zabbix

UserParameter

A user-defined parameter to monitor. There can be several user-defined parameters.
Format: UserParameter=<key>,<shell command>
Note that the shell command must not return empty string or EOL only. Shell commands may have relative paths, if the UserParameterDir parameter is specified.

Example:

```
UserParameter=system.test,who|wc -l  
UserParameter=check_cpu,./custom_script.sh
```

UserParameterDir

The default search path for UserParameter commands. If used, the agent will change its working directory to the one specified here before executing a command. Thereby, UserParameter commands can have a relative ./ prefix instead of a full path.
Only one entry is allowed.

Example:

```
UserParameterDir=/opt/myscripts
```

See also

1. [Differences in the Zabbix agent configuration for active and passive checks starting from version 2.0.0](#)

4 Zabbix agent 2 (UNIX)

Overview

Zabbix agent 2 is a new generation of Zabbix agent and may be used in place of Zabbix agent.

The parameters supported by the Zabbix agent 2 configuration file (zabbix_agent2.conf) are listed in this section.

The parameters are listed without additional information. Click on the parameter to see the full details.

Parameter	Description
Alias	Sets an alias for an item key.
AllowKey	Allow the execution of those item keys that match a pattern.
BufferSend	Do not keep data longer than N seconds in buffer.
BufferSize	The maximum number of values in the memory buffer.
ControlSocket	The control socket, used to send runtime commands with the '-R' option.
DebugLevel	The debug level.
DenyKey	Deny the execution of those item keys that match a pattern.
EnablePersistentBuffer	Enable the usage of local persistent storage for active items.
ForceActiveChecksOnStart	Perform active checks immediately after the restart for the first received configuration.
HeartbeatFrequency	The frequency of heartbeat messages in seconds.
HostInterface	An optional parameter that defines the host interface.
HostInterfaceItem	An optional parameter that defines an item used for getting the host interface.
HostMetadata	An optional parameter that defines the host metadata.
HostMetadataItem	An optional parameter that defines a Zabbix agent item used for getting the host metadata.
Hostname	An optional parameter that defines the hostname.
HostnameItem	An optional parameter that defines a Zabbix agent item used for getting the hostname.
Include	You may include individual files or all files in a directory in the configuration file.

Parameter	Description
ListenIP	A list of comma-delimited IP addresses that the agent should listen on.
ListenPort	The agent will listen on this port for connections from the server.
LogFile	The name of the log file.
LogFileSize	The maximum size of the log file.
LogType	The type of the log output.
PersistentBufferFile	The file where Zabbix agent 2 should keep the SQLite database.
PersistentBufferPeriod	The time period for which data should be stored when there is no connection to the server or proxy.
PidFile	The name of the PID file.
Plugins.<PluginName>.System.Capacity	The number of checks per plugin that can be executed at the same time.
Plugins.Log.MaxLinesPerSecond	The maximum number of new lines the agent will send per second to Zabbix server or proxy when processing 'log' and 'logrt' active checks.
Plugins.SystemRun.LogRemote	Enable the logging of the executed shell commands as warnings.
PluginSocket	The path to the UNIX socket for loadable plugin communications.
PluginTimeout	The timeout for connections with loadable plugins, in seconds.
RefreshActiveChecks	How often the list of active checks is refreshed.
Server	A list of comma-delimited IP addresses, optionally in CIDR notation, or DNS names of Zabbix servers and Zabbix proxies.
ServerActive	The Zabbix server/proxy address or cluster configuration to get active checks from.
SourceIP	The source IP address.
StatusPort	If set, the agent will listen on this port for HTTP status requests (<a href="http://localhost:<port>/status">http://localhost:<port>/status).
Timeout	Specifies how long to wait (in seconds) for establishing connection and exchanging data with Zabbix proxy or server.
TLSAccept	What incoming connections to accept.
TLSCAFile	The full pathname of a file containing the top-level CA(s) certificates for peer certificate verification, used for encrypted communications between Zabbix components.
TLSCertFile	The full pathname of a file containing the agent certificate or certificate chain, used for encrypted communications between Zabbix components.
TLSCipherAll	The OpenSSL cipher string (TLS 1.2). Override the default ciphersuite selection criteria for certificate- and PSK-based encryption.
TLSCipherAll13	The OpenSSL cipher string (TLS 1.3) for OpenSSL 1.1.1 or newer. Override the default ciphersuite selection criteria for certificate- and PSK-based encryption.
TLSCipherCert	The OpenSSL cipher string (TLS 1.2). Override the default ciphersuite selection criteria for certificate-based encryption.
TLSCipherCert13	The OpenSSL cipher string (TLS 1.3) for OpenSSL 1.1.1 or newer. Override the default ciphersuite selection criteria for certificate-based encryption.
TLSCipherPSK	The OpenSSL cipher string (TLS 1.2). Override the default ciphersuite selection criteria for PSK-based encryption.
TLSCipherPSK13	The OpenSSL cipher string (TLS 1.3) for OpenSSL 1.1.1 or newer. Override the default ciphersuite selection criteria for PSK-based encryption.
TLSConnect	How the agent should connect to Zabbix server or proxy.
TLSCTRLFile	The full pathname of a file containing revoked certificates. This parameter is used for encrypted communications between Zabbix components.
TLSKeyFile	The full pathname of a file containing the agent private key, used for encrypted communications between Zabbix components.
TLSPSKFile	The full pathname of a file containing the agent pre-shared key, used for encrypted communications with Zabbix server.
TLSPSKIdentity	The pre-shared key identity string, used for encrypted communications with Zabbix server.
TLSServerCertIssuer	The allowed server (proxy) certificate issuer.
TLSServerCertSubject	The allowed server (proxy) certificate subject.
UnsafeUserParameters	Allow all characters to be passed in arguments to user-defined parameters.
UserParameter	A user-defined parameter to monitor.
UserParameterDir	The default search path for UserParameter commands.

All parameters are non-mandatory unless explicitly stated that the parameter is mandatory.

Note that:

- The default values reflect process defaults, not the values in the shipped configuration files;
- Values support **environment variables**;
- Zabbix supports configuration files only in UTF-8 encoding without **BOM**;
- Comments starting with **"#"** are only supported in the beginning of the line.

Parameter details

Alias

Sets an alias for an item key. It can be used to substitute a long and complex item key with a shorter and simpler one.
Multiple *Alias* parameters may be present. Multiple parameters with the same *Alias* key are not allowed.
Different *Alias* keys may reference the same item key.
Aliases can be used in *HostMetadataItem* but not in *HostnameItem* parameter.

Example 1: Retrieving the ID of user 'zabbix'.

```
Alias=zabbix.userid:vfs.file.regexp[/etc/passwd,"^zabbix: :([0-9]+)",,,\1]
```

Now the **zabbix.userid** shorthand key may be used to retrieve data.

Example 2: Getting CPU utilization with default and custom parameters.

```
Alias=cpu.util:system.cpu.util  
Alias=cpu.util[*]:system.cpu.util[*]
```

This allows use the **cpu.util** key to get CPU utilization percentage with default parameters as well as use **cpu.util[all, idle, avg15]** to get specific data about CPU utilization.

Example 3: Running multiple **low-level discovery** rules processing the same discovery items.

```
Alias=vfs.fs.discovery[*]:vfs.fs.discovery
```

Now it is possible to set up several discovery rules using **vfs.fs.discovery** with different parameters for each rule, e.g., **vfs.fs.discovery[foo]**, **vfs.fs.discovery[bar]**, etc.

AllowKey

Allow the execution of those item keys that match a pattern. The key pattern is a wildcard expression that supports the "*" character to match any number of any characters.
Multiple key matching rules may be defined in combination with DenyKey. The parameters are processed one by one according to their appearance order. See also: [Restricting agent checks](#).

BufferSend

The time interval in seconds which determines how often values are sent from the buffer to Zabbix server. Note that if the buffer is full, the data will be sent sooner.

Default: 5
 Range: 1-3600

BufferSize

The maximum number of values in the memory buffer. The agent will send all collected data to the Zabbix server or proxy if the buffer is full. This parameter should only be used if persistent buffer is disabled (*EnablePersistentBuffer=0*).

Default: 1000
 Range: 2-65535

ControlSocket

The control socket, used to send runtime commands with the '-R' option.

Default: /tmp/agent.sock

DebugLevel

Specify the debug level:
0 - basic information about starting and stopping of Zabbix processes
1 - critical information;
2 - error information;
3 - warnings;
4 - for debugging (produces lots of information);
5 - extended debugging (produces even more information).

Default: 3
 Range: 0-5

DenyKey

Deny the execution of those item keys that match a pattern. The key pattern is a wildcard expression that supports the "*" character to match any number of any characters.
Multiple key matching rules may be defined in combination with AllowKey. The parameters are processed one by one according to their appearance order. See also: [Restricting agent checks](#).

EnablePersistentBuffer

Enable the usage of local persistent storage for active items. If persistent storage is disabled, the memory buffer will be used.

Default: 0
 Values: 0 - disabled, 1 - enabled

ForceActiveChecksOnStart

Perform active checks immediately after the restart for the first received configuration. Also available as a per-plugin configuration parameter, for example: `Plugins.Uptime.System.ForceActiveChecksOnStart=1`

Default: 0
 Values: 0 - disabled, 1 - enabled

HeartbeatFrequency

The frequency of heartbeat messages in seconds. Used for monitoring the availability of active checks.
0 - heartbeat messages disabled.

Default: 60
 Range: 0-3600

HostInterface

An optional parameter that defines the host interface. The host interface is used at host **autoregistration** process. If not defined, the value will be acquired from HostInterfaceltem.
The agent will issue an error and not start if the value is over the limit of 255 characters.

Range: 0-255 characters

HostInterfaceltem

An optional parameter that defines an item used for getting the host interface.
Host interface is used at host **autoregistration** process. This option is only used when HostInterface is not defined.
The **system.run[]** item is supported regardless of AllowKey/DenyKey values.
During an autoregistration request the agent will log a warning message if the value returned by the specified item is over the limit of 255 characters.

HostMetadata

An optional parameter that defines host metadata. Host metadata is used only at host autoregistration process. If not defined, the value will be acquired from HostMetadataltem.
The agent will issue an error and not start if the specified value is over the limit of 2034 bytes or a non-UTF-8 string.

Range: 0-2034 bytes

HostMetadataltem

An optional parameter that defines an item used for getting host metadata. This option is only used when HostMetadata is not defined. User parameters and aliases are supported. The **system.run[]** item is supported regardless of AllowKey/DenyKey values.
The HostMetadataltem value is retrieved on each autoregistration attempt and is used only at host autoregistration process.
During an autoregistration request the agent will log a warning message if the value returned by the specified item is over the limit of 65535 UTF-8 code points. The value returned by the item must be a UTF-8 string otherwise it will be ignored.

Hostname

A list of comma-delimited, unique, case-sensitive hostnames. Required for active checks and must match hostnames as configured on the server. The value is acquired from Hostnameltem if undefined.
Allowed characters: alphanumeric, '.', ',', '_', and '-'.
Maximum length: 128 characters per hostname, 2048 characters for the entire line.

Default: Set by Hostnameltem

Hostnameltem

An optional parameter that defines an item used for getting the host name. This option is only used when Hostname is not defined. User parameters or aliases are not supported, but the **system.run[]** item is supported regardless of AllowKey/DenyKey values.

Default: `system.hostname`

Include

You may include individual files or all files in a directory in the configuration file. During the installation Zabbix will create the include directory in `/usr/local/etc`, unless modified during the compile time. The path can be relative to the `zabbix_agent2.conf` file location.
To only include relevant files in the specified directory, the asterisk wildcard character is supported for pattern matching.
See **special notes** about limitations.

Example:

```
Include=/absolute/path/to/config/files/*.conf
```

ListenIP

A list of comma-delimited IP addresses that the agent should listen on. The first IP address is sent to the Zabbix server, if connecting to it, to retrieve the list of active checks.

Default: `0.0.0.0`

ListenPort

The agent will listen on this port for connections from the server.

Default: 10050
 Range: 1024-32767

LogFile

The name of the log file.

Default: /tmp/zabbix_agent2.log
 Mandatory: Yes, if LogType is set to *file*; otherwise no

LogFileSize

The maximum size of a log file in MB.
0 - disable automatic log rotation.
Note: If the log file size limit is reached and file rotation fails, for whatever reason, the existing log file is truncated and started anew.

Default: 1
 Range: 0-1024

LogType

The type of the log output:
file - write log to the file specified by LogFile parameter;
system - write log to syslog;
console - write log to standard output

Default: *file*

PersistentBufferFile

The file where Zabbix agent 2 should keep the SQLite database. Must be a full filename. This parameter is only used if persistent buffer is enabled (*EnablePersistentBuffer=1*).

PersistentBufferPeriod

The time period for which data should be stored when there is no connection to the server or proxy. Older data will be lost. Log data will be preserved. This parameter is only used if persistent buffer is enabled (*EnablePersistentBuffer=1*).

Default: 1h
 Range: 1m-365d

PidFile

The name of the PID file.

Default: /tmp/zabbix_agent2.pid

Plugins.<PluginName>.System.Capacity

The limit of checks per <PluginName> plugin that can be executed at the same time.

Default: 1000 Range: 1-1000

Plugins.Log.MaxLinesPerSecond

The maximum number of new lines the agent will send per second to Zabbix server or proxy when processing 'log' and 'logrt' active checks. The provided value will be overridden by the 'maxlines' parameter, provided in the 'log' and 'logrt' item key.
Note: Zabbix will process 10 times more new lines than set in *MaxLinesPerSecond* to seek the required string in log items.

Default: 20
 Range: 1-1000

Plugins.SystemRun.LogRemoteCommands

Enable the logging of the executed shell commands as warnings. The commands will be logged only if executed remotely. Log entries will not be created if system.run[] is launched locally by the HostMetadataItem, HostInterfaceltem or HostnameItem parameters.

Default: 0
 Values: 0 - disabled, 1 - enabled

PluginSocket

The path to the UNIX socket for loadable plugin communications.

Default: /tmp/agent.plugin.sock

PluginTimeout

The timeout for connections with loadable plugins, in seconds.

Default: Timeout
 Range: 1-30

RefreshActiveChecks

How often the list of active checks is refreshed, in seconds. Note that after failing to refresh active checks the next refresh will be attempted in 60 seconds.

Default: 5
 Range: 1-86400

Server

A list of comma-delimited IP addresses, optionally in CIDR notation, or DNS names of Zabbix servers or Zabbix proxies. Incoming connections will be accepted only from the hosts listed here. If IPv6 support is enabled then '127.0.0.1', '::127.0.0.1', '::ffff:127.0.0.1' are treated equally and ':::0' will allow any IPv4 or IPv6 address. '0.0.0.0/0' can be used to allow any IPv4 address. Spaces are allowed.

Example:

```
Server=127.0.0.1,192.168.1.0/24,::1,2001:db8::/32,zabbix.example.com
```

Mandatory: yes

ServerActive

The Zabbix server/proxy address or cluster configuration to get active checks from. The server/proxy address is an IP address or DNS name and optional port separated by colon.
The cluster configuration is one or more server addresses separated by semicolon. Multiple Zabbix servers/clusters and Zabbix proxies can be specified, separated by comma. More than one Zabbix proxy should not be specified from each Zabbix server/cluster. If a Zabbix proxy is specified then Zabbix server/cluster for that proxy should not be specified.
Multiple comma-delimited addresses can be provided to use several independent Zabbix servers in parallel. Spaces are allowed.
If the port is not specified, default port is used.
IPv6 addresses must be enclosed in square brackets if port for that host is specified. If port is not specified, square brackets for IPv6 addresses are optional.
If this parameter is not specified, active checks are disabled.

Example for Zabbix proxy:

```
ServerActive=127.0.0.1:10051
```

Example for multiple servers:

```
ServerActive=127.0.0.1:20051,zabbix.domain,[::1]:30051,::1,[12fc::1]
```

Example for high availability:

```
ServerActive=zabbix.cluster.node1;zabbix.cluster.node2:20051;zabbix.cluster.node3
```

Example for high availability with two clusters and one server:

```
ServerActive=zabbix.cluster.node1;zabbix.cluster.node2:20051,zabbix.cluster2.node1;zabbix.cluster2.node2,z
```

SourceIP

The source IP address for:
- outgoing connections to Zabbix server or Zabbix proxy;
- making connections while executing some items (web.page.get, net.tcp.port, etc.).

StatusPort

If set, the agent will listen on this port for HTTP status requests (http://localhost:<port>/status).

Range: 1024-32767

Timeout

Specifies how long to wait (in seconds) for establishing connection and exchanging data with Zabbix proxy or server.
 This parameter defines the duration of various operations, including:
- awaiting a response from the Zabbix server;
- sending requests to Zabbix server, including **active checks** configuration requests and item data;
- retrieving log data through logfile or Windows event log monitoring;
- sending heartbeat messages;
- maximum duration for `vfs.*` checks;
- serving as a fallback in scenarios where a server or proxy older than version 7.0 sends checks without timeouts.

Default: 3
 Range: 1-30

TLSAccept

The incoming connections to accept. Used for passive checks. Multiple values can be specified, separated by comma:
unencrypted - accept connections without encryption (default)
psk - accept connections with TLS and a pre-shared key (PSK)
cert - accept connections with TLS and a certificate

Mandatory: yes, if TLS certificate or PSK parameters are defined (even for *unencrypted* connection); otherwise no

TLSCAFile

The full pathname of the file containing the top-level CA(s) certificates for peer certificate verification, used for encrypted communications between Zabbix components.

TLSCertFile

The full pathname of the file containing the agent certificate or certificate chain, used for encrypted communications with Zabbix components.

TLSCipherAll

The OpenSSL cipher string (TLS 1.2). Override the default ciphersuite selection criteria for certificate- and PSK-based encryption.

Example:

```
EECDH+aRSA+AES128:RSA+aRSA+AES128:kECDHEPSK+AES128:kPSK+AES128
```

TLSCipherAll13

The OpenSSL cipher string (TLS 1.3) for OpenSSL 1.1.1 or newer. Override the default ciphersuite selection criteria for certificate- and PSK-based encryption.

Example:

```
TLS_AES_256_GCM_SHA384:TLS_CHACHA20_POLY1305_SHA256:TLS_AES_128_GCM_SHA256
```

TLSCipherCert

The OpenSSL cipher string (TLS 1.2). Override the default ciphersuite selection criteria for certificate-based encryption.

Example:

```
EECDH+aRSA+AES128:RSA+aRSA+AES128
```

Note that this parameter cannot be used together with `TLSCipherCert,psk`; for certificate connection (`TLSCipherCert,cert`) use `TLSCipherAll` instead.

TLSCipherCert13

The OpenSSL cipher string (TLS 1.3) for OpenSSL 1.1.1 or newer. Override the default ciphersuite selection criteria for certificate-based encryption.

Note that this parameter cannot be used together with `TLSCipherCert,psk`; for certificate connection (`TLSCipherCert,cert`) use `TLSCipherAll13` instead.

TLSCipherPSK

The OpenSSL cipher string (TLS 1.2). Override the default ciphersuite selection criteria for PSK-based encryption.

Example:

```
kECDHEPSK+AES128:kPSK+AES128
```

TLSCipherPSK13

The OpenSSL cipher string (TLS 1.3) for OpenSSL 1.1.1 or newer. Override the default ciphersuite selection criteria for PSK-based encryption.

Example:

```
TLS_CHACHA20_POLY1305_SHA256:TLS_AES_128_GCM_SHA256
```

TLSCipherPSK13

How the agent should connect to Zabbix server or proxy. Used for active checks. Only one value can be specified:
unencrypted - connect without encryption (default)
psk - connect using TLS and a pre-shared key (PSK)
cert - connect using TLS and a certificate

Mandatory: yes, if TLS certificate or PSK parameters are defined (even for *unencrypted* connection); otherwise no

TLSCRLFile

The full pathname of the file containing revoked certificates. This parameter is used for encrypted communications between Zabbix components.

TLSCertFile

The full pathname of the file containing the agent private key, used for encrypted communications between Zabbix components.

TLSPSKFile

The full pathname of the file containing the agent pre-shared key, used for encrypted communications with Zabbix server.

TLSPSKIdentity

The pre-shared key identity string, used for encrypted communications with Zabbix server.

TLSServerCertIssuer

The allowed server (proxy) certificate issuer.

TLSServerCertSubject

The allowed server (proxy) certificate subject.

UnsafeUserParameters

Allow all characters to be passed in arguments to user-defined parameters. The following characters are not allowed: \ ' " ' * ? [] { } ~ \$! & ; () < > | # @
Additionally, newline characters are not allowed.

Default: 0
 Values: 0 - do not allow, 1 - allow

UserParameter

A user-defined parameter to monitor. There can be several user-defined parameters.
Format: UserParameter=<key>,<shell command>
Note that the shell command must not return empty string or EOL only. Shell commands may have relative paths, if the UserParameterDir parameter is specified.

Example:

```
UserParameter=system.test,who|wc -l
UserParameter=check_cpu,./custom_script.sh
```

UserParameterDir

The default search path for UserParameter commands. If used, the agent will change its working directory to the one specified here before executing a command. Thereby, UserParameter commands can have a relative ./ prefix instead of a full path.
Only one entry is allowed.

Example:

```
UserParameterDir=/opt/myscripts
```

5 Zabbix agent (Windows)

Overview

The parameters supported by the Windows Zabbix agent configuration file (zabbix_agentd.conf) are listed in this section.

The parameters are listed without additional information. Click on the parameter to see the full details.

Parameter	Description
Alias	Sets an alias for an item key.
AllowKey	Allow the execution of those item keys that match a pattern.
BufferSend	Do not keep data longer than N seconds in buffer.
BufferSize	The maximum number of values in the memory buffer.
DebugLevel	The debug level.
DenyKey	Deny the execution of those item keys that match a pattern.
EnableRemoteCommands	Whether remote commands from Zabbix server are allowed.
HeartbeatFrequency	The frequency of heartbeat messages in seconds.
HostInterface	An optional parameter that defines the host interface.
HostInterfaceItem	An optional parameter that defines an item used for getting the host interface.
HostMetadata	An optional parameter that defines the host metadata.
HostMetadataItem	An optional parameter that defines a Zabbix agent item used for getting the host metadata.
Hostname	An optional parameter that defines the hostname.
HostnameItem	An optional parameter that defines a Zabbix agent item used for getting the hostname.
Include	You may include individual files or all files in a directory in the configuration file.
ListenBacklog	The maximum number of pending connections in the TCP queue.
ListenIP	A list of comma-delimited IP addresses that the agent should listen on.
ListenPort	The agent will listen on this port for connections from the server.
LogFile	The name of the log file.
LogFileSize	The maximum size of the log file.
LogRemoteCommands	Enable logging of executed shell commands as warnings.
LogType	The type of the log output.
MaxLinesPerSecond	The maximum number of new lines the agent will send per second to Zabbix server or proxy when processing 'log' and 'logrt' active checks.

Parameter	Description
PerfCounter	Defines a new parameter <parameter_name> which is the average value for system performance counter <perf_counter_path> for the specified time period <period> (in seconds).
PerfCounterEn	Defines a new parameter <parameter_name> which is the average value for system performance counter <perf_counter_path> for the specified time period <period> (in seconds). Compared to PerfCounter, the perfcounter paths must be in English.
RefreshActiveChecks Server	How often the list of active checks is refreshed. A list of comma-delimited IP addresses, optionally in CIDR notation, or DNS names of Zabbix servers and Zabbix proxies.
ServerActive	The Zabbix server/proxy address or cluster configuration to get active checks from.
SourceIP	The source IP address.
StartAgents	The number of pre-forked instances of zabbix_agentd that process passive checks.
Timeout	Specifies how long to wait (in seconds) for establishing connection and exchanging data with Zabbix proxy or server.
TLSAccept	What incoming connections to accept.
TLSCAFile	The full pathname of a file containing the top-level CA(s) certificates for peer certificate verification, used for encrypted communications between Zabbix components.
TLSCertFile	The full pathname of a file containing the agent certificate or certificate chain, used for encrypted communications between Zabbix components.
TLSConnect	How the agent should connect to Zabbix server or proxy.
TLSCRLFile	The full pathname of a file containing revoked certificates. This parameter is used for encrypted communications between Zabbix components.
TLSKeyFile	The full pathname of a file containing the agent private key, used for encrypted communications between Zabbix components.
TLSPSKFile	The full pathname of a file containing the agent pre-shared key, used for encrypted communications with Zabbix server.
TLSPSKIdentity	The pre-shared key identity string, used for encrypted communications with Zabbix server.
TLSServerCertIssuer	The allowed server (proxy) certificate issuer.
TLSServerCertSubject	The allowed server (proxy) certificate subject.
UnsafeUserParameters	Allow all characters to be passed in arguments to user-defined parameters.
UserParameter	A user-defined parameter to monitor.
UserParameterDir	The default search path for UserParameter commands.

All parameters are non-mandatory unless explicitly stated that the parameter is mandatory.

Note that:

- The default values reflect daemon defaults, not the values in the shipped configuration files;
- Values support **environment variables**;
- Zabbix supports configuration files only in UTF-8 encoding without **BOM**;
- Comments starting with **"#"** are only supported in the beginning of the line.

Parameter details

Alias

Sets an alias for an item key. It can be used to substitute a long and complex item key with a shorter and simpler one.
Multiple *Alias* parameters may be present. Multiple parameters with the same *Alias* key are not allowed.
Different *Alias* keys may reference the same item key.
Aliases can be used in *HostMetadataItem* but not in *HostnameItem* or *PerfCounter* parameter.

Example 1: Retrieving the paging file usage in percentage from the server.

```
Alias=pg_usage:perf_counter[\Paging File(_Total)\% Usage]
```

Now the shorthand key **pg_usage** may be used to retrieve data.

Example 2: Getting the CPU load with default and custom parameters.

```
Alias=cpu.load:system.cpu.load
Alias=cpu.load[*]:system.cpu.load[*]
```

This allows use **cpu.load** key to get the CPU load with default parameters as well as use **cpu.load[percpu,avg15]** to get specific data about the CPU load.

Example 3: Running multiple **low-level discovery** rules processing the same discovery items.

```
Alias=vfs.fs.discovery[*]:vfs.fs.discovery
```

Now it is possible to set up several discovery rules using **vfs.fs.discovery** with different parameters for each rule, e.g., **vfs.fs.discovery[foo]**, **vfs.fs.discovery[bar]**, etc.

AllowKey

Allow the execution of those item keys that match a pattern. The key pattern is a wildcard expression that supports the "*" character to match any number of any characters.
Multiple key matching rules may be defined in combination with DenyKey. The parameters are processed one by one according to their appearance order. See also: [Restricting agent checks](#).

BufferSend

Do not keep data longer than N seconds in buffer.

Default: 5
 Range: 1-3600

BufferSize

The maximum number of values in the memory buffer. The agent will send all collected data to the Zabbix server or proxy if the buffer is full.

Default: 100
 Range: 2-65535

DebugLevel

Specify the debug level:
0 - basic information about starting and stopping of Zabbix processes
1 - critical information;
2 - error information;
3 - warnings;
4 - for debugging (produces lots of information);
5 - extended debugging (produces even more information).

Default: 3
 Range: 0-5

DenyKey

Deny the execution of those item keys that match a pattern. The key pattern is a wildcard expression that supports the "*" character to match any number of any characters.
Multiple key matching rules may be defined in combination with AllowKey. The parameters are processed one by one according to their appearance order. See also: [Restricting agent checks](#).

EnableRemoteCommands

Whether remote commands from Zabbix server are allowed. This parameter is **deprecated**, use AllowKey=system.run[*] or DenyKey=system.run[*] instead.
It is an internal alias for AllowKey/DenyKey parameters depending on value:
0 - DenyKey=system.run[*]
1 - AllowKey=system.run[*]

Default: 0
 Values: 0 - do not allow, 1 - allow

HeartbeatFrequency

The frequency of heartbeat messages in seconds. Used for monitoring the availability of active checks.
0 - heartbeat messages disabled.

Default: 60
 Range: 0-3600

HostInterface

An optional parameter that defines the host interface. The host interface is used at host [autoregistration](#) process. If not defined, the value will be acquired from HostInterfaceItem.
The agent will issue an error and not start if the value is over the limit of 255 characters.

Range: 0-255 characters

HostInterfaceItem

An optional parameter that defines an item used for getting the host interface.
Host interface is used at host [autoregistration](#) process.
During an autoregistration request the agent will log a warning message if the value returned by the specified item is over the limit of 255 characters.
The [system.run\[\]](#) item is supported regardless of AllowKey/DenyKey values.
This option is only used when HostInterface is not defined.

HostMetadata

An optional parameter that defines host metadata. Host metadata is used only at host autoregistration process (active agent). If not defined, the value will be acquired from HostMetadataItem.
The agent will issue an error and not start if the specified value is over the limit of 2034 bytes or a non-UTF-8 string.

Range: 0-2034 bytes

HostMetadataItem

An optional parameter that defines a Zabbix agent item used for getting host metadata. This option is only used when HostMetadata is not defined. User parameters, performance counters and aliases are supported. The `system.run[]` item is supported regardless of AllowKey/DenyKey values.
The HostMetadataItem value is retrieved on each autoregistration attempt and is used only at host autoregistration process (active agent).
During an autoregistration request the agent will log a warning message if the value returned by the specified item is over the limit of 65535 UTF-8 code points. The value returned by the item must be a UTF-8 string otherwise it will be ignored.

Hostname

A list of comma-delimited, unique, case-sensitive hostnames. Required for active checks and must match hostnames as configured on the server. The value is acquired from HostnameItem if undefined.
Allowed characters: alphanumeric, '.', '_', and '-'. Maximum length: 128 characters per hostname, 2048 characters for the entire line.

Default: Set by HostnameItem

HostnameItem

An optional parameter that defines a Zabbix agent item used for getting the host name. This option is only used when Hostname is not defined. User parameters, performance counters or aliases are not supported, but the `system.run[]` item is supported regardless of AllowKey/DenyKey values.
See also a [more detailed description](#).

Default: `system.hostname`

Include

You may include individual files or all files in a directory in the configuration file (located in `C:\Program Files\Zabbix Agent` by default if Zabbix agent is installed using Windows MSI installer packages; located in the folder specified during installation if Zabbix agent is installed as a zip archive). All included files must have correct syntax, otherwise agent will not start.
To only include relevant files in the specified directory, the asterisk wildcard character is supported for pattern matching.
See [special notes](#) about limitations.

Example:

```
Include=C:\Program Files\Zabbix Agent\zabbix_agentd.d\*.conf
```

ListenBacklog

The maximum number of pending connections in the TCP queue.
The default value is a hard-coded constant, which depends on the system.
The maximum supported value depends on the system, too high values may be silently truncated to the 'implementation-specified maximum'.

Default: `SOMAXCONN`
 Range: 0 - `INT_MAX`

ListenIP

A list of comma-delimited IP addresses that the agent should listen on.

Default: `0.0.0.0`

ListenPort

The agent will listen on this port for connections from the server.

Default: `10050`
 Range: 1024-32767

LogFile

The name of the agent log file.

Default: `C:\zabbix_agentd.log`
 Mandatory: Yes, if LogType is set to *file*; otherwise no

LogFileSize

The maximum size of a log file in MB.
0 - disable automatic log rotation.
Note: If the log file size limit is reached and file rotation fails, for whatever reason, the existing log file is truncated and started anew.

Default: `1`
 Range: 0-1024

LogRemoteCommands

Enable the logging of the executed shell commands as warnings. Commands will be logged only if executed remotely. Log entries will not be created if `system.run[]` is launched locally by HostMetadataItem, HostInterfaceItem or HostnameItem parameters.

Default: `0`
 Values: 0 - disabled, 1 - enabled

LogType

The type of the log output:
file - write log to the file specified by LogFile parameter;
system - write log to Windows Event Log;
console - write log to standard output.

Default: file

MaxLinesPerSecond

The maximum number of new lines the agent will send per second to Zabbix server or proxy when processing 'log', 'logrt', and 'eventlog' active checks. The provided value will be overridden by the 'maxlines' parameter, provided in the 'log', 'logrt', or 'eventlog' item key.
Note: Zabbix will process 10 times more new lines than set in *MaxLinesPerSecond* to seek the required string in log items.

Default: 20
 Range: 1-1000

PerfCounter

Defines a new parameter <parameter_name> which is the average value for system performance counter <perf_counter_path> for the specified time period <period> (in seconds).
Syntax: <parameter_name>,"<perf_counter_path>",<period>

For example, if you wish to receive the average number of processor interrupts per second for the last minute, you can define a new parameter "interrupts" as the following:

```
PerfCounter = interrupts,"\Processor(0)\Interrupts/sec",60
```

Please note the double quotes around the performance counter path. The parameter name (interrupts) is to be used as the item key when creating an item. Samples for calculating the average value will be taken every second.
You may run "typeperf -qx" to get the list of all performance counters available in Windows.

PerfCounterEn

Defines a new parameter <parameter_name> which is the average value for system performance counter <perf_counter_path> for the specified time period <period> (in seconds). Compared to PerfCounter, the perfcounter paths must be in English. Supported only on **Windows Server 2008/Vista** and later.
Syntax: <parameter_name>,"<perf_counter_path>",<period>

For example, if you wish to receive the average number of processor interrupts per second for the last minute, you can define a new parameter "interrupts" as the following:

```
PerfCounterEn = interrupts,"\Processor(0)\Interrupts/sec",60
```

Please note the double quotes around the performance counter path. The parameter name (interrupts) is to be used as the item key when creating an item. Samples for calculating the average value will be taken every second.
You can find the list of English strings by viewing the following registry key: HKEY_LOCAL_MACHINE\SOFTWARE\Microsoft\Windows NT\CurrentVersion\Perflib\009.

RefreshActiveChecks

How often the list of active checks is refreshed, in seconds. Note that after failing to refresh active checks the next refresh will be attempted in 60 seconds.

Default: 5
 Range: 1-86400

Server

A list of comma-delimited IP addresses, optionally in CIDR notation, or DNS names of Zabbix servers or Zabbix proxies. Incoming connections will be accepted only from the hosts listed here. If IPv6 support is enabled then '127.0.0.1', '::127.0.0.1', '::ffff:127.0.0.1' are treated equally and ':::0' will allow any IPv4 or IPv6 address. '0.0.0.0/0' can be used to allow any IPv4 address. Note that "IPv4-compatible IPv6 addresses" (0000::/96 prefix) are supported but deprecated by [RFC4291](#). Spaces are allowed.

Example:

```
Server=127.0.0.1,192.168.1.0/24,:::1,2001:db8::/32,zabbix.example.com
```

Mandatory: yes, if StartAgents is not explicitly set to 0

ServerActive

The Zabbix server/proxy address or cluster configuration to get active checks from. The server/proxy address is an IP address or DNS name and optional port separated by colon.
The cluster configuration is one or more server addresses separated by semicolon. Multiple Zabbix servers/clusters and Zabbix proxies can be specified, separated by comma. More than one Zabbix proxy should not be specified from each Zabbix server/cluster. If Zabbix proxy is specified then Zabbix server/cluster for that proxy should not be specified.
Multiple comma-delimited addresses can be provided to use several independent Zabbix servers in parallel. Spaces are allowed.
If the port is not specified, default port is used.
IPv6 addresses must be enclosed in square brackets if port for that host is specified. If port is not specified, square brackets for IPv6 addresses are optional.
If this parameter is not specified, active checks are disabled.

Example for Zabbix proxy:

```
ServerActive=127.0.0.1:10051
```

Example for multiple servers:

```
ServerActive=127.0.0.1:20051,zabbix.domain,[::1]:30051,::1,[12fc::1]
```

Example for high availability:

```
ServerActive=zabbix.cluster.node1;zabbix.cluster.node2:20051;zabbix.cluster.node3
```

Example for high availability with two clusters and one server:

```
ServerActive=zabbix.cluster.node1;zabbix.cluster.node2:20051,zabbix.cluster2.node1;zabbix.cluster2.node2,z
```

Range: (*)

SourceIP

The source IP address for:
- outgoing connections to Zabbix server or Zabbix proxy;
- making connections while executing some items (web.page.get, net.tcp.port, etc.).

StartAgents

The number of pre-forked instances of zabbix_agentd that process passive checks. If set to 0, passive checks are disabled and the agent will not listen on any TCP port.

Default: 10
 Range: 0-63 (*)

Timeout

Specifies how long to wait (in seconds) for establishing connection and exchanging data with Zabbix proxy or server.
 This parameter is used for defining the duration of various operations:
 - awaiting a response from Zabbix server;
 - sending requests to Zabbix server, including **active checks** configuration requests and item data;
 - retrieving log data through logfile or Windows event log monitoring;
 - sending heartbeat messages;
 - maximum duration of **vfs.** checks;
 - used by Zabbix agent modules;
 - also used as a fallback in scenarios where server/proxy older than version 7.0 is sending checks without timeouts.

Default: 3
 Range: 1-30

TLSAccept

The incoming connections to accept. Used for passive checks. Multiple values can be specified, separated by comma:
unencrypted - accept connections without encryption (default)
psk - accept connections with TLS and a pre-shared key (PSK)
cert - accept connections with TLS and a certificate

Mandatory: yes, if TLS certificate or PSK parameters are defined (even for *unencrypted* connection); otherwise no

TLSCAFile

The full pathname of the file containing the top-level CA(s) certificates for peer certificate verification, used for encrypted communications between Zabbix components.

TLSCertFile

The full pathname of the file containing the agent certificate or certificate chain, used for encrypted communications with Zabbix components.

TLSConnect

How the agent should connect to Zabbix server or proxy. Used for active checks. Only one value can be specified:
unencrypted - connect without encryption (default)
psk - connect using TLS and a pre-shared key (PSK)
cert - connect using TLS and a certificate

Mandatory: yes, if TLS certificate or PSK parameters are defined (even for *unencrypted* connection); otherwise no

TLSCRLFile

The full pathname of the file containing revoked certificates. This parameter is used for encrypted communications between Zabbix components.

TLSKeyFile

The full pathname of the file containing the agent private key, used for encrypted communications between Zabbix components.

TLSPSKFile

The full pathname of the file containing the agent pre-shared key, used for encrypted communications with Zabbix server.

TLSPSKIdentity

The pre-shared key identity string, used for encrypted communications with Zabbix server.

TLSServerCertIssuer

The allowed server (proxy) certificate issuer.

TLSServerCertSubject

The allowed server (proxy) certificate subject.

UnsafeUserParameters

Allow all characters to be passed in arguments to user-defined parameters. The following characters are not allowed: \ ' " ' * ? [] { } ~ \$! & ; () < > | # @
Additionally, newline characters are not allowed.

Default: 0
 Values: 0 - do not allow, 1 - allow

UserParameter

A user-defined parameter to monitor. There can be several user-defined parameters.
Format: UserParameter=<key>,<shell command>
Note that the shell command must not return empty string or EOL only. Shell commands may have relative paths, if the UserParameterDir parameter is specified.

Example:

```
UserParameter=system.test,who|wc -l  
UserParameter=check_cpu,./custom_script.sh
```

UserParameterDir

The default search path for UserParameter commands. If used, the agent will change its working directory to the one specified here before executing a command. Thereby, UserParameter commands can have a relative ./ prefix instead of a full path. Only one entry is allowed.

Example:

```
UserParameterDir=/opt/myscripts
```

Note:

(*) The number of active servers listed in ServerActive plus the number of pre-forked instances for passive checks specified in StartAgents must be less than 64.

See also

1. [Differences in the Zabbix agent configuration for active and passive checks starting from version 2.0.0.](#)

6 Zabbix agent 2 (Windows)

Overview

Zabbix agent 2 is a new generation of Zabbix agent and may be used in place of Zabbix agent.

The parameters supported by the Windows Zabbix agent 2 configuration file (zabbix_agent2.conf) are listed in this section.

The parameters are listed without additional information. Click on the parameter to see the full details.

Parameter	Description
Alias	Sets an alias for an item key.
AllowKey	Allow the execution of those item keys that match a pattern.
BufferSend	Do not keep data longer than N seconds in buffer.
BufferSize	The maximum number of values in the memory buffer.
ControlSocket	The control socket, used to send runtime commands with the '-R' option.
DebugLevel	The debug level.
DenyKey	Deny the execution of those item keys that match a pattern.
EnablePersistentBuffer	Enable the usage of local persistent storage for active items.
ForceActiveChecksOnStart	Perform active checks immediately after the restart for the first received configuration.
HeartbeatFrequency	The frequency of heartbeat messages in seconds.
HostInterface	An optional parameter that defines the host interface.
HostInterfaceltem	An optional parameter that defines an item used for getting the host interface.

Parameter	Description
HostMetadata	An optional parameter that defines the host metadata.
HostMetadataItem	An optional parameter that defines a Zabbix agent item used for getting the host metadata.
Hostname	An optional parameter that defines the hostname.
HostnameItem	An optional parameter that defines a Zabbix agent item used for getting the hostname.
Include	You may include individual files or all files in a directory in the configuration file.
ListenIP	A list of comma-delimited IP addresses that the agent should listen on.
ListenPort	The agent will listen on this port for connections from the server.
LogFile	The name of the log file.
LogFileSize	The maximum size of the log file.
LogType	The type of the log output.
PersistentBufferFile	The file where Zabbix agent 2 should keep the SQLite database.
PersistentBufferPeriod	The time period for which data should be stored when there is no connection to the server or proxy.
Plugins.<PluginName>.SystemCapacity	The number of checks per plugin that can be executed at the same time.
Plugins.Log.MaxLinesPerSecond	The maximum number of new lines the agent will send per second to Zabbix server or proxy when processing 'log' and 'logrt' active checks.
Plugins.SystemRun.LogRemote	Enable the logging of the executed shell commands as warnings.
PluginSocket	The path to the UNIX socket for loadable plugin communications.
PluginTimeout	The timeout for connections with loadable plugins, in seconds.
RefreshActiveChecks	How often the list of active checks is refreshed.
Server	A list of comma-delimited IP addresses, optionally in CIDR notation, or DNS names of Zabbix servers and Zabbix proxies.
ServerActive	The Zabbix server/proxy address or cluster configuration to get active checks from.
SourceIP	The source IP address.
StatusPort	If set, the agent will listen on this port for HTTP status requests (<a href="http://localhost:<port>/status">http://localhost:<port>/status).
Timeout	Specifies how long to wait (in seconds) for establishing connection and exchanging data with Zabbix proxy or server.
TLSAccept	What incoming connections to accept.
TLSCAFile	The full pathname of a file containing the top-level CA(s) certificates for peer certificate verification, used for encrypted communications between Zabbix components.
TLSCertFile	The full pathname of a file containing the agent certificate or certificate chain, used for encrypted communications between Zabbix components.
TLSCipherAll13	The OpenSSL cipher string (TLS 1.3). Override the default ciphersuite selection criteria for certificate- and PSK-based encryption.
TLSCipherCert13	The OpenSSL cipher string (TLS 1.3). Override the default ciphersuite selection criteria for certificate-based encryption.
TLSCipherPSK13	The OpenSSL cipher string (TLS 1.3). Override the default ciphersuite selection criteria for PSK-based encryption.
TLSConnect	How the agent should connect to Zabbix server or proxy.
TLSCTRLFile	The full pathname of a file containing revoked certificates. This parameter is used for encrypted communications between Zabbix components.
TLSKeyFile	The full pathname of a file containing the agent private key, used for encrypted communications between Zabbix components.
TLSPSKFile	The full pathname of a file containing the agent pre-shared key, used for encrypted communications with Zabbix server.
TLSPSKIdentity	The pre-shared key identity string, used for encrypted communications with Zabbix server.
TLSServerCertIssuer	The allowed server (proxy) certificate issuer.
TLSServerCertSubject	The allowed server (proxy) certificate subject.
UnsafeUserParameters	Allow all characters to be passed in arguments to user-defined parameters.
UserParameter	A user-defined parameter to monitor.
UserParameterDir	The default search path for UserParameter commands.

All parameters are non-mandatory unless explicitly stated that the parameter is mandatory.

Note that:

- The default values reflect process defaults, not the values in the shipped configuration files;
- Values support **environment variables**;
- Zabbix supports configuration files only in UTF-8 encoding without **BOM**;
- Comments starting with "**#**" are only supported in the beginning of the line.

Parameter details

Alias

Sets an alias for an item key. It can be used to substitute a long and complex item key with a shorter and simpler one.
Multiple *Alias* parameters may be present. Multiple parameters with the same *Alias* key are not allowed.
Different *Alias* keys may reference the same item key.
Aliases can be used in *HostMetadataItem* but not in the *HostnameItem* parameter.

Example 1: Retrieving the paging file usage in percentage from the server.

```
Alias=pg_usage:perf_counter[\Paging File(_Total)\% Usage]
```

Now the shorthand key **pg_usage** may be used to retrieve data.

Example 2: Getting the CPU load with default and custom parameters.

```
Alias=cpu.load:system.cpu.load  
Alias=cpu.load[*]:system.cpu.load[*]
```

This allows use **cpu.load** key to get the CPU load with default parameters as well as use **cpu.load[percpu,avg15]** to get specific data about the CPU load.

Example 3: Running multiple **low-level discovery** rules processing the same discovery items.

```
Alias=vfs.fs.discovery[*]:vfs.fs.discovery
```

Now it is possible to set up several discovery rules using **vfs.fs.discovery** with different parameters for each rule, e.g., **vfs.fs.discovery[foo]**, **vfs.fs.discovery[bar]**, etc.

AllowKey

Allow the execution of those item keys that match a pattern. The key pattern is a wildcard expression that supports the "*" character to match any number of any characters.
Multiple key matching rules may be defined in combination with DenyKey. The parameters are processed one by one according to their appearance order. See also: [Restricting agent checks](#).

BufferSend

The time interval in seconds which determines how often values are sent from the buffer to Zabbix server.
Note that if the buffer is full, the data will be sent sooner.

Default: 5
 Range: 1-3600

BufferSize

The maximum number of values in the memory buffer. The agent will send all collected data to the Zabbix server or proxy if the buffer is full.
This parameter should only be used if persistent buffer is disabled (*EnablePersistentBuffer=0*).

Default: 1000
 Range: 2-65535

ControlSocket

The control socket, used to send runtime commands with the '-R' option.

Default: \\.\pipe\agent.sock

DebugLevel

Specify the debug level:
0 - basic information about starting and stopping of Zabbix processes
1 - critical information;
2 - error information;
3 - warnings;
4 - for debugging (produces lots of information);
5 - extended debugging (produces even more information).

Default: 3
 Range: 0-5

DenyKey

Deny the execution of those item keys that match a pattern. The key pattern is a wildcard expression that supports the "*" character to match any number of any characters.
Multiple key matching rules may be defined in combination with AllowKey. The parameters are processed one by one according to their appearance order. See also: [Restricting agent checks](#).

EnablePersistentBuffer

Enable the usage of local persistent storage for active items. If persistent storage is disabled, the memory buffer will be used.

Default: 0
 Values: 0 - disabled, 1 - enabled

ForceActiveChecksOnStart

Perform active checks immediately after the restart for the first received configuration. Also available as a per-plugin configuration parameter, for example: `Plugins.Uptime.System.ForceActiveChecksOnStart=1`

Default: 0
 Values: 0 - disabled, 1 - enabled

HeartbeatFrequency

The frequency of heartbeat messages in seconds. Used for monitoring the availability of active checks.
0 - heartbeat messages disabled.

Default: 60
 Range: 0-3600

HostInterface

An optional parameter that defines the host interface. The host interface is used at host **autoregistration** process. If not defined, the value will be acquired from HostInterfaceItem.
The agent will issue an error and not start if the value is over the limit of 255 characters.

Range: 0-255 characters

HostInterfaceItem

An optional parameter that defines an item used for getting the host interface.
Host interface is used at host **autoregistration** process. This option is only used when HostInterface is not defined.
The **system.run[]** item is supported regardless of AllowKey/DenyKey values.
During an autoregistration request the agent will log a warning message if the value returned by the specified item is over the limit of 255 characters.

HostMetadata

An optional parameter that defines host metadata. Host metadata is used only at host autoregistration process (active agent). If not defined, the value will be acquired from HostMetadataItem.
The agent will issue an error and not start if the specified value is over the limit of 2034 bytes or a non-UTF-8 string.

Range: 0-2034 bytes

HostMetadataItem

An optional parameter that defines an item used for getting host metadata. This option is only used when HostMetadata is not defined. User parameters and aliases are supported. The **system.run[]** item is supported regardless of AllowKey/DenyKey values.
The HostMetadataItem value is retrieved on each autoregistration attempt and is used only at host autoregistration process.
During an autoregistration request the agent will log a warning message if the value returned by the specified item is over the limit of 65535 UTF-8 code points. The value returned by the item must be a UTF-8 string otherwise it will be ignored.

Hostname

A list of comma-delimited, unique, case-sensitive hostnames. Required for active checks and must match hostnames as configured on the server. The value is acquired from HostnameItem if undefined.
Allowed characters: alphanumeric, '.', '_', and '-'. Maximum length: 128 characters per hostname, 2048 characters for the entire line.

Default: Set by HostnameItem

HostnameItem

An optional parameter that defines an item used for getting the host name. This option is only used when Hostname is not defined. User parameters or aliases are not supported, but the **system.run[]** item is supported regardless of AllowKey/DenyKey values.

Default: `system.hostname`

Include

You may include individual files or all files in a directory in the configuration file (located in C:\Program Files\Zabbix Agent 2 by default if Zabbix agent is installed using Windows MSI installer packages; located in the folder specified during installation if Zabbix agent is installed as a zip archive). All included files must have correct syntax, otherwise agent will not start. The path can be relative to the `zabbix_agent2.conf` file location (e.g., `Include=. \zabbix_agent2.d\plugins.d*.conf`).
To only include relevant files in the specified directory, the asterisk wildcard character is supported for pattern matching.
See **special notes** about limitations.

Example:

```
Include=C:\Program Files\Zabbix Agent2\zabbix_agent2.d\*.conf
```

ListenIP

A list of comma-delimited IP addresses that the agent should listen on. The first IP address is sent to the Zabbix server, if connecting to it, to retrieve the list of active checks.

Default: 0.0.0.0

ListenPort

The agent will listen on this port for connections from the server.

Default: 10050
 Range: 1024-32767

LogFile

The name of the agent log file.

Default: c:\zabbix_agent2.log
 Mandatory: Yes, if LogType is set to *file*; otherwise no

LogFileSize

The maximum size of a log file in MB.
0 - disable automatic log rotation.
Note: If the log file size limit is reached and file rotation fails, for whatever reason, the existing log file is truncated and started anew.

Default: 1
 Range: 0-1024

LogType

The type of the log output:
file - write log to the file specified by LogFile parameter;
console - write log to standard output.

Default: *file*

PersistentBufferFile

The file where Zabbix agent 2 should keep the SQLite database. Must be a full filename. This parameter is only used if persistent buffer is enabled (*EnablePersistentBuffer=1*).

PersistentBufferPeriod

The time period for which data should be stored when there is no connection to the server or proxy. Older data will be lost. Log data will be preserved. This parameter is only used if persistent buffer is enabled (*EnablePersistentBuffer=1*).

Default: 1h
 Range: 1m-365d

Plugins.<PluginName>.System.Capacity

The limit of checks per <PluginName> plugin that can be executed at the same time.

Default: 1000 Range: 1-1000

Plugins.Log.MaxLinesPerSecond

The maximum number of new lines the agent will send per second to Zabbix server or proxy when processing 'log', 'logrt' and 'eventlog' active checks. The provided value will be overridden by the 'maxlines' parameter, provided in the 'log', 'logrt' or 'eventlog' item key.
Note: Zabbix will process 10 times more new lines than set in *MaxLinesPerSecond* to seek the required string in log items.

Default: 20
 Range: 1-1000

Plugins.SystemRun.LogRemoteCommands

Enable the logging of the executed shell commands as warnings. The commands will be logged only if executed remotely. Log entries will not be created if system.run[] is launched locally by the HostMetadataItem, HostInterfaceItem or HostnameItem parameters.

Default: 0
 Values: 0 - disabled, 1 - enabled

PluginSocket

The path to the UNIX socket for loadable plugin communications.

Default: \\.\pipe\agent.plugin.sock

PluginTimeout

The timeout for connections with loadable plugins, in seconds.

Default: Timeout
 Range: 1-30

RefreshActiveChecks

How often the list of active checks is refreshed, in seconds. Note that after failing to refresh active checks the next refresh will be attempted in 60 seconds.

Default: 5
 Range: 1-86400

Server

A list of comma-delimited IP addresses, optionally in CIDR notation, or DNS names of Zabbix servers or Zabbix proxies. Incoming connections will be accepted only from the hosts listed here. If IPv6 support is enabled then '127.0.0.1', '::127.0.0.1', '::ffff:127.0.0.1'

are treated equally and ':::0' will allow any IPv4 or IPv6 address. '0.0.0.0/0' can be used to allow any IPv4 address. Spaces are allowed.

Example:

```
Server=127.0.0.1,192.168.1.0/24,:::1,2001:db8::/32,zabbix.example.com
```

Mandatory: yes

ServerActive

The Zabbix server/proxy address or cluster configuration to get active checks from. The server/proxy address is an IP address or DNS name and optional port separated by colon.
The cluster configuration is one or more server addresses separated by semicolon. Multiple Zabbix servers/clusters and Zabbix proxies can be specified, separated by comma. More than one Zabbix proxy should not be specified from each Zabbix server/cluster. If a Zabbix proxy is specified then Zabbix server/cluster for that proxy should not be specified.
Multiple comma-delimited addresses can be provided to use several independent Zabbix servers in parallel. Spaces are allowed.
If the port is not specified, default port is used.
IPv6 addresses must be enclosed in square brackets if port for that host is specified. If port is not specified, square brackets for IPv6 addresses are optional.
If this parameter is not specified, active checks are disabled.

Example for Zabbix proxy:

```
ServerActive=127.0.0.1:10051
```

Example for multiple servers:

```
ServerActive=127.0.0.1:20051,zabbix.domain,[:::1]:30051,:::1,[12fc::1]
```

Example for high availability:

```
ServerActive=zabbix.cluster.node1;zabbix.cluster.node2:20051;zabbix.cluster.node3
```

Example for high availability with two clusters and one server:

```
ServerActive=zabbix.cluster.node1;zabbix.cluster.node2:20051,zabbix.cluster2.node1;zabbix.cluster2.node2,z
```

SourceIP

The source IP address for:
- outgoing connections to Zabbix server or Zabbix proxy;
- making connections while executing some items (web.page.get, net.tcp.port, etc.).

StatusPort

If set, the agent will listen on this port for HTTP status requests (http://localhost:<port>/status).

Range: 1024-32767

Timeout

Specifies how long to wait (in seconds) for establishing connection and exchanging data with Zabbix proxy or server.
 This parameter defines the duration of various operations, including:
 - awaiting a response from the Zabbix server;
 - sending requests to Zabbix server, including **active checks** configuration requests and item data;
 - retrieving log data through logfile or Windows event log monitoring;
 - sending heartbeat messages;
 - maximum duration for vifs.* checks;
 - serving as a fallback in scenarios where a server or proxy older than version 7.0 sends checks without timeouts.

Default: 3
 Range: 1-30

TLSAccept

The incoming connections to accept. Used for passive checks. Multiple values can be specified, separated by comma:
unencrypted - accept connections without encryption (default)
psk - accept connections with TLS and a pre-shared key (PSK)
cert - accept connections with TLS and a certificate

Mandatory: yes, if TLS certificate or PSK parameters are defined (even for *unencrypted* connection); otherwise no

TLSCAFile

The full pathname of the file containing the top-level CA(s) certificates for peer certificate verification, used for encrypted communications between Zabbix components.

TLSCertFile

The full pathname of the file containing the agent certificate or certificate chain, used for encrypted communications with Zabbix components.

TLSCipherAll13

The OpenSSL cipher string (TLS 1.3). Override the default ciphersuite selection criteria for certificate- and PSK-based encryption.

Example:

```
TLS_AES_256_GCM_SHA384:TLS_CHACHA20_POLY1305_SHA256:TLS_AES_128_GCM_SHA256
```

TLSCipherCert13

The OpenSSL cipher string (TLS 1.3). Override the default ciphersuite selection criteria for certificate-based encryption.

Note that this parameter cannot be used together with `TLSAccept=cert,psk`; for certificate connection (`TLSCConnect=cert`) use `TLSCipherAll13` instead.

TLSCipherPSK13

The OpenSSL cipher string (TLS 1.3). Override the default ciphersuite selection criteria for PSK-based encryption.

Example:

```
TLS_CHACHA20_POLY1305_SHA256:TLS_AES_128_GCM_SHA256
```

TLSCConnect

How the agent should connect to Zabbix server or proxy. Used for active checks. Only one value can be specified:
`unencrypted` - connect without encryption (default)
`psk` - connect using TLS and a pre-shared key (PSK)
`cert` - connect using TLS and a certificate

Mandatory: yes, if TLS certificate or PSK parameters are defined (even for `unencrypted` connection); otherwise no

TLSCRLFile

The full pathname of the file containing revoked certificates. This parameter is used for encrypted communications between Zabbix components.

TLSKeyFile

The full pathname of the file containing the agent private key, used for encrypted communications between Zabbix components.

TLSPSKFile

The full pathname of the file containing the agent pre-shared key, used for encrypted communications with Zabbix server.

TLSPSKIdentity

The pre-shared key identity string, used for encrypted communications with Zabbix server.

TLSServerCertIssuer

The allowed server (proxy) certificate issuer.

TLSServerCertSubject

The allowed server (proxy) certificate subject.

UnsafeUserParameters

Allow all characters to be passed in arguments to user-defined parameters. The following characters are not allowed: `\ ' " ' * ? [] { } ~ $! & ; () < > | # @`
Additionally, newline characters are not allowed.

Default: 0
Values: 0 - do not allow, 1 - allow

UserParameter

A user-defined parameter to monitor. There can be several user-defined parameters.
Format: `UserParameter=<key>,<shell command>`
Note that the shell command must not return empty string or EOL only. Shell commands may have relative paths, if the `UserParameterDir` parameter is specified.

Example:

```
UserParameter=system.test,who|wc -l  
UserParameter=check_cpu,./custom_script.sh
```

UserParameterDir

The default search path for `UserParameter` commands. If used, the agent will change its working directory to the one specified here before executing a command. Thereby, `UserParameter` commands can have a relative `./` prefix instead of a full path.
Only one entry is allowed.

Example:

```
UserParameterDir=/opt/myscripts
```

7 Zabbix agent 2 plugins

Overview

This section contains descriptions of configuration file parameters for Zabbix agent 2 plugins. Please use the sidebar to access information about the specific plugin.

1 Ceph plugin

Overview

This section lists parameters supported in the Ceph Zabbix agent 2 plugin configuration file (ceph.conf).

Note that:

- The default values reflect process defaults, not the values in the shipped configuration files;
- Values support [environment variables](#);
- Zabbix supports configuration files only in UTF-8 encoding without [BOM](#);
- Comments starting with “#” are only supported at the beginning of the line.

Parameters

Parameter	Mandatory	Range	Default	Description
Plugins.Ceph.Default.ApiKey				Default API key for connecting to Ceph; used if no value is specified in an item key or named session.
Plugins.Ceph.Default.User				Default username for connecting to Ceph; used if no value is specified in an item key or named session.
Plugins.Ceph.Default.Uri			https://localhost:8003	Default URI for connecting to Ceph; used if no value is specified in an item key or named session. Should not include embedded credentials (they will be ignored). Must match the URI format. Only https scheme is supported; a scheme can be omitted. A port can be omitted (default=8003). Examples: https://127.0.0.1:8003 localhost
Plugins.Ceph.InsecureSkipVerify		false / true	false	Determines whether an http client should verify the server's certificate chain and host name. If true, TLS accepts any certificate presented by the server and any host name in that certificate. In this mode, TLS is susceptible to man-in-the-middle attacks (should be used only for testing).
Plugins.Ceph.KeepAlive		60-900	300	The maximum time of waiting (in seconds) before unused plugin connections are closed.
Plugins.Ceph.Sessions.<SessionName>.ApiKey				Named session API key. <SessionName> - define name of a session for using in item keys.
Plugins.Ceph.Sessions.<SessionName>.User				Named session username. <SessionName> - define name of a session for using in item keys.
Plugins.Ceph.Sessions.<SessionName>.Uri				Connection string of a named session. <SessionName> - define name of a session for using in item keys. Should not include embedded credentials (they will be ignored). Must match the URI format. Only https scheme is supported; a scheme can be omitted. A port can be omitted (default=8003). Examples: https://127.0.0.1:8003 localhost

Parameter	Mandatory	Range	Default	Description
Plugins.Ceph.Timeout		1-30	global timeout	Request execution timeout (how long to wait for a request to complete before shutting it down).

See also:

- Description of general Zabbix agent 2 configuration parameters: [Zabbix agent 2 \(UNIX\) / Zabbix agent 2 \(Windows\)](#)
- Instructions for configuring [plugins](#)

2 Docker plugin

Overview

This section lists parameters supported in the Docker Zabbix agent 2 plugin configuration file (docker.conf).

Note that:

- The default values reflect process defaults, not the values in the shipped configuration files;
- Values support [environment variables](#);
- Zabbix supports configuration files only in UTF-8 encoding without [BOM](#);
- Comments starting with `"#"` are only supported at the beginning of the line.

Parameters

Parameter	Mandatory	Range	Default	Description
Plugins.Docker.Endpoint			unix:///var/run/docker.sock	Docker socket location. Must contain a scheme (only <code>unix://</code> is supported).
Plugins.Docker.Timeout		1-30	global timeout	Request execution timeout (how long to wait for a request to complete before shutting it down).

See also:

- Description of general Zabbix agent 2 configuration parameters: [Zabbix agent 2 \(UNIX\) / Zabbix agent 2 \(Windows\)](#)
- Instructions for configuring [plugins](#)

3 Ember+ plugin

Overview

This section lists parameters supported in the Ember+ Zabbix agent 2 plugin configuration file (ember.conf).

The Ember+ plugin is a loadable plugin and is available and fully described in the [Ember+ plugin repository](#).

This plugin is currently only available to be built from the source (for both Unix and Windows).

Note that:

- The default values reflect process defaults, not the values in the shipped configuration files;
- Values support [environment variables](#);
- Zabbix supports configuration files only in UTF-8 encoding without [BOM](#);
- Comments starting with `"#"` are only supported at the beginning of the line.

Parameters

Parameter	Mandatory	Range	Default	Description
Plugins.EmberPlus.Default.Uri			tcp://localhost:9090	Default URI to connect. The only supported schema is <code>tcp://</code> . A schema can be omitted. Embedded credentials will be ignored.
Plugins.EmberPlus.KeepAlive		60-900	300	The maximum time of waiting (in seconds) before unused plugin connections are closed.

Parameter	Mandatory	Range	Default	Description
Plugins.EmberPlus.Sessions.<SessionName>.Urtcp://localhost:9999				Default URI to connect, for the named session. The only supported schema is tcp://. A schema can be omitted. Embedded credentials will be ignored. <SessionName> - define name of a session for using in item keys.
Plugins.EmberPlus.System.Path				Path to the Ember+ plugin executable. Example usage: Plugins.EmberPlus.System.Path=/usr/libexec/zabbix/zabbix
Plugins.EmberPlus.Timeout		1-30	global timeout	The amount of time to wait for a server to respond when first connecting and on follow-up operations in the session.

See also:

- Description of general Zabbix agent 2 configuration parameters: [Zabbix agent 2 \(UNIX\) / Zabbix agent 2 \(Windows\)](#)
- Instructions for configuring [plugins](#)

4 Memcached plugin

Overview

This section lists parameters supported in the Memcached Zabbix agent 2 plugin configuration file (memcached.conf).

Note that:

- The default values reflect process defaults, not the values in the shipped configuration files;
- Values support [environment variables](#);
- Zabbix supports configuration files only in UTF-8 encoding without [BOM](#);
- Comments starting with "#" are only supported at the beginning of the line.

Parameters

Parameter	Mandatory	Range	Default	Description
Plugins.Memcached.Default.Password				Default password for connecting to Memcached; used if no value is specified in an item key or named session.
Plugins.Memcached.Default.Uri			tcp://localhost:11211	Default URI for connecting to Memcached; used if no value is specified in an item key or named session. Should not include embedded credentials (they will be ignored). Must match the URI format. Supported schemes: tcp, unix; a scheme can be omitted. A port can be omitted (default=11211). Examples: tcp://localhost:11211 localhost unix:/var/run/memcached.sock
Plugins.Memcached.Default.User				Default username for connecting to Memcached; used if no value is specified in an item key or named session.
Plugins.Memcached.KeepAlive		60-900	300	The maximum time of waiting (in seconds) before unused plugin connections are closed.
Plugins.Memcached.Sessions.<SessionName>.Password				Named session password. <SessionName> - define name of a session for using in item keys.

Parameter	Mandatory	Range	Default	Description
Plugins.Memcached.Sessions.<SessionName>.Uri				Connection string of a named session. <SessionName> - define name of a session for using in item keys. Should not include embedded credentials (they will be ignored). Must match the URI format. Supported schemes: <code>tcp</code> , <code>unix</code> ; a scheme can be omitted. A port can be omitted (default=11211). Examples: <code>tcp://localhost:11211</code> <code>localhost</code> <code>unix:/var/run/memcached.sock</code>
Plugins.Memcached.Sessions.<SessionName>.User				Named session username. <SessionName> - define name of a session for using in item keys.
Plugins.Memcached.Timeout		1-30	global timeout	Request execution timeout (how long to wait for a request to complete before shutting it down).

See also:

- Description of general Zabbix agent 2 configuration parameters: [Zabbix agent 2 \(UNIX\) / Zabbix agent 2 \(Windows\)](#)
- Instructions for configuring [plugins](#)

5 Modbus plugin

Overview

This section lists parameters supported in the Modbus Zabbix agent 2 plugin configuration file (`modbus.conf`).

Note that:

- The default values reflect process defaults, not the values in the shipped configuration files;
- Values support [environment variables](#);
- Zabbix supports configuration files only in UTF-8 encoding without [BOM](#);
- Comments starting with `"#"` are only supported at the beginning of the line.

Parameters

Parameter	Mandatory	Range	Default	Description
Plugins.Modbus.Sessions.<SessionName>.Endpoint				Endpoint is a connection string consisting of a protocol scheme, a host address and a port or serial port name and attributes. <SessionName> - define name of a session for using in item keys.
Plugins.Modbus.Sessions.<SessionName>.SlaveID				Slave ID of a named session. <SessionName> - define name of a session for using in item keys. Example: <code>Plugins.Modbus.Sessions.MB1.SlaveID=20</code> <i>Note that this named session parameter is checked only if the value provided in the item key slave ID parameter is empty.</i>
Plugins.Modbus.Sessions.<SessionName>.Timeout				Timeout of a named session. <SessionName> - define name of a session for using in item keys. Example: <code>Plugins.Modbus.Sessions.MB1.Timeout=2</code>

If you need to set the request execution timeout (how long to wait for a request to complete before shutting it down), use the [item configuration](#) form.

See also:

- Description of general Zabbix agent 2 configuration parameters: [Zabbix agent 2 \(UNIX\) / Zabbix agent 2 \(Windows\)](#)
- Instructions for configuring [plugins](#)

6 MongoDB plugin

Overview

This section lists parameters supported in the MongoDB Zabbix agent 2 plugin configuration file (mongo.conf).

The MongoDB plugin is a loadable plugin and is available and fully described in the [MongoDB plugin repository](#).

Note that:

- The default values reflect process defaults, not the values in the shipped configuration files;
- Values support **environment variables**;
- Zabbix supports configuration files only in UTF-8 encoding without **BOM**;
- Comments starting with **"#"** are only supported at the beginning of the line.

Options

Parameter	Description
-V --version	Print the plugin version and license information.
-h --help	Print help information (shorthand).

Parameters

Parameter	Mandatory	Range	Default	Description
Plugins.MongoDB.Default.Password				Default password for connecting to MongoDB; used if no value is specified in an item key or named session.
Plugins.MongoDB.Default.Uri				Default URI for connecting to MongoDB; used if no value is specified in an item key or named session. Should not include embedded credentials (they will be ignored). Must match the URI format. Only tcp scheme is supported; a scheme can be omitted. A port can be omitted (default=27017). Examples: tcp://127.0.0.1:27017, tcp:localhost, localhost
Plugins.MongoDB.Default.User				Default username for connecting to MongoDB; used if no value is specified in an item key or named session.
Plugins.MongoDB.KeepAlive		60-900	300	The maximum time of waiting (in seconds) before unused plugin connections are closed.
Plugins.MongoDB.Sessions.<SessionName>.Password				Named session password. <SessionName> - define name of a session for using in item keys.
Plugins.MongoDB.Sessions.<SessionName>.TLSCAFile				Full pathname of a file containing the top-level CA(s) certificates for peer certificate verification, used for encrypted communications between Zabbix agent 2 and monitored databases. <SessionName> - define name of a session for using in item keys.
Plugins.MongoDB.Sessions.<SessionName>.TLSCertFile				Full pathname of a file containing the agent certificate or certificate chain, used for encrypted communications between Zabbix agent 2 and monitored databases. <SessionName> - define name of a session for using in item keys.

Parameter	Mandatory	Range	Default	Description
Plugins.MongoDB.Sessions.<SessionName>.TLSConnect				Encryption type for communications between Zabbix agent 2 and monitored databases. <SessionName> - define name of a session for using in item keys. Supported values: <i>required</i> - require TLS connection; <i>verify_ca</i> - verify certificates; <i>verify_full</i> - verify certificates and IP address.
Plugins.MongoDB.Sessions.<SessionName>.TLSKeyFile				Full pathname of a file containing the database private key used for encrypted communications between Zabbix agent 2 and monitored databases. <SessionName> - define name of a session for using in item keys.
Plugins.MongoDB.Sessions.<SessionName>.TLSCertificate	is specified			Full pathname of a file containing the database certificate used for encrypted communications between Zabbix agent 2 and monitored databases. <SessionName> - define name of a session for using in item keys.
Plugins.MongoDB.Sessions.<SessionName>.Uri				Connection string of a named session. <SessionName> - define name of a session for using in item keys. Should not include embedded credentials (they will be ignored). Must match the URI format. Only tcp scheme is supported; a scheme can be omitted. A port can be omitted (default=27017). Examples: tcp://127.0.0.1:27017, tcp:localhost, localhost
Plugins.MongoDB.Sessions.<SessionName>.User				Named session username. <SessionName> - define name of a session for using in item keys.
Plugins.MongoDB.System.Path				Path to the MongoDB plugin executable. Example usage: Plugins.MongoDB.System.Path=/usr/libexec/zabbix/zabbix-agent
Plugins.MongoDB.Timeout		1-30	global timeout	Request execution timeout (how long to wait for a request to complete before shutting it down).

See also:

- Description of general Zabbix agent 2 configuration parameters: [Zabbix agent 2 \(UNIX\) / Zabbix agent 2 \(Windows\)](#)
- Instructions for configuring [plugins](#)

7 MQTT plugin

Overview

This section lists parameters supported in the MQTT Zabbix agent 2 plugin configuration file (mqtt.conf).

Note that:

- The default values reflect process defaults, not the values in the shipped configuration files;
- Values support [environment variables](#);
- Zabbix supports configuration files only in UTF-8 encoding without [BOM](#);
- Comments starting with "#" are only supported at the beginning of the line.

Parameters

Parameter	Mandatory	Range	Default	Description
Plugins.MQTT.Default.Password				Default password for connecting to MQTT; used if no value is specified in an item key or named session.

Parameter	Mandatory	Range	Default	Description
Plugins.MQTT.Default.TLSCAFile				Full pathname of a file containing the top-level CA(s) certificates for peer certificate verification for encrypted communications between Zabbix agent 2 and MQTT broker; used if no value is specified in a named session.
Plugins.MQTT.Default.TLSCertFile				Full pathname of a file containing the agent certificate or certificate chain for encrypted communications between Zabbix agent 2 and MQTT broker; used if no value is specified in a named session.
Plugins.MQTT.Default.TLSKeyFile				Full pathname of a file containing the MQTT private key for encrypted communications between Zabbix agent 2 and MQTT broker; used if no value is specified in a named session.
Plugins.MQTT.Default.Topic				Default topic for MQTT subscription; used if no value is specified in an item key or named session. The topic may contain wildcards ("+", "#") Examples: path/to/file path/to/# path+/topic
Plugins.MQTT.Default.Url			tcp://localhost:1883	Default MQTT broker connection string; used if no value is specified in an item key or named session. Should not include query parameters. Must match the URL format. Supported schemes: tcp (default), ws, tls; a scheme can be omitted. A port can be omitted (default=1883). Examples: tcp://host:1883 localhost ws://host:8080
Plugins.MQTT.Default.User				Default username for connecting to MQTT; used if no value is specified in an item key or named session.
Plugins.MQTT.Sessions.<SessionName>.Password				Named session password. <SessionName> - define name of a session for using in item keys.
Plugins.MQTT.Sessions.<SessionName>.TLSCAFile				Full pathname of a file containing the top-level CA(s) certificates for peer certificate verification, used for encrypted communications between Zabbix agent 2 and MQTT broker. <SessionName> - define name of a session for using in item keys.
Plugins.MQTT.Sessions.<SessionName>.TLSCertFile				Full pathname of a file containing the agent certificate or certificate chain, used for encrypted communications between Zabbix agent 2 and MQTT broker. <SessionName> - define name of a session for using in item keys.
Plugins.MQTT.Sessions.<SessionName>.TLSKeyFile				Full pathname of a file containing the MQTT private key used for encrypted communications between Zabbix agent 2 and MQTT broker. <SessionName> - define name of a session for using in item keys.
Plugins.MQTT.Sessions.<SessionName>.Topic				Named session topic for MQTT subscription. <SessionName> - define name of a session for using in item keys. The topic may contain wildcards ("+", "#") Examples: path/to/file path/to/# path+/topic

Parameter	Mandatory	Range	Default	Description
Plugins.MQTT.Sessions.<SessionName>.Url				Connection string of a named session. <SessionName> - define name of a session for using in item keys. Should not include query parameters. Must match the URL format. Supported schemes: <code>tcp</code> (default), <code>ws</code> , <code>tls</code> ; a scheme can be omitted. A port can be omitted (default=1883). Examples: <code>tcp://host:1883</code> <code>localhost</code> <code>ws://host:8080</code>
Plugins.MQTT.Sessions.<SessionName>.User				Named session username. <SessionName> - define name of a session for using in item keys.

If you need to set the request execution timeout (how long to wait for a request to complete before shutting it down), use the [item configuration](#) form.

See also:

- Description of general Zabbix agent 2 configuration parameters: [Zabbix agent 2 \(UNIX\) / Zabbix agent 2 \(Windows\)](#)
- Instructions for configuring [plugins](#)

8 MSSQL plugin

Overview

This section lists parameters supported in the MSSQL Zabbix agent 2 plugin configuration file (`mssql.conf`).

The MSSQL plugin is a loadable plugin and is available and fully described in the [MSSQL plugin repository](#).

Note that:

- The default values reflect process defaults, not the values in the shipped configuration files;
- Values support [environment variables](#);
- Zabbix supports configuration files only in UTF-8 encoding without [BOM](#);
- Comments starting with `"#"` are only supported at the beginning of the line.

Parameters

Parameter	Mandatory	Range	Default	Description
Plugins.MSSQL.CustomQueriesDir			empty	Specifies the file path to a directory containing user-defined <code>.sql</code> files with custom queries that the plugin can execute. The plugin loads all available <code>.sql</code> files in the configured directory at startup. This means that any changes to the custom query files will not be reflected until the plugin is restarted. The plugin is started and stopped together with Zabbix agent 2.
Plugins.MSSQL.Default.CACertPath				The default file path to the public key certificate of the certificate authority (CA) that issued the certificate of the MSSQL server. The certificate must be in PEM format.
Plugins.MSSQL.Default.Database				The default database name to connect to.
Plugins.MSSQL.Default.Encrypt				Specifies the default connection encryption type. Possible values are: <i>true</i> - data sending between plugin and server is encrypted; <i>false</i> - data sending between plugin and server is not encrypted beyond the login packet; <i>strict</i> - data sending between plugin and server is encrypted E2E using TDS8 ; <i>disable</i> - data sending between plugin and server is not encrypted.
Plugins.MSSQL.Default.HostNameInCertificate				The common name (CN) of the certificate of the MSSQL server by default.

Parameter	Mandatory	Range	Default	Description
Plugins.MSSQL.Default.Password	Default			The password to be sent to a protected MSSQL server by default.
Plugins.MSSQL.Default.TLSMinVersion	Default			The minimum TLS version to use by default. Possible values are: 1.0, 1.1, 1.2, 1.3.
Plugins.MSSQL.Default.TrustServerCertificate	Default			Whether the plugin should trust the server certificate without validating it by default. Possible values: <code>true</code> , <code>false</code> .
Plugins.MSSQL.Default.Uri	Default		sqlserver://localhost	The default URI to connect. The only supported schema is <code>sqlserver://</code> . A schema can be omitted. Embedded credentials will be ignored.
Plugins.MSSQL.Default.User	Default			The default username to be sent to a protected MSSQL server.
Plugins.MSSQL.KeepAlive	Key	60-900	300	The maximum time of waiting (in seconds) before unused plugin connections are closed.
Plugins.MSSQL.Sessions.<SessionName>.CACertPath	Key			The file path to the public key certificate of the certificate authority (CA) that issued the certificate of the MSSQL server for the named session. The certificate must be in PEM format. <SessionName> - define name of a session for using in item keys.
Plugins.MSSQL.Sessions.<SessionName>.Database	Key			The database name to connect to for the named session. <SessionName> - define name of a session for using in item keys.
Plugins.MSSQL.Sessions.<SessionName>.Encrypt	Key			Specifies the connection encryption type for the named session. Possible values are: <i>true</i> - data sending between plugin and server is encrypted; <i>false</i> - data sending between plugin and server is not encrypted beyond the login packet; <i>strict</i> - data sending between plugin and server is encrypted E2E using TDS8 ; <i>disable</i> - data sending between plugin and server is not encrypted. <SessionName> - define name of a session for using in item keys.
Plugins.MSSQL.Sessions.<SessionName>.HostNameInCertificate	Key			The common name (CN) of the certificate of the MSSQL server for the named session. <SessionName> - define name of a session for using in item keys.
Plugins.MSSQL.Sessions.<SessionName>.Password	Key			The password to be sent to a protected MSSQL server for the named session. <SessionName> - define name of a session for using in item keys.
Plugins.MSSQL.Sessions.<SessionName>.TLSMinVersion	Key			The minimum TLS version to use for the named session. Possible values are: 1.0, 1.1, 1.2, 1.3. <SessionName> - define name of a session for using in item keys.
Plugins.MSSQL.Sessions.<SessionName>.TrustServerCertificate	Key			Whether the plugin should trust the server certificate without validating it for the named session. Possible values: <code>true</code> , <code>false</code> . <SessionName> - define name of a session for using in item keys.
Plugins.MSSQL.Sessions.<SessionName>.Uri	Key		sqlserver://localhost	The URI to connect, for the named session. The only supported schema is <code>sqlserver://</code> . A schema can be omitted. Embedded credentials will be ignored. <SessionName> - define name of a session for using in item keys.
Plugins.MSSQL.Sessions.<SessionName>.User	Key			The username to be sent to a protected MSSQL server for the named session. <SessionName> - define name of a session for using in item keys.
Plugins.MSSQL.System.Path	Key			Path to the MSSQL plugin executable. Global setting for the MSSQL plugin. Applied to all connections. Example usage: <code>Plugins.MSSQL.System.Path=/usr/libexec/zabbix/zabbix-agent</code>

Parameter	Mandatory	Range	Default	Description
Plugins.MSSQL.Timeout		1-30	global timeout	The amount of time to wait for a server to respond when first connecting and on follow-up operations in the session.

See also:

- Description of general Zabbix agent 2 configuration parameters: [Zabbix agent 2 \(UNIX\) / Zabbix agent 2 \(Windows\)](#)
- Instructions for configuring [plugins](#)

9 MySQL plugin

Overview

This section lists parameters supported in the MySQL Zabbix agent 2 plugin configuration file (mysql.conf).

Note that:

- The default values reflect process defaults, not the values in the shipped configuration files;
- Values support [environment variables](#);
- Zabbix supports configuration files only in UTF-8 encoding without [BOM](#);
- Comments starting with "#" are only supported at the beginning of the line.

Parameters

Parameter	Mandatory	Range	Default	Description
Plugins.MySQL.CallbackTimeout		1-30	global timeout	The maximum amount of time in seconds to wait for a request to be done.
Plugins.MySQL.CustomQueriesPath			empty	Full path to the directory used for storing custom queries.
Plugins.MySQL.Default.Password				Default password for connecting to MySQL; used if no value is specified in an item key or named session.
Plugins.MySQL.Default.TLSCAFile (yes, if Plugins.MySQL.Default.TLSConnect is set to <i>verify_ca</i> or <i>verify_full</i>)				Full pathname of a file containing the top-level CA(s) certificates for peer certificate verification for encrypted communications between Zabbix agent 2 and monitored databases; used if no value is specified in a named session.
Plugins.MySQL.Default.TLSCertFile (yes, if Plugins.MySQL.Default.TLSConnect is set to <i>verify_ca</i> or <i>verify_full</i>)				Full pathname of a file containing the agent certificate or certificate chain for encrypted communications between Zabbix agent 2 and monitored databases; used if no value is specified in a named session.
Plugins.MySQL.Default.TLSConnect				Encryption type for communications between Zabbix agent 2 and monitored databases; used if no value is specified in a named session. Supported values: <i>required</i> - require TLS connection; <i>verify_ca</i> - verify certificates; <i>verify_full</i> - verify certificates and IP address.
Plugins.MySQL.Default.TLSKeyFile (yes, if Plugins.MySQL.Default.TLSConnect is set to <i>verify_ca</i> or <i>verify_full</i>)				Full pathname of a file containing the database private key for encrypted communications between Zabbix agent 2 and monitored databases; used if no value is specified in a named session.

Parameter	Mandatory	Range	Default	Description
Plugins.Mysql.Default.Uri	Default		tcp://localhost:3306	Default URI for connecting to MySQL; used if no value is specified in an item key or named session. Should not include embedded credentials (they will be ignored). Must match the URI format. Supported schemes: <code>tcp</code> , <code>unix</code> ; a scheme can be omitted. A port can be omitted (default=3306). Examples: <code>tcp://localhost:3306</code> <code>localhost</code> <code>unix:/var/run/mysql.sock</code>
Plugins.Mysql.Default.User	Default			Default username for connecting to MySQL; used if no value is specified in an item key or named session.
Plugins.Mysql.KeepAlive		60-900	300	The maximum time of waiting (in seconds) before unused plugin connections are closed.
Plugins.Mysql.Sessions.<SessionName>.Password				Named session password. <SessionName> - define name of a session for using in item keys.
Plugins.Mysql.Sessions.<SessionName>.TLSCAFile (yes, if Plugins.Mysql.Sessions.<SessionName>.TLSConnect is set to <code>verify_ca</code> or <code>verify_full</code>)				Full pathname of a file containing the top-level CA(s) certificates for peer certificate verification, used for encrypted communications between Zabbix agent 2 and monitored databases. <SessionName> - define name of a session for using in item keys.
Plugins.Mysql.Sessions.<SessionName>.TLSCertFile (yes, if Plugins.Mysql.Sessions.<SessionName>.TLSConnect is specified)				Full pathname of a file containing the agent certificate or certificate chain, used for encrypted communications between Zabbix agent 2 and monitored databases. <SessionName> - define name of a session for using in item keys.
Plugins.Mysql.Sessions.<SessionName>.TLSConnect				Encryption type for communications between Zabbix agent 2 and monitored databases. <SessionName> - define name of a session for using in item keys. Supported values: <code>required</code> - require TLS connection; <code>verify_ca</code> - verify certificates; <code>verify_full</code> - verify certificates and IP address.
Plugins.Mysql.Sessions.<SessionName>.TLSKeyFile (yes, if Plugins.Mysql.Sessions.<SessionName>.TLSCertFile is specified)				Full pathname of a file containing the database private key used for encrypted communications between Zabbix agent 2 and monitored databases. <SessionName> - define name of a session for using in item keys.
Plugins.Mysql.Sessions.<SessionName>.Uri				Connection string of a named session. <SessionName> - define name of a session for using in item keys. Should not include embedded credentials (they will be ignored). Must match the URI format. Supported schemes: <code>tcp</code> , <code>unix</code> ; a scheme can be omitted. A port can be omitted (default=3306). Examples: <code>tcp://localhost:3306</code> <code>localhost</code> <code>unix:/var/run/mysql.sock</code>
Plugins.Mysql.Sessions.<SessionName>.User				Named session username. <SessionName> - define name of a session for using in item keys.
Plugins.Mysql.Timeout		1-30	global timeout	Request execution timeout (how long to wait for a request to complete before shutting it down).

See also:

- Description of general Zabbix agent 2 configuration parameters: [Zabbix agent 2 \(UNIX\) / Zabbix agent 2 \(Windows\)](#)
- Instructions for configuring [plugins](#)

10 NVIDIA GPU plugin

Overview

This section lists parameters supported in the NVIDIA GPU Zabbix agent 2 plugin configuration file (nvidia.conf).

The NVIDIA GPU plugin is a loadable plugin and is available and fully described in the [NVIDIA GPU plugin repository](#).

Note that:

- The default values reflect process defaults, not the values in the shipped configuration files;
- Values support [environment variables](#);
- Zabbix supports configuration files only in UTF-8 encoding without [BOM](#);
- Comments starting with “#” are only supported at the beginning of the line.

Parameters

Parameter	Mandatory	Range	Default	Description
Plugins.NVIDIA.System.Path				Path to the NVIDIA GPU plugin executable. Example usage: Plugins.NVIDIA.System.Path=/path/to/executable/nvidia
Plugins.NVIDIA.Timeout		1-30	global timeout	Specifies the maximum time (in seconds) to wait for a server response during connection attempts and subsequent operations in the session. The global item-type timeout or individual item timeout will override this value if greater.

See also:

- Description of general Zabbix agent 2 configuration parameters: [Zabbix agent 2 \(UNIX\) / Zabbix agent 2 \(Windows\)](#)
- Instructions for configuring [plugins](#)

11 Oracle plugin

Overview

This section lists parameters supported in the Oracle Zabbix agent 2 plugin configuration file (oracle.conf).

Note that:

- The default values reflect process defaults, not the values in the shipped configuration files;
- Values support [environment variables](#);
- Zabbix supports configuration files only in UTF-8 encoding without [BOM](#);
- Comments starting with “#” are only supported at the beginning of the line.

Parameters

Parameter	Mandatory	Range	Default	Description
Plugins.Oracle.CallTimeout		1-30	global timeout	The maximum wait time in seconds for a request to be completed.
Plugins.Oracle.ConnectTimeout		1-30	global timeout	The maximum wait time in seconds for a connection to be established.
Plugins.Oracle.CustomQueriesPath				Full pathname of a directory containing .sql files with custom queries. Disabled by default. Example: /etc/zabbix/oracle/sql
Plugins.Oracle.Default.Password				Default password for connecting to Oracle; used if no value is specified in an item key or named session.
Plugins.Oracle.Default.Service				Default service name for connecting to Oracle (SID is not supported); used if no value is specified in an item key or named session.

Parameter	Mandatory	Range	Default	Description
Plugins.Oracle.Default.Uri	Yes		tcp://localhost:1521	Default URI for connecting to Oracle; used if no value is specified in an item key or named session. Should not include embedded credentials (they will be ignored). Must match the URI format. Only tcp scheme is supported; a scheme can be omitted. A port can be omitted (default=1521). Examples: tcp://127.0.0.1:1521 localhost
Plugins.Oracle.Default.User	Yes			Default username for connecting to Oracle; used if no value is specified in an item key or named session.
Plugins.Oracle.KeepAlive	Yes	60-900	300	The maximum time of waiting (in seconds) before unused plugin connections are closed.
Plugins.Oracle.Sessions.<SessionName>.Password	Yes			Named session password. <SessionName> - define name of a session for using in item keys.
Plugins.Oracle.Sessions.<SessionName>.Service	Yes			Named session service name to be used for connection (SID is not supported). <SessionName> - define name of a session for using in item keys.
Plugins.Oracle.Sessions.<SessionName>.Uri	Yes			Named session connection string for Oracle. <SessionName> - define name of a session for using in item keys. Should not include embedded credentials (they will be ignored). Must match the URI format. Only tcp scheme is supported; a scheme can be omitted. A port can be omitted (default=1521). Examples: tcp://127.0.0.1:1521 localhost
Plugins.Oracle.Sessions.<SessionName>.User	Yes			Named session username. <SessionName> - define name of a session for using in item keys.

See also:

- Description of general Zabbix agent 2 configuration parameters: [Zabbix agent 2 \(UNIX\) / Zabbix agent 2 \(Windows\)](#)
- Instructions for configuring [plugins](#)

12 PostgreSQL plugin

Overview

This section lists parameters supported in the PostgreSQL Zabbix agent 2 plugin configuration file (postgresql.conf).

The PostgreSQL plugin is a loadable plugin and is available and fully described in the [PostgreSQL plugin repository](#).

Note that:

- The default values reflect process defaults, not the values in the shipped configuration files;
- Values support [environment variables](#);
- Zabbix supports configuration files only in UTF-8 encoding without [BOM](#);
- Comments starting with "#" are only supported at the beginning of the line.

Options

Parameter	Description
-V --version	Print the plugin version and license information.
-h --help	Print help information (shorthand).

Parameters

Parameter	Mandatory	Range	Default	Description
Plugins.PostgreSQL.Default.CacheMode			prepare	Cache mode for the PostgreSQL connection. Supported values: <i>prepare</i> (default) - will create prepared statements on the PostgreSQL server; <i>describe</i> - will use the anonymous prepared statement to describe a statement without creating a statement on the server. Note that "describe" is primarily useful when the environment does not allow prepared statements such as when running a connection pooler like PgBouncer.
Plugins.PostgreSQL.CallTimeout		1-30	global timeout	Maximum wait time (in seconds) for a request to be completed.
Plugins.PostgreSQL.CustomQueriesPath			disabled	Full pathname of the directory containing <i>.sql</i> files with custom queries.
Plugins.PostgreSQL.Default.Database				Default database for connecting to PostgreSQL; used if no value is specified in an item key or named session.
Plugins.PostgreSQL.Default.Password				Default password for connecting to PostgreSQL; used if no value is specified in an item key or named session.
Plugins.PostgreSQL.Default.TLSCAFile (yes, if Plugins.PostgreSQL.Default.TLSConnect is set to <i>verify_ca</i> or <i>verify_full</i>)				Full pathname of a file containing the top-level CA(s) certificate for peer certificate verification for encrypted communications between Zabbix agent 2 and monitored databases; used if no value is specified in a named session.
Plugins.PostgreSQL.Default.TLSCertFile (yes, if Plugins.PostgreSQL.Default.TLSConnect is set to <i>verify_ca</i> or <i>verify_full</i>)				Full pathname of a file containing the PostgreSQL certificate or certificate chain for encrypted communications between Zabbix agent 2 and monitored databases; used if no value is specified in a named session.
Plugins.PostgreSQL.Default.TLSConnect				Encryption type for communications between Zabbix agent 2 and monitored databases; used if no value is specified in a named session. Supported values: <i>required</i> - connect using TLS as transport mode without identity checks; <i>verify_ca</i> - connect using TLS and verify certificate; <i>verify_full</i> - connect using TLS, verify certificate and verify that database identity (CN) specified by DBHost matches its certificate. Undefined encryption type means unencrypted connection.
Plugins.PostgreSQL.Default.TLSKeyFile (yes, if Plugins.PostgreSQL.Default.TLSConnect is set to <i>verify_ca</i> or <i>verify_full</i>)				Full pathname of a file containing the PostgreSQL private key for encrypted communications between Zabbix agent 2 and monitored databases; used if no value is specified in a named session.
Plugins.PostgreSQL.Default.Uri				Default URI for connecting to PostgreSQL; used if no value is specified in an item key or named session. Should not include embedded credentials (they will be ignored). Must match the URI format. Supported schemes: <i>tcp</i> , <i>unix</i> . Examples: <i>tcp://127.0.0.1:5432</i> <i>tcp://localhost</i> <i>unix:/var/run/postgresql/.s.PGSQL.5432</i>
Plugins.PostgreSQL.Default.User				Default username for connecting to PostgreSQL; used if no value is specified in an item key or named session.

Parameter	Mandatory	Range	Default	Description
Plugins.PostgreSQL.KeepAlive	Yes	60-900	300	Maximum time of waiting (in seconds) before unused plugin connections are closed.
Plugins.PostgreSQL.Sessions.<SessionName>.CacheMode	Yes			Cache mode for the PostgreSQL connection. <SessionName> - define name of a session for using in item keys. Supported values: <i>prepare</i> (default) - will create prepared statements on the PostgreSQL server; <i>describe</i> - will use the anonymous prepared statement to describe a statement without creating a statement on the server. Note that "describe" is primarily useful when the environment does not allow prepared statements such as when running a connection pooler like PgBouncer.
Plugins.PostgreSQL.Sessions.<SessionName>.Database	Yes			Database for session connection. <SessionName> - define name of a session for using in item keys.
Plugins.PostgreSQL.Sessions.<SessionName>.Password	Yes	the password format.		Password for session connection. <SessionName> - define name of a session for using in item keys.
Plugins.PostgreSQL.Sessions.<SessionName>.TLSCAFile	Yes	(yes, if Plugins.PostgreSQL.Sessions.<SessionName>.TLSConnect is set to <i>verify_ca</i> or <i>verify_full</i>)		Full pathname of a file containing the top-level CA(s) certificate peer certificate verification. <SessionName> - define name of a session for using in item keys.
Plugins.PostgreSQL.Sessions.<SessionName>.TLSCertFile	Yes	(yes, if Plugins.PostgreSQL.Sessions.<SessionName>.TLSCertFile is specified)		Full pathname of a file containing the PostgreSQL certificate certificate chain. <SessionName> - define name of a session for using in item keys.
Plugins.PostgreSQL.Sessions.<SessionName>.TLSConnect	Yes			Encryption type for PostgreSQL connection. <SessionName> - define name of a session for using in item keys. Supported values: <i>required</i> - connect using TLS as transport mode without identity checks; <i>verify_ca</i> - connect using TLS and verify certificate; <i>verify_full</i> - connect using TLS, verify certificate and verify that database identity (CN) specified by DBHost matches its certificate. Undefined encryption type means unencrypted connection.
Plugins.PostgreSQL.Sessions.<SessionName>.TLSKeyFile	Yes	(yes, if Plugins.PostgreSQL.Sessions.<SessionName>.TLSConnect is specified)		Full pathname of a file containing the PostgreSQL private key. <SessionName> - define name of a session for using in item keys.
Plugins.PostgreSQL.Sessions.<SessionName>.Uri	Yes			Connection string of a named session. <SessionName> - define name of a session for using in item keys. Should not include embedded credentials (they will be ignored). Must match the URI format. Supported schemes: <i>tcp</i> , <i>unix</i> . Examples: <i>tcp://127.0.0.1:5432</i> <i>tcp://localhost</i> <i>unix:/var/run/postgresql/.s.PGSQL.5432</i>
Plugins.PostgreSQL.Sessions.<SessionName>.User	Yes			Named session username. <SessionName> - define name of a session for using in item keys.

Parameter	Mandatory	Range	Default	Description
Plugins.PostgreSQL.System.Path				Path to the PostgreSQL plugin executable. Example usage: Plugins.PostgreSQL.System.Path=/usr/libexec/zabbix/zabbix_
Plugins.PostgreSQL.Timeout		1-30	global timeout	Request execution timeout (how long to wait for a request to complete before shutting it down).

See also:

- Description of general Zabbix agent 2 configuration parameters: [Zabbix agent 2 \(UNIX\) / Zabbix agent 2 \(Windows\)](#)
- Instructions for configuring [plugins](#)

13 Redis plugin

Overview

This section lists parameters supported in the Redis Zabbix agent 2 plugin configuration file (redis.conf).

Note that:

- The default values reflect process defaults, not the values in the shipped configuration files;
- Values support [environment variables](#);
- Zabbix supports configuration files only in UTF-8 encoding without [BOM](#);
- Comments starting with "#" are only supported at the beginning of the line.

Parameters

Parameter	Mandatory	Range	Default	Description
Plugins.Redis.Default.Password				Default password for connecting to Redis; used if no value is specified in an item key or named session.
Plugins.Redis.Default.Uri			tcp://localhost:6379	Default URI for connecting to Redis; used if no value is specified in an item key or named session. Should not include embedded credentials (they will be ignored). Must match the URI format. Supported schemes: tcp, unix; a scheme can be omitted. A port can be omitted (default=6379). Examples: tcp://localhost:6379 localhost unix:/var/run/redis.sock
Plugins.Redis.KeepAlive		60-900	300	The maximum time of waiting (in seconds) before unused plugin connections are closed.
Plugins.Redis.Sessions.<SessionName>.Password				Named session password. <SessionName> - define name of a session for using in item keys.
Plugins.Redis.Sessions.<SessionName>.Uri				Connection string of a named session. <SessionName> - define name of a session for using in item keys.
Plugins.Redis.Timeout		1-30	global timeout	Request execution timeout (how long to wait for a request to complete before shutting it down).

See also:

- Description of general Zabbix agent 2 configuration parameters: [Zabbix agent 2 \(UNIX\) / Zabbix agent 2 \(Windows\)](#)
- Instructions for configuring [plugins](#)

14 Smart plugin

Overview

This section lists parameters supported in the Smart Zabbix agent 2 plugin configuration file (smart.conf).

Note that:

- The default values reflect process defaults, not the values in the shipped configuration files;
- Values support [environment variables](#);
- Zabbix supports configuration files only in UTF-8 encoding without [BOM](#);
- Comments starting with “#” are only supported at the beginning of the line.

Parameters

Parameter	Mandatory	Range	Default	Description
Plugins.Smart.Path			smartctl	Path to the smartctl executable.
Plugins.Smart.Timeout		1-30	global timeout	Request execution timeout (how long to wait for a request to complete before shutting it down).

See also:

- Description of general Zabbix agent 2 configuration parameters: [Zabbix agent 2 \(UNIX\) / Zabbix agent 2 \(Windows\)](#)
- Instructions for configuring [plugins](#)

8 Zabbix Java gateway

If you use `startup.sh` and `shutdown.sh` scripts for starting [Zabbix Java gateway](#), then you can specify the necessary configuration parameters in the `settings.sh` file. The startup and shutdown scripts source the settings file and take care of converting shell variables (listed in the first column) to Java properties (listed in the second column).

If you start Zabbix Java gateway manually by running `java` directly, then you specify the corresponding Java properties on the command line.

Variable	Property	Mandatory	Range	Default	Description
LISTEN_IP	zabbix.listenIP	no		0.0.0.0	IP address to listen on.
LISTEN_PORT	zabbix.listenPort	no	1024-32767	10052	Port to listen on.
PID_FILE	zabbix.pidFile	no		/tmp/zabbix_java.pid	Name of PID file. If omitted, Zabbix Java Gateway is started as a console application.
PROPERTIES_FILE	zabbix.propertiesFile	no			Name of properties file. Can be used to set additional properties using a key-value format in such a way that they are not visible on a command line or to overwrite existing ones. For example: "javax.net.ssl.trustStorePassword=<p>
START_POLLERS	zabbix.startPollers	no	1-1000	5	Number of worker threads to start.
TIMEOUT	zabbix.timeout	no	1-30	3	How long to wait for network operations.

Warning:

Port 10052 is not [IANA registered](#).

9 Zabbix web service

Overview

The Zabbix web service is a process that is used for communication with external web services.

The parameters supported by the Zabbix web service configuration file (zabbix_web_service.conf) are listed in this section.

The parameters are listed without additional information. Click on the parameter to see the full details.

Parameter	Description
AllowedIP	A list of comma delimited IP addresses, optionally in CIDR notation, or DNS names of Zabbix servers and Zabbix proxies.
DebugLevel	The debug level.
ListenPort	The agent will listen on this port for connections from the server.
LogFile	The name of the log file.
LogFileSize	The maximum size of the log file.
LogType	The type of the log output.
Timeout	The maximum time (in seconds) spent formatting the PDF report of a dashboard.
TLSAccept	What incoming connections to accept.
TLSCAFile	The full pathname of a file containing the top-level CA(s) certificates for peer certificate verification, used for encrypted communications between Zabbix components.
TLSCertFile	The full pathname of a file containing the service certificate or certificate chain, used for encrypted communications between Zabbix components.
TLSKeyFile	The full pathname of a file containing the service private key, used for encrypted communications between Zabbix components.

All parameters are non-mandatory unless explicitly stated that the parameter is mandatory.

Note that:

- The default values reflect process defaults, not the values in the shipped configuration files;
- Values support **environment variables**;
- Zabbix supports configuration files only in UTF-8 encoding without **BOM**;
- Comments starting with **"#"** are only supported at the beginning of the line.

Parameter details

AllowedIP

A list of comma delimited IP addresses, optionally in CIDR notation, or DNS names of Zabbix servers and Zabbix proxies. Incoming connections will be accepted only from the hosts listed here.
If IPv6 support is enabled then 127.0.0.1, ::127.0.0.1, ::ffff:127.0.0.1 are treated equally and ::/0 will allow any IPv4 or IPv6 address. 0.0.0.0/0 can be used to allow any IPv4 address.

Example:

```
127.0.0.1,192.168.1.0/24,::1,2001:db8::/32,zabbix.example.com
```

Mandatory: yes

DebugLevel

Specify the debug level:
0 - basic information about starting and stopping of Zabbix processes
1 - critical information;
2 - error information;
3 - warnings;
4 - for debugging (produces lots of information);
5 - extended debugging (produces even more information).

Default: 3
 Range: 0-5

ListenPort

The service will listen on this port for connections from the server.

Default: 10053
 Range: 1024-32767

LogFile

The name of the log file.

Example:

```
/tmp/zabbix_web_service.log
```

Mandatory: Yes, if LogType is set to *file*; otherwise no

LogFileSize

The maximum size of a log file in MB.
0 - disable automatic log rotation.
Note: If the log file size limit is reached and file rotation fails, for whatever reason, the existing log file is truncated and started anew.

Default: 1
 Range: 0-1024

LogType

The type of the log output:
file - write log to the file specified by LogFile parameter;
system - write log to syslog;
console - write log to standard output.

Default: *file*

Timeout

The maximum time (in seconds) spent formatting the PDF *report* of a dashboard.

Default: 10
 Range: 1-30

TLSAccept

What incoming connections to accept:
unencrypted - accept connections without encryption (default)
cert - accept connections with TLS and a certificate

Default: *unencrypted*

TLSCAFile

The full pathname of the file containing the top-level CA(s) certificates for peer certificate verification, used for encrypted communications between Zabbix components.

TLSCertFile

The full pathname of the file containing the service certificate or certificate chain, used for encrypted communications with Zabbix components.

TLSKeyFile

The full pathname of the file containing the service private key, used for encrypted communications between Zabbix components.

10 Environment variables

Overview

Environment variables allow configuring Zabbix components without hardcoding values in configuration files. This makes it easy to manage configurations in dynamic environments, such as Docker, where variables can be passed at runtime to adapt to different setups.

In the simplest case, by setting the Zabbix server *DebugLevel* configuration parameter value to an environment variable, you can then use it to configure the server on startup:

```
#### Zabbix server configuration file:
DebugLevel=${NewDebugLevel}

#### Starting Zabbix server:
NewDebugLevel=5 /usr/sbin/zabbix_server
```

Environment variables are supported by the following Zabbix components:

- *Server*
- *Proxy*
- *Agent (UNIX or Windows)*
- *Agent 2 (UNIX or Windows)*, including *plugins*
- *Web service*
- Zabbix sender (when using the *-c, --config* option)

Important notes

- When a configuration parameter is set to an environment variable, which is not specified when running the component, the default value of the parameter is used.

- When using **runtime commands** (e.g., to increase the agent log level), any previously used environment variables must be specified. This is because Zabbix components use their configuration file to execute runtime commands; if environment variables are omitted, configuration parameter default values will be used. See **Examples**.
- The `userparameter_reload` **runtime command** does not support reloading environment variables. During reload, variables are ignored, and only parameters with regular values are reloaded.
- Process current environment variables, which were used in configuration files, are cleared after the Zabbix component is started. This ensures that child processes (e.g., remote scripts executed by Zabbix) cannot access these variables. However, note that process initial variables can still be retrieved (e.g., via the `/proc/<PID>/environ` file).

Syntax

Environment variables must use the following syntax: `${alphanumerics/underscores}`.

The variable name may only include letters (a-z, A-Z), underscores (`_`), and digits (0-9), and must not begin with a digit.

Variables that do not match the required syntax or are combined with a regular value will be treated as regular values, which may produce errors.

Correct variable syntax:

```
DebugLevel=${NewDebugLevel}
Hostname=${ZBX_HOSTNAME}
LogFile=${LogFile_001}
```

Incorrect variable syntax:

```
DebugLevel=${5_DebugLevel}
Hostname=${ZBX.HOSTNAME 1}
LogFile=${HOME}/zabbix/zabbix_server.log
```

Note:

In Windows, environment variable names are case-insensitive.

Examples

The following examples show how to configure and use environment variables with Zabbix components.

Example 1: Configuring and testing Zabbix agent

1. Set environment variables in the agent configuration file:

```
Hostname=${ZBX_HOSTNAME}
ServerActive=${ServerActive}
```

2. Test the configuration file:

```
ZBX_HOSTNAME="New Zabbix agent" ServerActive=127.0.0.1 /usr/sbin/zabbix_agentd -c /etc/zabbix/zabbix_agentd.conf
```

3. Start agent with environment variables:

```
ZBX_HOSTNAME="New Zabbix agent" ServerActive=127.0.0.1 /usr/sbin/zabbix_agentd -c /etc/zabbix/zabbix_agentd.conf
```

When using **runtime commands** (e.g., to increase the agent log level), any previously used environment variables must be specified:

```
ZBX_HOSTNAME="New Zabbix agent" ServerActive=127.0.0.1 /usr/sbin/zabbix_agentd -c /etc/zabbix/zabbix_agentd.conf
```

This is because agent uses its configuration file to execute runtime commands; if environment variables are omitted, configuration parameter default values will be used.

Alternatively, after setting environment variables in the agent configuration file, you may make them available to processes (e.g., by using the `export` command). This reduces the risk of unexpected behavior due to missing or incorrectly set variables.

```
export ZBX_HOSTNAME="New Zabbix agent"
export ServerActive=127.0.0.1
/usr/sbin/zabbix_agentd -c /etc/zabbix/zabbix_agentd.conf --test-config
/usr/sbin/zabbix_agentd -c /etc/zabbix/zabbix_agentd.conf
/usr/sbin/zabbix_agentd -c /etc/zabbix/zabbix_agentd.conf -R log_level_increase
```

Example 2: Configuring Zabbix agent for a container

If you're creating and configuring your own custom image for Zabbix components (e.g., Zabbix agent), you can define configuration parameters using environment variables and then start the container with those variables.

1. When preparing the image, set environment variables in the agent configuration file:

```
Hostname=${ZBX_HOSTNAME}
BufferSize=${BUFSZ}
ListenPort=${LISTENPORT}
UserParameter=${_UsrPar01}
UserParameter=${_UsrPar02}
```

2. After building the container image, start the agent container (e.g., Docker) with environment variables:

```
docker run --name my-zabbix-agent -e ZBX_HOSTNAME="new-hostname" -e BUFSZ=1000 -e LISTENPORT=20050 -e _Usr
```

3. When using **runtime commands** (e.g., to increase the agent log level), access the container shell and execute the runtime command:

```
docker exec -it <containerid> sh
/usr/sbin/zabbix_agentd -R log_level_increase
```

Attention:

The `userparameter_reload` runtime command does not support reloading environment variables. During reload, variables are ignored, and only parameters with regular values are reloaded.

11 Inclusion

Overview

Additional files or directories can be included into server/proxy/agent configuration using the `Include` parameter.

Notes on inclusion

If the `Include` parameter is used for including a file, the file must be readable.

If the `Include` parameter is used for including a directory:

- All files in the directory must be readable.
- No particular order of inclusion should be assumed (e.g. files are not included in alphabetical order). Therefore do not define one parameter in several "Include" files (e.g. to override a general setting with a specific one).
- All files in the directory are included into configuration.
- Beware of file backup copies automatically created by some text editors. For example, if editing the "include/my_specific.conf" file produces a backup copy "include/my_specific_conf.BAK" then both files will be included. Move "include/my_specific.conf.BAK" out of the "Include" directory. On Linux, contents of the "Include" directory can be checked with a "ls -al" command for unnecessary files.

If the `Include` parameter is used for including files using a pattern:

- All files matching the pattern must be readable.
- No particular order of inclusion should be assumed (e.g. files are not included in alphabetical order). Therefore do not define one parameter in several "Include" files (e.g. to override a general setting with a specific one).

3 Protocols

Please use the sidebar to access content in this section.

1 Server-proxy data exchange protocol

Overview

Server - proxy data exchange is based on JSON format.

Request and response messages must begin with **header and data length**.

Passive proxy

Configuration request

The server will first send an empty `proxy config` request. This request is sent every `ProxyConfigFrequency` (server configuration parameter) seconds.

The proxy responds with the current proxy version, session token and configuration revision. The server responds with the configuration data that need to be updated.

name	value type	description
server→proxy: request	<i>string</i>	'proxy config'
proxy→server: version	<i>string</i>	Proxy version (<major>.<minor>.<build>).
session	<i>string</i>	Proxy configuration session token.
config_revision	<i>number</i>	Proxy configuration revision.
server→proxy: full_sync	<i>number</i>	1 - if full configuration data is sent; absent - otherwise (optional).
data	<i>array</i>	Object of table data. Absent if configuration has not been changed (optional).
<table>	<i>object</i>	One or more objects with <table> data (optional, depending on changes).
fields	<i>array</i>	Array of field names.
-	<i>string</i>	Field name.
data	<i>array</i>	Array of rows.
-	<i>array</i>	Array of columns.
-	<i>string,number</i>	Column value with type depending on column type in database schema.
macro.secrets	<i>object</i>	Secret macro information, absent if there are no changes in vault macros (optional).
config_revision	<i>number</i>	Configuration cache revision - sent with configuration data (optional).
del_hostids	<i>array</i>	Array of removed hostids (optional).
-	<i>number</i>	Host identifier.
del_macro_hostids	<i>array</i>	Array of hostids with all macros removed (optional).
-	<i>number</i>	Host identifier.
proxy→server: response	<i>string</i>	Request success information ('success' or 'failed').
version	<i>string</i>	Proxy version (<major>.<minor>.<build>).

Example:

server→proxy:

server→proxy:

```
{
  "request":"proxy config"
}
```

proxy→server:

```
{
  "version": "7.4.0",
  "session": "0033124949800811e5686dbfd9bcea98",
  "config_revision": 0
}
```

server→proxy:

```
{
  "full_sync": 1,
  "data": {
    "hosts": {
      "fields": ["hostid", "host", "status", "ipmi_authtype", "ipmi_privilege", "ipmi_username", "ipmi_password"],
      "data": [
        [10084, "Zabbix server", 0, -1, 2, "", "", "Zabbix server", 1, 1, "", "", "", ""]
      ]
    }
  }
}
```

```

]
},
"interface": {
"fields": ["interfaceid", "hostid", "main", "type", "useip", "ip", "dns", "port", "available"],
"data": [
[1, 10084, 1, 1, 1, "127.0.0.1", "", "10053", 1]
]
},
"interface_snmp": {
"fields": ["interfaceid", "version", "bulk", "community", "securityname", "securitylevel", "authpassphrase"],
"data": []
},
"host_inventory": {
"fields": ["hostid", "type", "type_full", "name", "alias", "os", "os_full", "os_short", "serialno_a", "ser"],
"data": [
[10084, "", "", "", "", "", "", "", "", "", "", "", "", "", "", "", "", "", "", "", "", "", "", "", "", "", "5"]
]
},
"items": {
"fields": ["itemid", "type", "snmp_oid", "hostid", "key_", "delay", "history", "status", "value_type", "tr"],
"data": [
[44161, 7, "", 10084, "agent.hostmetadata", "10s", "90d", 0, 1, "", "", "", "", 0, "", "", "", "", 0, null],
[44162, 0, "", 10084, "agent.ping", "10s", "90d", 0, 3, "", "", "", "", 0, "", "", "", "", 0, 1, 0, "", nu]
]
},
"item_rtdata": {
"fields": ["itemid", "lastlogsize", "mtime"],
"data": [
[44161, 0, 0],
[44162, 0, 0]
]
},
"item_preproc": {
"fields": ["item_preprocid", "itemid", "step", "type", "params", "error_handler", "error_handler_params"],
"data": []
},
"item_parameter": {
"fields": ["item_parameterid", "itemid", "name", "value"],
"data": []
},
"globalmacro": {
"fields": ["globalmacroid", "macro", "value", "type"],
"data": [
[2, "{$SNMP_COMMUNITY}", "public", 0]
]
},
"hosts_templates": {
"fields": ["hosttemplateid", "hostid", "templateid", "link_type"],
"data": []
},
"hostmacro": {
"fields": ["hostmacroid", "hostid", "macro", "value", "type", "automatic"],
"data": [
[5676, 10084, "{$M}", "AppID=zabbix_server&Query=Safe=passwordSafe;Object=zabbix:Content", 2, 0]
]
},
"drules": {
"fields": ["druleid", "name", "iprange", "delay"],
"data": [
[2, "Local network", "127.0.0.1", "10s"]
]
},
}

```



```

"fields": ["autoreg_tlsid", "tls_psk_identity", "tls_psk"],
"data": [
[1, "", ""]
]
},
},
"macro.secrets": {
"AppID=zabbix_server&Query=Safe=passwordSafe;Object=zabbix": {
"Content": "738"
}
},
"config_revision": 2
}

```

proxy→server:

```

{
"response": "success",
"version": "7.4.0"
}

```

Data request

The proxy data request is used to obtain host interface availability, historical, discovery and autoregistration data from proxy. This request is sent every ProxyDataFrequency (server configuration parameter) seconds.

name	value type	description
server→proxy: request	<i>string</i>	'proxy data'
proxy→server: session	<i>string</i>	Data session token.
interface	<i>array</i>	(<i>optional</i>) Array of interface availability data objects.
avail- abil- ity		
interfaceid	<i>number</i>	Interface identifier.
available	<i>number</i>	Interface availability: 0 , <i>INTERFACE_AVAILABLE_UNKNOWN</i> - unknown 1 , <i>INTERFACE_AVAILABLE_TRUE</i> - available 2 , <i>INTERFACE_AVAILABLE_FALSE</i> - unavailable
error	<i>string</i>	Interface error message or empty string.
history	<i>array</i>	(<i>optional</i>) Array of history data objects.
data		
itemid	<i>number</i>	Item identifier.
clock	<i>number</i>	Item value timestamp (seconds).
ns	<i>number</i>	Item value timestamp (nanoseconds).
value	<i>string</i>	(<i>optional</i>) Item value.
id	<i>number</i>	Value identifier (ascending counter, unique within one data session).
timestamp	<i>number</i>	(<i>optional</i>) Timestamp of log type items.
source	<i>string</i>	(<i>optional</i>) Eventlog item source value.
severity	<i>number</i>	(<i>optional</i>) Eventlog item severity value.
eventid	<i>number</i>	(<i>optional</i>) Eventlog item eventid value.
state	<i>string</i>	(<i>optional</i>) Item state: 0 , <i>ITEM_STATE_NORMAL</i> 1 , <i>ITEM_STATE_NOTSUPPORTED</i>
lastlogsize	<i>number</i>	(<i>optional</i>) Last log size of log type items.
mtime	<i>number</i>	(<i>optional</i>) Modification time of log type items.
discovery	<i>array</i>	(<i>optional</i>) Array of discovery data objects.
data		
clock	<i>number</i>	Discovery data timestamp.
druleid	<i>number</i>	Discovery rule identifier.
dcheckid	<i>number</i>	Discovery check identifier or null for discovery rule data.

name	value type	description
type	<i>number</i>	Discovery check type: -1 discovery rule data 0 , <i>SVC_SSH</i> - SSH service check 1 , <i>SVC_LDAP</i> - LDAP service check 2 , <i>SVC_SMTP</i> - SMTP service check 3 , <i>SVC_FTP</i> - FTP service check 4 , <i>SVC_HTTP</i> - HTTP service check 5 , <i>SVC_POP</i> - POP service check 6 , <i>SVC_NNTP</i> - NNTP service check 7 , <i>SVC_IMAP</i> - IMAP service check 8 , <i>SVC_TCP</i> - TCP port availability check 9 , <i>SVC_AGENT</i> - Zabbix agent 10 , <i>SVC_SNMPv1</i> - SNMPv1 agent 11 , <i>SVC_SNMPv2</i> - SNMPv2 agent 12 , <i>SVC_ICMPPING</i> - ICMP ping 13 , <i>SVC_SNMPv3</i> - SNMPv3 agent 14 , <i>SVC_HTTPS</i> - HTTPS service check 15 , <i>SVC_TELNET</i> - Telnet availability check
ip	<i>string</i>	Host IP address.
dns	<i>string</i>	Host DNS name.
port	<i>number</i>	<i>(optional)</i> Service port number.
key_value	<i>string</i>	<i>(optional)</i> Item key for discovery check of type 9 <i>SVC_AGENT</i>
value	<i>string</i>	<i>(optional)</i> Value received from the service, can be empty for most of services.
status	<i>number</i>	<i>(optional)</i> Service status: 0 , <i>DOBJECT_STATUS_UP</i> - Service UP 1 , <i>DOBJECT_STATUS_DOWN</i> - Service DOWN
auto registration	<i>array</i>	<i>(optional)</i> Array of autoregistration data objects.
clock	<i>number</i>	Autoregistration data timestamp.
host	<i>string</i>	Host name.
ip	<i>string</i>	<i>(optional)</i> Host IP address.
dns	<i>string</i>	<i>(optional)</i> Resolved DNS name from IP address.
port	<i>string</i>	<i>(optional)</i> Host port.
host_metadata	<i>string</i>	<i>(optional)</i> Host metadata sent by agent (based on HostMetadata or HostMetadataItem agent configuration parameter).
tasks	<i>array</i>	<i>(optional)</i> Array of tasks.
type	<i>number</i>	Task type: 0 , <i>ZBX_TM_TASK_PROCESS_REMOTE_COMMAND_RESULT</i> - remote command result
status	<i>number</i>	Remote-command execution status: 0 , <i>ZBX_TM_REMOTE_COMMAND_COMPLETED</i> - remote command completed successfully 1 , <i>ZBX_TM_REMOTE_COMMAND_FAILED</i> - remote command failed
error	<i>string</i>	<i>(optional)</i> Error message.
parent_taskid	<i>number</i>	Parent task ID.
more	<i>number</i>	<i>(optional)</i> 1 - there are more history data to send.
clock	<i>number</i>	<i>(optional)</i> Data transfer timestamp (seconds).
ns	<i>number</i>	<i>(optional)</i> Data transfer timestamp (nanoseconds).
version	<i>string</i>	Proxy version (<major>.<minor>.<build>).
server→proxy:		
response	<i>string</i>	Request success information ('success' or 'failed').
tasks	<i>array</i>	<i>(optional)</i> Array of tasks.

name	value type	description
type	<i>number</i>	Task type: 1 , ZBX_TM_TASK_PROCESS_REMOTE_COMMAND - remote command
clock	<i>number</i>	Task creation time.
ttd	<i>number</i>	Time in seconds after which the task expires.
commandtype	<i>number</i>	Remote-command type: 0 , ZBX_SCRIPT_TYPE_CUSTOM_SCRIPT - use custom script 1 , ZBX_SCRIPT_TYPE_IPMI - use IPMI 2 , ZBX_SCRIPT_TYPE_SSH - use SSH 3 , ZBX_SCRIPT_TYPE_TELNET - use Telnet 4 , ZBX_SCRIPT_TYPE_GLOBAL_SCRIPT - use global script (currently functionally equivalent to custom script)
command	<i>string</i>	Remote command to execute.
execute_on	<i>number</i>	Execution target for custom scripts: 0 , ZBX_SCRIPT_EXECUTE_ON_AGENT - execute script on agent 1 , ZBX_SCRIPT_EXECUTE_ON_SERVER - execute script on server 2 , ZBX_SCRIPT_EXECUTE_ON_PROXY - execute script on proxy
port	<i>number</i>	(optional) Port for Telnet and SSH commands.
authtype	<i>number</i>	(optional) Authentication type for SSH commands.
username	<i>string</i>	(optional) User name for Telnet and SSH commands.
password	<i>string</i>	(optional) Password for Telnet and SSH commands.
publickey	<i>string</i>	(optional) Public key for SSH commands.
privatekey	<i>string</i>	(optional) Private key for SSH commands.
parent_taskid	<i>number</i>	Parent task ID.
hostid	<i>number</i>	Target host ID.

Example:

server→proxy:

```
{
  "request": "proxy data"
}
```

proxy→server:

```
{
  "session": "12345678901234567890123456789012"
  "interface availability": [
    {
      "interfaceid": 1,
      "available": 1,
      "error": ""
    },
    {
      "interfaceid": 2,
      "available": 2,
      "error": "Get value from agent failed: cannot connect to [[127.0.0.1]:10049]: [111] Connection
    },
    {
      "interfaceid": 3,
      "available": 1,
      "error": ""
    },
    {
      "interfaceid": 4,
      "available": 1,
      "error": ""
    }
  ]
}
```

```

"history data":[
  {
    "itemid":"12345",
    "clock":1478609647,
    "ns":332510044,
    "value":"52956612",
    "id": 1
  },
  {
    "itemid":"12346",
    "clock":1478609647,
    "ns":330690279,
    "state":1,
    "value":"Cannot find information for this network interface in /proc/net/dev.",
    "id": 2
  }
],
"discovery data":[
  {
    "clock":1478608764,
    "drule":2,
    "dcheck":3,
    "type":12,
    "ip":"10.3.0.10",
    "dns":"vdebian",
    "status":1
  },
  {
    "clock":1478608764,
    "drule":2,
    "dcheck":null,
    "type":-1,
    "ip":"10.3.0.10",
    "dns":"vdebian",
    "status":1
  }
],
"auto registration":[
  {
    "clock":1478608371,
    "host":"Logger1",
    "ip":"10.3.0.1",
    "dns":"localhost",
    "port":"10050"
  },
  {
    "clock":1478608381,
    "host":"Logger2",
    "ip":"10.3.0.2",
    "dns":"localhost",
    "port":"10050"
  }
],
"tasks":[
  {
    "type": 0,
    "status": 0,
    "parent_taskid": 10
  },
  {
    "type": 0,
    "status": 1,

```

```

        "error": "No permissions to execute task.",
        "parent_taskid": 20
    }
],
"version": "7.4.0"
}

```

server→proxy:

```

{
  "response": "success",
  "tasks": [
    {
      "type": 1,
      "clock": 1478608371,
      "ttl": 600,
      "commandtype": 2,
      "command": "restart_service1.sh",
      "execute_on": 2,
      "port": 80,
      "authtype": 0,
      "username": "userA",
      "password": "password1",
      "publickey": "MIGfMAOGCSqGSIb3DQEBAQUAA4GNADCBiQKBgQCqGKuk01De7zhZj6+H0qtjTkVxwTCpvKe",
      "privatekey": "lsuusFncCzWBQ7RKNUSesmQRMSGkVb1/3j+skZ6UtW+5u09lHNsj6tQ5QcGKuk01De7zhd",
      "parent_taskid": 10,
      "hostid": 10070
    },
    {
      "type": 1,
      "clock": 1478608381,
      "ttl": 600,
      "commandtype": 1,
      "command": "restart_service2.sh",
      "execute_on": 0,
      "authtype": 0,
      "username": "",
      "password": "",
      "publickey": "",
      "privatekey": "",
      "parent_taskid": 20,
      "hostid": 10084
    }
  ]
}

```

Active proxy

Configuration request

The proxy config request is sent by active proxy to obtain proxy configuration data. This request is sent every ProxyConfigFrequency (proxy configuration parameter) seconds.

name	value type	description
proxy→server:		
request	<i>string</i>	'proxy config'
host	<i>string
</i>	Proxy name.
version	<i>string</i>	Proxy version (<major>.<minor>.<build>).
session	<i>string</i>	Proxy configuration session token.
config_revision	<i>number</i>	Proxy configuration revision.
server→proxy:		
fullsync	<i>number</i>	1 - if full configuration data is sent, absent otherwise (optional).

name	value type	description
data	<i>array</i>	Object of table data. Absent if configuration has not been changed (optional).
<table>	<i>object</i>	One or more objects with <table> data (optional, depending on changes).
fields	<i>array</i>	Array of field names.
-	<i>string</i>	Field name.
data	<i>array</i>	Array of rows.
-	<i>array</i>	Array of columns.
-	<i>string,number</i>	Column value with type depending on column type in database schema.
macro.secrets	<i>object</i>	Secret macro information, absent if there are no changes in vault macros (optional).
config_revision	<i>number</i>	Configuration cache revision - sent with configuration data (optional).
del_hostids	<i>array</i>	Array of removed hostids (optional).
-	<i>number</i>	Host identifier.
del_macro_hostids	<i>array</i>	Array of hostids with all macros removed (optional).
-	<i>number</i>	Host identifier.

Example:

proxy→server:

```
{
  "request": "proxy config",
  "host": "Zabbix proxy",
  "version": "7.4.0",
  "session": "fd59a09ff4e9d1fb447de1f04599bcf6",
  "config_revision": 0
}
```

server→proxy:

```
{
  "full_sync": 1,
  "data": {
    "hosts": {
      "fields": ["hostid", "host", "status", "ipmi_authtype", "ipmi_privilege", "ipmi_username", "ipmi_password"],
      "data": [
        [10084, "Zabbix server", 0, -1, 2, "", "", "Zabbix server", 1, 1, "", "", "", ""]
      ]
    },
    "interface": {
      "fields": ["interfaceid", "hostid", "main", "type", "useip", "ip", "dns", "port", "available"],
      "data": [
        [1, 10084, 1, 1, 1, "127.0.0.1", "", "10053", 1]
      ]
    },
    "interface_snmp": {
      "fields": ["interfaceid", "version", "bulk", "community", "securityname", "securitylevel", "authpassphrase"],
      "data": []
    },
    "host_inventory": {
      "fields": ["hostid", "type", "type_full", "name", "alias", "os", "os_full", "os_short", "serialno_a", "ser"],
      "data": [
        [10084, "", "", "", "", "", "", "", "", "", "", "", "", "", "", "", "", "", "", "", "", "", "", "", "5"]
      ]
    },
    "items": {
      "fields": ["itemid", "type", "snmp_oid", "hostid", "key_", "delay", "history", "status", "value_type", "tr"],
      "data": [

```

```

[44161, 7, "", 10084, "agent.hostmetadata", "10s", "90d", 0, 1, "", "", "", "", 0, "", "", "", "", 0, null
[44162, 0, "", 10084, "agent.ping", "10s", "90d", 0, 3, "", "", "", "", 0, "", "", "", "", 0, 1, 0, "", nu
]
},
"item_rtdata": {
"fields": ["itemid", "lastlogsize", "mtime"],
"data": [
[44161, 0, 0],
[44162, 0, 0]
]
},
"item_preproc": {
"fields": ["item_preprocid", "itemid", "step", "type", "params", "error_handler", "error_handler_params"],
"data": []
},
"item_parameter": {
"fields": ["item_parameterid", "itemid", "name", "value"],
"data": []
},
"globalmacro": {
"fields": ["globalmacroid", "macro", "value", "type"],
"data": [
[2, "${SNMP_COMMUNITY}", "public", 0]
]
},
"hosts_templates": {
"fields": ["hosttemplateid", "hostid", "templateid", "link_type"],
"data": []
},
"hostmacro": {
"fields": ["hostmacroid", "hostid", "macro", "value", "type", "automatic"],
"data": [
[5676, 10084, "${M}", "AppID=zabbix_server&Query=Safe=passwordSafe;Object=zabbix:Content", 2, 0]
]
},
"drules": {
"fields": ["druleid", "name", "iprange", "delay"],
"data": [
[2, "Local network", "127.0.0.1", "10s"]
]
},
"dchecks": {
"fields": ["dcheckid", "druleid", "type", "key_", "snmp_community", "ports", "snmpv3_securityname", "snmpv3_authname"],
"data": [
[2, 2, 9, "system.uname", "", "10052", "", 0, "", "", 0, 0, 0, "", 1, 0]
]
},
"regexps": {
"fields": ["regexpid", "name"],
"data": [
[1, "File systems for discovery"],
[2, "Network interfaces for discovery"],
[3, "Storage devices for SNMP discovery"],
[4, "Windows service names for discovery"],
[5, "Windows service startup states for discovery"]
]
},
"expressions": {
"fields": ["expressionid", "regexpid", "expression", "expression_type", "exp_delimiter", "case_sensitive"],
"data": [
[1, 1, "^(btrfs|ext2|ext3|ext4|reiser|xfs|ffs|ufs|jfs|jfs2|vxfs|hfs|apfs|refs|ntfs|fat32|zfs)$", 3, ",", 0],
[3, 3, "^(Physical memory|Virtual memory|Memory buffers|Cached memory|Swap space)$", 4, ",", 1],

```

```

[5, 4, "^((MMCSS|gupdate|SysmonLog|clr_optimization_v2.0.50727_32|clr_optimization_v4.0.30319_32)$", 4, "", 1],
[6, 5, "(automatic|automatic delayed)$", 3, "", 1],
[7, 2, "Software Loopback Interface", 4, "", 1],
[8, 2, "(In)?[Ll]oop[Bb]ack[0-9.]*$", 4, "", 1],
[9, 2, "NULL[0-9.]*$", 4, "", 1],
[10, 2, "[Ll]o[0-9.]*$", 4, "", 1],
[11, 2, "[Ss]ystem$", 4, "", 1],
[12, 2, "Nu[0-9.]*$", 4, "", 1]
]
},
"config": {
"fields": ["configid", "snmptrap_logging", "hk_history_global", "hk_history", "autoreg_tls_accept"],
"data": [
[1, 1, 0, "90d", 1]
]
},
"httpstest": {
"fields": ["httpstestid", "name", "delay", "agent", "authentication", "http_user", "http_password", "hostid"],
"data": []
},
"httpstestitem": {
"fields": ["httpstestitemid", "httpstestid", "itemid", "type"],
"data": []
},
"httpstest_field": {
"fields": ["httpstest_fieldid", "httpstestid", "type", "name", "value"],
"data": []
},
"httpstep": {
"fields": ["httpstepid", "httpstestid", "name", "no", "url", "timeout", "posts", "required", "status_codes"],
"data": []
},
"httpstepitem": {
"fields": ["httpstepitemid", "httpstepid", "itemid", "type"],
"data": []
},
"httpstep_field": {
"fields": ["httpstep_fieldid", "httpstepid", "type", "name", "value"],
"data": []
},
"config_autoreg_tls": {
"fields": ["autoreg_tlsid", "tls_psk_identity", "tls_psk"],
"data": [
[1, "", ""]
]
}
},
"macro.secrets": {
"AppID=zabbix_server&Query=Safe=passwordSafe;Object=zabbix": {
"Content": "738"
}
},
"config_revision": 2
}

```

Data request

The proxy data request is sent by proxy to provide host interface availability, history, discovery and autoregistration data. This request is sent every DataSenderFrequency (proxy configuration parameter) seconds. Note that active proxy will still poll Zabbix server every second for remote command tasks (with an empty proxy data request).

name	value type	description
proxy→server:		
request	string	'proxy data'
host	string	Proxy name.
session	string	Data session token.
interface	array	(optional) Array of interface availability data objects.
avail- abil- ity		
interfaceid	number	Interface identifier.
available	number	Interface availability: 0 , <i>INTERFACE_AVAILABLE_UNKNOWN</i> - unknown 1 , <i>INTERFACE_AVAILABLE_TRUE</i> - available 2 , <i>INTERFACE_AVAILABLE_FALSE</i> - unavailable
error	string	Interface error message or empty string.
history	array	(optional) Array of history data objects.
data		
itemid	number	Item identifier.
clock	number	Item value timestamp (seconds).
ns	number	Item value timestamp (nanoseconds).
value	string	(optional) Item value.
id	number	Value identifier (ascending counter, unique within one data session).
timestamp	number	(optional) Timestamp of log type items.
source	string	(optional) Eventlog item source value.
severity	number	(optional) Eventlog item severity value.
eventid	number	(optional) Eventlog item eventid value.
state	string	(optional) Item state: 0 , <i>ITEM_STATE_NORMAL</i> 1 , <i>ITEM_STATE_NOTSUPPORTED</i>
lastlogsize	number	(optional) Last log size of log type items.
mtime	number	(optional) Modification time of log type items.
discovery	array	(optional) Array of discovery data objects.
data		
clock	number	Discovery data timestamp.
druleid	number	Discovery rule identifier.
dcheckid	number	Discovery check identifier or null for discovery rule data.
type	number	Discovery check type: -1 discovery rule data 0 , <i>SVC_SSH</i> - SSH service check 1 , <i>SVC_LDAP</i> - LDAP service check 2 , <i>SVC_SMTP</i> - SMTP service check 3 , <i>SVC_FTP</i> - FTP service check 4 , <i>SVC_HTTP</i> - HTTP service check 5 , <i>SVC_POP</i> - POP service check 6 , <i>SVC_NNTP</i> - NNTP service check 7 , <i>SVC_IMAP</i> - IMAP service check 8 , <i>SVC_TCP</i> - TCP port availability check 9 , <i>SVC_AGENT</i> - Zabbix agent 10 , <i>SVC_SNMPv1</i> - SNMPv1 agent 11 , <i>SVC_SNMPv2</i> - SNMPv2 agent 12 , <i>SVC_ICMPping</i> - ICMP ping 13 , <i>SVC_SNMPv3</i> - SNMPv3 agent 14 , <i>SVC_HTTPS</i> - HTTPS service check 15 , <i>SVC_TELNET</i> - Telnet availability check
ip	string	Host IP address.
dns	string	Host DNS name.
port	number	(optional) Service port number.
key_	string	(optional) Item key for discovery check of type 9 <i>SVC_AGENT</i>
value	string	(optional) Value received from the service, can be empty for most services.

name	value type	description
status	number	(optional) Service status: 0 , <i>DOBJECT_STATUS_UP</i> - Service UP 1 , <i>DOBJECT_STATUS_DOWN</i> - Service DOWN
autoregistration	array	(optional) Array of autoregistration data objects.
clock	number	Autoregistration data timestamp.
host	string	Host name.
ip	string	(optional) Host IP address.
dns	string	(optional) Resolved DNS name from IP address.
port	string	(optional) Host port.
host_metadata	string	(optional) Host metadata sent by agent (based on HostMetadata or HostMetadataItem agent configuration parameter).
tasks	array	(optional) Array of tasks.
type	number	Task type: 0 , <i>ZBX_TM_TASK_PROCESS_REMOTE_COMMAND_RESULT</i> - remote command result
status	number	Remote-command execution status: 0 , <i>ZBX_TM_REMOTE_COMMAND_COMPLETED</i> - remote command completed successfully 1 , <i>ZBX_TM_REMOTE_COMMAND_FAILED</i> - remote command failed
error	string	(optional) Error message.
parent_taskid	number	Parent task ID.
more	number	(optional) 1 - there are more history data to send
clock	number	(optional) Data transfer timestamp (seconds).
ns	number	(optional) Data transfer timestamp (nanoseconds).
version	string	Proxy version (<major>.<minor>.<build>).
server→proxy:		
response	string	Request success information ('success' or 'failed').
upload	string	Upload control for historical data (history, autoregistration, host availability, network discovery). Possible values: enabled - normal operation disabled - server is not accepting data (possibly due to internal cache over limit)
tasks	array	(optional) Array of tasks.
type	number	Task type: 1 , <i>ZBX_TM_TASK_PROCESS_REMOTE_COMMAND</i> - remote command
clock	number	Task creation time.
ttd	number	Time in seconds after which the task expires.
commandtype	number	Remote-command type: 0 , <i>ZBX_SCRIPT_TYPE_CUSTOM_SCRIPT</i> - use custom script 1 , <i>ZBX_SCRIPT_TYPE_IPMI</i> - use IPMI 2 , <i>ZBX_SCRIPT_TYPE_SSH</i> - use SSH 3 , <i>ZBX_SCRIPT_TYPE_TELNET</i> - use Telnet 4 , <i>ZBX_SCRIPT_TYPE_GLOBAL_SCRIPT</i> - use global script (currently functionally equivalent to custom script)
command	string	Remote command to execute.
execute_on	number	Execution target for custom scripts: 0 , <i>ZBX_SCRIPT_EXECUTE_ON_AGENT</i> - execute script on agent 1 , <i>ZBX_SCRIPT_EXECUTE_ON_SERVER</i> - execute script on server 2 , <i>ZBX_SCRIPT_EXECUTE_ON_PROXY</i> - execute script on proxy
port	number	(optional) Port for Telnet and SSH commands.
authtype	number	(optional) Authentication type for SSH commands.
username	string	(optional) User name for Telnet and SSH commands.
password	string	(optional) Password for Telnet and SSH commands.

name	value type	description
publickey	<i>string</i>	(optional) Public key for SSH commands.
privatekey	<i>string</i>	(optional) Private key for SSH commands.
parent_taskid	<i>number</i>	Parent task ID.
hostid	<i>number</i>	Target host ID.

Example:

proxy→server:

```
{
  "request": "proxy data",
  "host": "Zabbix proxy",
  "session": "818cdd1b537bdc5e50c09ed4969235b6",
  "interface availability": [{
    "interfaceid": 1,
    "available": 1,
    "error": ""
  }],
  "history data": [{
    "id": 1114,
    "itemid": 44162,
    "clock": 1665730632,
    "ns": 798953105,
    "value": "1"
  }, {
    "id": 1115,
    "itemid": 44161,
    "clock": 1665730633,
    "ns": 811684663,
    "value": "58"
  }],
  "auto registration": [{
    "clock": 1665730633,
    "host": "Zabbix server",
    "ip": "127.0.0.1",
    "dns": "localhost",
    "port": "10053",
    "host_metadata": "58",
    "tls_accepted": 1
  }],
  "discovery data": [{
    "clock": 1665732232,
    "drule": 2,
    "dcheck": 2,
    "ip": "127.0.0.1",
    "dns": "localhost",
    "port": 10052,
    "status": 1
  }, {
    "clock": 1665732232,
    "drule": 2,
    "dcheck": null,
    "ip": "127.0.0.1",
    "dns": "localhost",
    "status": 1
  }],
  "host data": [{
    "hostid": 10084,
    "active_status": 1
  }],
  "tasks": [{
    "type": 3,
```

```

"clock": 1665730985,
"ttl": 0,
"status": -1,
"info": "Remote commands are not enabled",
"parent_taskid": 3
}],
"version": "7.4.0",
"clock": 1665730643,
"ns": 65389964
}

```

server→proxy:

```

{
"upload": "enabled",
"response": "success",
"tasks": [{
"type": 2,
"clock": 1665730986,
"ttl": 600,
"commandtype": 0,
"command": "ping -c 3 127.0.0.1; case $? in [01]) true;; *) false;; esac",
"execute_on": 2,
"port": 0,
"authtype": 0,
"username": "",
"password": "",
"publickey": "",
"privatekey": "",
>alertid": 0,
"parent_taskid": 4,
"hostid": 10084
}]
}

```

2 Zabbix agent/agent2 protocol

Please refer to [Passive and active agent checks](#) page for more information on Zabbix agent and Zabbix agent 2 protocols.

4 Zabbix agent 2 plugin protocol

Zabbix agent 2 protocol is based on code, size and data model.

Code

Type	Size	Comments
Byte	4	Payload type, currently only JSON is supported.

Size

Type	Size	Comments
Byte	4	Size of the current payload in bytes.

Payload data

Type	Size	Comments
Byte	Defined by the <i>Size</i> field	JSON formatted data.

Payload data definition

Common data

These parameters are present in all requests/responses:

Name	Type	Comments
id	uint32	For requests - the incrementing identifier used to link requests with responses. Unique within a request direction (i.e. from agent to plugin or from plugin to agent).
type	uint32	For responses - ID of the corresponding request. The request type.

Log request

A request sent by a plugin to write a log message into the agent log file.

direction	plugin → agent
response	no

Parameters specific to log requests:

Name	Type	Comments
severity	uint32	The message severity (log level).
message	string	The message to log.

Example:

```
{"id":0,"type":1,"severity":3,"message":"message"}
```

Register request

A request sent by the agent during the agent startup phase to obtain provided metrics to register a plugin.

direction	agent → plugin
response	yes

Parameters specific to register requests:

Name	Type	Comments
version	string	The protocol version <major>.<minor>

Example:

```
{"id":1,"type":2,"version":"1.0"}
```

Register response

Plugin's response to the register request.

direction	plugin → agent
response	n/a

Parameters specific to register responses:

Name	Type	Comments
name	string	The plugin name.
metrics	array of strings (optional)	The metrics with descriptions as used in the plugin. Returns RegisterMetrics(). Absent if error is returned.

Name	Type	Comments
interfaces	uint32 (optional)	The bit mask of plugin's supported interfaces. Absent if error is returned.
error	string (optional)	An error message returned if a plugin cannot be started. Absent, if metrics are returned.

Examples:

```
{"id":2,"type":3,"metrics":["external.test", "External exporter Test."], "interfaces": 4}
```

or

```
{"id":2,"type":3,"error":"error message"}
```

Start request

A request to execute the Start function of the Runner interface.

direction	agent → plugin
response	no

The request doesn't have specific parameters, it only contains **common data** parameters.

Example:

```
{"id":3,"type":4}
```

Terminate request

A request sent by the agent to shutdown a plugin.

direction	agent → plugin
response	no

The request doesn't have specific parameters, it only contains **common data** parameters.

Example:

```
{"id":3,"type":5}
```

Export request

A request to execute the Export function of the Exporter interface.

direction	agent → plugin
response	no

Parameters specific to export requests:

Name	Type	Comments
key	string	The plugin key.
parameters	array of strings (optional)	The parameters for Export function.

Example:

```
{"id":4,"type":6,"key":"test.key","parameters":["foo","bar"]}
```

Export response

Response from the Export function of the Exporter interface.

direction	plugin → agent
response	n/a

Parameters specific to export responses:

Name	Type	Comments
value	string (optional)	Response value from the Export function. Absent, if error is returned.
error	string (optional)	Error message if the Export function has not been executed successfully. Absent, if value is returned.

Examples:

```
{"id":5,"type":7,"value":"response"}
```

or

```
{"id":5,"type":7,"error":"error message"}
```

Configure request

A request to execute the *Configure* function of the *Configurator* interface.

direction	agent → plugin
response	n/a

Parameters specific to *Configure* requests:

Name	Type	Comments
global_options	JSON object	JSON object containing global agent configuration options.
private_options	JSON object (optional)	JSON object containing private plugin configuration options, if provided.

Example:

```
{"id":6,"type":8,"global_options":{...},"private_options":{...}}
```

Validate request

A request to execute *Validate* function of the *Configurator* interface.

direction	agent → plugin
response	yes

Parameters specific to *Validate* requests:

Name	Type	Comments
private_options	JSON object (optional)	JSON object containing private plugin configuration options, if provided.

Example:

```
{"id":7,"type":9,"private_options":{...}}
```

Validate response

Response from *Validate* function of *Configurator* interface.

direction	plugin → agent
response	n/a

Parameters specific to *Validate* responses:

Name	Type	Comments
error	string (optional)	An error message returned if the Validate function is not executed successfully. Absent if executed successfully.

Example:

```
{"id":8,"type":10}
```

or

```
{"id":8,"type":10,"error":"error message"}
```

5 Zabbix sender protocol

Overview

Zabbix server and Zabbix proxy use a JSON-based communication protocol for receiving data from Zabbix sender. Data can be received with the help of a [trapper item](#), or an [HTTP agent item](#) with trapping enabled.

Request and response messages must begin with [header and data length](#).

Zabbix sender request

```
{
  "request": "sender data",
  "data": [
    {
      "host": "<hostname>",
      "key": "trap",
      "value": "test value"
    }
  ]
}
```

Zabbix server response

```
{
  "response": "success",
  "info": "processed: 1; failed: 0; total: 1; seconds spent: 0.060753"
}
```

Zabbix sender request with a timestamp

Alternatively, Zabbix sender can send a request with a timestamp and nanoseconds.

```
{
  "request": "sender data",
  "data": [
    {
      "host": "<hostname>",
      "key": "trap",
      "value": "test value",
      "clock": 1516710794,
      "ns": 592397170
    },
    {
      "host": "<hostname>",
      "key": "trap",
      "value": "test value",
      "clock": 1516710795,
      "ns": 192399456
    }
  ],
  "clock": 1516712029,
  "ns": 873386094
}
```

Zabbix server response

```
{
  "response": "success",
  "info": "processed: 2; failed: 0; total: 2; seconds spent: 0.060904"
}
```

6 Header

Overview

The header is present in all request and response messages between Zabbix components. It is required to determine the message length, if it is compressed or not, if it is a large packet or not.

Zabbix communications protocol has 1GB packet size limit per connection. The limit of 1GB is applied to both the received packet data length and the uncompressed data length.

When sending configuration to Zabbix proxy, the packet size limit is increased to 4GB to allow syncing large configurations. When data length before compression exceeds 4GB, Zabbix server automatically starts using the large packet format (0x04 flag) which increases the packet size limit to 16GB.

Note that while a large packet format can be used for sending any data, currently only the Zabbix proxy configuration syncer can handle packets that are larger than 1GB.

Structure

The header consists of four fields. All numbers in the header are formatted as little-endian.

Field	Size	Size (large packet)	Description
<PROTOCOL>	4	4	"ZBXD" or 5A 42 58 44
<FLAGS>	1	1	Protocol flags: 0x01 - Zabbix communications protocol 0x02 - compression 0x04 - large packet
<DATALEN>	4	8	Data length.
<RESERVED>	4	8	When compression is used (0x02 flag) - the length of uncompressed data When compression is not used - 00 00 00 00

Examples

Here are some code snippets showing how to add Zabbix protocol header to the data you want to send in order to obtain the packet you should send to Zabbix so that it is interpreted correctly. These code snippets assume that the data is not larger than 1GB, thus the large packet format is not used.

Python

```
packet = b"ZBXD\1" + struct.pack("<II", len(data), 0) + data
```

or

```
def zbx_create_header(plain_data_size, compressed_data_size=None):
    protocol = b"ZBXD"
    flags = 0x01
    if compressed_data_size is None:
        datalen = plain_data_size
        reserved = 0
    else:
        flags |= 0x02
        datalen = compressed_data_size
        reserved = plain_data_size
    return protocol + struct.pack("<BII", flags, datalen, reserved)
```

```
packet = zbx_create_header(len(data)) + data
```

Perl

```
my $packet = "ZBXD\1" . pack("(II)<", length($data), 0) . $data;
```

or

```
sub zbx_create_header($;$)
{
    my $plain_data_size = shift;
    my $compressed_data_size = shift;

    my $protocol = "ZBXD";
    my $flags = 0x01;
    my $datalen;
    my $reserved;

    if (!defined($compressed_data_size))
    {
        $datalen = $plain_data_size;
        $reserved = 0;
    }
    else
    {
        $flags |= 0x02;
        $datalen = $compressed_data_size;
        $reserved = $plain_data_size;
    }

    return $protocol . chr($flags) . pack("(II)<", $datalen, $reserved);
}

my $packet = zbx_create_header(length($data)) . $data;
```

PHP

```
$packet = "ZBXD\1" . pack("VV", strlen($data), 0) . $data;
```

or

```
function zbx_create_header($plain_data_size, $compressed_data_size = null)
{
    $protocol = "ZBXD";
    $flags = 0x01;
    if (is_null($compressed_data_size))
    {
        $datalen = $plain_data_size;
        $reserved = 0;
    }
    else
    {
        $flags |= 0x02;
        $datalen = $compressed_data_size;
        $reserved = $plain_data_size;
    }
    return $protocol . chr($flags) . pack("VV", $datalen, $reserved);
}

$packet = zbx_create_header(strlen($data)) . $data;
```

Bash

```
datalen=$(printf "%08x" ${#data})
datalen="\x${datalen:6:2}\x${datalen:4:2}\x${datalen:2:2}\x${datalen:0:2}"
printf "ZBXD\1${datalen}\0\0\0\0%s" "$data"
```

7 Newline-delimited JSON export protocol

This section presents details of the export protocol in a newline-delimited JSON format, used in:

- [data export to files](#)
- [streaming to external systems](#)

The following can be exported:

- [trigger events](#)
- [item values](#)
- [trends](#) (export to files only)

All files have a `.ndjson` extension. Each line of the export file is a JSON object.

Trigger events

The following information is exported for a problem event:

Field	Type	Description
<i>clock</i>	number	Number of seconds since Epoch to the moment when problem was detected (integer part).
<i>ns</i>	number	Number of nanoseconds to be added to <i>clock</i> to get a precise problem detection time.
<i>value</i>	number	1 (always).
<i>eventid</i>	number	Problem event ID.
<i>name</i>	string	Problem event name.
<i>severity</i>	number	Problem event severity (0 - Not classified, 1 - Information, 2 - Warning, 3 - Average, 4 - High, 5 - Disaster).
<i>hosts</i>	array	List of hosts involved in the trigger expression; there should be at least one element in array.
-	object	
-	string	Host name.
-	string	Visible host name.
<i>groups</i>	array	List of host groups of all hosts involved in the trigger expression; there should be at least one element in array.
-	string	Host group name.
<i>tags</i>	array	List of problem tags (can be empty).
-	object	
-	string	Tag name.
-	string	Tag value (can be empty).

The following information is exported for a recovery event:

Field	Type	Description
<i>clock</i>	number	Number of seconds since Epoch to the moment when problem was resolved (integer part).
<i>ns</i>	number	Number of nanoseconds to be added to <i>clock</i> to get a precise problem resolution time.
<i>value</i>	number	0 (always).
<i>eventid</i>	number	Recovery event ID.
<i>p_eventid</i>	number	Problem event ID.

Examples

Problem:

```
{"clock":1519304285,"ns":123456789,"value":1,"name":"Either Zabbix agent is unreachable on Host B or polle
```

Recovery:

```
{"clock":1519304345,"ns":987654321,"value":0,"eventid":43,"p_eventid":42}
```

Problem (multiple problem event generation):

```
{"clock":1519304286,"ns":123456789,"value":1,"eventid":43,"name":"Either Zabbix agent is unreachable on Ho
```

```
{"clock":1519304286,"ns":123456789,"value":1,"eventid":43,"name":"Either Zabbix agent is unreachable on Ho
```

Recovery:

```
{"clock":1519304346,"ns":987654321,"value":0,"eventid":44,"p_eventid":43}
```

```
{"clock":1519304346,"ns":987654321,"value":0,"eventid":44,"p_eventid":42}
```

Item values

The following information is exported for a collected item value:

Field	Type	Description
<i>host</i>	object	Host name of the item host.
<i>host</i>	string	Host name.
<i>name</i>	string	Visible host name.
<i>groups</i>	array	List of host groups of the item host; there should be at least one element in array.
-	string	Host group name.
<i>item_tags</i>	array	List of item tags (can be empty).
-	object	
<i>tag</i>	string	Tag name.
<i>value</i>	string	Tag value (can be empty).
<i>itemid</i>	number	Item ID.
<i>name</i>	string	Visible item name.
<i>clock</i>	number	Number of seconds since Epoch to the moment when value was collected (integer part).
<i>ns</i>	number	Number of nanoseconds to be added to <i>clock</i> to get a precise value collection time.
<i>timestamp</i> (Log only)	number	0 if not available.
<i>source</i> (Log only)	string	Empty string if not available.
<i>severity</i> (Log only)	number	0 if not available.
<i>eventid</i> (Log only)	number	0 if not available.
<i>value</i>	number (for numeric items) or string (for text items)	Collected item value.
<i>type</i>	number	Collected value type: 0 - numeric float, 1 - character, 2 - log, 3 - numeric unsigned, 4 - text, 5 - binary

Examples

Numeric (unsigned) value:

```
{"host":{"host":"Host B","name":"Host B visible"},"groups":["Group X","Group Y","Group Z"],"item_tags":[{"
```

Numeric (float) value:

```
{"host":{"host":"Host B","name":"Host B visible"},"groups":["Group X","Group Y","Group Z"],"item_tags":[{"
```

Character, text value:

```
{"host":{"host":"Host B","name":"Host B visible"},"groups":["Group X","Group Y","Group Z"],"item_tags":[{"
```

Log value:

```
{"host":{"host":"Host A","name":"Host A visible"},"groups":["Group X","Group Y","Group Z"],"item_tags":[{"
```

Trends

The following information is exported for a calculated trend value:

Field	Type	Description
<i>host</i>	object	Host name of the item host.
<i>host</i>	string	Host name.
<i>name</i>	string	Visible host name.
<i>groups</i>	array	List of host groups of the item host; there should be at least one element in array.
-	string	Host group name.
<i>item_tags</i>	array	List of item tags (can be empty).
-	object	
<i>tag</i>	string	Tag name.
<i>value</i>	string	Tag value (can be empty).
<i>itemid</i>	number	Item ID.
<i>name</i>	string	Visible item name.
<i>clock</i>	number	Number of seconds since Epoch to the moment when value was collected (integer part).
<i>count</i>	number	Number of values collected for a given hour.
<i>min</i>	number	Minimum item value for a given hour.
<i>avg</i>	number	Average item value for a given hour.
<i>max</i>	number	Maximum item value for a given hour.
<i>type</i>	number	Value type: 0 - numeric float, 3 - numeric unsigned

Examples

Numeric (unsigned) value:

```
{"host":{"host":"Host B","name":"Host B visible"},"groups":["Group X","Group Y","Group Z"],"item_tags": [{"
```

Numeric (float) value:

```
{"host":{"host":"Host B","name":"Host B visible"},"groups":["Group X","Group Y","Group Z"],"item_tags": [{"
```

4 Items

Please use the sidebar to access content in this section.

1 vm.memory.size parameters

Overview

This section provides some parameter details for the `vm.memory.size[<mode>]` agent item.

Parameters

The following parameters are available for this item:

- **active** - memory currently in use or very recently used, and so it is in RAM
- **anon** - memory not associated with a file (cannot be re-read from it)
- **available** - available memory, calculated differently depending on the platform (see the table below)
- **buffers** - cache for things like file system metadata
- **cached** - cache for various things
- **exec** - executable code, typically from a (program) file
- **file** - cache for contents of recently accessed files
- **free** - memory that is readily available to any entity requesting memory
- **inactive** - memory that is marked as not used
- **pavailable** - 'available' memory as percentage of 'total' (calculated as $\text{available}/\text{total}*100$)
- **pinned** - same as 'wired'
- **pusd** - 'used' memory as percentage of 'total' (calculated as $\text{used}/\text{total}*100$)
- **shared** - memory that may be simultaneously accessed by multiple processes

- **slab** - total amount of memory used by the kernel to cache data structures for its own use
- **total** - total physical memory available
- **used** - used memory, calculated differently depending on the platform (see the table below)
- **wired** - memory that is marked to always stay in RAM. It is never moved to disk.

Warning:

Some of these parameters are platform-specific and might not be available on your platform. See [Zabbix agent items](#) for details.

Platform-specific calculation of **available** and **used**:

Platform	"available"	"used"
AIX	free + cached	real memory in use
FreeBSD	inactive + cached + free	active + wired + cached
HP UX	free	total - free
Linux<3.14	free + buffers + cached	total - free
Linux 3.14+ (also backported to 3.10 on RHEL 7)	/proc/meminfo, see "MemAvailable" in Linux kernel documentation for details. Note that free + buffers + cached is no longer equal to 'available' due to not all the page cache can be freed and low watermark being used in calculation.	total - free
NetBSD	inactive + execpages + file + free	total - free
OpenBSD	inactive + free + cached	active + wired
OSX	inactive + free	active + wired
Solaris	free	total - free
Win32	free	total - free

Attention:

The sum of `vm.memory.size[used]` and `vm.memory.size[available]` does not necessarily equal total. For instance, on FreeBSD:

- * Active, inactive, wired, cached memories are considered used, because they store some useful information.
- * At the same time inactive, cached, free memories are considered available, because these kinds of memories can be given instantly to processes that request more memory.

So inactive memory is both used and available simultaneously. Because of this, the `vm.memory.size[used]` item is designed for informational purposes only, while `vm.memory.size[available]` is designed to be used in triggers.

See also

1. [Additional details about memory calculation in different OS](#)

2 Passive and active agent checks

Overview

This section provides details on passive and active checks performed by [Zabbix agent](#) and [Zabbix agent 2](#).

Zabbix uses a JSON-based communication protocol for communicating with the agents.

Zabbix agent and Zabbix agent 2 protocols have been unified since Zabbix 7.0. The difference between Zabbix agent and Zabbix agent 2 requests/responses is expressed by the "variant" tag value.

Passive checks

A passive check is a simple data request. Zabbix server or proxy asks for some data (for example, CPU load) and Zabbix agent sends back the result to the server.

Passive checks are executed asynchronously - it is not required to receive the response to one request before other checks are started. DNS resolving is asynchronous as well.

The maximum concurrency of asynchronous checks is 1000 (defined by [MaxConcurrentChecksPerPoller](#)).

The number of asynchronous agent pollers is defined by the [StartAgentPollers](#) parameter.

Server request

For definition of header and data length please refer to [protocol details](#).

```
{
  "request": "passive checks",
  "data": [
    {
      "key": "agent.version",
      "timeout": 3
    }
  ]
}
```

Agent response

```
{
  "version": "7.4.0",
  "variant": 2,
  "data": [
    {
      "value": "7.4.0"
    }
  ]
}
```

For example, for supported items:

1. Server opens a TCP connection
2. Server sends **<HEADER><DATALEN>{"request":"passive checks","data":[{"key":"agent.ping","timeout":3}]}**
3. Agent reads the request and responds with **<HEADER><DATALEN>{"version":"7.4.0","variant":2,"data":[{"value":1}]}**
4. Server processes data to get the value, '1' in our case
5. TCP connection is closed

For not supported items:

1. Server opens a TCP connection
2. Server sends **<HEADER><DATALEN>{"request":"passive checks","data":[{"key":"vfs.fs.size[/nono]","timeout":3}]}**
3. Agent reads the request and responds with **<HEADER><DATALEN>{"version":"7.4.0","variant":2,"data":[{"error":"Unsupported item key."}]}**
4. Server processes data, changes item state to not supported with the specified error message
5. TCP connection is closed

Failover to old protocol

To make sure that Zabbix server or proxy can work with agents from pre-7.2 versions, which have plaintext protocol, a failover to the old protocol is implemented.

Passive checks are performed using the JSON protocol (7.2 and later) after restart or when the interface configuration is changed. If no valid JSON is received in response (agent sent "ZBX_NOTSUPPORTED"), Zabbix will cache the interface as old protocol and **retry** the check by sending only the item key.

Note that every hour Zabbix server/proxy will again try working with the new protocol with all interfaces, falling back to the old protocol if required.

Active checks

Active checks require more complex processing. The agent must first retrieve from the server/proxy a list of items and/or **remote commands** for independent processing.

The servers/proxies to get the active checks from are listed in the 'ServerActive' parameter of the agent **configuration file**. The frequency of asking for these checks is set by the 'RefreshActiveChecks' parameter in the same configuration file. However, if refreshing active checks fails, it is retried after hardcoded 60 seconds.

Note:

Since Zabbix 6.4 the agent (in active mode) no longer receives from the server/proxy a full copy of the configuration once every two minutes (default). Instead, in order to decrease network traffic and resources usage, an incremental configuration sync is performed every 5 seconds (default) upon which the server/proxy provides a full copy of the configuration **only** if the agent has not yet received it, or something has changed in host configuration, global macros or global regular expressions.

The agent then periodically sends the new values to the server(s). If the agent received any **remote commands** to execute, the execution result will also be sent. Note that remote command execution on an active agent is supported since Zabbix agent 7.0.

Note:

If an agent is behind the firewall you might consider using only Active checks because in this case you wouldn't need to modify the firewall to allow initial incoming connections.

Getting the list of items

Agent request

The active checks request is used to obtain the active checks to be processed by agent. This request is sent by the agent upon start and then with **RefreshActiveChecks** intervals.

```
{
  "request": "active checks",
  "host": "Zabbix server",
  "host_metadata": "mysql,nginx",
  "hostinterface": "zabbix.server.lan",
  "ip": "159.168.1.1",
  "port": 12050,
  "version": "7.4.0",
  "variant": 2,
  "config_revision": 1,
  "session": "e3dcdbd9ace2c9694e1d7bbd030eeef6e"
}
```

Field	Type	Mandatory	Value
request	string	yes	active checks
host	string	yes	Host name.
host_metadata	string	no	The configuration parameter HostMetadata or HostMetadataItem metric value.
hostinterface	string	no	The configuration parameter HostInterface or HostInterfaceItem metric value.
ip	string	no	The configuration parameter ListenIP first IP if set.
port	number	no	The configuration parameter ListenPort value if set and not default agent listening port.
version	string	yes	The agent version number.
variant	number	yes	The agent variant (1 - Zabbix agent, 2 - Zabbix agent 2).
config_revision	number	no	Configuration identifier for incremental configuration sync .
session	string	no	Session identifier for incremental configuration sync .

Server response

The active checks response is sent by the server back to agent after processing the active checks request.

```
{
  "response": "success",
  "config_revision": 2,
  "data": [
    {
      "key": "system.uptime",
      "itemid": 1234,
      "delay": "10s",
      "lastlogsize": 0,
      "mtime": 0
    },
    {
      "key": "agent.version",
      "itemid": 5678,
      "delay": "10m",
      "lastlogsize": 0,
      "mtime": 0,
      "timeout": "30s"
    }
  ]
}
```

```

"commands": [
  {
    "command": "df -h --output=source,size / | awk 'NR>1 {print $2}'",
    "id": 1324,
    "wait": 1
  }
]
}

```

Field	Type	Mandatory	Value
response	string	yes	success failed
info	string	no	Error information in case of failure.
data	array	no	Active check items. Omitted if host configuration is unchanged.
	of objects		
key	string	no	Item key with expanded macros.
itemid	number	no	Item identifier.
delay	string	no	Item update interval.
			Flexible/scheduling intervals are supported by both Zabbix agent and Zabbix agent 2 since Zabbix 7.0.
lastlogsize	number	no	Item lastlogsize.
mtime	number	no	Item mtime.
timeout	string	no	Item timeout.
refresh_unsupported	number	no	Unsupported item refresh interval.
regexp	array	no	Global regular expressions.
	of objects		
name	string	no	Global regular expression name.
expression	string	no	Global regular expression.
expression_type	number	no	Global regular expression type.
exp_delimiter	string	no	Global regular expression delimiter.
case_sensitive	number	no	Global regular expression case sensitivity setting.
commands	array	no	Remote commands to execute. Included if remote command execution has been triggered by an action operation or manual script execution. Note that remote command execution on an active agent is supported since Zabbix agent 7.0. Older active agents will ignore any remote commands included in the active checks server response.
	of objects		
command	string	no	Remote command.
id	number	no	Remote command identifier.
wait	number	no	Remote command mode of execution ("0" (nowait) for commands from action operations ; "1" (wait) for commands from manual script execution).
config_revision	number	no	Configuration identifier for incremental configuration sync . Omitted if host configuration is unchanged. Incremented if host configuration is changed.

The server must respond with success.

For example:

1. Agent opens a TCP connection
2. Agent asks for the list of checks
3. Server responds with a list of items and remote commands to execute
4. Agent parses the response
5. TCP connection is closed
6. Agent starts periodical collection of data and executes remote commands (supported since Zabbix agent 7.0)

Attention:

Note that (sensitive) configuration data may become available to parties having access to the Zabbix server trapper port when using an active check. This is possible because anyone may pretend to be an active agent and request item configuration data; authentication does not take place unless you use **encryption** options.

Sending in collected data

Agent sends

The agent data request contains the gathered item values and the values for executed remote commands (if any).

```
{
  "request": "agent data",
  "data": [
    {
      "id": 1,
      "itemid": 5678,
      "value": "7.0.0",
      "clock": 1712830783,
      "ns": 76808644
    },
    {
      "id": 2,
      "itemid": 1234,
      "value": "69672",
      "clock": 1712830783,
      "ns": 77053975
    }
  ],
  "commands": [
    {
      "id": 1324,
      "value": "16G"
    }
  ],
  "session": "1234456akdsjhfoi",
  "host": "Zabbix server",
  "version": "7.4.0",
  "variant": 2
}
```

Field	Type	Mandatory	Description
request	string	yes	agent data
data	array of objects	yes	Item values.
id	number	yes	The value identifier (incremental counter used for checking duplicated values in the case of network problems).
itemid	string	yes	The item identifier.
value	string	no	The item value.
lastlogsize	number	no	The item lastlogsize.
mtime	number	no	The item mtime.
state	number	no	The item state.
source	string	no	The value event log source.
eventid	number	no	The value event log eventid.
severity	number	no	The value event log severity.
timestamp	number	no	The value event log timestamp.
clock	number	yes	The value timestamp (seconds since Epoch).
ns	number	yes	The value timestamp nanoseconds.
commands	array of objects	no	Remote commands execution result. Note that remote command execution on an active agent is supported since Zabbix agent 7.0. Older active agents will ignore any remote commands included in the active checks server response.
id	number	no	Remote command identifier.
value	string	no	Remote command execution result if the execution was successful.
error	string	no	Remote command execution error message if the execution failed.
session	string	yes	Unique session identifier generated each time when agent is started.
host	string	yes	Host name.
version	string	yes	The agent version number.
variant	number	yes	The agent variant (1 - Zabbix agent, 2 - Zabbix agent 2).

A virtual ID is assigned to each value. Value ID is a simple ascending counter, unique within one data session (identified by the

session token). This ID is used to discard duplicate values that might be sent in poor connectivity environments.

Server response

The agent data response is sent by the server back to the agent after processing the agent data request.

```
{  
  "response": "success",  
  "info": "processed: 2; failed: 0; total: 2; seconds spent: 0.003534"  
}
```

Field	Type	Mandatory	Value
response	string	yes	success failed
info	string	yes	Item processing results.

Attention:

If sending of some values fails on the server (for example, because host or item has been disabled or deleted), agent will not retry sending of those values.

For example:

1. Agent opens a TCP connection
2. Agent sends a list of values
3. Server processes the data and sends the status back
4. TCP connection is closed

Note how in the example above the not supported status for `vfs.fs.size[/nono]` is indicated by the "state" value of 1 and the error message in "value" property.

Attention:

Error message will be trimmed to 2048 symbols on server side.

Heartbeat message

The heartbeat message is sent by an active agent to Zabbix server/proxy every `HeartbeatFrequency` seconds (configured in the [Zabbix agent/ agent 2](#) configuration file).

It is used to monitor the availability of active checks.

```
{  
  "request": "active check heartbeat",  
  "host": "Zabbix server",  
  "heartbeat_freq": 60,  
  "version": "7.4.0",  
  "variant": 2  
}
```

Field	Type	Mandatory	Value
request	string	yes	active check heartbeat
host	string	yes	The host name.
heartbeat_freq	number	yes	The agent heartbeat frequency (<code>HeartbeatFrequency</code> configuration parameter).
version	string	yes	The agent version number.
variant	number	yes	The agent variant (1 - Zabbix agent, 2 - Zabbix agent 2).

Older XML protocol

Note:

Zabbix will take up to 16 MB of XML Base64-encoded data, but a single decoded value should be no longer than 64 KB otherwise it will be truncated to 64 KB while decoding.

3 Minimum permission level for Windows agent items

Overview

When monitoring systems using an agent, a good practice is to obtain metrics from the host on which the agent is installed. To use the principle of least privilege, it is necessary to determine what metrics are obtained from the agent.

The table in this document allows you to select the minimum rights for guaranteed correct operation of Zabbix agent.

If a different user is selected for the agent to work, rather than 'LocalSystem', then for the operation of agent as a Windows service, the new user must have the rights "Log on as a service" from "Local Policy→User Rights Assignment" and the right to create, write and delete the Zabbix agent log file. An Active Directory user must be added to the *Performance Monitor Users* group.

Note:

When working with the rights of an agent based on the "minimum technically acceptable" group, prior provision of rights to objects for monitoring is required.

Common agent items supported on Windows

Item key	User group	
	Recommended	Minimum technically acceptable (functionality is limited)
agent.hostname	Guests	Guests
agent.ping	Guests	Guests
agent.variant	Guests	Guests
agent.version	Guests	Guests
log	Administrators	Guests
log.count	Administrators	Guests
logrt	Administrators	Guests
logrt.count	Administrators	Guests
net.dns	Guests	Guests
net.dns.perf	Guests	Guests
net.dns.record	Guests	Guests
net.if.discovery	Guests	Guests
net.if.in	Guests	Guests
net.if.out	Guests	Guests
net.if.total	Guests	Guests
net.tcp.listen	Guests	Guests
net.tcp.port	Guests	Guests
net.tcp.service	Guests	Guests
net.tcp.service.perf	Guests	Guests
net.udp.service	Guests	Guests
net.udp.service.perf	Guests	Guests
proc.num	Administrators	Guests
system.cpu.discovery	Performance Monitor Users	Performance Monitor Users
system.cpu.load	Performance Monitor Users	Performance Monitor Users
system.cpu.num	Guests	Guests
system.cpu.util	Performance Monitor Users	Performance Monitor Users
system.hostname	Guests	Guests
system.localtime	Guests	Guests
system.run	Administrators	Guests
system.sw.arch	Guests	Guests
system.swap.size	Guests	Guests
system.uptime	Performance Monitor Users	Performance Monitor Users
system.uptime	Performance Monitor Users	Performance Monitor Users
vfs.dir.count	Administrators	Guests
vfs.dir.get	Administrators	Guests
vfs.dir.size	Administrators	Guests
vfs.file.cksum	Administrators	Guests
vfs.file.contents	Administrators	Guests
vfs.file.exists	Administrators	Guests
vfs.file.md5sum	Administrators	Guests
vfs.file.regexp	Administrators	Guests
vfs.file.regmatch	Administrators	Guests

Item key	User group	
vfs.file.size	Administrators	Guests
vfs.file.time	Administrators	Guests
vfs.fs.discovery	Administrators	Guests
vfs.fs.size	Administrators	Guests
vfs.fs.get	Administrators	Guests
vm.memory.size	Guests	Guests
web.page.get	Guests	Guests
web.page.perf	Guests	Guests
web.page.regex	Guests	Guests
zabbix.stats	Guests	Guests

Windows-specific item keys

Item key	User group	
	Recommended	Minimum technically acceptable (functionality is limited)
eventlog	Event Log Readers	Guests
net.if.list	Guests	Guests
perf_counter	Performance Monitor Users	Performance Monitor Users
proc_info	Administrators	Guests
service.discovery	Guests	Guests
service.info	Guests	Guests
services	Guests	Guests
wmi.get	Administrators	Guests
vm.vmemory.size	Guests	Guests

4 Encoding of returned values

Zabbix server expects every returned text value in the UTF8 encoding. This is related to any type of checks: Zabbix agent, SSH, Telnet, etc.

Different monitored systems/devices and checks can return non-ASCII characters in the value. For such cases, almost all possible **zabbix** keys contain an additional item key parameter - **<encoding>**. This key parameter is optional but it should be specified if the returned value is not in the UTF8 encoding and it contains non-ASCII characters. Otherwise the result can be unexpected and unpredictable.

A description of behavior with different database backends in such cases follows.

MySQL

If a value contains a non-ASCII character in non UTF8 encoding - this character and the following will be discarded when the database stores this value. No warning messages will be written to the *zabbix_server.log*.

Relevant for at least MySQL version 5.1.61

PostgreSQL

If a value contains a non-ASCII character in non UTF8 encoding - this will lead to a failed SQL query (PGRES_FATAL_ERROR:ERROR invalid byte sequence for encoding) and data will not be stored. An appropriate warning message will be written to the *zabbix_server.log*.

Relevant for at least PostgreSQL version 9.1.3

5 Large file support

Large file support, often abbreviated to LFS, is the term applied to the ability to work with files larger than 2 GB on 32-bit operating systems. Support for large files affects at least **log file monitoring** and all **vfs.file.*** items. Large file support depends on the capabilities of a system at Zabbix compilation time, but is completely disabled on a 32-bit Solaris due to its incompatibility with `procfs` and `swapctl`.

6 Sensor

Each sensor chip gets its own directory in the `sysfs /sys/devices` tree. To find all sensor chips, it is easier to follow the device symlinks from `/sys/class/hwmon/hwmon*`, where `*` is a real number (0,1,2,...).

The sensor readings are located either in `/sys/class/hwmon/hwmon*/` directory for virtual devices, or in `/sys/class/hwmon/hwmon*/device` directory for non-virtual devices. A file, called `name`, located inside `hwmon*` or `hwmon*/device` directories contains the name of the chip, which corresponds to the name of the kernel driver used by the sensor chip.

There is only one sensor reading value per file. The common scheme for naming the files that contain sensor readings inside any of the directories mentioned above is: `<type><number>_<item>`, where

- **type** - for sensor chips is "in" (voltage), "temp" (temperature), "fan" (fan), etc.,
- **item** - "input" (measured value), "max" (high threshold), "min" (low threshold), etc.,
- **number** - always used for elements that can be present more than once (usually starts from 1, except for voltages which start from 0). If files do not refer to a specific element they have a simple name with no number.

The information regarding sensors available on the host can be acquired using **sensor-detect** and **sensors** tools (lm-sensors package: <http://lm-sensors.org/>). **Sensors-detect** helps to determine which modules are necessary for available sensors. When modules are loaded the **sensors** program can be used to show the readings of all sensor chips. The labeling of sensor readings, used by this program, can be different from the common naming scheme (`<type><number>_<item>`):

- if there is a file called `<type><number>_label`, then the label inside this file will be used instead of `<type><number><item>` name;
- if there is no `<type><number>_label` file, then the program searches inside the `/etc/sensors.conf` (could be also `/etc/sensors3.conf`, or different) for the name substitution.

This labeling allows user to determine what kind of hardware is used. If there is neither `<type><number>_label` file nor label inside the configuration file the type of hardware can be determined by the name attribute (`hwmon*/device/name`). The actual names of sensors, which zabbix_agent accepts, can be obtained by running **sensors** program with `-u` parameter (**sensors -u**).

In **sensor** program the available sensors are separated by the bus type (ISA adapter, PCI adapter, SPI adapter, Virtual device, ACPI interface, HID adapter).

On Linux 2.4:

(Sensor readings are obtained from `/proc/sys/dev/sensors` directory)

- **device** - device name (if `<mode>` is used, it is a regular expression);
- **sensor** - sensor name (if `<mode>` is used, it is a regular expression);
- **mode** - possible values: avg, max, min (if this parameter is omitted, device and sensor are treated verbatim).

Example key: `sensor[w83781d-i2c-0-2d,temp1]`

On Linux 2.6+:

(Sensor readings are obtained from `/sys/class/hwmon` directory)

- **device** - device name (non regular expression). The device name could be the actual name of the device (e.g 0000:00:18.3) or the name acquired using sensors program (e.g. k8temp-pci-00c3). It is up to the user to choose which name to use;
- **sensor** - sensor name (non regular expression);
- **mode** - possible values: avg, max, min (if this parameter is omitted, device and sensor are treated verbatim).

Example key:

`sensor[k8temp-pci-00c3,temp,max]` or `sensor[0000:00:18.3,temp1]`

`sensor[sm5c47b397-isa-0880,in,avg]` or `sensor[sm5c47b397.2176,in1]`

Obtaining sensor names

Sensor labels, as printed by the `sensors` command, cannot always be used directly because the naming of labels may be different for each sensor chip vendor. For example, `sensors` output might contain the following lines:

```
$ sensors
in0:          +2.24 V (min = +0.00 V, max = +3.32 V)
Vcore:       +1.15 V (min = +0.00 V, max = +2.99 V)
+3.3V:       +3.30 V (min = +2.97 V, max = +3.63 V)
+12V:        +13.00 V (min = +0.00 V, max = +15.94 V)
M/B Temp:    +30.0°C (low = -127.0°C, high = +127.0°C)
```

Out of these, only one label may be used directly:

```
$ zabbix_get -s 127.0.0.1 -k sensor[lm85-i2c-0-2e,in0]
2.240000
```

Attempting to use other labels (like `Vcore` or `+12V`) will not work.

```
$ zabbix_get -s 127.0.0.1 -k sensor[lm85-i2c-0-2e,Vcore]
ZBX_NOTSUPPORTED
```

To find out the actual sensor name, which can be used by Zabbix to retrieve the sensor readings, run `sensors -u`. In the output, the following may be observed:

```
$ sensors -u
...
Vcore:
  in1_input: 1.15
  in1_min: 0.00
  in1_max: 2.99
  in1_alarm: 0.00
...
+12V:
  in4_input: 13.00
  in4_min: 0.00
  in4_max: 15.94
  in4_alarm: 0.00
...
```

So `Vcore` should be queried as `in1`, and `+12V` should be queried as `in4`. According to [specification](#), these are voltages on chip pins and generally speaking may need scaling.

```
$ zabbix_get -s 127.0.0.1 -k sensor[lm85-i2c-0-2e,in1]
1.301000
```

Not only voltage (in), but also current (curr), temperature (temp) and fan speed (fan) readings can be retrieved by Zabbix.

7 Notes on memtype parameter in proc.mem items

Overview

The **memtype** parameter is supported on Linux, AIX, FreeBSD, and Solaris platforms.

Three common values of 'memtype' are supported on all of these platforms: `pmem`, `rss` and `vsize`. Additionally, platform-specific 'memtype' values are supported on some platforms.

AIX

See values supported for 'memtype' parameter on AIX in the table.

Supported value	Description	Source in proctentry64 structure	Tries to be compatible with
<code>vsize</code> ¹	Virtual memory size	<code>pi_size</code>	
<code>pmem</code>	Percentage of real memory	<code>pi_prm</code>	<code>ps -o pmem</code>
<code>rss</code>	Resident set size	<code>pi_trss + pi_drss</code>	<code>ps -o rssize</code>
<code>size</code>	Size of process (code + data)	<code>pi_dvm</code>	"ps gvw" SIZE column
<code>dsize</code>	Data size	<code>pi_dsize</code>	
<code>tsize</code>	Text (code) size	<code>pi_tsize</code>	"ps gvw" TSIZ column
<code>sdsiz</code>	Data size from shared library	<code>pi_sdsiz</code>	
<code>drss</code>	Data resident set size	<code>pi_drss</code>	
<code>trss</code>	Text resident set size	<code>pi_trss</code>	

Notes for AIX:

1. When choosing parameters for `proc.mem[]` item key on AIX, try to specify narrow process selection criteria. Otherwise there is a risk of getting unwanted processes counted into `proc.mem[]` result.

Example:

```
$ zabbix_agentd -t proc.mem[,,,NonExistingProcess,rss]
proc.mem[,,,NonExistingProcess,rss] [u|2879488]
```

This example shows how specifying only command line (regular expression to match) parameter results in Zabbix agent self-accounting - probably not what you want.

2. Do not use "ps -ef" to browse processes - it shows only non-kernel processes. Use "ps -Af" to see all processes which will be seen by Zabbix agent.
3. Let's go through example of 'topasrec' how Zabbix agent proc.mem[] selects processes.

```
$ ps -Af | grep topasrec
root 10747984      1  0   Mar 16      -   0:00 /usr/bin/topasrec -L -s 300 -R 1 -r 6 -o /var/perf daily
```

proc.mem[] has arguments:

```
proc.mem[<name>,<user>,<mode>,<cmdline>,<memtype>]
```

The 1st criterion is a process name (argument <name>). In our example Zabbix agent will see it as 'topasrec'. In order to match, you need to either specify 'topasrec' or to leave it empty. The 2nd criterion is a user name (argument <user>). To match, you need to either specify 'root' or to leave it empty. The 3rd criterion used in process selection is an argument <cmdline>. Zabbix agent will see its value as '/usr/bin/topasrec -L -s 300 -R 1 -r 6 -o /var/perf/daily/ -ypersistent=1 -O type=bin -ystart_time=04:08:54,Mar16,2023'. To match, you need to either specify a regular expression which matches this string or to leave it empty.

Arguments <mode> and <memtype> are applied after using the three criteria mentioned above.

FreeBSD

See values supported for 'memtype' parameter on FreeBSD in the table.

Supported value	Description	Source in kinfo_proc structure	Tries to be compatible with
vsiz	Virtual memory size	kp_eproc.e_vm.vm_maxsize or ki_size	ps -o vsiz
pmem	Percentage of real memory	calculated from rss	ps -o pmem
rss	Resident set size	kp_eproc.e_vm.vm_rssize or ki_rssize	ps -o rss
size ¹	Size of process (code + data + stack)	tsize + dsiz + ssize	ps -o tsize
tsiz	Text (code) size	kp_eproc.e_vm.vm_tsize or ki_tsize	ps -o tsiz
dsiz	Data size	kp_eproc.e_vm.vm_dsiz or ki_dsiz	ps -o dsiz
ssiz	Stack size	kp_eproc.e_vm.vm_ssiz or ki_ssiz	ps -o ssiz

Linux

See values supported for 'memtype' parameter on Linux in the table.

Supported value	Description	Source in /proc/<pid>/status file
vsiz ¹	Virtual memory size	VmSize
pmem	Percentage of real memory	(VmRSS/total_memory) * 100
rss	Resident set size	VmRSS
data	Size of data segment	VmData
exe	Size of code segment	VmExe
hwm	Peak resident set size	VmHWM
lck	Size of locked memory	VmLck
lib	Size of shared libraries	VmLib
peak	Peak virtual memory size	VmPeak
pin	Size of pinned pages	VmPin
pte	Size of page table entries	VmPTE
size	Size of process code + data + stack segments	VmExe + VmData + VmStk
stk	Size of stack segment	VmStk
swap	Size of swap space used	VmSwap

Notes for Linux:

Linux kernel threads

Threads cannot be selected with `cmdline` parameter in `proc.get[]`, `proc.mem[]` and `proc.num[]` items

Let's take as an example one of kernel threads:

```
$ ps -ef | grep kthreadd
root      2      0 0 09:33 ?          00:00:00 [kthreadd]
```

It can be selected with process name parameter:

```
$ zabbix_get -s localhost -k 'proc.num[kthreadd,root]'
1
```

But selection by process `cmdline` parameter does not work:

```
$ zabbix_get -s localhost -k 'proc.num[,root,,kthreadd]'
0
```

The reason is that Zabbix agent takes the regular expression specified in `cmdline` parameter and applies it to contents of process `/proc/<pid>/cmdline`. For kernel threads their `/proc/<pid>/cmdline` files are empty. So, `cmdline` parameter never matches.

Counting of threads in `proc.mem[]` and `proc.num[]` items

Linux kernel threads are counted by `proc.num[]` item but do not report memory in `proc.mem[]` item. For example:

```
$ ps -ef | grep kthreadd
root      2      0 0 09:51 ?          00:00:00 [kthreadd]
```

```
$ zabbix_get -s localhost -k 'proc.num[kthreadd]'
1
```

```
$ zabbix_get -s localhost -k 'proc.mem[kthreadd]'
ZBX_NOTSUPPORTED: Cannot get amount of "VmSize" memory.
```

But what happens if there is a user process with the same name as a kernel thread? Then it could look like this:

```
$ ps -ef | grep kthreadd
root      2      0 0 09:51 ?          00:00:00 [kthreadd]
zabbix    9611  6133  0 17:58 pts/1    00:00:00 ./kthreadd
```

```
$ zabbix_get -s localhost -k 'proc.num[kthreadd]'
2
```

```
$ zabbix_get -s localhost -k 'proc.mem[kthreadd]'
4157440
```

`proc.num[]` counted both the kernel thread and the user process. `proc.mem[]` reports memory for the user process only and counts the kernel thread memory as if it was 0. This is different from the case above when `ZBX_NOTSUPPORTED` was reported.

Be careful when using `proc.mem[]` and `proc.num[]` items if the program name happens to match one of the thread.

Before putting parameters into `proc.mem[]` and `proc.num[]` items, you may want to test the parameters using `proc.num[]` item and `ps` command.

9 Implementation details of `net.tcp.service` and `net.udp.service` checks

Implementation of `net.tcp.service` and `net.udp.service` checks is detailed on this page for various services specified in the service parameter.

Item `net.tcp.service` parameters

ftp

Creates a TCP connection and expects the first 4 characters of the response to be "220", then sends "QUIT\r\n". Default port 21 is used if not specified.

http

Creates a TCP connection without expecting and sending anything. Default port 80 is used if not specified.

https

Uses (and only works with) libcurl, does not verify the authenticity of the certificate, does not verify the host name in the SSL certificate, only fetches the response header (HEAD request). Default port 443 is used if not specified.

imap

Creates a TCP connection and expects the first 4 characters of the response to be `"* OK"`, then sends `"a1 LOGOUT\r\n"`. Default port 143 is used if not specified.

ldap

Opens a connection to an LDAP server and performs an LDAP search operation with filter set to `(objectClass=*)`. Expects successful retrieval of the first attribute of the first entry. Default port 389 is used if not specified.

nntp

Creates a TCP connection and expects the first 3 characters of the response to be `"200"` or `"201"`, then sends `"QUIT\r\n"`. Default port 119 is used if not specified.

pop

Creates a TCP connection and expects the first 3 characters of the response to be `"+OK"`, then sends `"QUIT\r\n"`. Default port 110 is used if not specified.

smtp

Creates a TCP connection and expects the first 3 characters of the response to be `"220"`, followed by a space, the line ending or a dash. The lines containing a dash belong to a multiline response and the response will be re-read until a line without the dash is received. Then sends `"QUIT\r\n"`. Default port 25 is used if not specified.

ssh

Creates a TCP connection. If the connection has been established, both sides exchange an identification string (SSH-major.minor-XXXX), where major and minor are protocol versions and XXXX is a string. Zabbix checks if the string matching the specification is found and then sends back the string `"SSH-major.minor-zabbix_agent\r\n"` or `"0\r\n"` on mismatch. Default port 22 is used if not specified.

tcp

Creates a TCP connection without expecting and sending anything. Unlike the other checks requires the port parameter to be specified.

telnet

Creates a TCP connection and expects a login prompt (': ' at the end). Default port 23 is used if not specified.

Item net.udp.service parameters

ntp

Sends an SNTP packet over UDP and validates the response according to [RFC 4330, section 5](#). Default port 123 is used if not specified.

10 proc.get parameters

Overview

The item **proc.get**[<name>,<user>,<cmdline>,<mode>] is supported on Linux, Windows, FreeBSD, OpenBSD, and NetBSD.

List of process parameters returned by the item varies depending on the operating system and 'mode' argument value.

Linux

The following process parameters are returned on Linux for each mode:

mode=process	mode=thread	mode=summary
pid: PID	pid: PID	name: process name
ppid: parent PID	ppid: parent PID	processes: number of processes
name: process name	name: process name	vsize: virtual memory size
cmdline: command with arguments	user: user (real) the process runs under	pmem: percentage of real memory
user: user (real) the process runs under	group: group (real) the process runs under	rss: resident set size

mode=process	mode=thread	mode=summary
group: group (real) the process runs under	uid: user ID	data: size of data segment
uid: user ID	gid: ID of the group the process runs under	exe: size of code segment
gid: ID of the group the process runs under	tid: thread ID	lib: size of shared libraries
vsize: virtual memory size	tname: thread name	lck: size of locked memory
pmem: percentage of real memory	cputime_user: total CPU seconds (user)	pin: size of pinned pages
rss: resident set size	cputime_system: total CPU seconds (system)	pte: size of page table entries
data: size of data segment	state: thread state	size: size of process code + data + stack segments
exe: size of code segment	ctx_switches: number of context switches	stk: size of stack segment
hwm: peak resident set size	page_faults: number of page faults	swap: size of swap space used
lck: size of locked memory		cputime_user: total CPU seconds (user)
lib: size of shared libraries		cputime_system: total CPU seconds (system)
peak: peak virtual memory size		ctx_switches: number of context switches
pin: size of pinned pages		threads: number of threads
pte: size of page table entries		page_faults: number of page faults
size: size of process code + data + stack segments		pss: proportional set size memory
stk: size of stack segment		
swap: size of swap space used		
cputime_user: total CPU seconds (user)		
cputime_system: total CPU seconds (system)		
state: process state (transparently retrieved from procfs, long form)		
ctx_switches: number of context switches		
threads: number of threads		
page_faults: number of page faults		
pss: proportional set size memory		

BSD-based OS

The following process parameters are returned on FreeBSD, OpenBSD, and NetBSD for each mode:

mode=process	mode=thread	mode=summary
pid: PID	pid: PID	name: process name
ppid: parent PID	ppid: parent PID	processes: number of processes
jid: ID of jail (FreeBSD only)	jid: ID of jail (FreeBSD only)	vsize: virtual memory size
jname: name of jail (FreeBSD only)	jname: name of jail (FreeBSD only)	pmem: percentage of real memory (FreeBSD only)
name: process name	name: process name	rss: resident set size
cmdline: command with arguments	user: user (real) the process runs under	size: size of process (code + data + stack)
user: user (real) the process runs under	group: group (real) the process runs under	tsize: text (code) size
group: group (real) the process runs under	uid: user ID	dsize: data size
uid: user ID	gid: ID of the group the process runs under	ssize: stack size

mode=process	mode=thread	mode=summary
gid: ID of the group the process runs under	tid: thread ID	cputime_user: total CPU seconds (user)
vsize: virtual memory size	tname: thread name	cputime_system: total CPU seconds (system)
pmem: percentage of real memory (FreeBSD only)	cputime_user: total CPU seconds (user)	ctx_switches: number of context switches
rss: resident set size	cputime_system: total CPU seconds (system)	threads: number of threads (not supported for NetBSD)
size: size of process (code + data + stack)	state: thread state	stk: size of stack segment
tsize: text (code) size	ctx_switches: number of context switches	page_faults: number of page faults
dsize: data size	io_read_op: number of times the system had to perform input	fds: number of file descriptors (OpenBSD only)
ssize: stack size	io_write_op: number of times the system had to perform output	swap: size of swap space used
cputime_user: total CPU seconds (user)		io_read_op: number of times the system had to perform input
cputime_system: total CPU seconds (system)		io_write_op: number of times the system had to perform output
state: process state (disk sleep/running/sleeping/tracing stop/zombie/other)		
ctx_switches: number of context switches		
threads: number of threads (not supported for NetBSD)		
page_faults: number of page faults		
fds: number of file descriptors (OpenBSD only)		
swap: size of swap space used		
io_read_op: number of times the system had to perform input		
io_write_op: number of times the system had to perform output		

Windows

The following process parameters are returned on Windows for each mode:

mode=process	mode=thread	mode=summary
pid: PID	pid: PID	name: process name
ppid: parent PID	ppid: parent PID	processes: number of processes
name: process name	name: process name	vmsize: virtual memory size
user: user the process runs under	user: user the process runs under	wkset: size of process working set
sid: user SID	sid: user SID	cputime_user: total CPU seconds (user)
vmsize: virtual memory size	tid: thread ID	cputime_system: total CPU seconds (system)
wkset: size of process working set		threads: number of threads
cputime_user: total CPU seconds (user)		page_faults: number of page faults
cputime_system: total CPU seconds (system)		handles: number of handles
threads: number of threads		io_read_b: IO bytes read
page_faults: number of page faults		io_write_b: IO bytes written
handles: number of handles		io_read_op: IO read operations
io_read_b: IO bytes read		io_write_op: IO write operations
io_write_b: IO bytes written		io_other_b: IO bytes transferred, other than read and write operations

mode=process	mode=thread	mode=summary
io_read_op: IO read operations		io_other_op: IO operations, other than read and write operations
io_write_op: IO write operations		
io_other_b: IO bytes transferred, other than read and write operations		
io_other_op: IO operations, other than read and write operations		

11 Unreachable/unavailable host interface settings

Overview

Several configuration **parameters** define how Zabbix server should behave when an agent check (Zabbix, SNMP, IPMI, JMX) fails and a host interface becomes unreachable.

Unreachable interface

A host interface is treated as unreachable after a failed check (network error, timeout) by Zabbix, SNMP, IPMI or JMX agents. Note that Zabbix agent active checks do not influence interface availability in any way.

From that moment **UnreachableDelay** defines how often an interface is rechecked using one of the items (including LLD rules) in this unreachability situation and such rechecks will be performed already by unreachable pollers (or IPMI pollers for IPMI checks). By default it is 15 seconds before the next check.

Attention:

Checks performed by asynchronous pollers are not moved to unreachable pollers.

In the Zabbix server log unreachability is indicated by messages like these:

```
Zabbix agent item "system.cpu.load[percpu,avg1]" on host "New host" failed: first network error, wait for
Zabbix agent item "system.cpu.load[percpu,avg15]" on host "New host" failed: another network error, wait f
```

Note that the exact item that failed is indicated and the item type (Zabbix agent).

Note:

The *Timeout* parameter will also affect how early an interface is rechecked during unreachability. If the Timeout is 20 seconds and UnreachableDelay 30 seconds, the next check will be in 50 seconds after the first attempt.

The **UnreachablePeriod** parameter defines how long the unreachability period is in total. By default UnreachablePeriod is 45 seconds. UnreachablePeriod should be several times bigger than UnreachableDelay, so that an interface is rechecked more than once before an interface becomes unavailable.

Switching interface back to available

When the unreachability period is over, the interface is polled again, decreasing priority for item that turned the interface into unreachable state. If the unreachable interface reappears, the monitoring returns to normal automatically:

```
resuming Zabbix agent checks on host "New host": connection restored
```

Note:

Once interface becomes available, the host does not poll all its items immediately for two reasons:

- It might overload the host.
- The interface restore time is not always matching planned item polling schedule time.

So, after the interface becomes available, items are not polled immediately, but they are getting rescheduled to their next polling round.

Unavailable interface

After the UnreachablePeriod ends and the interface has not reappeared, the interface is treated as unavailable.

In the server log it is indicated by messages like these:

```
temporarily disabling Zabbix agent checks on host "New host": interface unavailable
```

and in the **frontend** the host availability icon goes from green/gray to yellow/red (the unreachable interface details can be seen in the hint box that is displayed when a mouse is positioned on the host availability icon):

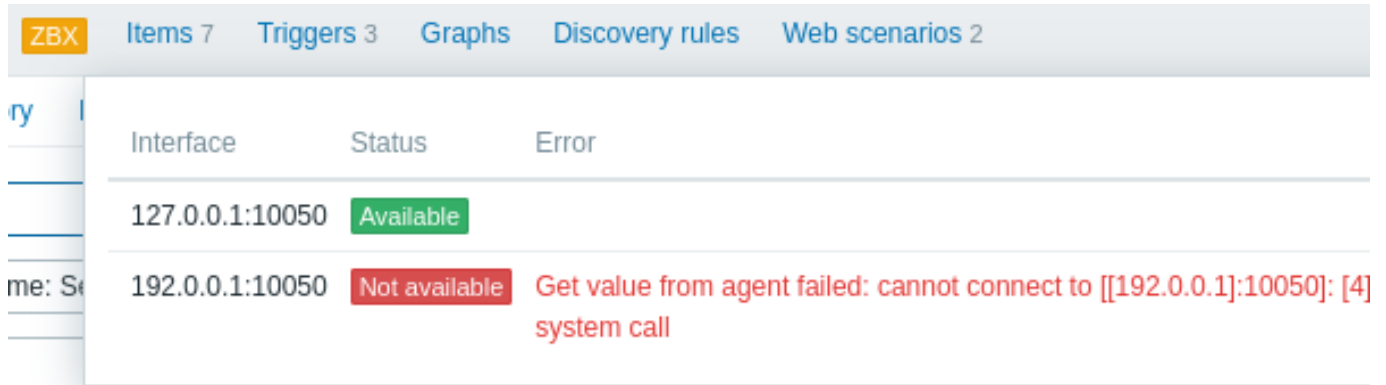

The screenshot shows the Zabbix web interface with a navigation bar at the top containing 'ZBX', 'Items 7', 'Triggers 3', 'Graphs', 'Discovery rules', and 'Web scenarios 2'. Below the navigation bar is a table with the following columns: 'Interface', 'Status', and 'Error'. The table contains two rows of data:

Interface	Status	Error
127.0.0.1:10050	Available	
192.0.0.1:10050	Not available	Get value from agent failed: cannot connect to [[192.0.0.1]:10050]: [4] system call

The **UnavailableDelay** parameter defines how often an interface is checked during interface unavailability.

By default it is 60 seconds (so in this case "temporarily disabling", from the log message above, will mean disabling checks for one minute).

When the connection to the interface is restored, the monitoring returns to normal automatically, too:

enabling Zabbix agent checks on host "New host": interface became available

12 Remote monitoring of Zabbix stats

Overview

It is possible to make some internal metrics of Zabbix server and proxy accessible remotely by another Zabbix instance or a third-party tool. This can be useful so that supporters/service providers can monitor their client Zabbix servers/proxies remotely or, in organizations where Zabbix is not the main monitoring tool, that Zabbix internal metrics can be monitored by a third-party system in an umbrella-monitoring setup.

Zabbix internal stats are exposed to a configurable set of addresses listed in the new 'StatsAllowedIP' **server/proxy** parameter. Requests will be accepted only from these addresses.

Items

To configure querying of internal stats on another Zabbix instance, you may use two items:

- `zabbix[stats,<ip>,<port>]` internal item - for direct remote queries of Zabbix server/proxy. `<ip>` and `<port>` are used to identify the target instance.
- `zabbix.stats[<ip>,<port>]` agent item - for agent-based remote queries of Zabbix server/proxy. `<ip>` and `<port>` are used to identify the target instance.

See also: [Internal items](#), [Zabbix agent items](#)

The following diagram illustrates the use of either item depending on the context.

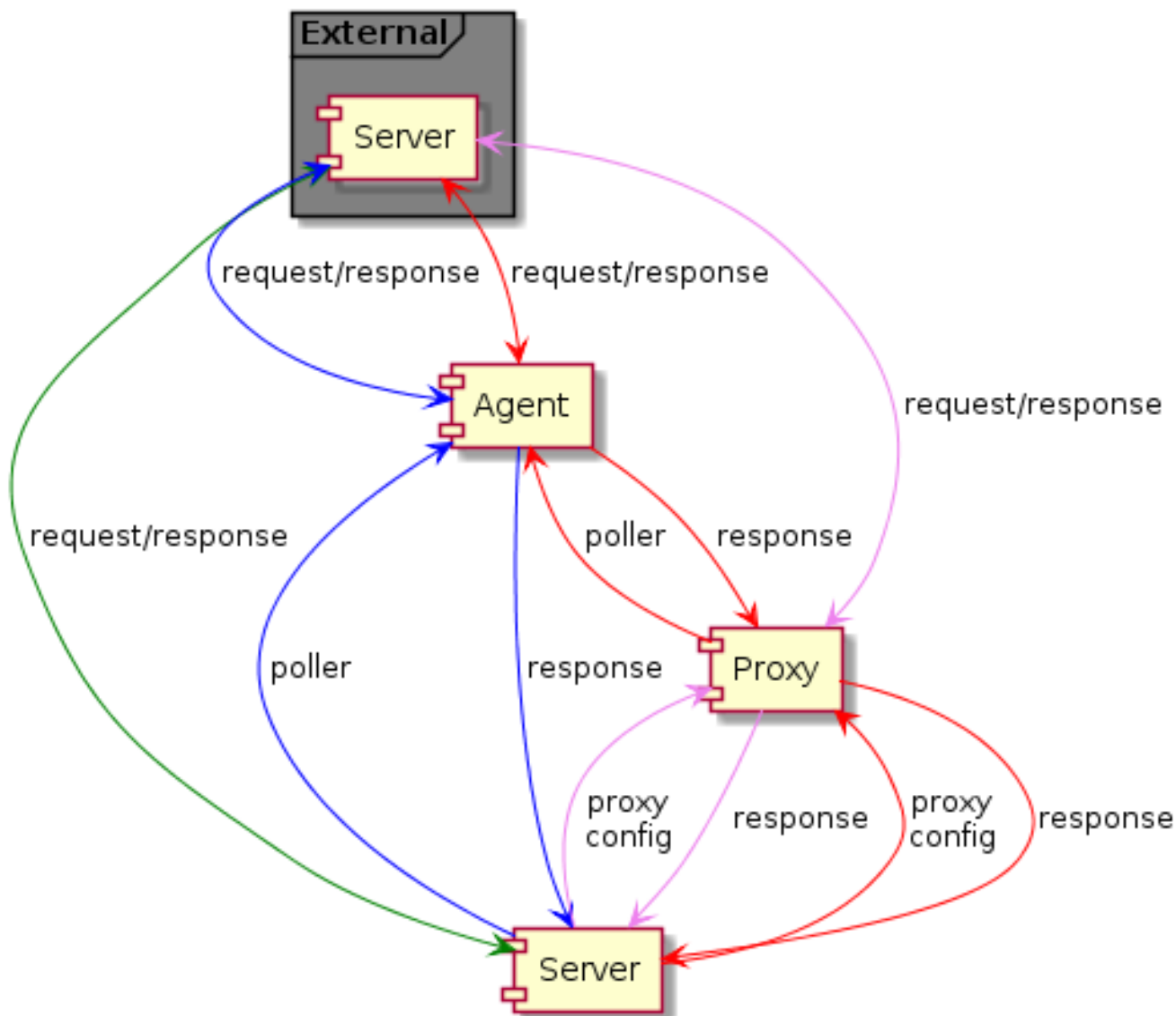

- ■ - Server → external Zabbix instance (`zabbix[stats,<ip>,<port>]`)
- ■ - Server → proxy → external Zabbix instance (`zabbix[stats,<ip>,<port>]`)
- ■ - Server → agent → external Zabbix instance (`zabbix.stats[<ip>,<port>]`)
- ■ - Server → proxy → agent → external Zabbix instance (`zabbix.stats[<ip>,<port>]`)

To make sure that the target instance allows querying it by the external instance, list the address of the external instance in the 'StatsAllowedIP' parameter on the target instance.

Exposed metrics

The stats items gather the statistics in bulk and return a JSON, which is the basis for dependent items to get their data from. The following **internal metrics** are returned by either of the two items:

- `zabbix[boottime]`
- `zabbix[hosts]`
- `zabbix[items]`
- `zabbix[items_unsupported]`
- `zabbix[preprocessing_queue]` (server only)
- `zabbix[process,<type>,<mode>,<state>]` (only process type based statistics)
- `zabbix[rcache,<cache>,<mode>]`
- `zabbix[requiredperformance]`
- `zabbix[triggers]` (server only)
- `zabbix[uptime]`
- `zabbix[vcache,buffer,<mode>]` (server only)
- `zabbix[vcache,cache,<parameter>]`

- zabbix[version]
- zabbix[vmware,buffer,<mode>]
- zabbix[wcache,<cache>,<mode>] ('trends' cache type server only)

Templates

Templates are available for remote monitoring of Zabbix server or proxy internal metrics from an external instance:

- Remote Zabbix server health
- Remote Zabbix proxy health

Note that in order to use a template for remote monitoring of multiple external instances, a separate host is required for each external instance monitoring.

Trapper process

Receiving internal metric requests from an external Zabbix instance is handled by the trapper process that validates the request, gathers the metrics, creates the JSON data buffer and sends the prepared JSON back, for example, from server:

```
{
  "response": "success",
  "data": {
    "boottime": N,
    "uptime": N,
    "hosts": N,
    "items": N,
    "items_unsupported": N,
    "preprocessing_queue": N,
    "process": {
      "alert manager": {
        "busy": {
          "avg": N,
          "max": N,
          "min": N
        },
        "idle": {
          "avg": N,
          "max": N,
          "min": N
        },
        "count": N
      },
      ...
    },
    "queue": N,
    "rcache": {
      "total": N,
      "free": N,
      "pfree": N,
      "used": N,
      "pused": N
    },
    "requiredperformance": N,
    "triggers": N,
    "uptime": N,
    "vcache": {
      "buffer": {
        "total": N,
        "free": N,
        "pfree": N,
        "used": N,
        "pused": N
      },
      "cache": {
        "requests": N,
        "hits": N,

```

```

    "misses": N,
    "mode": N
  }
},
"vmware": {
  "total": N,
  "free": N,
  "pfree": N,
  "used": N,
  "pused": N
},
"version": "N",
"wcache": {
  "values": {
    "all": N,
    "float": N,
    "uint": N,
    "str": N,
    "log": N,
    "text": N,
    "not supported": N
  },
  "history": {
    "pfree": N,
    "free": N,
    "total": N,
    "used": N,
    "pused": N
  },
  "index": {
    "pfree": N,
    "free": N,
    "total": N,
    "used": N,
    "pused": N
  },
  "trend": {
    "pfree": N,
    "free": N,
    "total": N,
    "used": N,
    "pused": N
  }
}
}
}
}

```

Internal queue items

There are also another two items specifically allowing to remote query internal queue stats on another Zabbix instance:

- `zabbix[stats,<ip>,<port>,queue,<from>,<to>]` internal item - for direct internal queue queries to remote Zabbix server/proxy
- `zabbix.stats[<ip>,<port>,queue,<from>,<to>]` agent item - for agent-based internal queue queries to remote Zabbix server/proxy

See also: [Internal items](#), [Zabbix agent items](#)

13 Configuring Kerberos with Zabbix

Overview

Kerberos authentication can be used in web monitoring and HTTP items in Zabbix.

This section describes an example of configuring Kerberos with Zabbix server to perform web monitoring of `www.example.com` with user `'zabbix'`.

Steps

Step 1

Install Kerberos package.

For Debian/Ubuntu:

```
apt install krb5-user
```

For RHEL:

```
dnf install krb5-workstation
```

Step 2

Configure Kerberos configuration file (see MIT documentation for details)

```
cat /etc/krb5.conf
[libdefaults]
    default_realm = EXAMPLE.COM

#### The following krb5.conf variables are only for MIT Kerberos.
    kdc_timesync = 1
    ccache_type = 4
    forwardable = true
    proxiable = true

[realms]
    EXAMPLE.COM = {
    }

[domain_realm]
    .example.com=EXAMPLE.COM
    example.com=EXAMPLE.COM
```

Step 3

Create a Kerberos ticket for user `zabbix`. Run the following command as user `zabbix`:

```
kinit zabbix
```

Attention:

It is important to run the above command as user `zabbix`. If you run it as `root` the authentication will not work.

Step 4

Create a web scenario or HTTP agent item with Kerberos authentication type.

Optionally can be tested with the following curl command:

```
curl -v --negotiate -u : http://example.com
```

Note that for lengthy web monitoring it is necessary to take care of renewing the Kerberos ticket. Default time of ticket expiration is 10h.

14 modbus.get parameters

Overview

The table below presents details of the `modbus.get` `item` parameters.

Parameters

Parameter	Description	Defaults	Example
<i>endpoint</i>	<p>Protocol and address of the endpoint, defined as <code>protocol://connection_string</code></p> <p>Possible protocol values: <i>rtu</i>, <i>ascii</i> (Agent 2 only), <i>tcp</i></p> <p>Connection string format:</p> <p>with <i>tcp</i> - <code>address:port</code> with serial line: <i>rtu</i>, <i>ascii</i> - <code>port_name:speed:params</code> where 'speed' - 1200, 9600 etc 'params' - data bits (5,6,7 or 8), parity (n,e or o for none/even/odd), stop bits (1 or 2)</p>	<p>protocol: none</p> <p><i>rtu/ascii</i> protocol: port_name: none speed: 115200 params: 8n1</p> <p><i>tcp</i> protocol: address: none port: 502</p>	<p><code>tcp://192.168.6.1:511</code> <code>tcp://192.168.6.2</code> <code>tcp://[::1]:511</code> <code>tcp://:1</code> <code>tcp://localhost:511</code> <code>tcp://localhost</code> <code>rtu://COM1:9600:8n</code> <code>ascii://COM2:1200:7o2</code> <code>rtu://ttyS0:9600</code> <code>ascii://ttyS1</code></p>
<i>slave id</i>	<p>Modbus address of the device it is intended for (1 to 247), see MODBUS Messaging Implementation Guide (page 23)</p>	<p>serial: 1</p> <p>tcp: 255 (0xFF)</p>	2
<i>function</i>	<p>tcp device (not GW) will ignore the field</p> <p>Empty or value of a supported function:</p> <p>1 - Read Coil, 2 - Read Discrete Input, 3 - Read Holding Registers, 4 - Read Input Registers</p>	empty	3
<i>address</i>	<p>Address of the first registry, coil or input.</p> <p>If 'function' is empty, then 'address' should be in range for: Coil - 00001 - 09999 Discrete input - 10001 - 19999 Input register - 30001 - 39999 Holding register - 40001 - 49999</p> <p>If 'function' is not empty, the 'address' field will be from 0 till 65535 and used without modification (PDU)</p>	<p>empty function: 00001</p> <p>non-empty function: 0</p>	9999
<i>count</i>	<p>Count of sequenced 'type' which will be read from device, where:</p> <p>for Coil or Discrete input the 'type' = 1 bit for other cases: $(count * sizeof(type)) / 2 = \text{real count of registers for reading}$ If 'offset' is not 0, the value will be added to 'real count'</p> <p>Acceptable range for 'real count' is 1:65535</p>	1	2
<i>type</i>	<p>Data type:</p> <p>for Read Coil and Read Discrete Input - <i>bit</i></p> <p>for Read Holding Registers and Read Input Registers: <i>int8</i> - 8bit <i>uint8</i> - 8bit (unsigned) <i>int16</i> - 16bit <i>uint16</i> - 16bit (unsigned) <i>int32</i> - 32bit <i>uint32</i> - 32bit (unsigned) <i>float</i> - 32bit <i>uint64</i> - 64bit (unsigned) <i>double</i> - 64bit</p>	<p>bit</p> <p>uint16</p>	uint64

Parameter	Description	Defaults	Example
<i>endianness</i>	Endianness type: <i>be</i> - Big Endian <i>le</i> - Little Endian <i>mbe</i> - Mid-Big Endian <i>mle</i> - Mid-Little Endian Limitations: for 1 bit - <i>be</i> for 8 bits - <i>be,le</i> for 16 bits - <i>be,le</i>	<i>be</i>	<i>le</i>
<i>offset</i>	Number of registers, starting from 'address', the result of which will be discarded. The size of each register is 16bit (needed to support equipment that does not support random read access).	0	4

15 Creating custom performance counter names for VMware

Overview

The VMware performance counter path has the `group/counter[rollup]` format where:

- `group` - the performance counter group, for example *cpu*
- `counter` - the performance counter name, for example *usagemhz*
- `rollup` - the performance counter rollup type, for example *average*

So the above example would give the following counter path: `cpu/usagemhz[average]`

The performance counter group descriptions, counter names and rollup types can be found in [VMware documentation](#).

It is possible to obtain internal names and create custom performance counter names by using script item in Zabbix.

Configuration

1. Create disabled Script item on the main VMware host (where the **eventlog[]** item is present) with the following parameters:

Item Tags Preprocessing

* Name

Type

* Key

Type of information

Name	Value	Action
<input type="text"/>	<input type="text"/>	<input type="button" value="Remove"/>

* Script

* Update interval

Type	Interval	Period	Action
<input type="text" value="Flexible"/> <input type="text" value="Scheduling"/>	<input type="text" value="50s"/>	<input type="text" value="1-7,00:00-24:00"/>	<input type="button" value="Remove"/>

* Timeout

* History

Populates host inventory field

Description

Enabled

- Name: VMware metrics
- Type: Script
- Key: vmware.metrics
- Type of information: Text
- Script: copy and paste the **script** provided below
- Timeout: 10
- History: Do not store
- Enabled: unmarked

Script

```
try {
  Zabbix.log(4, 'vmware metrics script');

  var result, resp,
  req = new HttpRequest();
  req.addHeader('Content-Type: application/xml');
  req.addHeader('SOAPAction: "urn:vim25/6.0"');

  login = '<soapenv:Envelope xmlns:soapenv="http://schemas.xmlsoap.org/soap/envelope/" xmlns:urn="urn:vim25/6.0">
<soapenv:Header/>
<soapenv:Body>
  <urn:Login>
    <urn:_this type="SessionManager">SessionManager</urn:_this>
    <urn:userName>{$VMWARE.USERNAME}</urn:userName>
    <urn:password>{$VMWARE.PASSWORD}</urn:password>
  </urn:Login>
</soapenv:Body>
</soapenv:Envelope>'
  resp = req.post("{$VMWARE.URL}", login);
  if (req.getStatus() != 200) {
```

```

        throw 'Response code: '+req.getStatus();
    }

    query = '<soapenv:Envelope xmlns:soapenv="http://schemas.xmlsoap.org/soap/envelope/" xmlns:urn="urn:vi
<soapenv:Header/>\
<soapenv:Body>\
    <urn:RetrieveProperties>\
        <urn:_this type="PropertyCollector">propertyCollector</urn:_this>\
        <urn:specSet>\
            <urn:propSet>\
                <urn:type>PerformanceManager</urn:type>\
                <urn:pathSet>perfCounter</urn:pathSet>\
            </urn:propSet>\
            <urn:objectSet>\
                <urn:obj type="PerformanceManager">PerfMgr</urn:obj>\
            </urn:objectSet>\
        </urn:specSet>\
    </urn:RetrieveProperties>\
</soapenv:Body>\
</soapenv:Envelope>'
    resp = req.post("${VMWARE.URL}", query);
    if (req.getStatus() != 200) {
        throw 'Response code: '+req.getStatus();
    }
    Zabbix.log(4, 'vmware metrics=' + resp);
    result = resp;

    logout = '<soapenv:Envelope xmlns:soapenv="http://schemas.xmlsoap.org/soap/envelope/" xmlns:urn="urn:v
<soapenv:Header/>\
<soapenv:Body>\
    <urn:Logout>\
        <urn:_this type="SessionManager">SessionManager</urn:_this>\
    </urn:Logout>\
</soapenv:Body>\
</soapenv:Envelope>'

    resp = req.post("${VMWARE.URL}",logout);
    if (req.getStatus() != 200) {
        throw 'Response code: '+req.getStatus();
    }
} catch (error) {
    Zabbix.log(4, 'vmware call failed : '+error);
    result = {};
}

```

return result;

Once the item is configured, press *Test* button, then press *Get value*.

Test item

? X

Get value from host

Host address

Port

Proxy

Get value

Copy received XML to any XML formatter and find the desired metric.

An example of XML for one metric:

```

<PerfCounterInfo xsi:type="PerfCounterInfo">
    <key>6</key>

```

```

<nameInfo>
  <label>Usage in MHz</label>
  <summary>CPU usage in megahertz during the interval</summary>
  <key>usagemhz</key>
</nameInfo>
<groupInfo>
  <label>CPU</label>
  <summary>CPU</summary>
  <key>cpu</key>
</groupInfo>
<unitInfo>
  <label>MHz</label>
  <summary>Megahertz</summary>
  <key>megaHertz</key>
</unitInfo>
<rollupType>average</rollupType>
<statsType>rate</statsType>
<level>1</level>
<perDeviceLevel>3</perDeviceLevel>
</PerfCounterInfo>

```

Use XPath to extract the counter path from received XML. For the example above, the XPath will be:

field	xPath	value
group	//groupInfo[../key=6]/key	cpu
counter	//nameInfo[../key=6]/key	usagemhz
rollup	//rollupType[../key=6]	average

Resulting performance counter path in this case is: `cpu/usagemhz[average]`

16 Return values for `system.sw.packages.get`

Overview

This section provides return value details for the `system.sw.packages.get` Zabbix agent item.

Details

The output of this item is an array of objects each containing the following keys:

- **name** - package name
- **manager** - package manager that reported this data (rpm, dpkg, pacman, pkgtool, or portage)
- **version** - package version
- **size** - uncompressed package size in bytes (if not available, set to 0)
- **arch** - package architecture
- **buildtime** - an object with 2 entries:
 - **timestamp** - UNIX timestamp when the package was built (if not available, set to 0)
 - **value** - human readable date and time when the package was built (if not available, set to empty string)
- **installtime** - an object with 2 entries:
 - **timestamp** - UNIX timestamp when the package was installed (if not available, set to 0)
 - **value** - human readable date and time when the package was installed (if not available, set to empty string)

Example:

```

[
  {
    "name": "util-linux-core",
    "manager": "rpm",
    "version": "2.37.4-3.e19",
    "size": 1296335,
    "arch": "x86_64",
    "buildtime": {
      "timestamp" : 1653552239,
      "value" : "Sep 20 01:39:40 2021 UTC"
    }
  }
]

```



```

    },
    "installtime": {
      "timestamp" : 1660780885,
      "value" : "Aug 18 00:01:25 2022 UTC"
    }
  },
  {
    "name": "xfonts-base",
    "manager": "dpkg",
    "version": "1:1.0.5",
    "size": 7337984,
    "arch": "all",
    "buildtime": {
      "timestamp": 0,
      "value": ""
    },
    "installtime": {
      "timestamp": 0,
      "value": ""
    }
  }
]

```

17 Return values for net.dns.get

Overview

This section provides return value details for the `net.dns.get` Zabbix agent 2 item.

Details

The output of this item is an object containing DNS record information based on the parameters provided in the item key.

For example, the `net.dns.get[,example.com]` item may return the following JSON of a refused query:

```

{
  "flags": [
    "RA"
  ],
  "query_time": "0.00",
  "question_section": [
    {
      "qclass": "IN",
      "qname": "example.com.",
      "qtype": "SOA"
    }
  ],
  "response_code": "REFUSED",
  "zbx_error_code": 0
}

```

By specifying the IP address of the DNS server, the `net.dns.get[192.0.2.0,example.com]` item may return the following JSON:

```

{
  "answer_section": [
    {
      "class": "IN",
      "name": "example.com.",
      "rdata": {
        "expire": 1209600,
        "mbox": "noc.dns.example.org.",
        "minttl": 3600,
        "ns": "ns.example.org.",
        "refresh": 7200,

```

```

        "retry": 3600,
        "serial": 2022091378
    },
    "rdlength": 44,
    "ttl": 1205,
    "type": "SOA"
}
],
"flags": [
    "RA"
],
"query_time": "0.02",
"question_section": [
    {
        "qclass": "IN",
        "qname": "example.com.",
        "qtype": "SOA"
    }
],
"response_code": "NOERROR",
"zbx_error_code": 0
}

```

If there is a connection problem, the `net.dns.get[192.0.2.0,example.com]` item may return an error:

```

{
    "zbx_error_code": -1,
    "zbx_error_msg": "Communication error: read udp 192.0.2.0:12345->192.0.2.0:53: i/o timeout"
}

```

The following types of error codes are possible:

Scenario	"zbx_error_code"	"zbx_error_msg"
No errors and the DNS response was received and parsed.	0	
DNS is down.	-1	"Communication error"
Error occurs during JSON parsing	-2	"Received unexpected response"

With additional parameters, the `net.dns.get[192.0.2.0,example.com,ANY,5,5,tcp,"cdfldflag,rdflag,dnssec,nsid,edns0,aaflag"]` item may return the following JSON:

```

{
    "additional_section": [
        {
            "extended_rcode": 32768,
            "name": ".",
            "rdata": {
                "options": [
                    {
                        "code": 0,
                        "nsid": "67 70 64 6e 73 2d 6c 70 70"
                    }
                ]
            },
            "rdlength": 13,
            "type": "OPT",
            "udp_payload": 512
        }
    ],
    "answer_section": [
        {
            "class": "IN",
            "name": "example.com.",
            "rdata": {

```

```

        "a": "192.0.2.0"
    },
    "rdlength": 4,
    "ttl": 19308,
    "type": "A"
},
{
    "class": "IN",
    "name": "example.com.",
    "rdata": {
        "algorithm": 13,
        "expiration": 1704715951,
        "inception": 1702910624,
        "key_tag": 21021,
        "labels": 2,
        "orig_ttl": 86400,
        "signature": "HVB0BcJJQyOS08J3f8kviPj8UkEUj7wmyiMyQqPSWgQIY9SCEJ5plq6KuxJmtAek1txZWXDo+6tp",
        "signer_name": "example.com.",
        "type_covered": "A"
    },
    "rdlength": 95,
    "ttl": 19308,
    "type": "RRSIG"
}
],
"flags": [
    "RD",
    "RA",
    "AD",
    "CD"
],
"query_time": "0.05",
"question_section": [
    {
        "qclass": "IN",
        "qname": "example.com.",
        "qtype": "ANY"
    }
],
"response_code": "NOERROR",
"zbx_error_code": 0
}

```

See also

For more information about DNS records, see:

- [Domain Names - Implementation and Specification](#)
- [Domain Name System \(DNS\) Parameters](#)

18 Notes on system.cpu.util items on Windows

`system.cpu.util` item provides the CPU utilization percentage.

64 logical CPUs (threads) is a hard limit for 32-bit Windows systems and some old 64-bit versions, such as Windows Vista. Systems with ≤ 64 threads will always have one processor group (see [known issues](#)), which means it's OK to use the old performance counter "`\Processor(n)% Processor Time`". However, for systems with more than 64 threads Windows distributes them evenly across multiple processor groups with maximum 64 threads per single group. Given that "`\Processor(n)`" doesn't report values for $n \geq 64$ we need to use "`\Processor Information(g, n)`" where g is a group number and n is a thread number within the group. So, for 72-thread system there will be two groups with 36 threads each and Windows will report counters "`\Processor Information(0, n)`" with $0 \leq n \leq 31$ and "`\Processor Information(1,n)`".

When a collector process is started on Zabbix agent for Windows, the following performance counters are initialized and later used for Zabbix agent items with key `system.cpu.util[n]`, `system.cpu.util[total]`.

If logical CPU count is less or equal than 64 and number of CPU groups is equal to 1, then the following counters are initialized, where G is processor group count and N is processor count in group:

```
\Processor(_Total)\% Processor Time
\Processor(0)\% Processor Time
\Processor(1)\% Processor Time
\Processor(2)\% Processor Time
...
\Processor(N-1)\% Processor Time
```

Else:

```
\Processor Information(_Total)\% Processor Time
\Processor Information(0,0)\% Processor Time
\Processor Information(0,1)\% Processor Time
\Processor Information(0,2)\% Processor Time
...
\Processor Information(0,N-1)\% Processor Time
...
\Processor Information(G-1,0)\% Processor Time
\Processor Information(G-1,1)\% Processor Time
\Processor Information(G-1,2)\% Processor Time
...
\Processor Information(G-1,N-1)\% Processor Time
```

5 Supported functions

Click on the respective function group to see more details.

Function group	Functions
Aggregate functions	avg, bucket_percentile, count, histogram_quantile, item_count, kurtosis, mad, max, min, skewness, stddevpop, stddevsamp, sum, sumofsquares, varpop, varsamp
Foreach functions	avg_foreach, bucket_rate_foreach, count_foreach, exists_foreach, last_foreach, max_foreach, min_foreach, sum_foreach
Bitwise functions	bitand, bitlshift, bitnot, bitor, bitrshift, bitxor
Date and time functions	date, dayofmonth, dayofweek, now, time
History functions	change, changecount, count, countunique, find, first, fuzzytime, last, logeventid, logseverity, logsource, monodec, monoinc, nodata, percentile, rate
Trend functions	baselinedev, baselinewma, trendavg, trendcount, trendmax, trendmin, trendstl, trendsum
Mathematical functions	abs, acos, asin, atan, atan2, avg, cbrt, ceil, cos, cosh, cot, degrees, e, exp, expm1, floor, log, log10, max, min, mod, pi, power, radians, rand, round, signum, sin, sinh, sqrt, sum, tan, truncate
Operator functions	between, in
Predictive functions	forecast, timeleft

Function group	Functions
String functions	ascii, bitlength, bytelength, char, concat, insert, jsonpath, left, length, ltrim, mid, repeat, replace, right, rtrim, trim, xpath

These functions are supported in [trigger expressions](#) and [calculated items](#).

Foreach functions are supported only for [aggregate calculations](#).

1 Aggregate functions

Except where stated otherwise, all functions listed here are supported in:

- [Trigger expressions](#)
- [Calculated items](#)

Aggregate functions can work with either:

- history of items, for example, `min(/host/key, 1h)`
- [foreach functions](#) as the only parameter, for example, `min(last_foreach(/*/key))` (only in calculated items; cannot be used in triggers)

The functions are listed without additional information. Click on the function to see the full details.

Function	Description
avg	The average value of an item within the defined evaluation period.
bucket_percentile	Calculates the percentile from the buckets of a histogram.
count	The count of values in an array returned by a foreach function.
histogram_quantile	Calculates the ϕ -quantile from the buckets of a histogram.
item_count	The count of existing items in configuration that match the filter criteria.
kurtosis	The "tailedness" of the probability distribution in collected values within the defined evaluation period.
mad	The median absolute deviation in collected values within the defined evaluation period.
max	The highest value of an item within the defined evaluation period.
min	The lowest value of an item within the defined evaluation period.
skewness	The asymmetry of the probability distribution in collected values within the defined evaluation period.
stddevpop	The population standard deviation in collected values within the defined evaluation period.
stddevsamp	The sample standard deviation in collected values within the defined evaluation period.
sum	The sum of collected values within the defined evaluation period.
sumofsquares	The sum of squares in collected values within the defined evaluation period.
varpop	The population variance of collected values within the defined evaluation period.
varsamp	The sample variance of collected values within the defined evaluation period.

Common parameters

- `/host/key` is a common mandatory first parameter for the functions referencing the host item history
- `(sec|#num)<:time shift>` is a common second parameter for the functions referencing the host item history, where:
 - **sec** - maximum [evaluation period](#) in seconds (time [suffixes](#) can be used), or
 - **#num** - maximum [evaluation range](#) in latest collected values (if preceded by a hash mark)
 - **time shift** (optional) allows to move the evaluation point back in time. See [more details](#) on specifying time shift.

Function details

Some general notes on function parameters:

- Function parameters are separated by a comma
- Optional function parameters (or parameter parts) are indicated by `< >`
- Function-specific parameters are described with each function
- `/host/key` and `(sec|#num)<:time shift>` parameters must never be quoted

`avg(/host/key,(sec|#num)<:time shift>)`

The average value of an item within the defined evaluation period.
 Supported value types: *Float*, *Integer*.
 Supported [foreach functions](#): *avg_foreach*, *count_foreach*, *exists_foreach*, *last_foreach*, *max_foreach*, *min_foreach*, *sum_foreach*.

Parameters: see [common parameters](#).

Time shift is useful when there is a need to compare the current average value with the average value some time ago.

Examples:

```
avg(/host/key,1h) #the average value for the last hour until now
avg(/host/key,1h:now-1d) #the average value for an hour from 25 hours ago to 24 hours ago from now
avg(/host/key,#5) #the average value of the five latest values
avg(/host/key,#5:now-1d) #the average value of the five latest values excluding the values received in the
```

```
bucket_percentile(item filter,time period,percentage)
```

Calculates the percentile from the buckets of a histogram.

Parameters:

- **item filter** - see [item filter](#);

- **time period** - see [time period](#);

- **percentage** - percentage (0-100).

Comments:

- Supported only in calculated items;
- This function is an alias for `histogram_quantile(percentage/100, bucket_rate_foreach(item filter, time period, 1))`.

```
count(func_foreach(item filter,<time period>),<operator>,<pattern>)
```

The count of values in an array returned by a foreach function.
 Supported [foreach functions](#): `avg_foreach`, `count_foreach`, `exists_foreach`, `last_foreach`, `max_foreach`, `min_foreach`, `sum_foreach`.

Parameters:

- **func_foreach** - foreach function for which the number of returned values should be counted (with supported arguments). See [foreach functions](#) for details.
- **item filter** - see [item filter](#);

- **time period** - see [time period](#);

- **operator** (must be double-quoted). Supported operators:
`eq` - equal
`ne` - not equal
`gt` - greater
`ge` - greater or equal
`lt` - less
`le` - less or equal
`like` - matches if contains pattern (case-sensitive)
`bitand` - bitwise AND
`regexp` - case-sensitive match of the regular expression given in `pattern`
`iregexp` - case-insensitive match of the regular expression given in `pattern`

- **pattern** - the required pattern (string arguments must be double-quoted); supported if `operator` is specified in the third parameter.

Comments:

- Using **count()** with a history-related foreach function (`max_foreach`, `avg_foreach`, etc.) may lead to performance implications, whereas using **exists_foreach()**, which works only with configuration data, will not have such effect.
- Optional parameters `operator` or `pattern` can't be left empty after a comma, only fully omitted.
- With `bitand` as the third parameter, the fourth `pattern` parameter can be specified as two numbers, separated by `/'`: **number_to_compare_with/mask**. `count()` calculates "bitwise AND" from the value and the `mask` and compares the result to `number_to_compare_with`. If the result of "bitwise AND" is equal to `number_to_compare_with`, the value is counted.
If `number_to_compare_with` and `mask` are equal, only the `mask` need be specified (without `/'`).
- With `regexp` or `iregexp` as the third parameter, the fourth `pattern` parameter can be an ordinary or **global** (starting with `'@'`) regular expression. In case of global regular expressions case sensitivity is inherited from global regular expression settings. For the purpose of `regexp` matching, float values will always be represented with 4 decimal digits after `.'`. Also note that for large numbers difference in decimal (stored in database) and binary (used by Zabbix server) representation may affect the 4th decimal digit.

Examples:

```
count(max_foreach(/*/net.if.in[*],1h)) #the number of net.if.in items that received data in the last hour
count(last_foreach(/*/vfs.fs.dependent.size[*],pushed),"gt",95) #the number of file systems with over 95% o
histogram_quantile(quantile,bucket1,value1,bucket2,value2,...)
```

Calculates the ϕ -quantile from the buckets of a histogram.
 Supported [foreach function](#): `bucket_rate_foreach`.

Parameters:

- **quantile** - $0 \leq \phi \leq 1$;

- **bucketN, valueN** - manually entered pairs (≥ 2) of parameters or the response of `bucket_rate_foreach`.

Comments:

- Supported only in calculated items;
- Functionally corresponds to 'histogram_quantile' of PromQL;
- Returns -1 if values of the last 'Infinity' bucket ("+"inf") are equal to 0.

Examples:

```
histogram_quantile(0.75,1.0,last(/host/rate_bucket[1.0]),"+Inf",last(/host/rate_bucket[Inf]))
histogram_quantile(0.5,bucket_rate_foreach(/item_key,30s))
```

```
item_count(item filter)
```

The count of existing items in configuration that match the filter criteria.
 Supported value type: *Integer*.

Parameter:

- **item filter** - criteria for item selection, allows referencing by host group, host, item key, and tags. Wildcards are supported. See [item filter](#) for more details.

Comments:

- Supported only in calculated items;
- Works as an alias for the `count(exists_foreach(item_filter))` function.

Examples:

```
item_count(/*/agent.ping?[group="Host group 1"]) #the number of hosts with the *agent.ping* item in the "E
kurtosis(/host/key,(sec|#num)<:time shift>)
```

The "tailedness" of the probability distribution in collected values within the defined evaluation period. See also: [Kurtosis](#).
 Supported value types: *Float*, *Integer*.
 Supported **foreach function**: `last_foreach`.

Parameters: see [common parameters](#).

Example:

```
kurtosis(/host/key,1h) #kurtosis for the last hour until now
mad(/host/key,(sec|#num)<:time shift>)
```

The median absolute deviation in collected values within the defined evaluation period. See also: [Median absolute deviation](#).
 Supported value types: *Float*, *Integer*.
 Supported **foreach function**: `last_foreach`.

Parameters: see [common parameters](#).

Example:

```
mad(/host/key,1h) #median absolute deviation for the last hour until now
max(/host/key,(sec|#num)<:time shift>)
```

The highest value of an item within the defined evaluation period.
 Supported value types: *Float*, *Integer*.
 Supported **foreach functions**: `avg_foreach`, `count_foreach`, `exists_foreach`, `last_foreach`, `max_foreach`, `min_foreach`, `sum_foreach`.

Parameters: see [common parameters](#).

Example:

```
max(/host/key,1h) - min(/host/key,1h) #calculate the difference between the maximum and minimum values wit
min(/host/key,(sec|#num)<:time shift>)
```

The lowest value of an item within the defined evaluation period.
 Supported value types: *Float*, *Integer*.
 Supported **foreach functions**: `avg_foreach`, `count_foreach`, `exists_foreach`, `last_foreach`, `max_foreach`, `min_foreach`, `sum_foreach`.

Parameters: see [common parameters](#).

Example:

```
max(/host/key,1h) - min(/host/key,1h) #calculate the difference between the maximum and minimum values wit
skewness(/host/key,(sec|#num)<:time shift>)
```

The asymmetry of the probability distribution in collected values within the defined evaluation period. See also: [Skewness](#).
 Supported value types: *Float*, *Integer*.
 Supported **foreach function**: `last_foreach`.

Parameters: see [common parameters](#).

Example:

```
skewness(/host/key,1h) #the skewness for the last hour until now
stddevpop(/host/key,(sec|#num)<:time shift>)
```

The population standard deviation in collected values within the defined evaluation period. See also: [Standard deviation](#).
 Supported value types: *Float*, *Integer*.
 Supported **foreach function**: *last_foreach*.

Parameters: see [common parameters](#).

Example:

```
stddevpop(/host/key,1h) #the population standard deviation for the last hour until now
stddevsamp(/host/key,(sec|#num)<:time shift>)
```

The sample standard deviation in collected values within the defined evaluation period. See also: [Standard deviation](#).
 Supported value types: *Float*, *Integer*.
 Supported **foreach function**: *last_foreach*.

Parameters: see [common parameters](#).

At least two data values are required for this function to work.

Example:

```
stddevsamp(/host/key,1h) #the sample standard deviation for the last hour until now
sum(/host/key,(sec|#num)<:time shift>)
```

The sum of collected values within the defined evaluation period.
 Supported value types: *Float*, *Integer*.
 Supported **foreach functions**: *avg_foreach*, *count_foreach*, *exists_foreach*, *last_foreach*, *max_foreach*, *min_foreach*, *sum_foreach*.

Parameters: see [common parameters](#).

Example:

```
sum(/host/key,1h) #the sum of values for the last hour until now
sumofsquares(/host/key,(sec|#num)<:time shift>)
```

The sum of squares in collected values within the defined evaluation period.
 Supported value types: *Float*, *Integer*.
 Supported **foreach function**: *last_foreach*.

Parameters: see [common parameters](#).

Example:

```
sumofsquares(/host/key,1h) #the sum of squares for the last hour until now
varpop(/host/key,(sec|#num)<:time shift>)
```

The population variance of collected values within the defined evaluation period. See also: [Variance](#).
 Supported value types: *Float*, *Integer*.
 Supported **foreach function**: *last_foreach*.

Parameters: see [common parameters](#).

Example:

```
varpop(/host/key,1h) #the population variance for the last hour until now
varsamp(/host/key,(sec|#num)<:time shift>)
```

The sample variance of collected values within the defined evaluation period. See also: [Variance](#).
 Supported value types: *Float*, *Integer*.
 Supported **foreach function**: *last_foreach*.

Parameters: see [common parameters](#).

At least two data values are required for this function to work.

Example:

```
varsamp(/host/key,1h) #the sample variance for the last hour until now
```

See [all supported functions](#).

1 Foreach functions

Overview

Foreach functions are used in **aggregate calculations** to return one aggregate value for each item that is selected by the used **item filter**. An array of values is returned.

For example, the *avg_foreach* function will return an array of values, where each value is the *average* history value of the selected item, during the time interval that is specified.

The **item filter** is part of the syntax used by foreach functions. The use of wildcards is supported in the item filter, thus the required items can be selected quite flexibly.

Supported functions

Function	Description
<i>avg_foreach</i>	Returns the average value for each item.
<i>bucket_rate_foreach</i>	Returns pairs (bucket upper bound, rate value) suitable for use in the <i>histogram_quantile()</i> function, where "bucket upper bound" is the value of item key parameter defined by the <parameter number> parameter .
<i>count_foreach</i>	Returns the number of values for each item.
<i>exists_foreach</i>	Returns '1' for each enabled item.
<i>last_foreach</i>	Returns the last value for each item.
<i>max_foreach</i>	Returns the maximum value for each item.
<i>min_foreach</i>	Returns the minimum value for each item.
<i>sum_foreach</i>	Returns the sum of values for each item.

Function syntax

Foreach functions support two common parameters: **item filter** (see details below) and **time period**:

```
foreach_function(item filter,time period)
```

For example:

```
avg_foreach(/*/mysql.qps?[group="MySQL Servers"],5m)
```

will return the five-minute average of each 'mysql.qps' item in the MySQL server group.

Note that some functions support additional **parameters**.

Item filter syntax

The item filter:

```
/host/key [parameters] ? [conditions]
```

consists of four parts, where:

- host - host name
- key - item key (without parameters)
- parameters - item key parameters
- conditions - host group and/or item tag based conditions (as expression)

Spaces are allowed only inside the conditions expression.

Wildcard usage

- Wildcard can be used to replace the host name, item key or an individual item key parameter.
- Either the host or item key must be specified without wildcard. So */host/** and */*/key* are valid filters, but **/** is invalid.
- Wildcard cannot be used for a *part* of host name, item key, item key parameter.
- Wildcard does not match more than a single item key parameter. So a wildcard must be specified for each parameter in separation (i.e. *key[abc,*,*]*).

Conditions expression

The conditions expression supports:

- operands:
 - group - host group
 - tag - item tag
 - "<text>" - string constant, with the \ escape character to escape " and \

- case-sensitive string comparison operators: =, <>
- logical operators: and, or, not
- grouping with parentheses: ()

Quotation of string constants is mandatory. Only case-sensitive full string comparison is supported.

Warning:

When specifying tags in the filter (i.e. tag="tagname:value"), the colon ":" is used as a delimiter. Everything after it is considered the tag value. Thus it is currently not supported to specify a tag name containing ":" in it.

Examples

A complex filter may be used, referencing the item key, host group and tags, as illustrated by the examples:

Syntax example	Description
/host/key[abc,*]	Matches similar items on this host.
/*/key	Matches the same item of any host.
*/key?[group="ABC" and tag="tagname:value"]	Matches the same item of any host from the ABC group having 'tagname:value' tags.
/key[a, ,c]?[(group="ABC" and tag="Tag1") or (group="DEF" and (tag="Tag2" or tag="Tag3:value"))]	Matches similar items of any host from the ABC or DEF group with the respective tags.

All referenced items must exist and collect data. Only enabled items on enabled hosts are included in the calculations. Items in the unsupported state are not included.

Attention:

If the item key of a referenced item is changed, the filter must be updated manually.

Specifying a parent host group includes the parent group and all nested host groups with their items.

Time period

The **second** parameter allows to specify the time period for aggregation. The time period can only be expressed as time, the amount of values (prefixed with #) is not supported.

Supported unit symbols can be used in this parameter for convenience, for example, '5m' (five minutes) instead of '300s' (300 seconds) or '1d' (one day) instead of '86400' (86400 seconds).

For the *last_foreach* function time period is an optional parameter (supported since Zabbix 7.0), which can be omitted:

```
last_foreach(*/key?[group="host group"])
```

Time period is not supported with the *exists_foreach* function.

Additional parameters

bucket_rate_foreach

A third optional parameter is supported by the *bucket_rate_foreach* function:

```
bucket_rate_foreach(item filter,time period,<parameter number>)
```

where <parameter number> is the position of the "bucket" value in the item key. For example, if the "bucket" value in myItem[aaa,0.2] is '0.2', then its position is 2.

The default value of <parameter number> is '1'.

count_foreach

Third and fourth optional parameters are supported by the *count_foreach* function:

```
count_foreach(item filter,time period,<operator>,<pattern>)
```

Where:

- **operator** is the conditional operator for item values (must be double-quoted). Supported operators:
eq - equal
ne - not equal
gt - greater
ge - greater or equal
lt - less
le - less or equal
like - matches if contains pattern (case-sensitive)
bitand - bitwise AND
regex - case-sensitive match of the regular expression given in pattern
iregex - case-insensitive match of the regular expression given in pattern

- **pattern** is the required pattern (string arguments must be double-quoted); supported if *operator* is specified in the third parameter.

Comments:

- Optional parameters *operator* or *pattern* can't be left empty after a comma, only fully omitted.
- With *bitand* as the third parameter, the fourth *pattern* parameter can be specified as two numbers, separated by '/': **number_to_compare_with/mask**. `count()` calculates "bitwise AND" from the value and the *mask* and compares the result to *number_to_compare_with*. If the result of "bitwise AND" is equal to *number_to_compare_with*, the value is counted.
 If *number_to_compare_with* and *mask* are equal, only the *mask* need be specified (without '/').
- With *regex* or *iregex* as the third parameter, the fourth *pattern* parameter can be an ordinary or **global** (starting with '@') regular expression. In case of global regular expressions case sensitivity is inherited from global regular expression settings. For the purpose of regex matching, float values will always be represented with 4 decimal digits after '.'. Also note that for large numbers difference in decimal (stored in database) and binary (used by Zabbix server) representation may affect the 4th decimal digit.

See [aggregate calculations](#) for more details and examples on using foreach functions.

Behavior depending on availability

The following table illustrates how each function behaves in cases of limited availability of host/item and history data.

Function	Disabled host	Unavailable host with data	Unavailable host without data	Disabled item	Unsupported item	Data retrieval error (SQL)
<i>avg_foreach</i>	ignore	return avg	ignore	ignore	ignore	ignore
<i>bucket_rate_foreach</i>	ignore	return bucket rate	ignore	ignore	ignore	ignore
<i>count_foreach</i>	ignore	return count	0	ignore	ignore	ignore
<i>exists_foreach</i>	ignore	1	1	ignore	1	n/a
<i>last_foreach</i>	ignore	return last	ignore	ignore	ignore	ignore
<i>max_foreach</i>	ignore	return max	ignore	ignore	ignore	ignore
<i>min_foreach</i>	ignore	return min	ignore	ignore	ignore	ignore
<i>sum_foreach</i>	ignore	return sum	ignore	ignore	ignore	ignore

If the item is *ignored*, nothing is added to the aggregation.

2 Bitwise functions

All functions listed here are supported in:

- [Trigger expressions](#)
- [Calculated items](#)

The functions are listed without additional information. Click on the function to see the full details.

Function	Description
bitand	The value of "bitwise AND" of an item value and mask.
bitlshift	The bitwise shift left of an item value.
bitnot	The value of "bitwise NOT" of an item value.
bitor	The value of "bitwise OR" of an item value and mask.
bitrshift	The bitwise shift right of an item value.
bitxor	The value of "bitwise exclusive OR" of an item value and mask.

Function details

Some general notes on function parameters:

- Function parameters are separated by a comma
- Expressions are accepted as parameters
- Optional function parameters (or parameter parts) are indicated by < >

`bitand(value,mask)`

The value of "bitwise AND" of an item value and mask.
 Supported value types: *Integer*.

Parameter:

- **value** - the value to check;
- **mask** (mandatory) - a 64-bit unsigned integer (0 - 18446744073709551615).

Although the comparison is done in a bitwise manner, all the values must be supplied and are returned in decimal. For example, checking for the 3rd bit is done by comparing to 4, not 100.

Examples:

`bitand(last(/host/key),12)=8` or `bitand(last(/host/key),12)=4` #3rd or 4th bit set, but not both at the same time
`bitand(last(/host/key),20)=16` #3rd bit not set and 5th bit set

`bitlshift(value,bits to shift)`

The bitwise shift left of an item value.
 Supported value types: *Integer*.

Parameter:

- **value** - the value to check;
- **bits to shift** (mandatory) - the number of bits to shift.

Although the comparison is done in a bitwise manner, all the values must be supplied and are returned in decimal. For example, checking for the 3rd bit is done by comparing to 4, not 100.

`bitnot(value)`

The value of "bitwise NOT" of an item value.
 Supported value types: *Integer*.

Parameter:

- **value** - the value to check.

Although the comparison is done in a bitwise manner, all the values must be supplied and are returned in decimal. For example, checking for the 3rd bit is done by comparing to 4, not 100.

`bitor(value,mask)`

The value of "bitwise OR" of an item value and mask.
 Supported value types: *Integer*.

Parameter:

- **value** - the value to check;
- **mask** (mandatory) - a 64-bit unsigned integer (0 - 18446744073709551615).

Although the comparison is done in a bitwise manner, all the values must be supplied and are returned in decimal. For example, checking for the 3rd bit is done by comparing to 4, not 100.

`bitrshift(value,bits to shift)`

The bitwise shift right of an item value.
 Supported value types: *Integer*.

Parameter:

- **value** - the value to check;
- **bits to shift** (mandatory) - the number of bits to shift.

Although the comparison is done in a bitwise manner, all the values must be supplied and are returned in decimal. For example, checking for the 3rd bit is done by comparing to 4, not 100.

`bitxor(value,mask)`

The value of "bitwise exclusive OR" of an item value and mask.
 Supported value types: *Integer*.

Parameter:

- **value** - the value to check;
- **mask** (mandatory) - a 64-bit unsigned integer (0 - 18446744073709551615).

Although the comparison is done in a bitwise manner, all the values must be supplied and are returned in decimal. For example, checking for the 3rd bit is done by comparing to 4, not 100.

See [all supported functions](#).

3 Date and time functions

All functions listed here are supported in:

- [Trigger expressions](#)

- [Calculated items](#)

Attention:

Date and time functions cannot be used in the expression by themselves; at least one function from [another group](#), referencing the host item, must be included in the expression (except the [nodata\(\)](#) function). For detailed information on how date and time functions work within expressions, see [Calculation time](#).

The functions are listed without additional information. Click on the function to see the full details.

Function	Description
date	The current date in YYYYMMDD format.
dayofmonth	The day of month in range of 1 to 31.
dayofweek	The day of week in range of 1 to 7.
now	The number of seconds since the Epoch (00:00:00 UTC, January 1, 1970).
time	The current time in HHMMSS format.

Function details

[date](#)

The current date in YYYYMMDD format.

Example:

`date()<20220101`

[dayofmonth](#)

The day of month in range of 1 to 31.

Example:

`dayofmonth()=1`

[dayofweek](#)

The day of week in range of 1 to 7 (Mon - 1, Sun - 7).

Example (only weekdays):

`dayofweek()<6`

Example (only weekend):

`dayofweek()>5`

[now](#)

The number of seconds since the Epoch (00:00:00 UTC, January 1, 1970).

Example:

`now()<1640998800`

[time](#)

The current time in HHMMSS format.

Example (only nighttime, 00:00-06:00):

`time()<060000`

See [all supported functions](#).

4 History functions

All functions listed here are supported in:

- [Trigger expressions](#)
- [Calculated items](#)

The functions are listed without additional information. Click on the function to see the full details.

Function	Description
<code>change</code>	The amount of difference between the previous and latest value.
<code>changecount</code>	The number of changes between adjacent values within the defined evaluation period.
<code>count</code>	The number of values within the defined evaluation period.
<code>countunique</code>	The number of unique values within the defined evaluation period.
<code>find</code>	Find a value match within the defined evaluation period.
<code>first</code>	The first (the oldest) value within the defined evaluation period.
<code>fuzzytime</code>	Check how much the passive agent time differs from the Zabbix server/proxy time.
<code>last</code>	The most recent value.
<code>logeventid</code>	Check if the event ID of the last log entry matches a regular expression.
<code>logseverity</code>	The log severity of the last log entry.
<code>logsource</code>	Check if log source of the last log entry matches a regular expression.
<code>monodec</code>	Check if there has been a monotonous decrease in values.
<code>monoinc</code>	Check if there has been a monotonous increase in values.
<code>nodata</code>	Check for no data received.
<code>percentile</code>	The P-th percentile of a period, where P (percentage) is specified by the third parameter.
<code>rate</code>	The per-second average rate of the increase in a monotonically increasing counter within the defined time period.

Common parameters

- `/host/key` is a common mandatory first parameter for the functions referencing the host item history
- `(sec|#num)<:time shift>` is a common second parameter for the functions referencing the host item history, where:
 - **sec** - maximum **evaluation period** in seconds (time **suffixes** can be used), or
 - **#num** - maximum **evaluation range** in latest collected values (if preceded by a hash mark)
 - **time shift** (optional) allows to move the evaluation point back in time. See [more details](#) on specifying time shift.

Function details

Some general notes on function parameters:

- Function parameters are separated by a comma
- Optional function parameters (or parameter parts) are indicated by `< >`
- Function-specific parameters are described with each function
- `/host/key` and `(sec|#num)<:time shift>` parameters must never be quoted

`change(/host/key)`

The amount of difference between the previous and latest value.
 Supported value types: *Float, Integer, String, Text, Log*.
 For strings returns: 0 - values are equal; 1 - values differ.

Parameters: see [common parameters](#).

Comments:

- Numeric difference will be calculated, as seen with these incoming example values ('previous' and 'latest' value = difference): `
'1' and '5' = +4
'3' and '1' = -2
'0' and '-2.5' = -2.5
`
- See also: [abs](#) for comparison.

Examples:

```
change(/host/key)>10
```

```
changecount(/host/key,(sec|#num)<:time shift>,<mode>)
```

The number of changes between adjacent values within the defined evaluation period.
 Supported value types: *Float, Integer, String, Text, Log*.

Parameters:

- See [common parameters](#);
- **mode** (must be double-quoted) - possible values: *all* - count all changes (default); *dec* - count decreases; *inc* - count increases

For non-numeric value types, the *mode* parameter is ignored.

Examples:

```
changecount(/host/key,1w) #the number of value changes for the last week until now
```

```
changecount(/host/key,#10,"inc") #the number of value increases (relative to the adjacent value) among the
```

```
changecount(/host/key,24h,"dec") #the number of value decreases (relative to the adjacent value) for the 1
```

count(/host/key,(sec|#num)<:time shift>,<operator>,<pattern>)

The number of values within the defined evaluation period.
 Supported value types: *Float, Integer, String, Text, Log*.

Parameters:

- See [common parameters](#);

- **operator** (must be double-quoted). Supported operators:
eq - equal (default for integer, float)
ne - not equal
gt - greater
ge - greater or equal
lt - less
le - less or equal
like (default for string, text, log) - matches if contains pattern (case-sensitive)
bitand - bitwise AND
regexp - case-sensitive match of the regular expression given in *pattern*
iregexp - case-insensitive match of the regular expression given in *pattern*

- **pattern** - the required pattern (string arguments must be double-quoted).

Comments:

- Float items match with the precision of 2.22e-16;
- *like* is not supported as operator for integer values;
- *like* and *bitand* are not supported as operators for float values;
- For string, text, and log values only *eq*, *ne*, *like*, *regexp* and *iregexp* operators are supported;
- With *bitand* as operator, the fourth *pattern* parameter can be specified as two numbers, separated by '/': **number_to_compare_with/mask**. *count()* calculates "bitwise AND" from the value and the *mask* and compares the result to *number_to_compare_with*. If the result of "bitwise AND" is equal to *number_to_compare_with*, the value is counted.
If *number_to_compare_with* and *mask* are equal, only the *mask* need be specified (without '/').
- With *regexp* or *iregexp* as operator, the fourth *pattern* parameter can be an ordinary or **global** (starting with '@') regular expression. In case of global regular expressions case sensitivity is inherited from global regular expression settings. For the purpose of regexp matching, float values will always be represented with 4 decimal digits after '.'. Also note that for large numbers difference in decimal (stored in database) and binary (used by Zabbix server) representation may affect the 4th decimal digit.

Examples:

```
count(/host/key,10m) #the values for the last 10 minutes until now
count(/host/key,10m,"like","error") #the number of values for the last 10 minutes until now that contain 'error'
count(/host/key,10m,,12) #the number of values for the last 10 minutes until now that equal '12'
count(/host/key,10m,"gt",12) #the number of values for the last 10 minutes until now that are over '12'
count(/host/key,#10,"gt",12) #the number of values within the last 10 values until now that are over '12'
count(/host/key,10m:now-1d,"gt",12) #the number of values between 24 hours and 10 minutes and 24 hours ago
count(/host/key,10m,"bitand","6/7") #the number of values for the last 10 minutes until now having '110' (10110)
count(/host/key,10m:now-1d) #the number of values between 24 hours and 10 minutes and 24 hours ago from now
```

countunique(/host/key,(sec|#num)<:time shift>,<operator>,<pattern>)

The number of unique values within the defined evaluation period.
 Supported value types: *Float, Integer, String, Text, Log*.

Parameters:

- See [common parameters](#);

- **operator** (must be double-quoted). Supported operators:
eq - equal (default for integer, float)
ne - not equal
gt - greater
ge - greater or equal
lt - less
le - less or equal
like (default for string, text, log) - matches if contains pattern (case-sensitive)
bitand - bitwise AND
regexp - case-sensitive match of the regular expression given in *pattern*
iregexp - case-insensitive match of the regular expression given in *pattern*

- **pattern** - the required pattern (string arguments must be double-quoted).

Comments:

- Float items match with the precision of 2.22e-16;
- *like* is not supported as operator for integer values;
- *like* and *bitand* are not supported as operators for float values;
- For string, text, and log values only *eq*, *ne*, *like*, *regexp* and *iregexp* operators are supported;
- With *bitand* as operator, the fourth *pattern* parameter can be specified as two numbers, separated by '/': **number_to_compare_with/mask**. *countunique()* calculates "bitwise AND" from the value and the *mask* and compares the result to *number_to_compare_with*. If the result of "bitwise AND" is equal to *number_to_compare_with*, the value is counted.
If *number_to_compare_with* and *mask* are equal, only the *mask* need be specified (without '/').
- With *regexp* or *iregexp* as operator, the fourth *pattern* parameter can be an ordinary or **global** (starting with '@') regular expression. In case of global regular expressions case sensitivity is inherited from global regular expression settings. For the purpose of regexp matching, float values will always be represented with 4 decimal digits after '.'. Also note that for large numbers difference in decimal (stored in database) and binary (used by Zabbix server) representation may affect the 4th decimal digit.

Examples:

```

countunique(/host/key,10m) #the number of unique values for the last 10 minutes until now
countunique(/host/key,10m,"like","error") #the number of unique values for the last 10 minutes until now t
countunique(/host/key,10m,,12) #the number of unique values for the last 10 minutes until now that equal '
countunique(/host/key,10m,"gt",12) #the number of unique values for the last 10 minutes until now that are
countunique(/host/key,#10,"gt",12) #the number of unique values within the last 10 values until now that a
countunique(/host/key,10m:now-1d,"gt",12) #the number of unique values between 24 hours and 10 minutes and
countunique(/host/key,10m,"bitand","6/7") #the number of unique values for the last 10 minutes until now h
countunique(/host/key,10m:now-1d) #the number of unique values between 24 hours and 10 minutes and 24 hour

find(/host/key,(sec|#num)<:time shift>,<operator>,<pattern>)

```

Find a value match within the defined evaluation period.
 Supported value types: *Float, Integer, String, Text, Log*.
 Returns: 1 - found; 0 - otherwise.

Parameters:

- See [common parameters](#);

- **sec** or **#num** (optional) - defaults to the latest value if not specified
- **operator** (must be double-quoted). Supported operators:
eq - equal (default for integer, float)
ne - not equal
gt - greater
ge - greater or equal
lt - less
le - less or equal
like (default for string, text, log) - matches if contains the string given in *pattern* (case-sensitive)
bitand - bitwise AND
regex - case-sensitive match of the regular expression given in *pattern*
iregexp - case-insensitive match of the regular expression given in *pattern*

- **pattern** - the required pattern (string arguments must be double-quoted); [Perl Compatible Regular Expression](#) (PCRE) regular expression if *operator* is *regex*, *iregexp*.

Comments:

- If more than one value is processed, '1' is returned if there is at least one matching value;
- *like* is not supported as operator for integer values;
- *like* and *bitand* are not supported as operators for float values;
- For string, text, and log values only *eq*, *ne*, *like*, *regex* and *iregexp* operators are supported;
- With *regex* or *iregexp* as operator, the fourth *pattern* parameter can be an ordinary or **global** (starting with '@') regular expression. In case of global regular expressions case sensitivity is inherited from the global regular expression settings.

Example:

```

find(/host/key,10m,"like","error") #find a value that contains 'error' within the last 10 minutes until no
first(/host/key,sec<:time shift>)

```

The first (the oldest) value within the defined evaluation period.
 Supported value types: *Float, Integer, String, Text, Log*.

Parameters:

- See [common parameters](#).

See also [last\(\)](#).

Example:

```

first(/host/key,1h) #retrieve the oldest value within the last hour until now
fuzzytime(/host/key,sec)

```

Check how much the passive agent time differs from the Zabbix server/proxy time.
 Supported value types: *Float, Integer*.
 Returns: 1 - difference between the passive item value (as timestamp) and Zabbix server/proxy timestamp (the clock of value collection) is less than or equal to T seconds; 0 - otherwise.

Parameters:

- See [common parameters](#).

Comments:

- Usually used with the 'system.localtime' item to check that local time is in sync with the local time of Zabbix server. *Note* that 'system.localtime' must be configured as a **passive check**.
- Can be used also with the `vfs.file.time[/path/file,modify]` key to check that the file did not get updates for long time;
- This function is not recommended for use in complex trigger expressions (with multiple items involved), because it may cause unexpected results (time difference will be measured with the most recent metric), e.g. in `fuzzytime(/Host/system.localtime,60)` or `last(/Host/trap)<>0`.

Example:

fuzzytime(/host/key,60s)=0 #detect a problem if the time difference is over 60 seconds

last(/host/key,<#num<:time shift>)

The most recent value.
 Supported value types: *Float, Integer, String, Text, Log*.

Parameters:

- See [common parameters](#);

- **#num** (optional) - the Nth most recent value.

Comments:

- Take note that a hash-tagged time period (#N) works differently here than with many other functions. For example: last(/host/key) is always equal to last(/host/key,#1); last(/host/key,#3) - the third most recent value (*not* three latest values);
- Zabbix does not guarantee the exact order of values if more than two values exist within one second in history;
- See also [first\(\)](#).

Example:

```
last(/host/key) #retrieve the last value
last(/host/key,#2) #retrieve the previous value
last(/host/key,#1) <> last(/host/key,#2) #the last and previous values differ
```

logeventid(/host/key,<#num<:time shift>,<pattern>)

Check if the event ID of the last log entry matches a regular expression.
 Supported value types: *Log*.
 Returns: 0 - does not match; 1 - matches.

Parameters:

- See [common parameters](#);

- **#num** (optional) - the Nth most recent value;

- **pattern** (optional) - the regular expression describing the required pattern, [Perl Compatible Regular Expression \(PCRE\)](#) style (string arguments must be double-quoted).

logseverity(/host/key,<#num<:time shift>)

Log severity of the last log entry.
 Supported value types: *Log*.
 Returns: 0 - default severity; N - severity (integer, useful for Windows event logs: 1 - Information, 2 - Warning, 4 - Error, 7 - Failure Audit, 8 - Success Audit, 9 - Critical, 10 - Verbose).

Parameters:

- See [common parameters](#);

- **#num** (optional) - the Nth most recent value.

Zabbix takes log severity from the **Information** field of Windows event log.

logsource(/host/key,<#num<:time shift>,<pattern>)

Check if log source of the last log entry matches a regular expression.
 Supported value types: *Log*.
 Returns: 0 - does not match; 1 - matches.

Parameters:

- See [common parameters](#);

- **#num** (optional) - the Nth most recent value;

- **pattern** (optional) - the regular expression describing the required pattern, [Perl Compatible Regular Expression \(PCRE\)](#) style (string arguments must be double-quoted).

Normally used for Windows event logs.

Example:

```
logsource(/host/key,,"VMware Server")
monodec(/host/key,(sec|#num)<:time shift>,<mode>)
```

Check if there has been a monotonous decrease in values.
 Supported value types: *Integer*.
 Returns: 1 - if all elements in the time period continuously decrease; 0 - otherwise.

Parameters:

- See [common parameters](#);

- **mode** (must be double-quoted) - *weak* (every value is smaller or the same as the previous one; default) or *strict* (every value has decreased).

Example:

```
monodec(/Host1/system.swap.size[all,free],60s) + monodec(/Host2/system.swap.size[all,free],60s) + monodec(
monoinc(/host/key,(sec|#num)<:time shift>,<mode>)
```

Check if there has been a monotonous increase in values.
 Supported value types: *Integer*.
 Returns: 1 - if all elements in the time period continuously increase; 0 - otherwise.

Parameters:

- See [common parameters](#);

- **mode** (must be double-quoted) - *weak* (every value is bigger or the same as the previous one; default) or *strict* (every value has increased).

Example:

```
monoinc(/Host1/system.localtime,#3,"strict")=0 #check if the system local time has been increasing consist
nodata(/host/key,sec,<mode>)
```

Check for no data received.
 Supported value types: *Integer, Float, Character, Text, Log*.
 Returns: 1 - if no data received during the defined period of time; 0 - otherwise.

Parameters:

- See [common parameters](#);

- **sec** - the period should not be less than 30 seconds because the history syncer process calculates this function only every 30 seconds; `nodata(/host/key,0)` is disallowed.
- **mode** - if set to *strict* (double-quoted), this function will be insensitive to proxy availability (see comments for details).

Comments:

- the 'nodata' triggers monitored by proxy are, by default, sensitive to proxy availability - if proxy becomes unavailable, the 'nodata' triggers will not fire immediately after a restored connection, but will skip the data for the delayed period. Note that for passive proxies suppression is activated if connection is restored more than 15 seconds and no less than 2 seconds later. For active proxies suppression is activated if connection is restored more than 15 seconds later. To turn off sensitiveness to proxy availability, use the third parameter, e.g.: `nodata(/host/key,5m,"strict")`; in this case the function will fire as soon as the evaluation period (five minutes) without data has past.

- This function will display an error if, within the period of the 1st parameter:
- there's no data and Zabbix server was restarted
- there's no data and maintenance was completed
- there's no data and the item was added or re-enabled

- Errors are displayed in the *Info* column in trigger [configuration](#);

- This function may not work properly if there are time differences between Zabbix server, proxy and agent. See also: [Time synchronization requirement](#);

- `nodata()` function cannot be used in the expression by itself; at least one function from [another group](#), referencing the host item, must be included in the expression (except [date and time functions](#)). For detailed information on how the `nodata()` function works within expressions, see [Calculation time](#).

```
percentile(/host/key,(sec|#num)<:time shift>,percentage)
```

The P-th percentile of a period, where P (percentage) is specified by the third parameter.
 Supported value types: *Float, Integer*.

Parameters:

- See [common parameters](#);

- **percentage** - a floating-point number between 0 and 100 (inclusive) with up to 4 digits after the decimal point.

```
rate(/host/key,sec<:time shift>)
```

The per-second average rate of the increase in a monotonically increasing counter within the defined time period.
 Supported value types: *Float, Integer*.

Parameters:

- See [common parameters](#).

Functionally corresponds to 'rate' of PromQL.

Example:

```
rate(/host/key,30s) #if the monotonic increase over 30 seconds is 20, this function will return 0.67.
```

See [all supported functions](#).

5 Trend functions

Trend functions, in contrast to [history functions](#), use [trend](#) data for calculations.

Trends store hourly aggregate values. Trend functions use these hourly averages, and thus are useful for long-term analysis.

Trend function results are cached so multiple calls to the same function with the same parameters fetch info from the database only once. The trend function cache is controlled by the [TrendFunctionCacheSize](#) server parameter.

Triggers that reference trend functions **only** are evaluated once per the smallest time period in the expression. For instance, a trigger like

```
trendavg(/host/key,1d:now/d) > 1 or trendavg(/host/key2,1w:now/w) > 2
```

will be evaluated once per day. If the trigger contains both trend and history (or [date and time](#) and/or [nodata\(\)](#)) functions, it is calculated in accordance with the [usual principles](#).

All functions listed here are supported in:

- [Trigger expressions](#)
- [Calculated items](#)

The functions are listed without additional information. Click on the function to see the full details.

Function	Description
baselinedev	Returns the number of deviations (by <code>stddevpop</code> algorithm) between the last data period and the same data periods in preceding seasons.
baselinewma	Calculates the baseline by averaging data from the same timeframe in multiple equal time periods ('seasons') using the weighted moving average algorithm.
trendavg	The average of trend values within the defined time period.
trendcount	The number of successfully retrieved history values used to calculate the trend value within the defined time period.
trendmax	The maximum in trend values within the defined time period.
trendmin	The minimum in trend values within the defined time period.
trendstl	Returns the rate of anomalies during the detection period - a decimal value between 0 and 1 that is $((\text{the number of anomaly values})/(\text{total number of values}))$.
trendsum	The sum of trend values within the defined time period.

Common parameters

- `/host/key` is a common mandatory first parameter
- `time period:time shift` is a common second parameter, where:
 - **time period** - the time period (minimum '1h'), defined as `<N><time unit>` where `N` - the number of time units, `time unit` - h (hour), d (day), w (week), M (month) or y (year).
 - **time shift** - the [time period offset](#) (see function examples)

Function details

Some general notes on function parameters:

- Function parameters are separated by a comma
- Optional function parameters (or parameter parts) are indicated by `< >`
- Function-specific parameters are described with each function
- `/host/key` and `time period:time shift` parameters must never be quoted

`baselinedev(/host/key,data period:time shift,season unit,num seasons)`

Returns the number of deviations (by `stddevpop` algorithm) between the last data period and the same data periods in preceding seasons.

Parameters:

- See [common parameters](#);

- **data period** - the data gathering period within a season, defined as `<N><time unit>` where:
`N` - the number of time units
`time unit` - h (hour), d (day), w (week), M (month) or y (year), must be equal to or less than `season`

- **season unit** - the duration of one season (h, d, w, M, y), cannot be smaller than `data period`;
- **num seasons** - the number of seasons to evaluate.

Examples:

```
baselinedev(/host/key,1d:now/d,"M",6) #calculating the number of standard deviations (population) between
baselinedev(/host/key,1h:now/h,"d",10) #calculating the number of standard deviations (population) between
baselinewma(/host/key,data period:time shift,season unit,num seasons)
```

Calculates the baseline by averaging data from the same timeframe in multiple equal time periods ('seasons') using the weighted moving average algorithm.

Parameters:

- See [common parameters](#);

- **data period** - the data gathering period within a season, defined as <N><time unit> where:
N - the number of time units
time unit - h (hour), d (day), w (week), M (month) or y (year), must be equal to or less than season
Time shift - the time period offset, defines the end of data gathering time frame in seasons (see examples);

- **season unit** - the duration of one season (h, d, w, M, y), cannot be smaller than data period;

- **num seasons** - the number of seasons to evaluate.

Examples:

```
baselinewma(/host/key,1h:now/h,"d",3) #calculating the baseline based on the last full hour within a 3-day
baselinewma(/host/key,2h:now/h,"d",3) #calculating the baseline based on the last two hours within a 3-day
baselinewma(/host/key,1d:now/d,"M",4) #calculating the baseline based on the same day of month as 'yesterday'
trendavg(/host/key,time period:time shift)
```

The average of trend values within the defined time period.

Parameters:

- See [common parameters](#).

Examples:

```
trendavg(/host/key,1h:now/h) #the average for the previous hour (e.g. 12:00-13:00)
trendavg(/host/key,1h:now/h-1h) #the average for two hours ago (11:00-12:00)
trendavg(/host/key,1h:now/h-2h) #the average for three hours ago (10:00-11:00)
trendavg(/host/key,1M:now/M-1y) #the average for the previous month a year ago
trendcount(/host/key,time period:time shift)
```

The number of successfully retrieved history values used to calculate the trend value within the defined time period.

Parameters:

- See [common parameters](#).

Examples:

```
trendcount(/host/key,1h:now/h) #the value count for the previous hour (e.g. 12:00-13:00)
trendcount(/host/key,1h:now/h-1h) #the value count for two hours ago (11:00-12:00)
trendcount(/host/key,1h:now/h-2h) #the value count for three hours ago (10:00-11:00)
trendcount(/host/key,1M:now/M-1y) #the value count for the previous month a year ago
trendmax(/host/key,time period:time shift)
```

The maximum in trend values within the defined time period.

Parameters:

- See [common parameters](#).

Examples:

```
trendmax(/host/key,1h:now/h) #the maximum for the previous hour (e.g. 12:00-13:00)
trendmax(/host/key,1h:now/h) - trendmin(/host/key,1h:now/h) → calculate the difference between the maximum
trendmax(/host/key,1h:now/h-1h) #the maximum for two hours ago (11:00-12:00)
trendmax(/host/key,1h:now/h-2h) #the maximum for three hours ago (10:00-11:00)
trendmax(/host/key,1M:now/M-1y) #the maximum for the previous month a year ago
trendmin(/host/key,time period:time shift)
```

The minimum in trend values within the defined time period.

Parameters:

- See [common parameters](#).

Examples:

```
trendmin(/host/key,1h:now/h) #the minimum for the previous hour (e.g. 12:00-13:00)
trendmax(/host/key,1h:now/h) - trendmin(/host/key,1h:now/h) → calculate the difference between the maximum and minimum
trendmin(/host/key,1h:now/h-1h) #the minimum for two hours ago (11:00-12:00)
trendmin(/host/key,1h:now/h-2h) #the minimum for three hours ago (10:00-11:00)
trendmin(/host/key,1M:now/M-1y) #the minimum for the previous month a year ago

trendstl(/host/key,eval period:time shift,detection period,season,<deviations>,<devalg>,<s window>)
```

Returns the rate of anomalies during the detection period - a decimal value between 0 and 1 that is ((the number of anomaly values)/(total number of values)).

Parameters:

- See [common parameters](#);

- **eval period** - the time period that must be decomposed (minimum '1h'), defined as <N><time unit> where
N - the number of time units
time unit - h (hour), d (day), w (week), M (month) or y (year)

- **detection period** - the time period before the end of eval period for which anomalies are calculated (minimum '1h', cannot be longer than eval period), defined as <N><time unit> where
N - the number of time units
time unit - h (hour), d (day), w (week)

- **season** - the shortest time period where a repeating pattern ("season") is expected (minimum '2h', cannot be longer than eval period, the number of entries in the eval period must be greater than the two times of the resulting frequency (season/h)), defined as <N><time unit> where
N - the number of time units
time unit - h (hour), d (day), w (week)
- **deviations** - the number of deviations (calculated by devalg) to count as anomaly (can be decimal), (must be greater than or equal to 1, default is 3);
- **devalg** (must be double-quoted) - the deviation algorithm, can be *stddevpop*, *stddevsamp* or *mad* (default);
- **s window** - the span (in lags) of the loess window for seasonal extraction (default is 10 * number of entries in eval period + 1)

Examples:

```
trendstl(/host/key,100h:now/h,10h,2h) #analyse the last 100 hours of trend data, find the anomaly rate for the last 10 hours
trendstl(/host/key,100h:now/h-10h,100h,2h,2.1,"mad") #analyse the period of 100 hours of trend data, up to 10 hours ago, find the anomaly rate
trendstl(/host/key,100d:now/d-1d,10d,1d,4,,10) #analyse 100 days of trend data up to a day ago, find the anomaly rate
trendstl(/host/key,1M:now/M-1y,1d,2h,,"stddevsamp") #analyse the previous month a year ago, find the anomaly rate

trendsum(/host/key,time period:time shift)
```

The sum of trend values within the defined time period.

Parameters:

- See [common parameters](#).

Examples:

```
trendsum(/host/key,1h:now/h) #the sum for the previous hour (e.g. 12:00-13:00)
trendsum(/host/key,1h:now/h-1h) #the sum for two hours ago (11:00-12:00)
trendsum(/host/key,1h:now/h-2h) #the sum for three hours ago (10:00-11:00)
trendsum(/host/key,1M:now/M-1y) #the sum for the previous month a year ago
```

See [all supported functions](#).

6 Mathematical functions

All functions listed here are supported in:

- [Trigger expressions](#)
- [Calculated items](#)

Mathematical functions are supported with float and integer value types, unless stated otherwise.

The functions are listed without additional information. Click on the function to see the full details.

Function	Description
abs	The absolute value of a value.
acos	The arccosine of a value as an angle, expressed in radians.
asin	The arcsine of a value as an angle, expressed in radians.
atan	The arctangent of a value as an angle, expressed in radians.

Function	Description
<code>atan2</code>	The arctangent of the ordinate (value) and abscissa coordinates specified as an angle, expressed in radians.
<code>avg</code>	The average value of the referenced item values.
<code>cbrt</code>	The cube root of a value.
<code>ceil</code>	Round the value up to the nearest greater or equal integer.
<code>cos</code>	The cosine of a value, where the value is an angle expressed in radians.
<code>cosh</code>	The hyperbolic cosine of a value.
<code>cot</code>	The cotangent of a value, where the value is an angle expressed in radians.
<code>degrees</code>	Converts a value from radians to degrees.
<code>e</code>	The Euler's number (2.718281828459045).
<code>exp</code>	The Euler's number at a power of a value.
<code>expm1</code>	The Euler's number at a power of a value minus 1.
<code>floor</code>	Round the value down to the nearest smaller or equal integer.
<code>log</code>	The natural logarithm.
<code>log10</code>	The decimal logarithm.
<code>max</code>	The highest value of the referenced item values.
<code>min</code>	The lowest value of the referenced item values.
<code>mod</code>	The division remainder.
<code>pi</code>	The Pi constant (3.14159265358979).
<code>power</code>	The power of a value.
<code>radians</code>	Converts a value from degrees to radians.
<code>rand</code>	Return a random integer value.
<code>round</code>	Round the value to decimal places.
<code>signum</code>	Returns '-1' if a value is negative, '0' if a value is zero, '1' if a value is positive.
<code>sin</code>	The sine of a value, where the value is an angle expressed in radians.
<code>sinh</code>	The hyperbolic sine of a value, where the value is an angle expressed in radians.
<code>sqrt</code>	The square root of a value.
<code>sum</code>	The sum of the referenced item values.
<code>tan</code>	The tangent of a value.
<code>truncate</code>	Truncate the value to decimal places.

Function details

Some general notes on function parameters:

- Function parameters are separated by a comma
- Expressions are accepted as parameters
- Optional function parameters (or parameter parts) are indicated by < >

`abs(value)`

The absolute value of a value.
 Supported value types: *Float, Integer, String, Text, Log*.
 For strings returns: 0 - the values are equal; 1 - the values differ.

Parameter:

- **value** - the value to check

The absolute numeric difference will be calculated, as seen with these incoming example values ('previous' and 'latest' value = absolute difference): '1' and '5' = 4; '3' and '1' = 2; '0' and '-2.5' = 2.5

Example:

```
abs(last(/host/key))>10
```

`acos(value)`

The arccosine of a value as an angle, expressed in radians.

Parameter:

- **value** - the value to check

The value must be between -1 and 1. For example, the arccosine of a value '0.5' will be '2.0943951'.

Example:

```
acos(last(/host/key))
```

asin(value)

The arcsine of a value as an angle, expressed in radians.

Parameter:

- **value** - the value to check

The value must be between -1 and 1. For example, the arcsine of a value '0.5' will be '-0.523598776'.

Example:

```
asin(last(/host/key))
```

atan(value)

The arctangent of a value as an angle, expressed in radians.

Parameter:

- **value** - the value to check

The value must be between -1 and 1. For example, the arctangent of a value '1' will be '0.785398163'.

Example:

```
atan(last(/host/key))
```

```
atan2(value,abscissa)
```

The arctangent of the ordinate (value) and abscissa coordinates specified as an angle, expressed in radians.

Parameter:

- **value** - the value to check;
- **abscissa** - the abscissa value.

For example, the arctangent of the ordinate and abscissa coordinates of a value '1' will be '2.21429744'.

Example:

```
atan(last(/host/key),2)
```

```
avg(<value1>,<value2>,...)
```

The average value of the referenced item values.

Parameter:

- **valueX** - the value returned by another function that is working with item history.

Example:

```
avg(avg(/host/key),avg(/host2/key2))
```

cbrt(value)

The cube root of a value.

Parameter:

- **value** - the value to check

For example, the cube root of '64' will be '4', of '63' will be '3.97905721'.

Example:

```
cbrt(last(/host/key))
```

ceil(value)

Round the value up to the nearest greater or equal integer.

Parameter:

- **value** - the value to check

For example, '2.4' will be rounded up to '3'. See also [floor\(\)](#).

Example:

```
ceil(last(/host/key))
```

`cos(value)`

The cosine of a value, where the value is an angle expressed in radians.

Parameter:

- **value** - the value to check

For example, the cosine of a value '1' will be '0.54030230586'.

Example:

```
cos(last(/host/key))
```

`cosh(value)`

The hyperbolic cosine of a value. Returns the value as a real number, not as scientific notation.

Parameter:

- **value** - the value to check

For example, the hyperbolic cosine of a value '1' will be '1.54308063482'.

Example:

```
cosh(last(/host/key))
```

`cot(value)`

The cotangent of a value, where the value is an angle expressed in radians.

Parameter:

- **value** - the value to check

For example, the cotangent of a value '1' will be '0.54030230586'.

Example:

```
cot(last(/host/key))
```

`degrees(value)`

Converts a value from radians to degrees.

Parameter:

- **value** - the value to check

For example, a value '1' converted to degrees will be '57.2957795'.

Example:

```
degrees(last(/host/key))
```

`e`

The Euler's number (2.718281828459045).

Example:

```
e()
```

`exp(value)`

The Euler's number at a power of a value.

Parameter:

- **value** - the value to check

For example, Euler's number at a power of a value '2' will be '7.38905609893065'.

Example:

```
exp(last(/host/key))
```

`expm1(value)`

The Euler's number at a power of a value minus 1.

Parameter:

- **value** - the value to check

For example, Euler's number at a power of a value '2' minus 1 will be '6.38905609893065'.

Example:

```
expm1(last(/host/key))
```

```
floor(value)
```

Round the value down to the nearest smaller or equal integer.

Parameter:

- **value** - the value to check

For example, '2.6' will be rounded down to '2'. See also [ceil\(\)](#).

Example:

```
floor(last(/host/key))
```

```
log(value)
```

The natural logarithm.

Parameter:

- **value** - the value to check

For example, the natural logarithm of a value '2' will be '0.69314718055994529'.

Example:

```
log(last(/host/key))
```

```
log10(value)
```

The decimal logarithm.

Parameter:

- **value** - the value to check

For example, the decimal logarithm of a value '5' will be '0.69897000433'.

Example:

```
log10(last(/host/key))
```

```
max(<value1>,<value2>,...)
```

The highest value of the referenced item values.

Parameter:

- **valueX** - the value returned by another function that is working with item history.

Example:

```
max(avg(/host/key),avg(/host2/key2))
```

```
min(<value1>,<value2>,...)
```

The lowest value of the referenced item values.

Parameter:

- **valueX** - the value returned by another function that is working with item history.

Example:

```
min(avg(/host/key),avg(/host2/key2))
```

```
mod(value,denominator)
```

The division remainder.

Parameter:

- **value** - the value to check;
- **denominator** - the division denominator.

For example, division remainder of a value '5' with division denominator '2' will be '1'.

Example:

```
mod(last(/host/key),2)
```

pi

The Pi constant (3.14159265358979).

Example:

```
pi()
```

```
power(value,power value)
```

The power of a value.

Parameter:

- **value** - the value to check;
- **power value** - the Nth power to use.

For example, the 3rd power of a value '2' will be '8'.

Example:

```
power(last(/host/key),3)
```

```
radians(value)
```

Converts a value from degrees to radians.

Parameter:

- **value** - the value to check

For example, a value '1' converted to radians will be '0.0174532925'.

Example:

```
radians(last(/host/key))
```

rand

Return a random integer value. A pseudo-random generated number using time as seed (enough for mathematical purposes, but not cryptography).

Example:

```
rand()
```

```
round(value,decimal places)
```

Round the value to decimal places.

Parameter:

- **value** - the value to check;
- **decimal places** - specify decimal places for rounding (0 is also possible).

For example, a value '2.5482' rounded to 2 decimal places will be '2.55'.

Example:

```
round(last(/host/key),2)
```

```
signum(value)
```

Returns '-1' if a value is negative, '0' if a value is zero, '1' if a value is positive.

Parameter:

- **value** - the value to check.

Example:

```
signum(last(/host/key))
```

sin(value)

The sine of a value, where the value is an angle expressed in radians.

Parameter:

- **value** - the value to check

For example, the sine of a value '1' will be '0.8414709848'.

Example:

```
sin(last(/host/key))
```

sinh(value)

The hyperbolic sine of a value, where the value is an angle expressed in radians.

Parameter:

- **value** - the value to check

For example, the hyperbolic sine of a value '1' will be '1.17520119364'.

Example:

```
sinh(last(/host/key))
```

sqrt(value)

The square root of a value.
 This function will fail with a negative value.

Parameter:

- **value** - the value to check

For example, the square root of a value '3.5' will be '1.87082869339'.

Example:

```
sqrt(last(/host/key))
```

```
sum(<value1>,<value2>,...)
```

The sum of the referenced item values.

Parameter:

- **valueX** - the value returned by another function that is working with item history.

Example:

```
sum(avg(/host/key),avg(/host2/key2))
```

tan(value)

The tangent of a value.

Parameter:

- **value** - the value to check

For example, the tangent of a value '1' will be '1.55740772465'.

Example:

```
tan(last(/host/key))
```

truncate(value,decimal places)

Truncate the value to decimal places.

Parameter:

- **value** - the value to check;
- **decimal places** - specify decimal places for truncating (0 is also possible).

For example, a value '2.5482' truncated to 2 decimal places will be '2.54'.

Example:

```
truncate(last(/host/key),2)
```

See [all supported functions](#).

7 Operator functions

All functions listed here are supported in:

- [Trigger expressions](#)
- [Calculated items](#)

The functions are listed without additional information. Click on the function to see the full details.

Function	Description
between	Check if the value belongs to the given range.
in	Check if the value is equal to at least one of the listed values.

Function details

Some general notes on function parameters:

- Function parameters are separated by a comma
- Expressions are accepted as parameters

`between(value,min,max)`

Check if the value belongs to the given range.
 Supported value types: *Integer, Float*.
 Returns: 1 - in range; 0 - otherwise.

Parameter:

- **value** - the value to check;

- **min** - the minimum value;

- **max** - the maximum value.

Example:

```
between(last(/host/key),1,10)=1 #trigger if the value is between 1 and 10
```

```
in(value,value1,value2,...valueN)
```

Check if the value is equal to at least one of the listed values.
 Supported value types: *Integer, Float, Character, Text, Log*.
 Returns: 1 - if equal; 0 - otherwise.

Parameter:

- **value** - the value to check;

- **valueX** - listed values (string values must be double-quoted).

The value is compared to the listed values as numbers, if all of these values can be converted to numeric; otherwise compared as strings.

Example:

```
in(last(/host/key),5,10)=1 #trigger if the last value is equal to 5 or 10
```

```
in("text",last(/host/key),last(/host/key,#2))=1 #trigger if "text" is equal to either of the last 2 values
```

See [all supported functions](#).

8 Predictive functions

All functions listed here are supported in:

- [Trigger expressions](#)
- [Calculated items](#)

The functions are listed without additional information. Click on the function to see the full details.

Function	Description
forecast	The future value, max, min, delta or avg of the item.
timeleft	The time in seconds needed for an item to reach the specified threshold.

Common parameters

- `/host/key` is a common mandatory first parameter for the functions referencing the host item history
- `(sec|#num)<:time shift>` is a common second parameter for the functions referencing the host item history, where:
 - **sec** - maximum **evaluation period** in seconds (time **suffixes** can be used), or
 - **#num** - maximum **evaluation range** in latest collected values (if preceded by a hash mark)
 - **time shift** (optional) allows to move the evaluation point back in time. See **more details** on specifying time shift.

Function details

Some general notes on function parameters:

- Function parameters are separated by a comma
- Optional function parameters (or parameter parts) are indicated by `< >`
- Function-specific parameters are described with each function
- `/host/key` and `(sec|#num)<:time shift>` parameters must never be quoted

`forecast(/host/key,(sec|#num)<:time shift>,time,<fit>,<mode>)`

The future value, max, min, delta or avg of the item. `
` Supported value types: *Float, Integer*.

Parameters:

- See **common parameters**; `
`
- **time** - the forecasting horizon in seconds (time suffixes can be used); negative values are supported; `
`
- **fit** (optional; must be double-quoted) - the function used to fit historical data. Supported fits: `
`*linear* - linear function (default) `
`*polynomialN* - polynomial of degree N (1 <= N <= 6) `
`*exponential* - exponential function `
`*logarithmic* - logarithmic function `
`*power* - power function `
`Note that *polynomial1* is equivalent to *linear*;
- **mode** (optional; must be double-quoted) - the demanded output. Supported modes: `
`*value* - value (default) `
`*max* - maximum `
`*min* - minimum `
`*delta* - *max-min* `
`*avg* - average `
`Note that *value* estimates the item value at the moment now + time; *max*, *min*, *delta* and *avg* investigate the item value estimate on the interval between now and now + time.

Comments:

- If the value to return is larger than 1.7976931348623158E+308 or less than -1.7976931348623158E+308, the return value is cropped to 1.7976931348623158E+308 or -1.7976931348623158E+308 correspondingly;
- Becomes unsupported only if misused in the expression (wrong item type, invalid parameters), otherwise returns -1 in case of errors;
- See also additional information on **predictive trigger functions**.

Examples:

```
forecast(/host/key,#10,1h) #forecast the item value in one hour based on the last 10 values
forecast(/host/key,1h,30m) #forecast the item value in 30 minutes based on the last hour data
forecast(/host/key,1h:now-1d,12h) #forecast the item value in 12 hours based on one hour one day ago
forecast(/host/key,1h,10m,"exponential") #forecast the item value in 10 minutes based on the last hour data
forecast(/host/key,1h,2h,"polynomial3","max") #forecast the maximum value the item can reach in the next 2 hours
forecast(/host/key,#2,-20m) #estimate the item value 20 minutes ago based on the last two values (this can be used for delta)
```

`timeleft(/host/key,(sec|#num)<:time shift>,threshold,<fit>)`

The time in seconds needed for an item to reach the specified threshold. `
` Supported value types: *Float, Integer*.

Parameters:

- See **common parameters**; `
`
- **threshold** - the value to reach (**unit suffixes** can be used);
- **fit** (optional; must be double-quoted) - see `forecast()`.

Comments:

- If the value to return is larger than 1.7976931348623158E+308, the return value is cropped to 1.7976931348623158E+308;
- Returns 1.7976931348623158E+308 if the threshold cannot be reached;
- Becomes unsupported only if misused in the expression (wrong item type, invalid parameters), otherwise returns -1 in case of errors;
- See also additional information on **predictive trigger functions**.

Examples:

```
timeleft(/host/key,#10,0) #the time until the item value reaches zero based on the last 10 values
timeleft(/host/key,1h,100) #the time until the item value reaches 100 based on the last hour data
timeleft(/host/key,1h:now-1d,100) #the time until the item value reaches 100 based on one hour one day ago
timeleft(/host/key,1h,200,"polynomial2") #the time until the item value reaches 200 based on the last hour data
```

See [all supported functions](#).

9 String functions

All functions listed here are supported in:

- [Trigger expressions](#)
- [Calculated items](#)

The functions are listed without additional information. Click on the function to see the full details.

Function	Description
ascii	The ASCII code of the leftmost character of the value.
bitlength	The length of value in bits.
bytlength	The length of value in bytes.
char	Return the character by interpreting the value as ASCII code.
concat	The string resulting from concatenating the referenced item values or constant values.
insert	Insert specified characters or spaces into the character string beginning at the specified position in the string.
jsonpath	Return the JSONPath result.
left	Return the leftmost characters of the value.
length	The length of value in characters.
ltrim	Remove specified characters from the beginning of string.
mid	Return a substring of N characters beginning at the character position specified by 'start'.
repeat	Repeat a string.
replace	Find the pattern in the value and replace with replacement.
right	Return the rightmost characters of the value.
rtrim	Remove specified characters from the end of string.
trim	Remove specified characters from the beginning and end of string.
xmlxpath	Return the XML XPath result.

Function details

Some general notes on function parameters:

- Function parameters are separated by a comma
- Expressions are accepted as parameters
- String parameters must be double-quoted; otherwise they might get misinterpreted
- Optional function parameters (or parameter parts) are indicated by < >

`ascii(value)`

The ASCII code of the leftmost character of the value.
 Supported value types: *String, Text, Log*.

Parameter:

- **value** - the value to check

For example, a value like 'Abc' will return '65' (ASCII code for 'A').

Example:

```
ascii(last(/host/key))
```

`bitlength(value)`

The length of value in bits.
 Supported value types: *String, Text, Log, Integer*.

Parameter:

- **value** - the value to check

Example:

```
bitlength(last(/host/key))
```

`bytlength(value)`

The length of value in bytes.
 Supported value types: *String, Text, Log, Integer*.

Parameter:

- **value** - the value to check

Example:

```
byteLength(last(/host/key))
```

```
char(value)
```

Return the character by interpreting the value as ASCII code.
 Supported value types: *Integer*.

Parameter:

- **value** - the value to check

The value must be in the 0-255 range. For example, a value like '65' (interpreted as ASCII code) will return 'A'.

Example:

```
char(last(/host/key))
```

```
concat(<value1>,<value2>,...)
```

The string resulting from concatenating the referenced item values or constant values.
 Supported value types: *String, Text, Log, Float, Integer*.

Parameter:

- **valueX** - the value returned by one of the history functions or a constant value (string, integer, or float number). Must contain at least two parameters.

For example, a value like 'Zab' concatenated to 'bix' (the constant string) will return 'Zabbix'.

Examples:

```
concat(last(/host/key), "bix")
```

```
concat("1 min: ", last(/host/system.cpu.load[all,avg1]), ", 15 min: ", last(/host/system.cpu.load[all,avg15]))
```

```
insert(value,start,length,replacement)
```

Insert specified characters or spaces into the character string beginning at the specified position in the string.
 Supported value types: *String, Text, Log*.

Parameters:

- **value** - the value to check;

- **start** - start position;

- **length** - positions to replace;

- **replacement** - replacement string.

For example, a value like 'Zabbix' will be replaced by 'Zabbix' if 'bb' (starting position 3, positions to replace 2) is replaced by 'b'.

Example:

```
insert(last(/host/key), 3, 2, "b")
```

```
jsonpath(value,path,<default>)
```

Return the JSONPath result.
 Supported value types: *String, Text, Log*.

Parameters:

- **value** - the value to check;

- **path** - the path (must be quoted);

- **default** - the optional fallback value if the JSONPath query returns no data. Note that on other errors failure is returned (e.g. "unsupported construct").

Example:

```
jsonpath(last(/host/proc.get[zabbix_agentd,,,summary]), "$..size")
```

```
left(value,count)
```

Return the leftmost characters of the value.
 Supported value types: *String, Text, Log*.

Parameter:

- **value** - the value to check;

- **count** - the number of characters to return.

For example, you may return 'Zab' from 'Zabbix' by specifying 3 leftmost characters to return. See also [right\(\)](#).

Example:

```
left(last(/host/key),3) #return three leftmost characters
```

```
length(value)
```

The length of value in characters.
 Supported value types: *String, Text, Log*.

Parameter:

- **value** - the value to check.

Examples:

```
length(last(/host/key)) #the length of the latest value
```

```
length(last(/host/key,#3)) #the length of the third most recent value
```

```
length(last(/host/key,#1:now-1d)) #the length of the most recent value one day ago
```

```
ltrim(value,<chars>)
```

Remove specified characters from the beginning of string.
 Supported value types: *String, Text, Log*.

Parameter:

- **value** - the value to check;

- **chars** (optional) - specify the characters to remove.

Whitespace is left-trimmed by default (if no optional characters are specified). See also: [rtrim\(\)](#), [trim\(\)](#).

Examples:

```
ltrim(last(/host/key)) #remove whitespace from the beginning of string
```

```
ltrim(last(/host/key),"Z") #remove any 'Z' from the beginning of string
```

```
ltrim(last(/host/key)," Z") #remove any space and 'Z' from the beginning of string
```

```
mid(value,start,length)
```

Return a substring of N characters beginning at the character position specified by 'start'.
 Supported value types: *String, Text, Log*.

Parameter:

- **value** - the value to check;

- **start** - start position of the substring;

- **length** - positions to return in substring.

For example, it is possible return 'abbi' from a value like 'Zabbix' if starting position is 2, and positions to return is 4.

Example:

```
mid(last(/host/key),2,4)="abbi"
```

```
repeat(value,count)
```

Repeat a string.
 Supported value types: *String, Text, Log*.

Parameter:

- **value** - the value to check;

- **count** - the number of times to repeat.

Example:

```
repeat(last(/host/key),2) #repeat the value two times
```

```
replace(value,pattern,replacement)
```

Find the pattern in the value and replace with replacement. All occurrences of the pattern will be replaced.
 Supported value types: *String, Text, Log*.

Parameter:

- **value** - the value to check;

- **pattern** - the pattern to find;

- **replacement** - the string to replace the pattern with.

Example:

`replace(last(/host/key),"ibb","abb")` - replace all 'ibb' with 'abb'

`right(value,count)`

Return the rightmost characters of the value.
 Supported value types: *String, Text, Log*.

Parameter:

- **value** - the value to check;

- **count** - the number of characters to return.

For example, you may return 'bix' from 'Zabbix' by specifying 3 rightmost characters to return. See also [left\(\)](#).

Example:

```
right(last(/host/key),3) #return three rightmost characters
```

```
rtrim(value,<chars>)
```

Remove specified characters from the end of string.
 Supported value types: *String, Text, Log*.

Parameter:

- **value** - the value to check;

- **chars** (optional) - specify the characters to remove.

Whitespace is right-trimmed by default (if no optional characters are specified). See also: [ltrim\(\)](#), [trim\(\)](#).

Examples:

```
rtrim(last(/host/key)) #remove whitespace from the end of string
```

```
rtrim(last(/host/key),"x") #remove any 'x' from the end of string
```

```
rtrim(last(/host/key),"x ") #remove any 'x' and space from the end of string
```

```
trim(value,<chars>)
```

Remove specified characters from the beginning and end of string.
 Supported value types: *String, Text, Log*.

Parameter:

- **value** - the value to check;

- **chars** (optional) - specify the characters to remove.

Whitespace is trimmed from both sides by default (if no optional characters are specified). See also: [ltrim\(\)](#), [rtrim\(\)](#).

Examples:

```
trim(last(/host/key)) - remove whitespace from the beginning and end of string
```

```
trim(last(/host/key),"_") - remove '_' from the beginning and end of string
```

```
xmlxpath(value,path,<default>)
```

Return the XML XPath result.
 Supported value types: *String, Text, Log*.

Parameters:

- **value** - the value to check;

- **path** - the path (must be quoted);

- **default** - the optional fallback value if the XML XPath query returns an empty nodeset. It will not be returned if the empty result is not a nodeset (i.e., empty string). On other errors failure is returned (e.g. "invalid expression").

Example:

```
xmlxpath(last(/host/xml_result),"/response/error/status")
```

See [all supported functions](#).

6 Macros

It is possible to use out-of-the-box [Supported macros](#) and [User macros supported by location](#).

1 Supported macros

Overview

This page contains a complete list of built-in macros supported by Zabbix, grouped by application area.

Note:

To view all macros supported in a specific location, paste the location name (for example, "map URL") into your browser's search box (accessible by pressing CTRL+F) and search for *next*.

Note:

To customize macro values (for example, shorten or extract specific substrings), you can use **macro functions**.

Actions

Macro	Supported in	Description
{ACTION.ID}	→ Trigger-based notifications and commands → Problem update notifications and commands → Service-based notifications and commands → Service update notifications and commands → Discovery notifications and commands → Autoregistration notifications and commands → Internal notifications	<i>Numeric ID of the triggered action.</i>
{ACTION.NAME}	→ Trigger-based notifications and commands → Problem update notifications and commands → Service-based notifications and commands → Service update notifications and commands → Discovery notifications and commands → Autoregistration notifications and commands → Internal notifications	<i>Name of the triggered action.</i>
{ALERT.MESSAGE}	→ Alert script parameters → Webhook parameters	<i>'Default message' value from action configuration.</i>
{ALERT.SENDTO}	→ Alert script parameters → Webhook parameters	<i>'Send to' value from user media configuration.</i>
{ALERT.SUBJECT}	→ Alert script parameters → Webhook parameters	<i>'Default subject' value from action configuration.</i>
{ESC.HISTORY}	→ Trigger-based notifications and commands → Problem update notifications and commands → Service-based notifications and commands → Service update notifications and commands → Internal notifications	<i>Escalation history. Log of previously sent messages. Shows previously sent notifications, on which escalation step they were sent and their status (sent, in progress or failed).</i>

Date and time

Macro	Supported in	Description
{DATE}	→ Trigger-based notifications and commands → Problem update notifications and commands → Service-based notifications and commands → Service update notifications and commands → Discovery notifications and commands → Autoregistration notifications and commands → Internal notifications → Manual event action scripts	<i>Current date in yyyy.mm.dd. format.</i>

Macro	Supported in	Description
{TIME}	<ul style="list-style-type: none"> → Trigger-based notifications and commands → Problem update notifications and commands → Service-based notifications and commands → Service update notifications and commands → Discovery notifications and commands → Autoregistration notifications and commands → Internal notifications → Trigger event names → Manual event action scripts 	<i>Current time in hh:mm:ss.</i>
{TIMESTAMP}	<ul style="list-style-type: none"> → Trigger-based notifications and commands → Problem update notifications and commands → Service-based notifications and commands → Service update notifications and commands → Discovery notifications and commands → Autoregistration notifications and commands → Internal notifications → Trigger event names → Manual event action scripts 	<i>Current time in Unix timestamp format.</i>

Discovery

Macro	Supported in	Description
{DISCOVERY.DEVICE.IPADDRESS}	Discovery notifications and commands	<i>IP address of the discovered device.</i> Available always, does not depend on host being added.
{DISCOVERY.DEVICE.DNS}	Discovery notifications and commands	<i>DNS name of the discovered device.</i> Available always, does not depend on host being added.
{DISCOVERY.DEVICE.STATUS}	Discovery notifications and commands	<i>Status of the discovered device: can be either UP or DOWN.</i>
{DISCOVERY.DEVICE.DURATION}	Discovery notifications and commands	<i>Time since the last change of discovery status for a particular device, with precision down to a second.</i> For example: 1h 29m 01s. For devices with status DOWN, this is the period of their downtime.
{DISCOVERY.RULE.NAME}	Discovery notifications and commands	<i>Name of the discovery rule that discovered the presence or absence of the device or service.</i>
{DISCOVERY.SERVICE.NAME}	Discovery notifications and commands	<i>Name of the service that was discovered.</i> For example: HTTP.
{DISCOVERY.SERVICE.PORT}	Discovery notifications and commands	<i>Port of the service that was discovered.</i> For example: 80.
{DISCOVERY.SERVICE.STATUS}	Discovery notifications and commands	<i>Status of the discovered service: can be either UP or DOWN.</i>
{DISCOVERY.SERVICE.DURATION}	Discovery notifications and commands	<i>Time since the last change of discovery status for a particular service, with precision down to a second.</i> For example: 1h 29m 01s. For services with status DOWN, this is the period of their downtime.

Events

Macro	Supported in	Description
{EVENT.ACK.STATUS}	<ul style="list-style-type: none"> → Trigger-based notifications and commands → Problem update notifications and commands → Manual event action scripts 	<i>Acknowledgment status of the event (Yes/No).</i>

Macro	Supported in	Description
{EVENT.AGE}	<ul style="list-style-type: none"> → Trigger-based notifications and commands → Problem update notifications and commands → Service-based notifications and commands → Service update notifications and commands → Service recovery notifications and commands → Discovery notifications and commands → Autoregistration notifications and commands → Internal notifications → Manual event action scripts 	<p><i>Age of the event that triggered an action, with precision down to a second.</i></p> <p>Useful in escalated messages.</p>
{EVENT.DATE}	<ul style="list-style-type: none"> → Trigger-based notifications and commands → Problem update notifications and commands → Service-based notifications and commands → Service update notifications and commands → Service recovery notifications and commands → Discovery notifications and commands → Autoregistration notifications and commands → Internal notifications → Manual event action scripts 	<p><i>Date of the event that triggered an action.</i></p>
{EVENT.DURATION}	<ul style="list-style-type: none"> → Trigger-based notifications and commands → Problem update notifications and commands → Service-based notifications and commands → Service update notifications and commands → Service recovery notifications and commands → Internal notifications → Manual event action scripts 	<p><i>Duration of the event (time difference between problem and recovery events), with precision down to a second.</i></p> <p>Useful in problem recovery messages.</p>
{EVENT.ID}	<ul style="list-style-type: none"> → Trigger-based notifications and commands → Problem update notifications and commands → Service-based notifications and commands → Service update notifications and commands → Service recovery notifications and commands → Discovery notifications and commands → Autoregistration notifications and commands → Internal notifications → Trigger URLs → Manual event action scripts 	<p><i>Numeric ID of the event that triggered an action.</i></p>
{EVENT.NAME}	<ul style="list-style-type: none"> → Trigger-based notifications and commands → Problem update notifications and commands → Service-based notifications and commands → Service update notifications and commands → Service recovery notifications and commands → Internal notifications → Manual event action scripts 	<p><i>Name of the problem event that triggered an action.</i></p>
{EVENT.SEVERITY}	<ul style="list-style-type: none"> → Trigger-based notifications and commands → Problem update notifications and commands → Service-based notifications and commands → Service update notifications and commands → Service recovery notifications and commands → Manual event action scripts 	<p><i>Numeric value of the event severity. Possible values: 0 - Not classified, 1 - Information, 2 - Warning, 3 - Average, 4 - High, 5 - Disaster.</i></p>
{EVENT.OBJECT}	<ul style="list-style-type: none"> → Trigger-based notifications and commands → Problem update notifications and commands → Service-based notifications and commands → Service update notifications and commands → Service recovery notifications and commands → Discovery notifications and commands → Autoregistration notifications and commands → Internal notifications → Manual event action scripts 	<p><i>Numeric value of the event object. Possible values: 0 - Trigger, 1 - Discovered host, 2 - Discovered service, 3 - Autoregistration, 4 - Item, 5 - Low-level discovery rule.</i></p>
{EVENT.OPDATA}	<ul style="list-style-type: none"> → Trigger-based notifications and commands → Problem update notifications and commands → Manual event action scripts 	<p><i>Operational data of the underlying trigger of a problem.</i></p>

Macro	Supported in	Description
{EVENT.RECOVERY.DATE}	<ul style="list-style-type: none"> → Problem recovery notifications and commands → Problem update notifications and commands (if recovery took place) → Service recovery notifications and commands → Manual event action scripts (if recovery took place) 	<i>Date of the recovery event.</i>
{EVENT.RECOVERY.ID}	<ul style="list-style-type: none"> → Problem recovery notifications and commands → Problem update notifications and commands (if recovery took place) → Service recovery notifications and commands → Manual event action scripts (if recovery took place) 	<i>Numeric ID of the recovery event.</i>
{EVENT.RECOVERY.NAME}	<ul style="list-style-type: none"> → Problem recovery notifications and commands → Problem update notifications and commands (if recovery took place) → Service recovery notifications and commands → Manual event action scripts (if recovery took place) 	<i>Name of the recovery event.</i>
{EVENT.RECOVERY.STATUS}	<ul style="list-style-type: none"> → Problem recovery notifications and commands → Problem update notifications and commands (if recovery took place) → Service recovery notifications and commands → Manual event action scripts (if recovery took place) 	<i>Verbal value of the recovery event.</i>
{EVENT.RECOVERY.TAGS}	<ul style="list-style-type: none"> → Problem recovery notifications and commands → Problem update notifications and commands (if recovery took place) → Service recovery notifications and commands → Internal notifications → Manual event action scripts (if recovery took place) 	<i>A comma separated list of recovery event tags. Expanded to an empty string if no tags exist.</i>
{EVENT.RECOVERY.TAGS.JSON}	<ul style="list-style-type: none"> → Problem recovery notifications and commands → Problem update notifications and commands (if recovery took place) → Service recovery notifications and commands → Internal notifications → Manual event action scripts (if recovery took place) 	<i>A JSON array containing event tag objects. Expanded to an empty array if no tags exist.</i>
{EVENT.RECOVERY.TIME}	<ul style="list-style-type: none"> → Problem recovery notifications and commands → Problem update notifications and commands (if recovery took place) → Service recovery notifications and commands → Manual event action scripts (if recovery took place) 	<i>Time of the recovery event.</i>
{EVENT.RECOVERY.TIMESTAMP}	<ul style="list-style-type: none"> → Problem recovery notifications and commands → Problem update notifications and commands (if recovery took place) → Service recovery notifications and commands → Manual event action scripts (if recovery took place) 	<i>Unix timestamp of the recovery event.</i>
{EVENT.RECOVERY.VALUE}	<ul style="list-style-type: none"> → Problem recovery notifications and commands → Problem update notifications and commands (if recovery took place) → Service recovery notifications and commands → Manual event action scripts (if recovery took place) 	<i>Numeric value of the recovery event.</i>
{EVENT.SEVERITY}	<ul style="list-style-type: none"> → Trigger-based notifications and commands → Problem update notifications and commands → Service-based notifications and commands → Service update notifications and commands → Service recovery notifications and commands → Manual event action scripts 	<i>Name of the event severity.</i>
{EVENT.SOURCE}	<ul style="list-style-type: none"> → Trigger-based notifications and commands → Problem update notifications and commands → Service-based notifications and commands → Service update notifications and commands → Service recovery notifications and commands → Discovery notifications and commands → Autoregistration notifications and commands → Internal notifications → Manual event action scripts 	<i>Numeric value of the event source. Possible values: 0 - Trigger, 1 - Discovery, 2 - Autoregistration, 3 - Internal, 4 - Service.</i>

Macro	Supported in	Description
{EVENT.STATUS}	<ul style="list-style-type: none"> → Trigger-based notifications and commands → Problem update notifications and commands → Service-based notifications and commands → Service update notifications and commands → Service recovery notifications and commands → Internal notifications → Manual event action scripts 	<i>Verbal value of the event that triggered an action.</i>
{EVENT.TAGS}	<ul style="list-style-type: none"> → Trigger-based notifications and commands → Problem update notifications and commands → Service-based notifications and commands → Service update notifications and commands → Service recovery notifications and commands → Internal notifications → Manual event action scripts 	<i>A comma separated list of event tags. Expanded to an empty string if no tags exist.</i>
{EVENT.TAGSJSON}	<ul style="list-style-type: none"> → Trigger-based notifications and commands → Problem update notifications and commands → Service-based notifications and commands → Service update notifications and commands → Service recovery notifications and commands → Internal notifications → Manual event action scripts 	<i>A JSON array containing event tag objects. Expanded to an empty array if no tags exist.</i>
{EVENT.TAGS.<tag name>}	<ul style="list-style-type: none"> → Trigger-based notifications and commands → Problem update notifications and commands → Service-based notifications and commands → Service update notifications and commands → Service recovery notifications and commands → Internal notifications → Webhook media type URL names and URLs → Manual event action scripts 	<i>Event tag value referenced by the tag name. A tag name containing non-alphanumeric characters (including non-English multibyte-UTF characters) should be double quoted. Quotes and backslashes inside a quoted tag name must be escaped with a backslash.</i>
{EVENT.TIME}	<ul style="list-style-type: none"> → Trigger-based notifications and commands → Problem update notifications and commands → Service-based notifications and commands → Service update notifications and commands → Service recovery notifications and commands → Discovery notifications and commands → Autoregistration notifications and commands → Internal notifications → Manual event action scripts 	<i>Time of the event that triggered an action.</i>
{EVENT.TIMESTAMP}	<ul style="list-style-type: none"> → Trigger-based notifications and commands → Problem update notifications and commands → Service-based notifications and commands → Service update notifications and commands → Service recovery notifications and commands → Discovery notifications and commands → Autoregistration notifications and commands → Internal notifications → Manual event action scripts 	<i>Unix timestamp of the event that triggered an action.</i>
{EVENT.UPDATE.ACTION}	<ul style="list-style-type: none"> → Problem update notifications and commands 	<p><i>Human-readable name of the action(s) performed during problem update.</i></p> <p><i>Resolves to the following values: acknowledged, commented, changed severity from (original severity) to (updated severity) and closed (depending on how many actions are performed in one update).</i></p>

Macro	Supported in	Description
{EVENT.UPDATE.ACK.JSON}	Problem update notifications and commands	A <i>JSON</i> array containing details of the action(s) performed during problem update . Possible JSON property values: - true (for acknowledge, unacknowledge, close, unsuppress, cause, and symptom properties); - <message string> (for message property); - timestamp (for suppress_until and timestamp properties) or 0 (for suppress_until property if suppressed indefinitely); - 0, 1, 2, 3, 4, 5 (for old and new severity properties). For example: { "acknowledge": true, "message": "Monthly maintenance.", "severity": { "old": 2, "new": 1 }, "suppress_until": 0 } Date of event update (acknowledgment, etc). Deprecated name: {ACK.DATE}
{EVENT.UPDATE.DATE}	Problem update notifications and commands → Service update notifications and commands	Deprecated name: {ACK.DATE}
{EVENT.UPDATE.HISTORY}	Trigger-based notifications and commands → Problem update notifications and commands → Manual event action scripts	Log of problem updates (acknowledgments, etc). Deprecated name: {EVENT.ACK.HISTORY}
{EVENT.UPDATE.MESSAGE}	Problem update notifications and commands	Problem update message. Deprecated name: {ACK.MESSAGE}
{EVENT.UPDATE.NEWSEVERITY}	Problem update notifications and commands	Numeric value of the new event severity set during problem update operation.
{EVENT.UPDATE.SEVERITY}	Problem update notifications and commands	Name of the new event severity set during problem update operation.
{EVENT.UPDATE.STATUS}	Trigger-based notifications and commands → Problem update notifications and commands → Service update notifications and commands → Manual event action scripts	Numeric value of the problem update status. Possible values: 0 - Webhook was called because of problem/recovery event, 1 - Update operation.
{EVENT.UPDATE.TIME}	Problem update notifications and commands → Service update notifications and commands	Time of event update (acknowledgment, etc). Deprecated name: {ACK.TIME}
{EVENT.UPDATE.TIMESTAMP}	Problem update notifications and commands → Service update notifications and commands	Unix timestamp of event update (acknowledgment, etc).
{EVENT.VALUE}	Trigger-based notifications and commands → Problem update notifications and commands → Service-based notifications and commands → Service update notifications and commands → Service recovery notifications and commands → Internal notifications → Manual event action scripts	Numeric value of the event that triggered an action (1 for problem, 0 for recovering).

Cause and symptom events

{EVENT.CAUSE.*} macros are used in the context of a symptom event, for example, in notifications; they return information about the cause event.

The {EVENT.SYMPATOMS} macro is used in the context of the cause event and returns information about symptom events.

Macro	Supported in	Description
{EVENT.CAUSE.ACK.STATUS}	Trigger-based notifications and commands → Problem update notifications and commands → Manual event action scripts	Acknowledgment status of the cause event (Yes/No).
{EVENT.CAUSE.AGE}	Trigger-based notifications and commands → Problem update notifications and commands → Manual event action scripts	Age of the cause event, with precision down to a second. Useful in escalated messages.
{EVENT.CAUSE.DATE}	Trigger-based notifications and commands → Problem update notifications and commands → Manual event action scripts	Date of the cause event.

Macro	Supported in	Description
{EVENT.CAUSE.DURATION}	Trigger-based notifications and commands → Problem update notifications and commands → Manual event action scripts	<i>Duration of the cause event (time difference between problem and recovery events), with precision down to a second. Useful in problem recovery messages.</i>
{EVENT.CAUSE.ID}	Trigger-based notifications and commands → Problem update notifications and commands → Manual event action scripts	<i>Numeric ID of the cause event .</i>
{EVENT.CAUSE.NAME}	Trigger-based notifications and commands → Problem update notifications and commands → Manual event action scripts	<i>Name of the cause problem event.</i>
{EVENT.CAUSE.SEVERITY}	Trigger-based notifications and commands → Problem update notifications and commands → Manual event action scripts	<i>Numeric value of the cause event severity. Possible values: 0 - Not classified, 1 - Information, 2 - Warning, 3 - Average, 4 - High, 5 - Disaster.</i>
{EVENT.CAUSE.OBJECT}	Trigger-based notifications and commands → Problem update notifications and commands → Manual event action scripts	<i>Numeric value of the cause event object. Possible values: 0 - Trigger, 1 - Discovered host, 2 - Discovered service, 3 - Autoregistration, 4 - Item, 5 - Low-level discovery rule.</i>
{EVENT.CAUSE.OPDATA}	Trigger-based notifications and commands → Problem update notifications and commands → Manual event action scripts	<i>Operational data of the underlying trigger of the cause problem.</i>
{EVENT.CAUSE.SEVERITY}	Trigger-based notifications and commands → Problem update notifications and commands → Manual event action scripts	<i>Name of the cause event severity.</i>
{EVENT.CAUSE.SOURCE}	Trigger-based notifications and commands → Problem update notifications and commands → Manual event action scripts	<i>Numeric value of the cause event source. Possible values: 0 - Trigger, 1 - Discovery, 2 - Autoregistration, 3 - Internal.</i>
{EVENT.CAUSE.STATUS}	Trigger-based notifications and commands → Problem update notifications and commands → Manual event action scripts	<i>Verbal value of the cause event.</i>
{EVENT.CAUSE.TAGS}	Trigger-based notifications and commands → Problem update notifications and commands → Manual event action scripts	<i>A comma separated list of cause event tags. Expanded to an empty string if no tags exist.</i>
{EVENT.CAUSE.TAGS[JSON]}	Trigger-based notifications and commands → Problem update notifications and commands → Manual event action scripts	<i>A JSON array containing cause event tag objects. Expanded to an empty array if no tags exist.</i>
{EVENT.CAUSE.TAGS[tag name>]}	Trigger-based notifications and commands → Problem update notifications and commands → Manual event action scripts	<i>Cause event tag value referenced by the tag name. A tag name containing non-alphanumeric characters (including non-English multibyte-UTF characters) should be double quoted. Quotes and backslashes inside a quoted tag name must be escaped with a backslash.</i>
{EVENT.CAUSE.TIME}	Trigger-based notifications and commands → Problem update notifications and commands → Manual event action scripts	<i>Time of the cause event.</i>
{EVENT.CAUSE.TIME[GMT]}	Trigger-based notifications and commands → Problem update notifications and commands → Manual event action scripts	<i>Unix timestamp of the cause event.</i>
{EVENT.CAUSE.UPDATEHISTORY}	Trigger-based notifications and commands → Problem update notifications and commands → Manual event action scripts	<i>Log of cause problem updates (acknowledgments, etc).</i>
{EVENT.CAUSE.VALUE}	Trigger-based notifications and commands → Problem update notifications and commands → Manual event action scripts	<i>Numeric value of the cause event (1 for problem, 0 for recovering).</i>
{EVENT.SYMPTOMS}	Trigger-based notifications and commands → Problem update notifications and commands → Manual event action scripts	<i>The list of symptom events. Includes the following details: host name, event name, severity, age, service tags and values.</i>

Macro	Supported in	Description
{FUNCTION.VALUE}	<ul style="list-style-type: none"> → Trigger-based notifications and commands → Problem update notifications and commands → Manual event action scripts → Event names 	<p><i>Results of the Nth item-based function in the trigger expression at the time of the event.</i></p> <p>Only functions with <i>/host/key</i> as the first parameter are counted.</p> <p>This macro may be used with a numeric index e.g. {FUNCTION.VALUE<1-9>} to point to the first, second, third, etc. function in a trigger expression. See indexed macros.</p>
{FUNCTION.RECOVERY.VALUE}	<ul style="list-style-type: none"> → Trigger-based recovery notifications and commands → Problem update notifications and commands → Manual event action scripts → Event names 	<p><i>Results of the Nth item-based function in the recovery expression at the time of the event.</i></p> <p>Only functions with <i>/host/key</i> as the first parameter are counted.</p> <p>This macro may be used with a numeric index e.g. {FUNCTION.RECOVERY.VALUE<1-9>} to point to the first, second, third, etc. function in a trigger expression. See indexed macros.</p>

Hosts

Macro	Supported in	Description
{HOST.CONN}	<ul style="list-style-type: none"> → Trigger-based notifications and commands → Problem update notifications and commands → Internal notifications → Map element labels, map URL names and values → Item key parameters¹ → Host interface IP/DNS → Trapper item "Allowed hosts" field → Database monitoring additional parameters → SSH and Telnet scripts → JMX item endpoint field → Web monitoring⁴ → Low-level discovery rule filter regular expressions → URL field of dynamic URL dashboard widget → Trigger names, event names, operational data and descriptions → Trigger URLs → Tag names and values → Script-type item and Browser-type item, item prototype and discovery rule parameter names and values → HTTP agent type item, item prototype and discovery rule fields: URL, Query fields, Request body, Headers, SSL certificate file, SSL key file, Allowed hosts → Manual host action scripts (including confirmation text) → Manual event action scripts (including confirmation text) → <i>Description</i> parameter in <i>Item value</i> and <i>Gauge</i> widget → Primary/Secondary label <i>Text</i> parameter in <i>Honeycomb</i> widget → Column of data type <i>Text</i> in <i>Top hosts</i> widget 	<p><i>Host IP address or DNS name, depending on host settings².</i></p> <p>This macro may be used with a numeric index as {HOST.CONN<1-9>} to point to the first, second, third, etc. host in a trigger expression. See indexed macros.</p>

Macro	Supported in	Description
{HOST.DESCRPTION}	<ul style="list-style-type: none"> → Trigger-based notifications and commands → Problem update notifications and commands → Internal notifications → Map element labels → Manual event action <i>scripts</i> → <i>Description</i> parameter in <i>Item value</i> and <i>Gauge</i> widget → Primary/Secondary label <i>Text</i> parameter in <i>Honeycomb</i> widget → Column of data type <i>Text</i> in <i>Top hosts</i> widget 	<p><i>Host description</i>.</p> <p>This macro may be used with a numeric index e.g. {HOST.DESCRPTION<1-9>} to point to the first, second, third, etc. host in a trigger expression. See <i>indexed macros</i>.</p>
{HOST.DNS}	<ul style="list-style-type: none"> → Trigger-based notifications and commands → Problem update notifications and commands → Internal notifications → Map element labels, map URL names and values → Item key parameters¹ → Host interface IP/DNS → Trapper item "Allowed hosts" field → Database monitoring additional parameters → SSH and Telnet scripts → JMX item endpoint field → Web monitoring⁴ → Low-level discovery rule filter regular expressions → URL field of dynamic URL dashboard widget → Trigger names, event names, operational data and descriptions → Trigger URLs → <i>Tag names and values</i> → Script-type item and Browser-type item, item prototype and discovery rule parameter names and values → HTTP agent type item, item prototype and discovery rule fields: URL, Query fields, Request body, Headers, SSL certificate file, SSL key file, Allowed hosts → Manual host action <i>scripts</i> (including confirmation text) → Manual event action <i>scripts</i> (including confirmation text) → <i>Description</i> parameter in <i>Item value</i> and <i>Gauge</i> widget → Primary/Secondary label <i>Text</i> parameter in <i>Honeycomb</i> widget → Column of data type <i>Text</i> in <i>Top hosts</i> widget 	<p><i>Host DNS name</i>².</p> <p>This macro may be used with a numeric index e.g. {HOST.DNS<1-9>} to point to the first, second, third, etc. host in a trigger expression. See <i>indexed macros</i>.</p>

Macro	Supported in	Description
{HOST.HOST}	<ul style="list-style-type: none"> → Trigger-based notifications and commands → Problem update notifications and commands → Autoregistration notifications and commands → Internal notifications → Item key parameters → Map element labels, map URL names and values → Host interface IP/DNS → Trapper item "Allowed hosts" field → Database monitoring additional parameters → SSH and Telnet scripts → JMX item endpoint field → Web monitoring⁴ → Low-level discovery rule filter regular expressions → URL field of dynamic URL dashboard widget → Trigger names, event names, operational data and descriptions → Trigger URLs → Tag names and values → Script-type item and Browser-type item, item prototype and discovery rule parameter names and values → HTTP agent type item, item prototype and discovery rule fields: URL, Query fields, Request body, Headers, SSL certificate file, SSL key file, Allowed hosts → Manual host action scripts (including confirmation text) → Manual event action scripts (including confirmation text) → <i>Description</i> parameter in <i>Item value</i> and <i>Gauge</i> widget → Primary/Secondary label <i>Text</i> parameter in <i>Honeycomb</i> widget → Column of data type <i>Text</i> in <i>Top hosts</i> widget 	<p><i>Host name.</i></p> <p>This macro may be used with a numeric index e.g. {HOST.HOST<1-9>} to point to the first, second, third, etc. host in a trigger expression. See indexed macros.</p> <p>{HOSTNAME<1-9>} is deprecated.</p> <p>Macro functions are not supported for this macro if it is used as a placeholder in the first parameter of a history function, for example, <code>last (/ {HOST.HOST} / {ITEM.KEY})</code>.</p>
{HOST.ID}	<ul style="list-style-type: none"> → Trigger-based notifications and commands → Problem update notifications and commands → Internal notifications → Map element labels, map URL names and values → URL field of dynamic URL dashboard widget → Trigger URLs → Tag names and values → Manual event action scripts → Manual host action scripts (only for type URL, including confirmation text) → Manual event action scripts (only for type URL, including confirmation text) → <i>Description</i> parameter in <i>Item value</i> and <i>Gauge</i> widget → Primary/Secondary label <i>Text</i> parameter in <i>Honeycomb</i> widget → Column of data type <i>Text</i> in <i>Top hosts</i> widget 	<p><i>Host ID.</i></p> <p>May be used with a numeric index as {HOST.ID<1-9>} to point to the first, second, third, etc. host in a trigger expression. See indexed macros.</p>

Macro	Supported in	Description
{HOST.IP}	<ul style="list-style-type: none"> → Trigger-based notifications and commands → Problem update notifications and commands → Autoregistration notifications and commands → Internal notifications → Map element labels, map URL names and values → Item key parameters¹ → Host interface IP/DNS → Trapper item "Allowed hosts" field → Database monitoring additional parameters → SSH and Telnet scripts → JMX item endpoint field → Web monitoring⁴ → Low-level discovery rule filter regular expressions → URL field of dynamic URL dashboard widget → Trigger names, event names, operational data and descriptions → Trigger URLs → Tag names and values → Script-type item and Browser-type item, item prototype and discovery rule parameter names and values → HTTP agent type item, item prototype and discovery rule fields: URL, Query fields, Request body, Headers, SSL certificate file, SSL key file, Allowed hosts → Manual host action scripts (including confirmation text) → Manual event action scripts (including confirmation text) → <i>Description</i> parameter in <i>Item value</i> and <i>Gauge</i> widget → Primary/Secondary label <i>Text</i> parameter in <i>Honeycomb</i> widget → Column of data type <i>Text</i> in <i>Top hosts</i> widget 	<p><i>Host IP address</i>².</p> <p>This macro may be used with a numeric index e.g. {HOST.IP<1-9>} to point to the first, second, third, etc. host in a trigger expression. See indexed macros.</p> <p>{IPADDRESS<1-9>} is deprecated.</p>
{HOST.METADATA}	Autoregistration notifications and commands	<p><i>Host metadata.</i></p> <p>Used only for active agent autoregistration.</p>

Macro	Supported in	Description
{HOST.NAME}	<ul style="list-style-type: none"> → Trigger-based notifications and commands → Problem update notifications and commands → Internal notifications → Map element labels, map URL names and values → Item key parameters → Host interface IP/DNS → Trapper item "Allowed hosts" field → Database monitoring additional parameters → SSH and Telnet scripts → Web monitoring⁴ → Low-level discovery rule filter regular expressions → URL field of dynamic URL dashboard widget → Trigger names, event names, operational data and descriptions → Trigger URLs → Tag names and values → Script-type item and Browser-type item, item prototype and discovery rule parameter names and values → HTTP agent type item, item prototype and discovery rule fields: URL, Query fields, Request body, Headers, SSL certificate file, SSL key file, Allowed hosts → Manual host action scripts (including confirmation text) → Manual event action scripts (including confirmation text) → <i>Description</i> parameter in <i>Item value</i> and <i>Gauge</i> widget → Primary/Secondary label <i>Text</i> parameter in <i>Honeycomb</i> widget → Column of data type <i>Text</i> in <i>Top hosts</i> widget 	<p><i>Visible host name.</i></p> <p>This macro may be used with a numeric index e.g. {HOST.NAME<1-9>} to point to the first, second, third, etc. host in a trigger expression. See indexed macros.</p>

Macro	Supported in	Description
{HOST.PORT}	<ul style="list-style-type: none"> → Trigger-based notifications and commands → Problem update notifications and commands → Autoregistration notifications and commands → Internal notifications → Map element labels, map URL names and values → Item key parameters¹ → Database monitoring additional parameters → SSH and Telnet scripts → JMX item endpoint field → Web monitoring⁴ → Low-level discovery rule filter regular expressions → URL field of dynamic URL dashboard widget → Trigger names, event names, operational data and descriptions → Trigger URLs → Tag names and values → Script-type item and Browser-type item, item prototype and discovery rule parameter names and values → HTTP agent type item, item prototype and discovery rule fields: URL, Query fields, Request body, Headers, SSL certificate file, SSL key file → Manual host action scripts (including confirmation text) → Manual event action scripts (including confirmation text) → <i>Description</i> parameter in <i>Item value</i> and <i>Gauge</i> widget → Primary/Secondary label <i>Text</i> parameter in <i>Honeycomb</i> widget → Column of data type <i>Text</i> in <i>Top hosts</i> widget 	<p><i>Host (agent) port</i>².</p> <p>This macro may be used with a numeric index e.g. {HOST.PORT<1-9>} to point to the first, second, third, etc. host in a trigger expression. See indexed macros.</p>
{HOST.TARGET.CONN}	<ul style="list-style-type: none"> → Trigger-based commands → Problem update commands → Discovery commands → Autoregistration commands 	<i>IP address or DNS name of the target host, depending on host settings.</i>
{HOST.TARGET.DNS}	<ul style="list-style-type: none"> → Trigger-based commands → Problem update commands → Discovery commands → Autoregistration commands 	<i>DNS name of the target host.</i>
{HOST.TARGET.HOST}	<ul style="list-style-type: none"> → Trigger-based commands → Problem update commands → Discovery commands → Autoregistration commands 	<i>Technical name of the target host.</i>
{HOST.TARGET.IP}	<ul style="list-style-type: none"> → Trigger-based commands → Problem update commands → Discovery commands → Autoregistration commands 	<i>IP address of the target host.</i>
{HOST.TARGET.NAME}	<ul style="list-style-type: none"> → Trigger-based commands → Problem update commands → Discovery commands → Autoregistration commands 	<i>Visible name of the target host.</i>

See also: [Host inventory](#)

Host groups

Macro	Supported in	Description
{HOSTGROUP.ID}	Map element labels, map URL names and values	<i>Host group ID.</i>

Macro	Supported in	Description
{INVENTORY.ALIAS}	<ul style="list-style-type: none"> Trigger-based notifications and commands → Problem update notifications and commands → Internal notifications → Tag names and values → Map element labels, map URL names and values → Script-type items and Browser-type items⁶ → Manual host action scripts⁶ → Manual event action scripts → <i>Description</i> parameter in <i>Item value</i> and <i>Gauge</i> widget → Primary/Secondary label <i>Text</i> parameter in <i>Honeycomb</i> widget → Column of data type <i>Text</i> in <i>Top hosts</i> widget 	<p><i>Alias field in host inventory.</i></p> <p>This macro may be used with a numeric index e.g. {INVENTORY.ALIAS<1-9>} to point to the first, second, third, etc. host in a trigger expression. See indexed macros.</p>
{INVENTORY.ASSET.TAG}	<ul style="list-style-type: none"> Trigger-based notifications and commands → Problem update notifications and commands → Internal notifications → Tag names and values → Map element labels, map URL names and values → Script-type items and Browser-type items⁶ → Manual host action scripts⁶ → Manual event action scripts → <i>Description</i> parameter in <i>Item value</i> and <i>Gauge</i> widget → Primary/Secondary label <i>Text</i> parameter in <i>Honeycomb</i> widget → Column of data type <i>Text</i> in <i>Top hosts</i> widget 	<p><i>Asset tag field in host inventory.</i></p> <p>This macro may be used with a numeric index e.g. {INVENTORY.ASSET.TAG<1-9>} to point to the first, second, third, etc. host in a trigger expression. See indexed macros.</p>
{INVENTORY.CHASSIS}	<ul style="list-style-type: none"> Trigger-based notifications and commands → Problem update notifications and commands → Internal notifications → Tag names and values → Map element labels, map URL names and values → Script-type items and Browser-type items⁶ → Manual host action scripts⁶ → Manual event action scripts → <i>Description</i> parameter in <i>Item value</i> and <i>Gauge</i> widget → Primary/Secondary label <i>Text</i> parameter in <i>Honeycomb</i> widget → Column of data type <i>Text</i> in <i>Top hosts</i> widget 	<p><i>Chassis field in host inventory.</i></p> <p>This macro may be used with a numeric index e.g. {INVENTORY.CHASSIS<1-9>} to point to the first, second, third, etc. host in a trigger expression. See indexed macros.</p>
{INVENTORY.CONTACT}	<ul style="list-style-type: none"> Trigger-based notifications and commands → Problem update notifications and commands → Internal notifications → Tag names and values → Map element labels, map URL names and values → Script-type items and Browser-type items⁶ → Manual host action scripts⁶ → Manual event action scripts → <i>Description</i> parameter in <i>Item value</i> and <i>Gauge</i> widget → Primary/Secondary label <i>Text</i> parameter in <i>Honeycomb</i> widget → Column of data type <i>Text</i> in <i>Top hosts</i> widget 	<p><i>Contact field in host inventory.</i></p> <p>This macro may be used with a numeric index e.g. {INVENTORY.CONTACT<1-9>} to point to the first, second, third, etc. host in a trigger expression. See indexed macros.</p> <p>{PROFILE.CONTACT<1-9>} is deprecated.</p>

Macro	Supported in	Description
{INVENTORY.CONTRACT.NUMBER}	<ul style="list-style-type: none"> → Problem update notifications and commands → Internal notifications → Tag names and values → Map element labels, map URL names and values → Script-type items and Browser-type items⁶ → Manual host action scripts⁶ → Manual event action scripts → <i>Description</i> parameter in <i>Item value</i> and <i>Gauge</i> widget → Primary/Secondary label <i>Text</i> parameter in <i>Honeycomb</i> widget → Column of data type <i>Text</i> in <i>Top hosts</i> widget 	<p><i>Contract number field in host inventory.</i></p> <p>This macro may be used with a numeric index e.g. {INVENTORY.CONTRACT.NUMBER<1-9>} to point to the first, second, third, etc. host in a trigger expression. See indexed macros.</p>
{INVENTORY.DEPLOYMENT.STATUS}	<ul style="list-style-type: none"> → Problem update notifications and commands → Internal notifications → Tag names and values → Map element labels, map URL names and values → Script-type items and Browser-type items⁶ → Manual host action scripts⁶ → Manual event action scripts → <i>Description</i> parameter in <i>Item value</i> and <i>Gauge</i> widget → Primary/Secondary label <i>Text</i> parameter in <i>Honeycomb</i> widget → Column of data type <i>Text</i> in <i>Top hosts</i> widget 	<p><i>Deployment status field in host inventory.</i></p> <p>This macro may be used with a numeric index e.g. {INVENTORY.DEPLOYMENT.STATUS<1-9>} to point to the first, second, third, etc. host in a trigger expression. See indexed macros.</p>
{INVENTORY.HARDWARE}	<ul style="list-style-type: none"> → Problem update notifications and commands → Internal notifications → Tag names and values → Map element labels, map URL names and values → Script-type items and Browser-type items⁶ → Manual host action scripts⁶ → Manual event action scripts → <i>Description</i> parameter in <i>Item value</i> and <i>Gauge</i> widget → Primary/Secondary label <i>Text</i> parameter in <i>Honeycomb</i> widget → Column of data type <i>Text</i> in <i>Top hosts</i> widget 	<p><i>Hardware field in host inventory.</i></p> <p>This macro may be used with a numeric index e.g. {INVENTORY.HARDWARE<1-9>} to point to the first, second, third, etc. host in a trigger expression. See indexed macros.</p> <p>{PROFILE.HARDWARE<1-9>} is deprecated.</p>
{INVENTORY.HARDWARE.FULL}	<ul style="list-style-type: none"> → Problem update notifications and commands → Internal notifications → Tag names and values → Map element labels, map URL names and values → Script-type items and Browser-type items⁶ → Manual host action scripts⁶ → Manual event action scripts → <i>Description</i> parameter in <i>Item value</i> and <i>Gauge</i> widget → Primary/Secondary label <i>Text</i> parameter in <i>Honeycomb</i> widget → Column of data type <i>Text</i> in <i>Top hosts</i> widget 	<p><i>Hardware (Full details) field in host inventory.</i></p> <p>This macro may be used with a numeric index e.g. {INVENTORY.HARDWARE.FULL<1-9>} to point to the first, second, third, etc. host in a trigger expression. See indexed macros.</p>

Macro	Supported in	Description
{INVENTORY.HOST.NETMASK}	Trigger-based notifications and commands <ul style="list-style-type: none"> → Problem update notifications and commands → Internal notifications → Tag names and values → Map element labels, map URL names and values → Script-type items and Browser-type items⁶ → Manual host action scripts⁶ → Manual event action scripts → <i>Description</i> parameter in <i>Item value</i> and <i>Gauge</i> widget → Primary/Secondary label <i>Text</i> parameter in <i>Honeycomb</i> widget → Column of data type <i>Text</i> in <i>Top hosts</i> widget 	<i>Host subnet mask field in host inventory.</i> This macro may be used with a numeric index e.g. {INVENTORY.HOST.NETMASK<1-9>} to point to the first, second, third, etc. host in a trigger expression. See indexed macros .
{INVENTORY.HOST.NETWORKS}	Trigger-based notifications and commands <ul style="list-style-type: none"> → Problem update notifications and commands → Internal notifications → Tag names and values → Map element labels, map URL names and values → Script-type items and Browser-type items⁶ → Manual host action scripts⁶ → Manual event action scripts → <i>Description</i> parameter in <i>Item value</i> and <i>Gauge</i> widget → Primary/Secondary label <i>Text</i> parameter in <i>Honeycomb</i> widget → Column of data type <i>Text</i> in <i>Top hosts</i> widget 	<i>Host networks field in host inventory.</i> This macro may be used with a numeric index e.g. {INVENTORY.HOST.NETWORKS<1-9>} to point to the first, second, third, etc. host in a trigger expression. See indexed macros .
{INVENTORY.HOST.ROUTER}	Trigger-based notifications and commands <ul style="list-style-type: none"> → Problem update notifications and commands → Internal notifications → Tag names and values → Map element labels, map URL names and values → Script-type items and Browser-type items⁶ → Manual host action scripts⁶ → Manual event action scripts → <i>Description</i> parameter in <i>Item value</i> and <i>Gauge</i> widget → Primary/Secondary label <i>Text</i> parameter in <i>Honeycomb</i> widget → Column of data type <i>Text</i> in <i>Top hosts</i> widget 	<i>Host router field in host inventory.</i> This macro may be used with a numeric index e.g. {INVENTORY.HOST.ROUTER<1-9>} to point to the first, second, third, etc. host in a trigger expression. See indexed macros .
{INVENTORY.HW.ARCH}	Trigger-based notifications and commands <ul style="list-style-type: none"> → Problem update notifications and commands → Internal notifications → Tag names and values → Map element labels, map URL names and values → Script-type items and Browser-type items⁶ → Manual host action scripts⁶ → Manual event action scripts → <i>Description</i> parameter in <i>Item value</i> and <i>Gauge</i> widget → Primary/Secondary label <i>Text</i> parameter in <i>Honeycomb</i> widget → Column of data type <i>Text</i> in <i>Top hosts</i> widget 	<i>Hardware architecture field in host inventory.</i> This macro may be used with a numeric index e.g. {INVENTORY.HW.ARCH<1-9>} to point to the first, second, third, etc. host in a trigger expression. See indexed macros .

Macro	Supported in	Description
{INVENTORY.HW.DATE.DECOMM}	<p>Notifications and commands</p> <ul style="list-style-type: none"> → Problem update notifications and commands → Internal notifications → Tag names and values → Map element labels, map URL names and values → Script-type items and Browser-type items⁶ → Manual host action scripts⁶ → Manual event action scripts → <i>Description</i> parameter in <i>Item value</i> and <i>Gauge</i> widget → Primary/Secondary label <i>Text</i> parameter in <i>Honeycomb</i> widget → Column of data type <i>Text</i> in <i>Top hosts</i> widget 	<p><i>Date hardware decommissioned field in host inventory.</i></p> <p>This macro may be used with a numeric index e.g. {INVENTORY.HW.DATE.DECOMM<1-9>} to point to the first, second, third, etc. host in a trigger expression. See indexed macros.</p>
{INVENTORY.HW.DATE.EXPIRE}	<p>Notifications and commands</p> <ul style="list-style-type: none"> → Problem update notifications and commands → Internal notifications → Tag names and values → Map element labels, map URL names and values → Script-type items and Browser-type items⁶ → Manual host action scripts⁶ → Manual event action scripts → <i>Description</i> parameter in <i>Item value</i> and <i>Gauge</i> widget → Primary/Secondary label <i>Text</i> parameter in <i>Honeycomb</i> widget → Column of data type <i>Text</i> in <i>Top hosts</i> widget 	<p><i>Date hardware maintenance expires field in host inventory.</i></p> <p>This macro may be used with a numeric index e.g. {INVENTORY.HW.DATE.EXPIRE<1-9>} to point to the first, second, third, etc. host in a trigger expression. See indexed macros.</p>
{INVENTORY.HW.DATE.INSTALL}	<p>Notifications and commands</p> <ul style="list-style-type: none"> → Problem update notifications and commands → Internal notifications → Tag names and values → Map element labels, map URL names and values → Script-type items and Browser-type items⁶ → Manual host action scripts⁶ → Manual event action scripts → <i>Description</i> parameter in <i>Item value</i> and <i>Gauge</i> widget → Primary/Secondary label <i>Text</i> parameter in <i>Honeycomb</i> widget → Column of data type <i>Text</i> in <i>Top hosts</i> widget 	<p><i>Date hardware installed field in host inventory.</i></p> <p>This macro may be used with a numeric index e.g. {INVENTORY.HW.DATE.INSTALL<1-9>} to point to the first, second, third, etc. host in a trigger expression. See indexed macros.</p>
{INVENTORY.HW.DATE.PURCHASE}	<p>Notifications and commands</p> <ul style="list-style-type: none"> → Problem update notifications and commands → Internal notifications → Tag names and values → Map element labels, map URL names and values → Script-type items and Browser-type items⁶ → Manual host action scripts⁶ → Manual event action scripts → <i>Description</i> parameter in <i>Item value</i> and <i>Gauge</i> widget → Primary/Secondary label <i>Text</i> parameter in <i>Honeycomb</i> widget → Column of data type <i>Text</i> in <i>Top hosts</i> widget 	<p><i>Date hardware purchased field in host inventory.</i></p> <p>This macro may be used with a numeric index e.g. {INVENTORY.HW.DATE.PURCHASE<1-9>} to point to the first, second, third, etc. host in a trigger expression. See indexed macros.</p>

Macro	Supported in	Description
{INVENTORY.INSTALLER.NAME}	<ul style="list-style-type: none"> → Problem update notifications and commands → Internal notifications → Tag names and values → Map element labels, map URL names and values → Script-type items and Browser-type items⁶ → Manual host action scripts⁶ → Manual event action scripts → <i>Description</i> parameter in <i>Item value</i> and <i>Gauge</i> widget → Primary/Secondary label <i>Text</i> parameter in <i>Honeycomb</i> widget → Column of data type <i>Text</i> in <i>Top hosts</i> widget 	<p><i>Installer name field in host inventory.</i></p> <p>This macro may be used with a numeric index e.g. {INVENTORY.INSTALLER.NAME<1-9>} to point to the first, second, third, etc. host in a trigger expression. See indexed macros.</p>
{INVENTORY.LOCATION}	<ul style="list-style-type: none"> → Problem update notifications and commands → Internal notifications → Tag names and values → Map element labels, map URL names and values → Script-type items and Browser-type items⁶ → Manual host action scripts⁶ → Manual event action scripts → <i>Description</i> parameter in <i>Item value</i> and <i>Gauge</i> widget → Primary/Secondary label <i>Text</i> parameter in <i>Honeycomb</i> widget → Column of data type <i>Text</i> in <i>Top hosts</i> widget 	<p><i>Location field in host inventory.</i></p> <p>This macro may be used with a numeric index e.g. {INVENTORY.LOCATION<1-9>} to point to the first, second, third, etc. host in a trigger expression. See indexed macros.</p> <p>{PROFILE.LOCATION<1-9>} is deprecated.</p>
{INVENTORY.LOCATION.LAT}	<ul style="list-style-type: none"> → Problem update notifications and commands → Internal notifications → Tag names and values → Map element labels, map URL names and values → Script-type items and Browser-type items⁶ → Manual host action scripts⁶ → Manual event action scripts → <i>Description</i> parameter in <i>Item value</i> and <i>Gauge</i> widget → Primary/Secondary label <i>Text</i> parameter in <i>Honeycomb</i> widget → Column of data type <i>Text</i> in <i>Top hosts</i> widget 	<p><i>Location latitude field in host inventory.</i></p> <p>This macro may be used with a numeric index e.g. {INVENTORY.LOCATION.LAT<1-9>} to point to the first, second, third, etc. host in a trigger expression. See indexed macros.</p>
{INVENTORY.LOCATION.LON}	<ul style="list-style-type: none"> → Problem update notifications and commands → Internal notifications → Tag names and values → Map element labels, map URL names and values → Script-type items and Browser-type items⁶ → Manual host action scripts⁶ → Manual event action scripts → <i>Description</i> parameter in <i>Item value</i> and <i>Gauge</i> widget → Primary/Secondary label <i>Text</i> parameter in <i>Honeycomb</i> widget → Column of data type <i>Text</i> in <i>Top hosts</i> widget 	<p><i>Location longitude field in host inventory.</i></p> <p>This macro may be used with a numeric index e.g. {INVENTORY.LOCATION.LON<1-9>} to point to the first, second, third, etc. host in a trigger expression. See indexed macros.</p>

Macro	Supported in	Description
{INVENTORY.MACADDRESS.A}	<ul style="list-style-type: none"> → Trigger-based notifications and commands → Problem update notifications and commands → Internal notifications → Tag names and values → Map element labels, map URL names and values → Script-type items and Browser-type items⁶ → Manual host action scripts⁶ → Manual event action scripts → <i>Description</i> parameter in <i>Item value</i> and <i>Gauge</i> widget → Primary/Secondary label <i>Text</i> parameter in <i>Honeycomb</i> widget → Column of data type <i>Text</i> in <i>Top hosts</i> widget 	<p><i>MAC address A field in host inventory.</i></p> <p>This macro may be used with a numeric index e.g. {INVENTORY.MACADDRESS.A<1-9>} to point to the first, second, third, etc. host in a trigger expression. See indexed macros.</p> <p>{PROFILE.MACADDRESS<1-9>} is deprecated.</p>
{INVENTORY.MACADDRESS.B}	<ul style="list-style-type: none"> → Trigger-based notifications and commands → Problem update notifications and commands → Internal notifications → Tag names and values → Map element labels, map URL names and values → Script-type items and Browser-type items⁶ → Manual host action scripts⁶ → Manual event action scripts → <i>Description</i> parameter in <i>Item value</i> and <i>Gauge</i> widget → Primary/Secondary label <i>Text</i> parameter in <i>Honeycomb</i> widget → Column of data type <i>Text</i> in <i>Top hosts</i> widget 	<p><i>MAC address B field in host inventory.</i></p> <p>This macro may be used with a numeric index e.g. {INVENTORY.MACADDRESS.B<1-9>} to point to the first, second, third, etc. host in a trigger expression. See indexed macros.</p>
{INVENTORY.MODEL}	<ul style="list-style-type: none"> → Trigger-based notifications and commands → Problem update notifications and commands → Internal notifications → Tag names and values → Map element labels, map URL names and values → Script-type items and Browser-type items⁶ → Manual host action scripts⁶ → Manual event action scripts → <i>Description</i> parameter in <i>Item value</i> and <i>Gauge</i> widget → Primary/Secondary label <i>Text</i> parameter in <i>Honeycomb</i> widget → Column of data type <i>Text</i> in <i>Top hosts</i> widget 	<p><i>Model field in host inventory.</i></p> <p>This macro may be used with a numeric index e.g. {INVENTORY.MODEL<1-9>} to point to the first, second, third, etc. host in a trigger expression. See indexed macros.</p>
{INVENTORY.NAME}	<ul style="list-style-type: none"> → Trigger-based notifications and commands → Problem update notifications and commands → Internal notifications → Tag names and values → Map element labels, map URL names and values → Script-type items and Browser-type items⁶ → Manual host action scripts⁶ → Manual event action scripts → <i>Description</i> parameter in <i>Item value</i> and <i>Gauge</i> widget → Primary/Secondary label <i>Text</i> parameter in <i>Honeycomb</i> widget → Column of data type <i>Text</i> in <i>Top hosts</i> widget 	<p><i>Name field in host inventory.</i></p> <p>This macro may be used with a numeric index e.g. {INVENTORY.NAME<1-9>} to point to the first, second, third, etc. host in a trigger expression. See indexed macros.</p> <p>{PROFILE.NAME<1-9>} is deprecated.</p>

Macro	Supported in	Description
{INVENTORY.NOTES}	<ul style="list-style-type: none"> Trigger-based notifications and commands → Problem update notifications and commands → Internal notifications → Tag names and values → Map element labels, map URL names and values → Script-type items and Browser-type items⁶ → Manual host action scripts⁶ → Manual event action scripts → <i>Description</i> parameter in <i>Item value</i> and <i>Gauge</i> widget → Primary/Secondary label <i>Text</i> parameter in <i>Honeycomb</i> widget → Column of data type <i>Text</i> in <i>Top hosts</i> widget 	<p><i>Notes field in host inventory.</i></p> <p>This macro may be used with a numeric index e.g. {INVENTORY.NOTES<1-9>} to point to the first, second, third, etc. host in a trigger expression. See indexed macros.</p> <p>{PROFILE.NOTES<1-9>} is deprecated.</p>
{INVENTORY.OOB.IP}	<ul style="list-style-type: none"> Trigger-based notifications and commands → Problem update notifications and commands → Internal notifications → Tag names and values → Map element labels, map URL names and values → Script-type items and Browser-type items⁶ → Manual host action scripts⁶ → Manual event action scripts → <i>Description</i> parameter in <i>Item value</i> and <i>Gauge</i> widget → Primary/Secondary label <i>Text</i> parameter in <i>Honeycomb</i> widget → Column of data type <i>Text</i> in <i>Top hosts</i> widget 	<p><i>OOB IP address field in host inventory.</i></p> <p>This macro may be used with a numeric index e.g. {INVENTORY.OOB.IP<1-9>} to point to the first, second, third, etc. host in a trigger expression. See indexed macros.</p>
{INVENTORY.OOB.NETMASK}	<ul style="list-style-type: none"> Trigger-based notifications and commands → Problem update notifications and commands → Internal notifications → Tag names and values → Map element labels, map URL names and values → Script-type items and Browser-type items⁶ → Manual host action scripts⁶ → Manual event action scripts → <i>Description</i> parameter in <i>Item value</i> and <i>Gauge</i> widget → Primary/Secondary label <i>Text</i> parameter in <i>Honeycomb</i> widget → Column of data type <i>Text</i> in <i>Top hosts</i> widget 	<p><i>OOB subnet mask field in host inventory.</i></p> <p>This macro may be used with a numeric index e.g. {INVENTORY.OOB.NETMASK<1-9>} to point to the first, second, third, etc. host in a trigger expression. See indexed macros.</p>
{INVENTORY.OOB.ROUTER}	<ul style="list-style-type: none"> Trigger-based notifications and commands → Problem update notifications and commands → Internal notifications → Tag names and values → Map element labels, map URL names and values → Script-type items and Browser-type items⁶ → Manual host action scripts⁶ → Manual event action scripts → <i>Description</i> parameter in <i>Item value</i> and <i>Gauge</i> widget → Primary/Secondary label <i>Text</i> parameter in <i>Honeycomb</i> widget → Column of data type <i>Text</i> in <i>Top hosts</i> widget 	<p><i>OOB router field in host inventory.</i></p> <p>This macro may be used with a numeric index e.g. {INVENTORY.OOB.ROUTER<1-9>} to point to the first, second, third, etc. host in a trigger expression. See indexed macros.</p>

Macro	Supported in	Description
{INVENTORY.OS}	<ul style="list-style-type: none"> → Trigger-based notifications and commands → Problem update notifications and commands → Internal notifications → Tag names and values → Map element labels, map URL names and values → Script-type items and Browser-type items⁶ → Manual host action scripts⁶ → Manual event action scripts → <i>Description</i> parameter in <i>Item value</i> and <i>Gauge</i> widget → Primary/Secondary label <i>Text</i> parameter in <i>Honeycomb</i> widget → Column of data type <i>Text</i> in <i>Top hosts</i> widget 	<p><i>OS field in host inventory.</i></p> <p>This macro may be used with a numeric index e.g. {INVENTORY.OS<1-9>} to point to the first, second, third, etc. host in a trigger expression. See indexed macros.</p> <p>{PROFILE.OS<1-9>} is deprecated.</p>
{INVENTORY.OS.FULL}	<ul style="list-style-type: none"> → Trigger-based notifications and commands → Problem update notifications and commands → Internal notifications → Tag names and values → Map element labels, map URL names and values → Script-type items and Browser-type items⁶ → Manual host action scripts⁶ → Manual event action scripts → <i>Description</i> parameter in <i>Item value</i> and <i>Gauge</i> widget → Primary/Secondary label <i>Text</i> parameter in <i>Honeycomb</i> widget → Column of data type <i>Text</i> in <i>Top hosts</i> widget 	<p><i>OS (Full details) field in host inventory.</i></p> <p>This macro may be used with a numeric index e.g. {INVENTORY.OS.FULL<1-9>} to point to the first, second, third, etc. host in a trigger expression. See indexed macros.</p>
{INVENTORY.OS.SHORT}	<ul style="list-style-type: none"> → Trigger-based notifications and commands → Problem update notifications and commands → Internal notifications → Tag names and values → Map element labels, map URL names and values → Script-type items and Browser-type items⁶ → Manual host action scripts⁶ → Manual event action scripts → <i>Description</i> parameter in <i>Item value</i> and <i>Gauge</i> widget → Primary/Secondary label <i>Text</i> parameter in <i>Honeycomb</i> widget → Column of data type <i>Text</i> in <i>Top hosts</i> widget 	<p><i>OS (Short) field in host inventory.</i></p> <p>This macro may be used with a numeric index e.g. {INVENTORY.OS.SHORT<1-9>} to point to the first, second, third, etc. host in a trigger expression. See indexed macros.</p>
{INVENTORY.POC.PRIMARY.CELL}	<ul style="list-style-type: none"> → Trigger-based notifications and commands → Problem update notifications and commands → Internal notifications → Tag names and values → Map element labels, map URL names and values → Script-type items and Browser-type items⁶ → Manual host action scripts⁶ → Manual event action scripts → <i>Description</i> parameter in <i>Item value</i> and <i>Gauge</i> widget → Primary/Secondary label <i>Text</i> parameter in <i>Honeycomb</i> widget → Column of data type <i>Text</i> in <i>Top hosts</i> widget 	<p><i>Primary POC cell field in host inventory.</i></p> <p>This macro may be used with a numeric index e.g. {INVENTORY.POC.PRIMARY.CELL<1-9>} to point to the first, second, third, etc. host in a trigger expression. See indexed macros.</p>

Macro	Supported in	Description
{INVENTORY.POC.PRIMARY.EMAIL}	<ul style="list-style-type: none"> → Problem update notifications and commands → Internal notifications → Tag names and values → Map element labels, map URL names and values → Script-type items and Browser-type items⁶ → Manual host action scripts⁶ → Manual event action scripts → <i>Description</i> parameter in <i>Item value</i> and <i>Gauge</i> widget → Primary/Secondary label <i>Text</i> parameter in <i>Honeycomb</i> widget → Column of data type <i>Text</i> in <i>Top hosts</i> widget 	<p><i>Primary POC email field in host inventory.</i></p> <p>This macro may be used with a numeric index e.g. {INVENTORY.POC.PRIMARY.EMAIL<1-9>} to point to the first, second, third, etc. host in a trigger expression. See indexed macros.</p>
{INVENTORY.POC.PRIMARY.NAME}	<ul style="list-style-type: none"> → Problem update notifications and commands → Internal notifications → Tag names and values → Map element labels, map URL names and values → Script-type items and Browser-type items⁶ → Manual host action scripts⁶ → Manual event action scripts → <i>Description</i> parameter in <i>Item value</i> and <i>Gauge</i> widget → Primary/Secondary label <i>Text</i> parameter in <i>Honeycomb</i> widget → Column of data type <i>Text</i> in <i>Top hosts</i> widget 	<p><i>Primary POC name field in host inventory.</i></p> <p>This macro may be used with a numeric index e.g. {INVENTORY.POC.PRIMARY.NAME<1-9>} to point to the first, second, third, etc. host in a trigger expression. See indexed macros.</p>
{INVENTORY.POC.PRIMARY.NOTES}	<ul style="list-style-type: none"> → Problem update notifications and commands → Internal notifications → Tag names and values → Map element labels, map URL names and values → Script-type items and Browser-type items⁶ → Manual host action scripts⁶ → Manual event action scripts → <i>Description</i> parameter in <i>Item value</i> and <i>Gauge</i> widget → Primary/Secondary label <i>Text</i> parameter in <i>Honeycomb</i> widget → Column of data type <i>Text</i> in <i>Top hosts</i> widget 	<p><i>Primary POC notes field in host inventory.</i></p> <p>This macro may be used with a numeric index e.g. {INVENTORY.POC.PRIMARY.NOTES<1-9>} to point to the first, second, third, etc. host in a trigger expression. See indexed macros.</p>
{INVENTORY.POC.PRIMARY.PHONE.A}	<ul style="list-style-type: none"> → Problem update notifications and commands → Internal notifications → Tag names and values → Map element labels, map URL names and values → Script-type items and Browser-type items⁶ → Manual host action scripts⁶ → Manual event action scripts → <i>Description</i> parameter in <i>Item value</i> and <i>Gauge</i> widget → Primary/Secondary label <i>Text</i> parameter in <i>Honeycomb</i> widget → Column of data type <i>Text</i> in <i>Top hosts</i> widget 	<p><i>Primary POC phone A field in host inventory.</i></p> <p>This macro may be used with a numeric index e.g. {INVENTORY.POC.PRIMARY.PHONE.A<1-9>} to point to the first, second, third, etc. host in a trigger expression. See indexed macros.</p>

Macro	Supported in	Description
{INVENTORY.POC.PRIMARY.PHONE.B}	<ul style="list-style-type: none"> → Problem update notifications and commands → Internal notifications → Tag names and values → Map element labels, map URL names and values → Script-type items and Browser-type items⁶ → Manual host action scripts⁶ → Manual event action scripts → <i>Description</i> parameter in <i>Item value</i> and <i>Gauge</i> widget → Primary/Secondary label <i>Text</i> parameter in <i>Honeycomb</i> widget → Column of data type <i>Text</i> in <i>Top hosts</i> widget 	<p><i>Primary POC phone B field in host inventory.</i></p> <p>This macro may be used with a numeric index e.g. {INVENTORY.POC.PRIMARY.PHONE.B<1-9>} to point to the first, second, third, etc. host in a trigger expression. See indexed macros.</p>
{INVENTORY.POC.PRIMARY.SCREEN}	<ul style="list-style-type: none"> → Problem update notifications and commands → Internal notifications → Tag names and values → Map element labels, map URL names and values → Script-type items and Browser-type items⁶ → Manual host action scripts⁶ → Manual event action scripts → <i>Description</i> parameter in <i>Item value</i> and <i>Gauge</i> widget → Primary/Secondary label <i>Text</i> parameter in <i>Honeycomb</i> widget → Column of data type <i>Text</i> in <i>Top hosts</i> widget 	<p><i>Primary POC screen name field in host inventory.</i></p> <p>This macro may be used with a numeric index e.g. {INVENTORY.POC.PRIMARY.SCREEN<1-9>} to point to the first, second, third, etc. host in a trigger expression. See indexed macros.</p>
{INVENTORY.POC.SECONDARY.CELL}	<ul style="list-style-type: none"> → Problem update notifications and commands → Internal notifications → Tag names and values → Map element labels, map URL names and values → Script-type items and Browser-type items⁶ → Manual host action scripts⁶ → Manual event action scripts → <i>Description</i> parameter in <i>Item value</i> and <i>Gauge</i> widget → Primary/Secondary label <i>Text</i> parameter in <i>Honeycomb</i> widget → Column of data type <i>Text</i> in <i>Top hosts</i> widget 	<p><i>Secondary POC cell field in host inventory.</i></p> <p>This macro may be used with a numeric index e.g. {INVENTORY.POC.SECONDARY.CELL<1-9>} to point to the first, second, third, etc. host in a trigger expression. See indexed macros.</p>
{INVENTORY.POC.SECONDARY.EMAIL}	<ul style="list-style-type: none"> → Problem update notifications and commands → Internal notifications → Tag names and values → Map element labels, map URL names and values → Script-type items and Browser-type items⁶ → Manual host action scripts⁶ → Manual event action scripts → <i>Description</i> parameter in <i>Item value</i> and <i>Gauge</i> widget → Primary/Secondary label <i>Text</i> parameter in <i>Honeycomb</i> widget → Column of data type <i>Text</i> in <i>Top hosts</i> widget 	<p><i>Secondary POC email field in host inventory.</i></p> <p>This macro may be used with a numeric index e.g. {INVENTORY.POC.SECONDARY.EMAIL<1-9>} to point to the first, second, third, etc. host in a trigger expression. See indexed macros.</p>

Macro	Supported in	Description
{INVENTORY.POC.SECONDARY.NAME}	<ul style="list-style-type: none"> → Problem update notifications and commands → Internal notifications → Tag names and values → Map element labels, map URL names and values → Script-type items and Browser-type items⁶ → Manual host action scripts⁶ → Manual event action scripts → <i>Description</i> parameter in <i>Item value</i> and <i>Gauge</i> widget → Primary/Secondary label <i>Text</i> parameter in <i>Honeycomb</i> widget → Column of data type <i>Text</i> in <i>Top hosts</i> widget 	<p><i>Secondary POC name field in host inventory.</i></p> <p>This macro may be used with a numeric index e.g. {INVENTORY.POC.SECONDARY.NAME<1-9>} to point to the first, second, third, etc. host in a trigger expression. See indexed macros.</p>
{INVENTORY.POC.SECONDARY.NOTES}	<ul style="list-style-type: none"> → Problem update notifications and commands → Internal notifications → Tag names and values → Map element labels, map URL names and values → Script-type items and Browser-type items⁶ → Manual host action scripts⁶ → Manual event action scripts → <i>Description</i> parameter in <i>Item value</i> and <i>Gauge</i> widget → Primary/Secondary label <i>Text</i> parameter in <i>Honeycomb</i> widget → Column of data type <i>Text</i> in <i>Top hosts</i> widget 	<p><i>Secondary POC notes field in host inventory.</i></p> <p>This macro may be used with a numeric index e.g. {INVENTORY.POC.SECONDARY.NOTES<1-9>} to point to the first, second, third, etc. host in a trigger expression. See indexed macros.</p>
{INVENTORY.POC.SECONDARY.PHONE.A}	<ul style="list-style-type: none"> → Problem update notifications and commands → Internal notifications → Tag names and values → Map element labels, map URL names and values → Script-type items and Browser-type items⁶ → Manual host action scripts⁶ → Manual event action scripts → <i>Description</i> parameter in <i>Item value</i> and <i>Gauge</i> widget → Primary/Secondary label <i>Text</i> parameter in <i>Honeycomb</i> widget → Column of data type <i>Text</i> in <i>Top hosts</i> widget 	<p><i>Secondary POC phone A field in host inventory.</i></p> <p>This macro may be used with a numeric index e.g. {INVENTORY.POC.SECONDARY.PHONE.A<1-9>} to point to the first, second, third, etc. host in a trigger expression. See indexed macros.</p>
{INVENTORY.POC.SECONDARY.PHONE.B}	<ul style="list-style-type: none"> → Problem update notifications and commands → Internal notifications → Tag names and values → Map element labels, map URL names and values → Script-type items and Browser-type items⁶ → Manual host action scripts⁶ → Manual event action scripts → <i>Description</i> parameter in <i>Item value</i> and <i>Gauge</i> widget → Primary/Secondary label <i>Text</i> parameter in <i>Honeycomb</i> widget → Column of data type <i>Text</i> in <i>Top hosts</i> widget 	<p><i>Secondary POC phone B field in host inventory.</i></p> <p>This macro may be used with a numeric index e.g. {INVENTORY.POC.SECONDARY.PHONE.B<1-9>} to point to the first, second, third, etc. host in a trigger expression. See indexed macros.</p>

Macro	Supported in	Description
{INVENTORY.POC.SECONDARY.SCREEN}	<ul style="list-style-type: none"> → Problem update notifications and commands → Internal notifications → Tag names and values → Map element labels, map URL names and values → Script-type items and Browser-type items⁶ → Manual host action scripts⁶ → Manual event action scripts → <i>Description</i> parameter in <i>Item value</i> and <i>Gauge</i> widget → Primary/Secondary label <i>Text</i> parameter in <i>Honeycomb</i> widget → Column of data type <i>Text</i> in <i>Top hosts</i> widget 	<p><i>Secondary POC screen name field in host inventory.</i></p> <p>This macro may be used with a numeric index e.g. {INVENTORY.POC.SECONDARY.SCREEN<1-9>} to point to the first, second, third, etc. host in a trigger expression. See indexed macros.</p>
{INVENTORY.SERIALNO.A}	<ul style="list-style-type: none"> → Problem update notifications and commands → Internal notifications → Tag names and values → Map element labels, map URL names and values → Script-type items and Browser-type items⁶ → Manual host action scripts⁶ → Manual event action scripts → <i>Description</i> parameter in <i>Item value</i> and <i>Gauge</i> widget → Primary/Secondary label <i>Text</i> parameter in <i>Honeycomb</i> widget → Column of data type <i>Text</i> in <i>Top hosts</i> widget 	<p><i>Serial number A field in host inventory.</i></p> <p>This macro may be used with a numeric index e.g. {INVENTORY.SERIALNO.A<1-9>} to point to the first, second, third, etc. host in a trigger expression. See indexed macros.</p> <p>{PROFILE.SERIALNO<1-9>} is deprecated.</p>
{INVENTORY.SERIALNO.B}	<ul style="list-style-type: none"> → Problem update notifications and commands → Internal notifications → Tag names and values → Map element labels, map URL names and values → Script-type items and Browser-type items⁶ → Manual host action scripts⁶ → Manual event action scripts → <i>Description</i> parameter in <i>Item value</i> and <i>Gauge</i> widget → Primary/Secondary label <i>Text</i> parameter in <i>Honeycomb</i> widget → Column of data type <i>Text</i> in <i>Top hosts</i> widget 	<p><i>Serial number B field in host inventory.</i></p> <p>This macro may be used with a numeric index e.g. {INVENTORY.SERIALNO.B<1-9>} to point to the first, second, third, etc. host in a trigger expression. See indexed macros.</p>
{INVENTORY.SITE.ADDRESS.A}	<ul style="list-style-type: none"> → Problem update notifications and commands → Internal notifications → Tag names and values → Map element labels, map URL names and values → Script-type items and Browser-type items⁶ → Manual host action scripts⁶ → Manual event action scripts → <i>Description</i> parameter in <i>Item value</i> and <i>Gauge</i> widget → Primary/Secondary label <i>Text</i> parameter in <i>Honeycomb</i> widget → Column of data type <i>Text</i> in <i>Top hosts</i> widget 	<p><i>Site address A field in host inventory.</i></p> <p>This macro may be used with a numeric index e.g. {INVENTORY.SITE.ADDRESS.A<1-9>} to point to the first, second, third, etc. host in a trigger expression. See indexed macros.</p>

Macro	Supported in	Description
{INVENTORY.SITE.ADDRESS.B}	<ul style="list-style-type: none"> → Trigger-based notifications and commands → Problem update notifications and commands → Internal notifications → Tag names and values → Map element labels, map URL names and values → Script-type items and Browser-type items⁶ → Manual host action scripts⁶ → Manual event action scripts → <i>Description</i> parameter in <i>Item value</i> and <i>Gauge</i> widget → Primary/Secondary label <i>Text</i> parameter in <i>Honeycomb</i> widget → Column of data type <i>Text</i> in <i>Top hosts</i> widget 	<p><i>Site address B field in host inventory.</i></p> <p>This macro may be used with a numeric index e.g. {INVENTORY.SITE.ADDRESS.B<1-9>} to point to the first, second, third, etc. host in a trigger expression. See indexed macros.</p>
{INVENTORY.SITE.ADDRESS.C}	<ul style="list-style-type: none"> → Trigger-based notifications and commands → Problem update notifications and commands → Internal notifications → Tag names and values → Map element labels, map URL names and values → Script-type items and Browser-type items⁶ → Manual host action scripts⁶ → Manual event action scripts → <i>Description</i> parameter in <i>Item value</i> and <i>Gauge</i> widget → Primary/Secondary label <i>Text</i> parameter in <i>Honeycomb</i> widget → Column of data type <i>Text</i> in <i>Top hosts</i> widget 	<p><i>Site address C field in host inventory.</i></p> <p>This macro may be used with a numeric index e.g. {INVENTORY.SITE.ADDRESS.C<1-9>} to point to the first, second, third, etc. host in a trigger expression. See indexed macros.</p>
{INVENTORY.SITE.CITY}	<ul style="list-style-type: none"> → Trigger-based notifications and commands → Problem update notifications and commands → Internal notifications → Tag names and values → Map element labels, map URL names and values → Script-type items and Browser-type items⁶ → Manual host action scripts⁶ → Manual event action scripts → <i>Description</i> parameter in <i>Item value</i> and <i>Gauge</i> widget → Primary/Secondary label <i>Text</i> parameter in <i>Honeycomb</i> widget → Column of data type <i>Text</i> in <i>Top hosts</i> widget 	<p><i>Site city field in host inventory.</i></p> <p>This macro may be used with a numeric index e.g. {INVENTORY.SITE.CITY<1-9>} to point to the first, second, third, etc. host in a trigger expression. See indexed macros.</p>
{INVENTORY.SITE.COUNTRY}	<ul style="list-style-type: none"> → Trigger-based notifications and commands → Problem update notifications and commands → Internal notifications → Tag names and values → Map element labels, map URL names and values → Script-type items and Browser-type items⁶ → Manual host action scripts⁶ → Manual event action scripts → <i>Description</i> parameter in <i>Item value</i> and <i>Gauge</i> widget → Primary/Secondary label <i>Text</i> parameter in <i>Honeycomb</i> widget → Column of data type <i>Text</i> in <i>Top hosts</i> widget 	<p><i>Site country field in host inventory.</i></p> <p>This macro may be used with a numeric index e.g. {INVENTORY.SITE.COUNTRY<1-9>} to point to the first, second, third, etc. host in a trigger expression. See indexed macros.</p>

Macro	Supported in	Description
{INVENTORY.SITE.NOTES}	<ul style="list-style-type: none"> → Trigger-based notifications and commands → Problem update notifications and commands → Internal notifications → Tag names and values → Map element labels, map URL names and values → Script-type items and Browser-type items⁶ → Manual host action scripts⁶ → Manual event action scripts → <i>Description</i> parameter in <i>Item value</i> and <i>Gauge</i> widget → Primary/Secondary label <i>Text</i> parameter in <i>Honeycomb</i> widget → Column of data type <i>Text</i> in <i>Top hosts</i> widget 	<p><i>Site notes field in host inventory.</i></p> <p>This macro may be used with a numeric index e.g. {INVENTORY.SITE.NOTES<1-9>} to point to the first, second, third, etc. host in a trigger expression. See indexed macros.</p>
{INVENTORY.SITE.RACK}	<ul style="list-style-type: none"> → Trigger-based notifications and commands → Problem update notifications and commands → Internal notifications → Tag names and values → Map element labels, map URL names and values → Script-type items and Browser-type items⁶ → Manual host action scripts⁶ → Manual event action scripts → <i>Description</i> parameter in <i>Item value</i> and <i>Gauge</i> widget → Primary/Secondary label <i>Text</i> parameter in <i>Honeycomb</i> widget → Column of data type <i>Text</i> in <i>Top hosts</i> widget 	<p><i>Site rack location field in host inventory.</i></p> <p>This macro may be used with a numeric index e.g. {INVENTORY.SITE.RACK<1-9>} to point to the first, second, third, etc. host in a trigger expression. See indexed macros.</p>
{INVENTORY.SITE.STATE}	<ul style="list-style-type: none"> → Trigger-based notifications and commands → Problem update notifications and commands → Internal notifications → Tag names and values → Map element labels, map URL names and values → Script-type items and Browser-type items⁶ → Manual host action scripts⁶ → Manual event action scripts → <i>Description</i> parameter in <i>Item value</i> and <i>Gauge</i> widget → Primary/Secondary label <i>Text</i> parameter in <i>Honeycomb</i> widget → Column of data type <i>Text</i> in <i>Top hosts</i> widget 	<p><i>Site state/province field in host inventory.</i></p> <p>This macro may be used with a numeric index e.g. {INVENTORY.SITE.STATE<1-9>} to point to the first, second, third, etc. host in a trigger expression. See indexed macros.</p>
{INVENTORY.SITE.ZIP}	<ul style="list-style-type: none"> → Trigger-based notifications and commands → Problem update notifications and commands → Internal notifications → Tag names and values → Map element labels, map URL names and values → Script-type items and Browser-type items⁶ → Manual host action scripts⁶ → Manual event action scripts → <i>Description</i> parameter in <i>Item value</i> and <i>Gauge</i> widget → Primary/Secondary label <i>Text</i> parameter in <i>Honeycomb</i> widget → Column of data type <i>Text</i> in <i>Top hosts</i> widget 	<p><i>Site ZIP/postal field in host inventory.</i></p> <p>This macro may be used with a numeric index e.g. {INVENTORY.SITE.ZIP<1-9>} to point to the first, second, third, etc. host in a trigger expression. See indexed macros.</p>

Macro	Supported in	Description
{INVENTORY.SOFTWARE}	<ul style="list-style-type: none"> → Problem update notifications and commands → Internal notifications → Tag names and values → Map element labels, map URL names and values → Script-type items and Browser-type items⁶ → Manual host action scripts⁶ → Manual event action scripts → <i>Description</i> parameter in <i>Item value</i> and <i>Gauge</i> widget → Primary/Secondary label <i>Text</i> parameter in <i>Honeycomb</i> widget → Column of data type <i>Text</i> in <i>Top hosts</i> widget 	<p><i>Software field in host inventory.</i></p> <p>This macro may be used with a numeric index e.g. {INVENTORY.SOFTWARE<1-9>} to point to the first, second, third, etc. host in a trigger expression. See indexed macros.</p> <p>{PROFILE.SOFTWARE<1-9>} is deprecated.</p>
{INVENTORY.SOFTWARE.APP.A}	<ul style="list-style-type: none"> → Problem update notifications and commands → Internal notifications → Tag names and values → Map element labels, map URL names and values → Script-type items and Browser-type items⁶ → Manual host action scripts⁶ → Manual event action scripts → <i>Description</i> parameter in <i>Item value</i> and <i>Gauge</i> widget → Primary/Secondary label <i>Text</i> parameter in <i>Honeycomb</i> widget → Column of data type <i>Text</i> in <i>Top hosts</i> widget 	<p><i>Software application A field in host inventory.</i></p> <p>This macro may be used with a numeric index e.g. {INVENTORY.SOFTWARE.APP.A<1-9>} to point to the first, second, third, etc. host in a trigger expression. See indexed macros.</p>
{INVENTORY.SOFTWARE.APP.B}	<ul style="list-style-type: none"> → Problem update notifications and commands → Internal notifications → Tag names and values → Map element labels, map URL names and values → Script-type items and Browser-type items⁶ → Manual host action scripts⁶ → Manual event action scripts → <i>Description</i> parameter in <i>Item value</i> and <i>Gauge</i> widget → Primary/Secondary label <i>Text</i> parameter in <i>Honeycomb</i> widget → Column of data type <i>Text</i> in <i>Top hosts</i> widget 	<p><i>Software application B field in host inventory.</i></p> <p>This macro may be used with a numeric index e.g. {INVENTORY.SOFTWARE.APP.B<1-9>} to point to the first, second, third, etc. host in a trigger expression. See indexed macros.</p>
{INVENTORY.SOFTWARE.APP.C}	<ul style="list-style-type: none"> → Problem update notifications and commands → Internal notifications → Tag names and values → Map element labels, map URL names and values → Script-type items and Browser-type items⁶ → Manual host action scripts⁶ → Manual event action scripts → <i>Description</i> parameter in <i>Item value</i> and <i>Gauge</i> widget → Primary/Secondary label <i>Text</i> parameter in <i>Honeycomb</i> widget → Column of data type <i>Text</i> in <i>Top hosts</i> widget 	<p><i>Software application C field in host inventory.</i></p> <p>This macro may be used with a numeric index e.g. {INVENTORY.SOFTWARE.APP.C<1-9>} to point to the first, second, third, etc. host in a trigger expression. See indexed macros.</p>

Macro	Supported in	Description
{INVENTORY.SOFTWARE.APP.D}	<ul style="list-style-type: none"> → Trigger-based notifications and commands → Problem update notifications and commands → Internal notifications → Tag names and values → Map element labels, map URL names and values → Script-type items and Browser-type items⁶ → Manual host action scripts⁶ → Manual event action scripts → <i>Description</i> parameter in <i>Item value</i> and <i>Gauge</i> widget → Primary/Secondary label <i>Text</i> parameter in <i>Honeycomb</i> widget → Column of data type <i>Text</i> in <i>Top hosts</i> widget 	<p><i>Software application D field in host inventory.</i></p> <p>This macro may be used with a numeric index e.g. {INVENTORY.SOFTWARE.APP.D<1-9>} to point to the first, second, third, etc. host in a trigger expression. See indexed macros.</p>
{INVENTORY.SOFTWARE.APP.E}	<ul style="list-style-type: none"> → Trigger-based notifications and commands → Problem update notifications and commands → Internal notifications → Tag names and values → Map element labels, map URL names and values → Script-type items and Browser-type items⁶ → Manual host action scripts⁶ → Manual event action scripts → <i>Description</i> parameter in <i>Item value</i> and <i>Gauge</i> widget → Primary/Secondary label <i>Text</i> parameter in <i>Honeycomb</i> widget → Column of data type <i>Text</i> in <i>Top hosts</i> widget 	<p><i>Software application E field in host inventory.</i></p> <p>This macro may be used with a numeric index e.g. {INVENTORY.SOFTWARE.APP.E<1-9>} to point to the first, second, third, etc. host in a trigger expression. See indexed macros.</p>
{INVENTORY.SOFTWARE.FULL}	<ul style="list-style-type: none"> → Trigger-based notifications and commands → Problem update notifications and commands → Internal notifications → Tag names and values → Map element labels, map URL names and values → Script-type items and Browser-type items⁶ → Manual host action scripts⁶ → Manual event action scripts → <i>Description</i> parameter in <i>Item value</i> and <i>Gauge</i> widget → Primary/Secondary label <i>Text</i> parameter in <i>Honeycomb</i> widget → Column of data type <i>Text</i> in <i>Top hosts</i> widget 	<p><i>Software (Full details) field in host inventory.</i></p> <p>This macro may be used with a numeric index e.g. {INVENTORY.SOFTWARE.FULL<1-9>} to point to the first, second, third, etc. host in a trigger expression. See indexed macros.</p>
{INVENTORY.TAG}	<ul style="list-style-type: none"> → Trigger-based notifications and commands → Problem update notifications and commands → Internal notifications → Tag names and values → Map element labels, map URL names and values → Script-type items and Browser-type items⁶ → Manual host action scripts⁶ → Manual event action scripts → <i>Description</i> parameter in <i>Item value</i> and <i>Gauge</i> widget → Primary/Secondary label <i>Text</i> parameter in <i>Honeycomb</i> widget → Column of data type <i>Text</i> in <i>Top hosts</i> widget 	<p><i>Tag field in host inventory.</i></p> <p>This macro may be used with a numeric index e.g. {INVENTORY.TAG<1-9>} to point to the first, second, third, etc. host in a trigger expression. See indexed macros.</p> <p>{PROFILE.TAG<1-9>} is deprecated.</p>

Macro	Supported in	Description
{INVENTORY.TYPE}	<ul style="list-style-type: none"> → Trigger-based notifications and commands → Problem update notifications and commands → Internal notifications → Tag names and values → Map element labels, map URL names and values → Script-type items and Browser-type items⁶ → Manual host action scripts⁶ → Manual event action scripts → <i>Description</i> parameter in <i>Item value</i> and <i>Gauge</i> widget → Primary/Secondary label <i>Text</i> parameter in <i>Honeycomb</i> widget → Column of data type <i>Text</i> in <i>Top hosts</i> widget 	<p><i>Type field in host inventory.</i></p> <p>This macro may be used with a numeric index e.g. {INVENTORY.TYPE<1-9>} to point to the first, second, third, etc. host in a trigger expression. See indexed macros.</p> <p>{PROFILE.DEVICETYPE<1-9>} is deprecated.</p>
{INVENTORY.TYPE.FULL}	<ul style="list-style-type: none"> → Trigger-based notifications and commands → Problem update notifications and commands → Internal notifications → Tag names and values → Map element labels, map URL names and values → Script-type items and Browser-type items⁶ → Manual host action scripts⁶ → Manual event action scripts → <i>Description</i> parameter in <i>Item value</i> and <i>Gauge</i> widget → Primary/Secondary label <i>Text</i> parameter in <i>Honeycomb</i> widget → Column of data type <i>Text</i> in <i>Top hosts</i> widget 	<p><i>Type (Full details) field in host inventory.</i></p> <p>This macro may be used with a numeric index e.g. {INVENTORY.TYPE.FULL<1-9>} to point to the first, second, third, etc. host in a trigger expression. See indexed macros.</p>
{INVENTORY.URL.A}	<ul style="list-style-type: none"> → Trigger-based notifications and commands → Problem update notifications and commands → Internal notifications → Tag names and values → Map element labels, map URL names and values → Script-type items and Browser-type items⁶ → Manual host action scripts⁶ → Manual event action scripts → <i>Description</i> parameter in <i>Item value</i> and <i>Gauge</i> widget → Primary/Secondary label <i>Text</i> parameter in <i>Honeycomb</i> widget → Column of data type <i>Text</i> in <i>Top hosts</i> widget 	<p><i>URL A field in host inventory.</i></p> <p>This macro may be used with a numeric index e.g. {INVENTORY.URL.A<1-9>} to point to the first, second, third, etc. host in a trigger expression. See indexed macros.</p>
{INVENTORY.URL.B}	<ul style="list-style-type: none"> → Trigger-based notifications and commands → Problem update notifications and commands → Internal notifications → Tag names and values → Map element labels, map URL names and values → Script-type items and Browser-type items⁶ → Manual host action scripts⁶ → Manual event action scripts → <i>Description</i> parameter in <i>Item value</i> and <i>Gauge</i> widget → Primary/Secondary label <i>Text</i> parameter in <i>Honeycomb</i> widget → Column of data type <i>Text</i> in <i>Top hosts</i> widget 	<p><i>URL B field in host inventory.</i></p> <p>This macro may be used with a numeric index e.g. {INVENTORY.URL.B<1-9>} to point to the first, second, third, etc. host in a trigger expression. See indexed macros.</p>

Macro	Supported in	Description
{INVENTORY.URL.C}	<ul style="list-style-type: none"> → Trigger-based notifications and commands → Problem update notifications and commands → Internal notifications → Tag names and values → Map element labels, map URL names and values → Script-type items and Browser-type items⁶ → Manual host action scripts⁶ → Manual event action scripts → <i>Description</i> parameter in <i>Item value</i> and <i>Gauge</i> widget → Primary/Secondary label <i>Text</i> parameter in <i>Honeycomb</i> widget → Column of data type <i>Text</i> in <i>Top hosts</i> widget 	<p><i>URL C field in host inventory.</i></p> <p>This macro may be used with a numeric index e.g. {INVENTORY.URL.C<1-9>} to point to the first, second, third, etc. host in a trigger expression. See indexed macros.</p>
{INVENTORY.VENDOR}	<ul style="list-style-type: none"> → Trigger-based notifications and commands → Problem update notifications and commands → Internal notifications → Tag names and values → Map element labels, map URL names and values → Script-type items and Browser-type items⁶ → Manual host action scripts⁶ → Manual event action scripts → <i>Description</i> parameter in <i>Item value</i> and <i>Gauge</i> widget → Primary/Secondary label <i>Text</i> parameter in <i>Honeycomb</i> widget → Column of data type <i>Text</i> in <i>Top hosts</i> widget 	<p><i>Vendor field in host inventory.</i></p> <p>This macro may be used with a numeric index e.g. {INVENTORY.VENDOR<1-9>} to point to the first, second, third, etc. host in a trigger expression. See indexed macros.</p>

Items

Macro	Supported in	Description
{ITEM.DESCRPTION}	<ul style="list-style-type: none"> → Trigger-based notifications and commands → Problem update notifications and commands → Internal notifications → Manual event action scripts → <i>Description</i> parameter in <i>Item value</i> and <i>Gauge</i> widget → Primary/Secondary label <i>Text</i> parameter in <i>Honeycomb</i> widget 	<p><i>Description of the Nth item in the trigger expression that caused a notification.</i></p> <p>This macro may be used with a numeric index e.g. {ITEM.DESCRPTION<1-9>} to point to the first, second, third, etc. item in a trigger expression. See indexed macros.</p>
{ITEM.DESCRPTION.Orig}	<ul style="list-style-type: none"> → Trigger-based notifications and commands → Problem update notifications and commands → Internal notifications → Manual event action scripts → <i>Description</i> parameter in <i>Item value</i> and <i>Gauge</i> widget → Primary/Secondary label <i>Text</i> parameter in <i>Honeycomb</i> widget 	<p><i>Description (with macros unresolved) of the Nth item in the trigger expression that caused a notification.</i></p> <p>This macro may be used with a numeric index e.g. {ITEM.DESCRPTION.Orig<1-9>} to point to the first, second, third, etc. item in a trigger expression. See indexed macros.</p>

Macro	Supported in	Description
{ITEM.ID}	<ul style="list-style-type: none"> → Trigger-based notifications and commands → Problem update notifications and commands → Internal notifications → Script-type item and Browser-type item, item prototype and discovery rule parameter names and values → HTTP agent type item, item prototype and discovery rule fields: URL, Query fields, Request body, Headers, Proxy, SSL certificate file, SSL key file → Manual event action scripts → <i>Description</i> parameter in <i>Item value</i> and <i>Gauge</i> widget → Primary/Secondary label <i>Text</i> parameter in <i>Honeycomb</i> widget 	<p><i>Numeric ID of the Nth item in the trigger expression that caused a notification.</i></p> <p>This macro may be used with a numeric index e.g. {ITEM.ID<1-9>} to point to the first, second, third, etc. item in a trigger expression. See indexed macros.</p>
{ITEM.KEY}	<ul style="list-style-type: none"> → Trigger-based notifications and commands → Problem update notifications and commands → Internal notifications → Script-type item and Browser-type item, item prototype and discovery rule parameter names and values → HTTP agent type item, item prototype and discovery rule fields: URL, Query fields, Request body, Headers, Proxy, SSL certificate file, SSL key file → Manual event action scripts → <i>Description</i> parameter in <i>Item value</i> and <i>Gauge</i> widget → Primary/Secondary label <i>Text</i> parameter in <i>Honeycomb</i> widget 	<p><i>Key of the Nth item in the trigger expression that caused a notification.</i></p> <p>This macro may be used with a numeric index e.g. {ITEM.KEY<1-9>} to point to the first, second, third, etc. item in a trigger expression. See indexed macros.</p> <p>{TRIGGER.KEY} is deprecated.</p> <p>Macro functions are not supported for this macro if it is used as a placeholder in the first parameter of a history function, for example, <code>last (/ {HOST.HOST} / {ITEM.KEY})</code>.</p>
{ITEM.KEY.ORIG}	<ul style="list-style-type: none"> → Trigger-based notifications and commands → Problem update notifications and commands → Internal notifications → Script-type item and Browser-type item, item prototype and discovery rule parameter names and values → HTTP agent type item, item prototype and discovery rule fields: URL, Query fields, Request body, Headers, Proxy, SSL certificate file, SSL key file → Manual event action scripts → <i>Description</i> parameter in <i>Item value</i> and <i>Gauge</i> widget → Primary/Secondary label <i>Text</i> parameter in <i>Honeycomb</i> widget 	<p><i>Original key (with macros not expanded) of the Nth item in the trigger expression that caused a notification⁴.</i></p> <p>This macro may be used with a numeric index e.g. {ITEM.KEY.ORIG<1-9>} to point to the first, second, third, etc. item in a trigger expression. See indexed macros.</p>

Macro	Supported in	Description
{ITEM.LASTVALUE}	<ul style="list-style-type: none"> → Trigger-based notifications and commands → Problem update notifications and commands → Trigger names, event names, operational data and descriptions → Tag names and values → Trigger URLs → Manual event action scripts → <i>Description</i> parameter in <i>Item value</i> and <i>Gauge</i> widget → Primary/Secondary label <i>Text</i> parameter in <i>Honeycomb</i> widget 	<p><i>The latest value of the Nth item in the trigger expression that caused a notification.</i></p> <p>It will resolve to *UNKNOWN* in the frontend if the latest history value has been collected more than the <i>Max history display period</i> time ago (set in the Administration→General menu section).</p> <p>When used in the problem name, the macro will not resolve to the latest item value when viewing problem events; instead, it will keep the item value from the time when the problem happened.</p> <p>When used in notifications, in some cases the macro might not resolve to the latest item value at the moment the trigger fired. For example, if an item quickly receives two values, "A" and "B", and the trigger fires for "A", notifications might show "B" as the latest value due to a slight processing delay - the latest item value changed between the time the trigger fired and when the notification was created. To avoid this, you can use the {ITEM.VALUE} macro, which resolves to the value at the moment the trigger fires, ensuring the correct value is used in the notification.</p> <p>It is alias to <code>last (/ {HOST.HOST} / {ITEM.KEY})</code>.</p> <p>The resolved value for text/log items is truncated to 20 characters by the frontend in the following locations:</p> <ul style="list-style-type: none"> - Operational data; - Trigger description; - Trigger URLs; - Trigger URL labels; - Description of the item value widget. <p>To resolve to a full value, you may use macro functions, as no values are truncated by the server. For example: <code>{{ITEM.LASTVALUE}}.regsub("(.*)", \1)</code></p> <p>This macro may be used with a numeric index e.g. {ITEM.LASTVALUE<1-9>} to point to the first, second, third, etc. item in a trigger expression. See indexed macros.</p>
{ITEM.LOG.AGE}	<ul style="list-style-type: none"> → Trigger-based notifications and commands → Problem update notifications and commands → Trigger names, operational data and descriptions → Trigger URLs → Event tags and values → Manual event action scripts → <i>Description</i> parameter in <i>Item value</i> widget → Primary/Secondary label <i>Text</i> parameter in <i>Honeycomb</i> widget 	<p><i>Age of the log event, with precision down to a second.</i></p> <p>This macro may be used with a numeric index e.g. {ITEM.LOG.AGE<1-9>} to point to the first, second, third, etc. item in a trigger expression. See indexed macros.</p>

Macro	Supported in	Description
{ITEM.LOG.DATE}	<ul style="list-style-type: none"> → Trigger-based notifications and commands → Problem update notifications and commands → Trigger names, operational data and descriptions → Trigger URLs → Event tags and values → Manual event action scripts → <i>Description</i> parameter in <i>Item value</i> widget → Primary/Secondary label <i>Text</i> parameter in <i>Honeycomb</i> widget 	<p><i>Date when the log entry was written to the log.</i></p> <p>This macro may be used with a numeric index e.g. {ITEM.LOG.DATE<1-9>} to point to the first, second, third, etc. item in a trigger expression. See indexed macros.</p>
{ITEM.LOG.EVENTID}	<ul style="list-style-type: none"> → Trigger-based notifications and commands → Problem update notifications and commands → Trigger names, operational data and descriptions → Trigger URLs → Event tags and values → Manual event action scripts → <i>Description</i> parameter in <i>Item value</i> widget → Primary/Secondary label <i>Text</i> parameter in <i>Honeycomb</i> widget 	<p><i>ID of the event in the event log.</i></p> <p>For Windows event log monitoring only.</p> <p>This macro may be used with a numeric index e.g. {ITEM.LOG.EVENTID<1-9>} to point to the first, second, third, etc. item in a trigger expression. See indexed macros.</p>
{ITEM.LOG.NSEVERITY}	<ul style="list-style-type: none"> → Trigger-based notifications and commands → Problem update notifications and commands → Trigger names, operational data and descriptions → Trigger URLs → Event tags and values → Manual event action scripts → <i>Description</i> parameter in <i>Item value</i> widget → Primary/Secondary label <i>Text</i> parameter in <i>Honeycomb</i> widget 	<p><i>Numeric severity of the event in the event log.</i></p> <p>For Windows event log monitoring only.</p> <p>This macro may be used with a numeric index e.g. {ITEM.LOG.NSEVERITY<1-9>} to point to the first, second, third, etc. item in a trigger expression. See indexed macros.</p>
{ITEM.LOG.SEVERITY}	<ul style="list-style-type: none"> → Trigger-based notifications and commands → Problem update notifications and commands → Trigger names, operational data and descriptions → Trigger URLs → Event tags and values → Manual event action scripts → <i>Description</i> parameter in <i>Item value</i> widget → Primary/Secondary label <i>Text</i> parameter in <i>Honeycomb</i> widget 	<p><i>Verbal severity of the event in the event log.</i></p> <p>For Windows event log monitoring only.</p> <p>This macro may be used with a numeric index e.g. {ITEM.LOG.SEVERITY<1-9>} to point to the first, second, third, etc. item in a trigger expression. See indexed macros.</p>
{ITEM.LOG.SOURCE}	<ul style="list-style-type: none"> → Trigger-based notifications and commands → Problem update notifications and commands → Trigger names, operational data and descriptions → Trigger URLs → Event tags and values → Manual event action scripts → <i>Description</i> parameter in <i>Item value</i> widget → Primary/Secondary label <i>Text</i> parameter in <i>Honeycomb</i> widget 	<p><i>Source of the event in the event log.</i></p> <p>For Windows event log monitoring only.</p> <p>This macro may be used with a numeric index e.g. {ITEM.LOG.SOURCE<1-9>} to point to the first, second, third, etc. item in a trigger expression. See indexed macros.</p>
{ITEM.LOG.TIME}	<ul style="list-style-type: none"> → Trigger-based notifications and commands → Problem update notifications and commands → Trigger names, operational data and descriptions → Trigger URLs → Event tags and values → Manual event action scripts → <i>Description</i> parameter in <i>Item value</i> widget → Primary/Secondary label <i>Text</i> parameter in <i>Honeycomb</i> widget 	<p><i>Time when the log entry was written to the log.</i></p> <p>This macro may be used with a numeric index e.g. {ITEM.LOG.TIME<1-9>} to point to the first, second, third, etc. item in a trigger expression. See indexed macros.</p>

Macro	Supported in	Description
{ITEM.LOG.TIMESTAMP}	<ul style="list-style-type: none"> → Trigger-based notifications and commands → Problem update notifications and commands → Trigger names, operational data and descriptions → Trigger URLs → Event tags and values → Manual event action <i>scripts</i> → <i>Description</i> parameter in <i>Item value</i> widget → Primary/Secondary label <i>Text</i> parameter in <i>Honeycomb</i> widget 	<p><i>Unix timestamp when the log entry was written to the log.</i></p> <p>This macro may be used with a numeric index e.g. {ITEM.LOG.TIMESTAMP<1-9>} to point to the first, second, third, etc. item in a trigger expression. See <i>indexed macros</i>.</p>
{ITEM.NAME}	<ul style="list-style-type: none"> → Trigger-based notifications and commands → Problem update notifications and commands → Internal notifications → Manual event action <i>scripts</i> → <i>Description</i> parameter in <i>Item value</i> and <i>Gauge</i> widget → Primary/Secondary label <i>Text</i> parameter in <i>Honeycomb</i> widget 	<p><i>Name of the item with all macros resolved.</i></p> <p>This macro may be used with a numeric index e.g. {ITEM.NAME<1-9>} to point to the first, second, third, etc. item in a trigger expression. See <i>indexed macros</i>.</p>
{ITEM.NAME.ORIG}	<ul style="list-style-type: none"> → Trigger-based notifications and commands → Problem update notifications and commands → Internal notifications → Manual event action <i>scripts</i> → <i>Description</i> parameter in <i>Item value</i> and <i>Gauge</i> widget → Primary/Secondary label <i>Text</i> parameter in <i>Honeycomb</i> widget 	<p>This macro is used to resolve to the <i>original name (i.e. without macros resolved) of the item.</i></p> <p>This macro may be used with a numeric index e.g. {ITEM.NAME.ORIG<1-9>} to point to the first, second, third, etc. item in a trigger expression. See <i>indexed macros</i>.</p>
{ITEM.STATE}	<ul style="list-style-type: none"> → Item-based internal notifications → <i>Description</i> parameter in <i>Item value</i> and <i>Gauge</i> widget → Primary/Secondary label <i>Text</i> parameter in <i>Honeycomb</i> widget 	<p><i>The latest state of the Nth item in the trigger expression that caused a notification. Possible values: Not supported and Normal.</i></p> <p>This macro may be used with a numeric index e.g. {ITEM.STATE<1-9>} to point to the first, second, third, etc. item in a trigger expression. See <i>indexed macros</i>.</p>
{ITEM.STATE.ERROR}	<ul style="list-style-type: none"> → Item-based internal notifications 	<p><i>Error message with details why an item became unsupported.</i></p> <p>If an item goes into the unsupported state and then immediately gets supported again the error field can be empty.</p>

Macro	Supported in	Description
{ITEM.VALUE}	<ul style="list-style-type: none"> → Trigger-based notifications and commands → Problem update notifications and commands → Trigger names, event names, operational data and descriptions → Tag names and values → Trigger URLs → Manual event action scripts → <i>Description</i> parameter in <i>Item value</i> and <i>Gauge</i> widget → Primary/Secondary label <i>Text</i> parameter in <i>Honeycomb</i> widget 	<p>Resolved to either:</p> <ol style="list-style-type: none"> 1) the historical (at-the-time-of-event) value of the Nth item in the trigger expression, if used in the context of trigger status change, for example, when displaying events or sending notifications. 2) the latest value of the Nth item in the trigger expression, if used without the context of trigger status change, for example, when displaying a list of triggers in a pop-up selection window. In this case works the same as {ITEM.LASTVALUE} <p>In the first case it will resolve to *UNKNOWN* if the history value has already been deleted or has never been stored.</p> <p>In the second case, and in the frontend only, it will resolve to *UNKNOWN* if the latest history value has been collected more than the <i>Max history display period</i> time ago (set in the Administration→General menu section).</p> <p>The resolved value for text/log items is truncated to 20 characters by the frontend in the following locations:</p> <ul style="list-style-type: none"> - Operational data; - Trigger description; - Trigger URLs; - Trigger URL labels; - Description of the item value widget. <p>To resolve to a full value, you may use macro functions, as no values are truncated by the server. For example: <code>{{ITEM.VALUE}.regsub("(.*)", \1)}</code></p> <p>This macro may be used with a numeric index e.g. {ITEM.VALUE<1-9>} to point to the first, second, third, etc. item in a trigger expression. See indexed macros.</p>
{ITEM.VALUETYPE}	<ul style="list-style-type: none"> → Trigger-based notifications and commands → Problem update notifications and commands → Internal notifications → Manual event action scripts → <i>Description</i> parameter in <i>Item value</i> and <i>Gauge</i> widget → Primary/Secondary label <i>Text</i> parameter in <i>Honeycomb</i> widget 	<p><i>Value type of the Nth item in the trigger expression that caused a notification.</i> Possible values: 0 - numeric float, 1 - character, 2 - log, 3 - numeric unsigned, 4 - text.</p> <p>This macro may be used with a numeric index e.g. {ITEM.VALUETYPE<1-9>} to point to the first, second, third, etc. item in a trigger expression. See indexed macros.</p>

Low-level discovery rules

Macro	Supported in	Description
{LLDRULE.DESCRPTION}	→ LLD-rule based internal notifications	<i>Description of the low-level discovery rule which caused a notification.</i>
{LLDRULE.DESCRPTION_ORIG}	→ LLD-rule based internal notifications	<i>Description (with macros unresolved) of the low-level discovery rule which caused a notification.</i>
{LLDRULE.ID}	→ LLD-rule based internal notifications	<i>Numeric ID of the low-level discovery rule which caused a notification.</i>
{LLDRULE.KEY}	→ LLD-rule based internal notifications	<i>Key of the low-level discovery rule which caused a notification.</i>
{LLDRULE.KEY_ORIG}	→ LLD-rule based internal notifications	<i>Original key (with macros not expanded) of the low-level discovery rule which caused a notification.</i>

Macro	Supported in	Description
{LLDRULE.NAME}	LLD-rule based internal notifications	<i>Name of the low-level discovery rule (with macros resolved) that caused a notification.</i>
{LLDRULE.NAME-ORIG}	rule based internal notifications	<i>Original name (i.e. without macros resolved) of the low-level discovery rule that caused a notification.</i>
{LLDRULE.STATE}	LLD-rule based internal notifications	<i>The latest state of the low-level discovery rule.</i> Possible values: Not supported and Normal .
{LLDRULE.STATE-ERROR}	rule based internal notifications	<i>Error message with details why an LLD rule became unsupported.</i>

If an LLD rule goes into the unsupported state and then immediately gets supported again the error field can be empty.

Maps

Macro	Supported in	Description
{MAP.ID}	→ Map element labels, map URL names and values	<i>Network map ID.</i>
{MAP.NAME}	→ Map element labels, map URL names and values → Text field in map shapes	<i>Network map name.</i>

Proxies

Macro	Supported in	Description
{PROXY.DESCRPTION}	<ul style="list-style-type: none"> → Trigger-based notifications and commands → Problem update notifications and commands → Discovery notifications and commands → Autoregistration notifications and commands → Internal notifications → Manual event action scripts 	<p><i>Description of the proxy.</i> Resolves to either:</p> <ol style="list-style-type: none"> 1) proxy of the Nth item in the trigger expression (in trigger-based notifications). You may use indexed macros here. 2) proxy, which executed discovery (in discovery notifications). Use {PROXY.DESCRPTION} here, without indexing. 3) proxy to which an active agent registered (in autoregistration notifications). Use {PROXY.DESCRPTION} here, without indexing. <p>This macro may be used with a numeric index e.g. {PROXY.DESCRPTION<1-9>} to point to the first, second, third, etc. item in a trigger expression. See indexed macros.</p>
{PROXY.NAME}	<ul style="list-style-type: none"> → Trigger-based notifications and commands → Problem update notifications and commands → Discovery notifications and commands → Autoregistration notifications and commands → Internal notifications → Manual event action scripts 	<p><i>Name of the proxy.</i> Resolves to either:</p> <ol style="list-style-type: none"> 1) proxy of the Nth item in the trigger expression (in trigger-based notifications). You may use indexed macros here. 2) proxy, which executed discovery (in discovery notifications). Use {PROXY.NAME} here, without indexing. 3) proxy to which an active agent registered (in autoregistration notifications). Use {PROXY.NAME} here, without indexing. <p>This macro may be used with a numeric index e.g. {PROXY.NAME<1-9>} to point to the first, second, third, etc. item in a trigger expression. See indexed macros.</p>

Scripts

Macro	Supported in	Description
{MANUALINPUT}	<ul style="list-style-type: none"> → Manual host action scripts, confirmation text, and URL field in URL scripts → Manual event action scripts, confirmation text, and URL field in URL scripts 	<i>Manual input value</i> specified by user at script execution time.

Services

Macro	Supported in	Description
{SERVICE.DESCRPTION}	<ul style="list-style-type: none"> → Service-based notifications and commands → Service update notifications and commands 	<i>Description of the service</i> (with macros resolved).
{SERVICE.ID}	<ul style="list-style-type: none"> → Service-based notifications and commands → Service update notifications and commands 	<i>Numeric ID of the service that triggered an action.</i>
{SERVICE.NAME}	<ul style="list-style-type: none"> → Service-based notifications and commands → Service update notifications and commands 	<i>Name of the service</i> (with macros resolved).
{SERVICE.ROOTCAUSE}	<ul style="list-style-type: none"> → Service-based notifications and commands → Service update notifications and commands 	<i>List of trigger problem events that caused a service to fail</i> , sorted by severity and host name. Includes the following details: host name, event name, severity, age, service tags and values.
{SERVICE.TAGS}	<ul style="list-style-type: none"> → Service-based notifications and commands → Service update notifications and commands 	<i>A comma separated list of service event tags.</i> Service event tags can be defined in the service configuration section Tags. Expanded to an empty string if no tags exist.
{SERVICE.TAGSJSON}	<ul style="list-style-type: none"> → Service-based notifications and commands → Service update notifications and commands 	<i>A JSON array containing service event tag objects.</i> Service event tags can be defined in the service configuration section Tags. Expanded to an empty array if no tags exist.
{SERVICE.TAGS.<tag name>}	<ul style="list-style-type: none"> → Service-based notifications and commands → Service update notifications and commands 	<i>Service event tag value referenced by the tag name.</i> Service event tags can be defined in the service configuration section Tags. A tag name containing non-alphanumeric characters (including non-English multibyte-UTF characters) should be double quoted. Quotes and backslashes inside a quoted tag name must be escaped with a backslash.

Triggers

Macro	Supported in	Description
{TRIGGER.DESCRPTION}	<ul style="list-style-type: none"> → Trigger-based notifications and commands → Problem update notifications and commands → Trigger-based internal notifications → Manual event action scripts 	<i>Trigger description.</i> All macros supported in a trigger description will be expanded if {TRIGGER.DESCRPTION} is used in notification text. {TRIGGER.COMMENT} is deprecated.
{TRIGGER.EXPRESSION}	<ul style="list-style-type: none"> → Trigger-based notifications and commands → Problem update notifications and commands → Manual event action scripts → Event names 	<i>Partially evaluated trigger expression.</i> Item-based functions are evaluated and replaced by the results at the time of event generation whereas all other functions are displayed as written in the expression. Can be used for debugging trigger expressions.
{TRIGGER.EXPRESSION.RECOVERY}	<ul style="list-style-type: none"> → Trigger-based notifications and commands → Problem update notifications and commands → Manual event action scripts 	<i>Partially evaluated trigger recovery expression.</i> Item-based functions are evaluated and replaced by the results at the time of event generation whereas all other functions are displayed as written in the expression. Can be used for debugging trigger recovery expressions.
{TRIGGER.EVENTS.ACK}	<ul style="list-style-type: none"> → Trigger-based notifications and commands → Problem update notifications and commands → Map element labels → Manual event action scripts 	<i>Number of acknowledged events for a map element in maps, or for the trigger which generated current event in notifications.</i>

Macro	Supported in	Description
{TRIGGER.EVENTS.PROBLEM.ACK}	Trigger-based notifications and commands → Problem update notifications and commands → Map element labels → Manual event action scripts	Number of acknowledged PROBLEM events for all triggers disregarding their state.
{TRIGGER.EVENTS.PROBLEM.UNACK}	Trigger-based notifications and commands → Problem update notifications and commands → Map element labels → Manual event action scripts	Number of unacknowledged PROBLEM events for all triggers disregarding their state.
{TRIGGER.EVENTS.UNACK}	Trigger-based notifications and commands → Problem update notifications and commands → Map element labels → Manual event action scripts	Number of unacknowledged events for a map element in maps, or for the trigger which generated current event in notifications.
{TRIGGER.HOSTGROUPS}	Trigger-based notifications and commands → Problem update notifications and commands → Trigger-based internal notifications → Manual event action scripts	A sorted (by SQL query), comma-space separated list of host groups in which the trigger is defined.
{TRIGGER.PROBLEM.EVENTS.PROBLEM.ACK}	Trigger-based notifications and commands	Number of acknowledged PROBLEM events for triggers in PROBLEM state.
{TRIGGER.PROBLEM.EVENTS.PROBLEM.UNACK}	Trigger-based notifications and commands	Number of unacknowledged PROBLEM events for triggers in PROBLEM state.
{TRIGGER.EXPRESSION}	Trigger-based notifications and commands → Problem update notifications and commands → Trigger-based internal notifications → Manual event action scripts	Trigger expression.
{TRIGGER.EXPRESSION.RECOVERY}	Trigger-based notifications and commands → Problem update notifications and commands → Trigger-based internal notifications → Manual event action scripts	Trigger recovery expression if OK event generation in trigger configuration is set to 'Recovery expression'; otherwise an empty string is returned.
{TRIGGER.ID}	Trigger-based notifications and commands → Problem update notifications and commands → Trigger-based internal notifications → Map element labels, map URL names and values → Trigger URLs → Trigger tag value → Manual event action scripts	Numeric trigger ID which triggered this action. Supported in trigger tag values.
{TRIGGER.NAME}	Trigger-based notifications and commands → Problem update notifications and commands → Trigger-based internal notifications → Manual event action scripts	Name of the trigger (with macros resolved). Note that since 4.0.0 {EVENT.NAME} can be used in actions to display the triggered event/problem name with macros resolved.
{TRIGGER.NAME.ORIGINAL}	Trigger-based notifications and commands → Problem update notifications and commands → Trigger-based internal notifications → Manual event action scripts	Original name of the trigger (i.e. without macros resolved).
{TRIGGER.NSEVERITY}	Trigger-based notifications and commands → Problem update notifications and commands → Trigger-based internal notifications → Manual event action scripts	Numerical trigger severity. Possible values: 0 - Not classified, 1 - Information, 2 - Warning, 3 - Average, 4 - High, 5 - Disaster.
{TRIGGER.SEVERITY}	Trigger-based notifications and commands → Problem update notifications and commands → Trigger-based internal notifications → Manual event action scripts	Trigger severity name. Can be defined in Administration → General → Trigger displaying options.
{TRIGGER.STATE}	Trigger-based internal notifications	The latest state of the trigger. Possible values: Unknown and Normal .
{TRIGGER.STATE.ERROR}	Trigger-based internal notifications	Error message with details why a trigger became unsupported. If a trigger goes into the unsupported state and then immediately gets supported again the error field can be empty.
{TRIGGER.STATUS}	Trigger-based notifications and commands → Problem update notifications and commands → Manual event action scripts	Trigger value at the time of operation step execution. Can be either PROBLEM or OK. {STATUS} is deprecated.

Macro	Supported in	Description
{TRIGGER.TEMPLATE}	Trigger-based notifications and commands → Problem update notifications and commands → Trigger-based internal notifications → Manual event action scripts	<i>A sorted (by SQL query), comma-space separated list of templates in which the trigger is defined, or *UNKNOWN* if the trigger is defined in a host.</i>
{TRIGGER.URL}	Trigger-based notifications and commands → Problem update notifications and commands → Trigger-based internal notifications → Manual event action scripts	<i>Trigger URL.</i>
{TRIGGER.URL.NAME}	Trigger-based notifications and commands → Problem update notifications and commands → Trigger-based internal notifications → Manual event action scripts	<i>The label for the trigger URL.</i>
{TRIGGER.VALUE}	Trigger-based notifications and commands → Problem update notifications and commands → Trigger expressions → Manual event action scripts	<i>Current trigger numeric value: 0 - trigger is in OK state, 1 - trigger is in PROBLEM state.</i>
{TRIGGERS.UNACK}	Map element labels	<i>Number of unacknowledged triggers for a map element, disregarding trigger state. A trigger is considered to be unacknowledged if at least one of its PROBLEM events is unacknowledged.</i>
{TRIGGERS.PROBLEMUNACK}	Map element labels	<i>Number of unacknowledged PROBLEM triggers for a map element. A trigger is considered to be unacknowledged if at least one of its PROBLEM events is unacknowledged.</i>
{TRIGGERS.ACK}	Map element labels	<i>Number of acknowledged triggers for a map element, disregarding trigger state. A trigger is considered to be acknowledged if all of it's PROBLEM events are acknowledged.</i>
{TRIGGERS.PROBLEMACK}	Map element labels	<i>Number of acknowledged PROBLEM triggers for a map element. A trigger is considered to be acknowledged if all of it's PROBLEM events are acknowledged.</i>

Users

Macro	Supported in	Description
{USER.FULLNAME}	Problem update notifications and commands → Manual host action scripts (including confirmation text) → Manual event action scripts (including confirmation text)	<i>Name, surname and username of the user who added event acknowledgment or started the script.</i>
{USER.NAME}	→ Manual host action scripts (including confirmation text) → Manual event action scripts (including confirmation text)	<i>Name of the user who started the script.</i>
{USER.SURNAME}	Manual host action scripts (including confirmation text) → Manual event action scripts (including confirmation text)	<i>Surname of the user who started the script.</i>
{USER.USERNAME}	Manual host action scripts (including confirmation text) → Manual event action scripts (including confirmation text)	<i>Username of the user who started the script. {USER.ALIAS}, supported before Zabbix 5.4.0, is now deprecated.</i>

Other macro types

Macro	Supported in	Description
{ \$MACRO }	→ See: User macros supported by location	<i>User-definable macros.</i>

Macro	Supported in	Description
{#MACRO}	→ See: Low-level discovery macros	<i>Low-level discovery macros.</i>
{?EXPRESSION}	→ Trigger event names → Trigger-based notifications and commands → Problem update notifications and commands → Script commands and their webhook parameters → Map element labels ³ → Map shape labels ³ → Link labels in maps ³ → Graph names ⁵	See expression macros .
\$1...\$9	→ Trigger names → User parameter commands	<i>Positional macros/references.</i>

Footnotes

¹ The {HOST.*} macros supported in item key parameters will resolve to the interface that is selected for the item. When used in items without interfaces they will resolve to either the Zabbix agent, SNMP, JMX or IPMI interface of the host in this order of priority or to 'UNKNOWN' if the host does not have any interface.

² In global scripts, interface IP/DNS fields and web scenarios the macro will resolve to the main agent interface. If an agent interface is not defined, the main SNMP interface will be used. If an SNMP interface is also not defined, the main JMX interface will be used. If a JMX interface is not defined either, the main IPMI interface will be used. If the host does not have any interface, the macro resolves to 'UNKNOWN'.

³ Only the **avg**, **last**, **max** and **min** functions, with seconds as parameter are supported in this macro in map labels.

⁴ {HOST.*} macros are supported in web scenario *Variables*, *Headers*, *SSL certificate file* and *SSL key file* fields and in scenario step *URL*, *Post*, *Headers* and *Required string* fields. Since Zabbix 5.2.2, {HOST.*} macros are no longer supported in web scenario *Name* and web scenario step *Name* fields.

⁵ Only the **avg**, **last**, **max** and **min** functions, with seconds as parameter are supported within this macro in graph names. The {HOST.HOST<1-9>} macro can be used as host within the macro. For example:

```
last(/Cisco switch/ifAlias[{-#SNMPINDEX}])
last(/{HOST.HOST}/ifAlias[{-#SNMPINDEX}])
```

⁶ Supported in Script-type items and Browser-type items and manual host action scripts for Zabbix server and Zabbix proxy.

Indexed macros

The indexed macro syntax of {MACRO<1-9>} works only in the context of **trigger expressions**. It can be used to reference hosts or functions in the order in which they appear in the expression. Macros like {HOST.IP1}, {HOST.IP2}, {HOST.IP3} will resolve to the IP of the first, second, and third host in the trigger expression (providing the trigger expression contains those hosts). Macros like {FUNCTION.VALUE1}, {FUNCTION.VALUE2}, {FUNCTION.VALUE3} will resolve to the value of the first, second, and third item-based function in the trigger expression at the time of the event (providing the trigger expression contains those functions).

Additionally the {HOST.HOST<1-9>} macro is also supported within the {?func(/host/key,param)} expression macro in **graph names**. For example, {?func(/{HOST.HOST2}/key,param)} in the graph name will refer to the host of the second item in the graph.

Warning:

Indexed macros will not resolve in any other context, except the two cases mentioned here. For other contexts, use macros **without** index (i. e. {HOST.HOST}, {HOST.IP}, etc) instead.

2 User macros supported by location

Overview

This section contains a list of locations, where **user-definable** macros are supported.

Note:

Only global-level user macros are supported for *Actions*, *Network discovery*, *Proxies* and all locations listed under *Other locations* section of this page. In the mentioned locations, host-level and template-level macros will not be resolved.

Note:

To customize macro values (for example, shorten or extract specific substrings), you can use **macro functions**.

Actions

In **actions**, user macros can be used in the following fields:

Location	Multiple macros/mix with text ¹
Trigger-based notifications and commands	yes
Trigger-based internal notifications	yes
Problem update notifications	yes
Service-based notifications and commands	yes
Service update notifications	yes
Time period condition	no
<i>Operations</i>	
Default operation step duration	no
Step duration	no

Hosts/host prototypes

In a **host** and **host prototype** configuration, user macros can be used in the following fields:

Location	Multiple macros/mix with text ¹
Interface IP/DNS	DNS only
Interface port	no
<i>SNMP v1, v2</i>	
SNMP community	yes
<i>SNMP v3</i>	
Context name	yes
Security name	yes
Authentication passphrase	yes
Privacy passphrase	yes
<i>IPMI</i>	
Username	yes
Password	yes
<i>Tags²</i>	
Tag names	yes
Tag values	yes

Items / item prototypes

In an **item** or an **item prototype** configuration, user macros can be used in the following fields:

Location	Multiple macros/mix with text ¹
Item name	yes
Item key parameters	yes
Update interval	no

Location	Multiple macros/mix with text ¹
Custom	no
in- ter- vals	
Timeout (avail- able for sup- ported item types)	no
Store up to (for his- tory and trends)	no
Description <i>Calculated/aggregate item</i>	yes
Formula (expression constants and function parameters; item key parameters; (<i>aggregate item only</i>) filter conditions (host group name and tag name))	yes
<i>Database</i>	
<i>mon- i- tor</i>	
Username	yes
Password	yes
SQL query	yes
<i>HTTP</i>	
<i>agent</i>	
URL ³	yes
Query fields	yes
Request body	yes
Headers (names and values)	yes
Required status codes	yes
HTTP proxy	yes
HTTP authentication username	yes
HTTP authentication password	yes
SSI certificate file	yes
SSI key file	yes
SSI key password	yes
Allowed hosts	yes
<i>JMX</i>	
<i>agent</i>	
JMX endpoint	yes
<i>Script</i>	
<i>item</i>	
Parameter names and values	yes
<i>Browser</i>	
<i>item</i>	
Parameter names and values	yes
<i>SNMP</i>	
<i>agent</i>	
SNMP OID	yes
<i>SSH</i>	
<i>agent</i>	
Username	yes

Location	Multiple macros/mix with text ¹
Public key file	yes
Private key file	yes
Password	yes
Script	yes
<i>TELNET agent</i>	
Username	yes
Password	yes
Script	yes
<i>Zabbix trap-per</i>	
Allowed hosts	yes
<i>Tags²</i>	
Tag names	yes
Tag values	yes
<i>Preprocessing steps</i>	
Parameters (including custom scripts)	yes
Custom error-handling parameters (<i>Set value to</i> and <i>Set error to</i> fields)	yes

Low-level discovery

In a **low-level discovery rule**, user macros can be used in the following fields:

Location	Multiple macros/mix with text ¹
Key parameters	yes
Update interval	no
Custom interval	no
Timeout (available for supported item types)	no
Delete lost resources	no
Disable lost resources	no
Description	yes
<i>SNMP agent</i>	
SNMP OID	yes
<i>SSH agent</i>	
Username	yes
Public key file	yes
Private key file	yes
Password	yes
Script	yes
<i>TELNET agent</i>	
Username	yes
Password	yes
Script	yes
<i>Zabbix trapper</i>	
Allowed hosts	yes
<i>Database monitor</i>	
Username	yes
Password	yes
SQL query	yes
<i>JMX agent</i>	
JMX endpoint	yes
<i>HTTP agent</i>	
URL ³	yes
Query fields	yes
Request body	yes
Headers (names and values)	yes
Required status codes	yes
HTTP authentication username	yes

Location		Multiple macros/mix with text ¹
<i>Filters</i>	HTTP authentication password	yes
	Regular expression	yes
<i>Overrides</i>	Filters: regular expression	yes
	Operations: update interval (for item prototypes)	no
	Operations: history storage period (for item prototypes)	no
	Operations: trend storage period (for item prototypes)	no

Network discovery

In a **network discovery rule**, user macros can be used in the following fields:

Location		Multiple macros/mix with text ¹
Update interval		no
<i>SNMP v1, v2</i>	SNMP community	yes
	SNMP OID	yes
<i>SNMP v3</i>	Context name	yes
	Security name	yes
	Authentication passphrase	yes
	Privacy passphrase	yes
	SNMP OID	yes

Proxies

In a **proxy** configuration, user macros can be used in the following fields:

Location		Multiple macros/mix with text ¹
Interface port (for active agents, if proxy belongs to group)		no
Interface port (for passive proxy)		no
Timeouts for item types		no

Proxy groups

In a **proxy group** configuration, user macros can be used in the following fields:

Location		Multiple macros/mix with text ¹
Failover period		no
Minimum number of proxies		no

Templates

In a **template** configuration, user macros can be used in the following fields:

Location		Multiple macros/mix with text ¹
<i>Tags²</i>	Tag names	yes
	Tag values	yes

Triggers

In a **trigger** configuration, user macros can be used in the following fields:

Location	Multiple macros/mix with text ¹
Name	yes
Operational data	yes
Expression (only in constants and function parameters; secret macros are not supported)	yes
Tag for matching	yes
Menu entry name	yes
Menu entry URL ³	yes
Description	yes
<i>Tags</i> ²	
Tag names	yes
Tag values	yes

Web scenario

In a **web scenario** configuration, user macros can be used in the following fields:

Location	Multiple macros/mix with text ¹
Name	yes
Update interval	no
Agent	yes
HTTP proxy	yes
Variables (values only)	yes
Headers (names and values)	yes
<i>Steps</i>	
Name	yes
URL ³	yes
Variables (values only)	yes
Headers (names and values)	yes
Timeout	no
Required string	yes
Required status codes	no
<i>Authentication</i>	
User	yes

Location		Multiple macros/mix with text ¹
Tags ²	Password	yes
	SSL certificate	yes
	SSL key file	yes
	SSL key password	yes
	Tag names	yes
	Tag values	yes

Other locations

In addition to the locations listed here, user macros can be used in the following fields:

Location	Multiple macros/mix with text ¹
Global scripts (URL, script, SSH, Telnet, IPMI), including configuration text	yes
Webhooks	
JavaScript script	no
JavaScript script parameter name	no
JavaScript script parameter value	yes
<i>Dashboards</i>	
Column of data type <i>Text</i> in <i>Top hosts</i> dashboard widget	yes
<i>Description</i> parameter in <i>Item value</i> and <i>Gauge</i> dashboard widget	yes
Primary/Secondary label <i>Text</i> parameter in <i>Honeycomb</i> dashboard widget	yes
URL ³ parameter in <i>URL</i> dashboard widget	yes
<i>Users</i>	
→ <i>Users</i>	
→ <i>Media</i>	
When active	no
<i>Administration</i>	
→ <i>General</i>	
→ <i>GUI</i>	
Working time	no
<i>Administration</i>	
→ <i>General</i>	
→ <i>Timeouts</i>	
Timeouts for item types	no

Location	Multiple macros/mix with text ¹
<i>Administration</i>	
→	
<i>General</i>	
→	
<i>Connectors</i>	
URL	yes
Username	yes
Password	yes
Bearer token	yes
Timeout	no
HTTP proxy	yes
SSL certificate file	yes
SSL key file	yes
SSL key password	yes
<i>Alerts</i>	
→	
<i>Media types</i>	
→	
<i>Message templates</i>	
Subject	yes
Message	yes
<i>Alerts</i>	
→	
<i>Media types</i>	
→	
<i>Script</i>	
Script parameters	yes
<i>Alerts</i>	
→	
<i>Media types</i>	
→	
<i>Media type</i>	
<i>Username</i> and <i>Password</i> fields for the <i>Email</i> media type (when <i>Authentication</i> is set to "Username and password"; secret macros recommended)	yes

For a complete list of all macros supported in Zabbix, see [supported macros](#).

Footnotes

- ¹ If multiple macros in a field or macros mixed with text are not supported for the location, a single macro has to fill the whole field.
- ² Macros used in tag names and values are resolved only during event generation process.
- ³ URLs that contain a **secret macro** will not work, as the macro in them will be resolved as "*****".

7 Unit symbols

Overview

Working with large values such as "86400", "104857600", or "1000000" can be challenging and can lead to errors. Therefore, Zabbix supports unit symbols (suffixes) that function as value multipliers.

The use of suffixes can simplify, for example, the configuration of trigger expressions, making them easier to understand and maintain.

Trigger expressions without suffixes:

```
last(/host/system.uptime)<86400
avg(/host/system.cpu.load,600s)<10
last(/host/vm.memory.size[available])<20971520
```

Trigger expressions with suffixes:

```
last(/host/system.uptime)<1d
avg(/host/system.cpu.load,10m)<10
last(/host/vm.memory.size[available])<20M
```

Suffixes can also simplify the configuration of other entities - item keys, widgets, etc. To see if a configuration field supports suffixes, always see the relevant page for the entity being configured.

Time suffixes

Zabbix supports the following time suffixes:

- **s** - seconds (*when used, works the same as the raw value*)
- **m** - minutes
- **h** - hours
- **d** - days
- **w** - weeks
- **M** - months (*trend functions only*)
- **y** - years (*trend functions only*)

Note:

Time suffixes support only integer numbers. For example, "1h" is supported, but "1,5h" or "1.5h" is not; use "90m" instead.

Memory size suffixes

Zabbix supports the following memory size suffixes:

- **K** - kilobyte
- **M** - megabyte
- **G** - gigabyte
- **T** - terabyte

Other uses

Unit symbols are also used for a human-readable representation of data in Zabbix frontend.

Zabbix server and frontend support the following unit symbols (suffixes):

- **K** - kilo
- **M** - mega
- **G** - giga
- **T** - tera
- **P** - peta (*frontend only*)
- **E** - exa (*frontend only*)
- **Z** - zetta (*frontend only*)
- **Y** - yotta (*frontend only*)

Note:

When displaying item values in bytes (B) or bytes per second (Bps), a base 2 conversion is applied (1K = 1024B); otherwise, a base 10 conversion is applied (1K = 1000).

8 Time period syntax

Overview

To set a time period, the following format has to be used:

`d-d, hh:mm-hh:mm`

where the symbols stand for the following:

Symbol	Description
<i>d</i>	Day of the week: 1 - Monday, 2 - Tuesday ,... , 7 - Sunday
<i>hh</i>	Hours: 00-24
<i>mm</i>	Minutes: 00-59

You can specify more than one time period using a semicolon (;) separator:

`d-d, hh:mm-hh:mm; d-d, hh:mm-hh:mm . . .`

Leaving the time period empty equals 1-7,00:00-24:00, which is the default value.

Attention:

The upper limit of a time period is not included. Thus, if you specify 09:00-18:00 the last second included in the time period is 17:59:59.

Examples

Working hours. Monday - Friday from 9:00 till 18:00:

`1-5,09:00-18:00`

Working hours plus weekend. Monday - Friday from 9:00 till 18:00 and Saturday, Sunday from 10:00 till 16:00:

`1-5,09:00-18:00;6-7,10:00-16:00`

9 Command execution

Zabbix uses common functionality for external checks, user parameters, system.run items, custom alert scripts, remote commands and global scripts.

Execution steps

Note:

By default, all scripts in Zabbix are executed using the `sh` shell, and it is not possible to modify the default shell. To utilize a different shell, you can employ a workaround: create a script file and invoke that script during command execution.

The command/script is executed similarly on both Unix and Windows platforms:

1. Zabbix (the parent process) creates a pipe for communication
2. Zabbix sets the pipe as the output for the to-be-created child process
3. Zabbix creates the child process (runs the command/script)
4. A new process group (in Unix) or a job (in Windows) is created for the child process
5. Zabbix reads from the pipe until timeout occurs or no one is writing to the other end (ALL handles/file descriptors have been closed). Note that the child process can create more processes and exit before they exit or close the handle/file descriptor.
6. If the timeout has not been reached, Zabbix waits until the initial child process exits or timeout occurs
7. If the initial child process exited and the timeout has not been reached, Zabbix checks exit code of the initial child process and compares it to 0 (non-zero value is considered as execution failure, only for custom alert scripts, remote commands and user scripts executed on Zabbix server and Zabbix proxy)
8. At this point it is assumed that everything is done and the whole process tree (i.e. the process group or the job) is terminated

Attention:

Zabbix assumes that a command/script has done processing when the initial child process has exited AND no other process is still keeping the output handle/file descriptor open. When processing is done, ALL created processes are terminated.

All double quotes and backslashes in the command are escaped with backslashes and the command is enclosed in double quotes.

Exit code checking

Exit code are checked with the following conditions:

- Only for custom alert scripts, remote commands and user scripts executed on Zabbix server and Zabbix proxy.
- Any exit code that is different from 0 is considered as execution failure.
- Contents of standard error and standard output for failed executions are collected and available in frontend (where execution result is displayed).
- Additional log entry is created for remote commands on Zabbix server to save script execution output and can be enabled using LogRemoteCommands agent [parameter](#).

Possible frontend messages and log entries for failed commands/scripts:

- Contents of standard error and standard output for failed executions (if any).
- "Process exited with code: N." (for empty output, and exit code not equal to 0).
- "Process killed by signal: N." (for process terminated by a signal, on Linux only).
- "Process terminated unexpectedly." (for process terminated for unknown reasons).

See also

- [External checks](#)
- [User parameters](#)
- [system.run](#) items
- [Custom alert scripts](#)
- [Remote commands](#)
- [Global scripts](#)

10 Version compatibility

Supported agents

To be compatible with Zabbix 7.4, Zabbix agent must not be older than version 1.4 and must not be newer than 7.4.

You may need to review the configuration of older agents as some parameters have changed, for example, parameters related to [logging](#) for versions before 3.0.

To take full advantage of the latest functionality, metrics, improved performance and reduced memory usage, use the latest supported agent.

Notes for Windows XP

- On 32-bit Windows XP, do not use Zabbix agents newer than 6.0.x;
- On Windows XP/Server 2003, do not use agent templates that are newer than Zabbix 4.0.x. The newer templates use English performance counters, which are only supported since Windows Vista/Server 2008.

Supported agents 2

Older Zabbix agents 2 from version 4.4 onwards are compatible with Zabbix 7.4; Zabbix agent 2 must not be newer than 7.4.

Note that when using Zabbix agent 2 versions 4.4 and 5.0, the default interval of 10 minutes is used for refreshing unsupported items.

To take full advantage of the latest functionality, metrics, improved performance and reduced memory usage, use the latest supported agent 2.

Supported Zabbix proxies

To be fully compatible with Zabbix 7.4, the proxies must be of the same major version; thus only Zabbix 7.4.x proxies are fully compatible with Zabbix 7.4.x server. However, outdated proxies are also supported, although only partially.

In relation to Zabbix server, proxies can be:

- *Current* (proxy and server have the same major version);
- *Outdated* (proxy version is older than server version, but is partially supported);

- *Unsupported* (proxy version is older than server previous LTS release version *or* proxy version is newer than server major version).

Examples:

Server version	Current proxy version	Outdated proxy version	Unsupported proxy version
6.4	6.4	6.0, 6.2	Older than 6.0; newer than 6.4
7.0	7.0	6.0, 6.2, 6.4	Older than 6.0; newer than 7.0
7.2	7.2	7.0	Older than 7.0; newer than 7.2
7.4	7.4	7.0	Older than 7.0; newer than 7.4

Functionality supported by proxies:

Proxy version	Data update	Configuration update	Tasks
<i>Current</i>	Yes	Yes	Yes
<i>Outdated</i>	Yes	No	Remote commands (e.g., shell scripts); Immediate item value checks (i.e., <i>Execute now</i>); Note: Preprocessing tests with a real value are not supported.
<i>Unsupported</i>	No	No	No

Warnings about using incompatible Zabbix daemon versions are logged.

Supported XML files

XML files not older than version 1.8 are supported for import in Zabbix 7.4.

Attention:

In the XML export format, trigger dependencies are stored by name only. If there are several triggers with the same name (for example, having different severities and expressions) that have a dependency defined between them, it is not possible to import them. Such dependencies must be manually removed from the XML file and re-added after import.

11 Database error handling

If Zabbix detects that the backend database is not accessible, it will send a notification message and continue the attempts to connect to the database. For some database engines, specific error codes are recognized.

MySQL

- CR_CONN_HOST_ERROR
- CR_SERVER_GONE_ERROR
- CR_CONNECTION_ERROR
- CR_SERVER_LOST
- CR_UNKNOWN_HOST
- ER_SERVER_SHUTDOWN
- ER_ACCESS_DENIED_ERROR
- ER_ILLEGAL_GRANT_FOR_TABLE
- ER_TABLEACCESS_DENIED_ERROR
- ER_UNKNOWN_ERROR

12 Zabbix sender dynamic link library for Windows

Overview

In a Windows environment applications can send data to Zabbix server/proxy by using the Zabbix sender dynamic link library (zabbix_sender.dll) instead of having to launch an external process (zabbix_sender.exe).

zabbix_sender.h and zabbix_sender.lib are required for compiling user applications with zabbix_sender.dll.

Getting it

There are two ways of getting zabbix_sender.dll.

1. [Download](#) zabbix_sender.h, zabbix_sender.lib and zabbix_sender.dll files as a ZIP archive.

When choosing download options make sure to select "No encryption" under *Encryption* and "Archive" under *Packaging*. Then download Zabbix agent (not Zabbix agent 2).

The zabbix_sender.h, zabbix_sender.lib and zabbix_sender.dll files will be inside the downloaded ZIP archive in the bin\dev directory. Unzip the files where you need it.

2. Build zabbix_sender.dll from source (see [instructions](#)).

The dynamic link library with the development files will be located in the bin\winXX\dev directory. To use it, include the zabbix_sender.h header file and link with the zabbix_sender.lib library.

See also

- [example](#) of a simple Zabbix sender utility implemented with Zabbix sender dynamic link library to illustrate the library usage;
- [zabbix_sender.h](#) file for the interface functions of the Zabbix sender dynamic link library. This file contains documentation explaining the purpose of each interface function, its arguments, and return value.

13 Python library for Zabbix API

Overview

[zabbix_utils](#) is a Python library for:

- working with Zabbix API;
- acting like Zabbix sender;
- acting like Zabbix get.

It is supported for Zabbix 5.0, 6.0, 6.4 and later.

14 Service monitoring upgrade

Overview In Zabbix 6.0, [service monitoring](#) functionality has been reworked significantly (see [What's new in Zabbix 6.0.0](#) for the list of changes).

This page describes how services and SLAs, defined in earlier Zabbix versions, are changed during an upgrade to Zabbix 6.0 or newer.

Services In older Zabbix versions, services had two types of dependencies: soft and hard. After an upgrade, all dependencies will become equal.

If a service "Child service" has been previously linked to "Parent service 1" via hard dependency and additionally "Parent service 2" via soft dependency, after an upgrade the "Child service" will have two parent services "Parent service 1" and "Parent service 2".

Trigger-based mapping between problems and services has been replaced by tag-based mapping. In Zabbix 6.0 and newer, service configuration form has a new parameter *Problem tags*, which allows specifying one or multiple tag name and value pairs for problem matching. Triggers that have been linked to a service will get a new tag `ServiceLink: <trigger ID>:<trigger name>` (tag value will be truncated to 32 characters). Linked services will get `ServiceLink problem tag` with the same value.

Status calculation rules

The 'Status calculation algorithm' will be upgraded using the following rules:

- Do not calculate → Set status to OK
- Problem, if at least one child has a problem → Most critical of child services
- Problem, if all children have problems → Most critical if all children have problems

SLAs Previously, SLA targets had to be defined for each service separately. Since Zabbix 6.0, SLA has become a separate entity, which contains information about service schedule, expected service level objective (SLO) and downtime periods to exclude from the calculation. Once configured, an SLA can be assigned to multiple services through [service tags](#).

During an upgrade:

- Identical SLAs defined for each service will be grouped and one SLA per each group will be created.
- Each affected service will get a special tag SLA:<ID> and the same tag will be specified in the *Service tags* parameter of the corresponding SLA.
- Service creation time, a new metric in SLA reports, will be set to 01/01/2000 00:00 for existing services.

15 Other issues

Login and systemd

We recommend [creating](#) a *zabbix* user as system user, that is, without ability to log in. Some users ignore this recommendation and use the same account to log in (e. g. using SSH) to host running Zabbix. This might crash Zabbix daemon on log out. In this case you will get something like the following in Zabbix server log:

```
zabbix_server [27730]: [file:'selfmon.c',line:375] lock failed: [22] Invalid argument
zabbix_server [27716]: [file:'dbconfig.c',line:5266] lock failed: [22] Invalid argument
zabbix_server [27706]: [file:'log.c',line:238] lock failed: [22] Invalid argument
```

and in Zabbix agent log:

```
zabbix_agend [27796]: [file:'log.c',line:238] lock failed: [22] Invalid argument
```

This happens because of default systemd setting `RemoveIPC=yes` configured in `/etc/systemd/logind.conf`. When you log out of the system the semaphores created by Zabbix previously are removed which causes the crash.

A quote from systemd documentation:

`RemoveIPC=`

Controls whether System V and POSIX IPC objects belonging to the user shall be removed when the user fully logs out. Takes a boolean argument. If enabled, the user may not consume IPC resources after the last of the user's sessions terminated. This covers System V semaphores, shared memory and message queues, as well as POSIX shared memory and message queues. Note that IPC objects of the root user and other system users are excluded from the effect of this setting. Defaults to "yes".

There are 2 solutions to this problem:

1. (recommended) Stop using *zabbix* account for anything else than Zabbix processes, create a dedicated account for other things.
2. (not recommended) Set `RemoveIPC=no` in `/etc/systemd/logind.conf` and reboot the system. Note that `RemoveIPC` is a system-wide parameter, changing it will affect the whole system.

Using Zabbix frontend behind proxy

If Zabbix frontend runs behind proxy server, the cookie path in the proxy configuration file needs to be rewritten in order to match the reverse-proxied path. See examples below. If the cookie path is not rewritten, users may experience authorization issues, when trying to login to Zabbix frontend.

Example configuration for nginx

```
# ..
location / {
# ..
proxy_cookie_path /zabbix /;
proxy_pass http://192.168.0.94/zabbix/;
# ..
```

Example configuration for Apache

```
# ..
ProxyPass "/" http://host/zabbix/
ProxyPassReverse "/" http://host/zabbix/
ProxyPassReverseCookiePath /zabbix /
ProxyPassReverseCookieDomain host zabbix.example.com
```

. .

16 Agent vs agent 2 comparison

This section describes the differences between the Zabbix agent and the Zabbix agent 2.

Parameter	Zabbix agent	Zabbix agent 2
Programming language	C	Go with some parts in C
Daemonization	yes	by systemd only (yes on Windows)
Supported extensions	Custom loadable modules in C.	Custom plugins in Go.
<i>Requirements</i>		
Supported platforms	Linux, IBM AIX, FreeBSD, NetBSD, OpenBSD, HP-UX, Mac OS X, Solaris: 9, 10, 11, Windows: all desktop and server versions since XP	Linux, Windows: all desktop and server versions, on which an up-to-date supported Go version can be installed.
Supported crypto libraries	GnuTLS 3.1.18 and newer OpenSSL 1.0.1, 1.0.2, 1.1.0, 1.1.1, 3.0.x LibreSSL - tested with versions 2.7.4, 2.8.2 (certain limitations apply, see the Encryption page for details).	Linux: OpenSSL 1.0.1 and later. MS Windows: OpenSSL 1.1.1 or later. The OpenSSL library must have PSK support enabled. LibreSSL is not supported.
<i>Monitoring processes</i>		
Processes	A separate active check process for each server/proxy record.	Single process with automatically created threads. The maximum number of threads is determined by the GOMAXPROCS environment variable.
Metrics	UNIX: see a list of supported items . Windows: see a list of additional Windows-specific items .	UNIX: All metrics supported by Zabbix agent. Additionally, the agent 2 provides Zabbix-native monitoring solution for: Docker, Memcached, MySQL, PostgreSQL, Redis, systemd, and other monitoring targets - see a full list of agent 2 specific items . Windows: All metrics supported by Zabbix agent, and also net.tcp.service* checks of HTTPS, LDAP. Additionally, the agent 2 provides Zabbix-native monitoring solution for: PostgreSQL, Redis. Checks from different plugins or multiple checks within one plugin can be executed concurrently.
Concurrency	Active checks for single server are executed sequentially.	yes
Third-party traps	no	yes
<i>Additional features</i>		
Persistent storage	no	yes
Persistent files for log*[] metrics	yes (only on Unix)	no
Log data upload	Can be performed during log gathering to free the buffer.	Log gathering is stopped when the buffer is full, therefore the BufferSize parameter must be at least MaxLinesPerSecond x 2.
Changes user at runtime	yes (Unix-like systems only)	no (controlled by systemd)
User-configurable ciphersuites	yes	no

See also:

- *Zabbix processes description:* [Zabbix agent](#), [Zabbix agent 2](#)
- *Configuration parameters:* [Zabbix agent UNIX / Windows](#), [Zabbix agent 2 UNIX / Windows](#)

17 Escaping examples

Overview

This page provides examples of using correct escaping when using regular expressions in various contexts.

Note:

When using the trigger expression constructor, correct escaping in regular expressions is added automatically.

Examples

User macro with context

Regular expression: `\.+\"[a-z]+
` User macro with context: `{${MACRO}:regex:\".+\"[a-z]+}`

Notice:

- backslashes are **not escaped**;
- quotation marks are escaped.

LLD macro function

Regular expression: `\.+\"[a-z]+
` LLD macro: `{{#MACRO}}.iregsub(\".+\"[a-z]+\", \1)}`

Notice:

- backslashes are not escaped;
- quotation marks are escaped.

LLD macro function inside user macro context

Regular expression: `\.+\"[a-z]+
` LLD macro: `{{#MACRO}}.iregsub(\".+\"[a-z]+\", \1)
` User macro with context: `{${MACRO}:"{{#MACRO}}.iregsub(\".+\"[a-z]+\", \1)}"`

Notice:

- backslash escaping for LLD does not change;
- upon inserting the LLD macro into user macro context, we need to put it into string:
 1. Quotation marks are added around the macro expression;
 2. Quotation marks get escaped; in total, 3 new backslashes are introduced.

String parameter of function (any)

`concat` is used as example.

String content: `\.+\"[a-z]+
` Expression: `concat("abc", "\"\."+\"[a-z]+")`

Notice:

- String parameters require escaping both for backslashes and quotation marks.

LLD macro function inside string parameter of function

Regular expression: `\.+\"[a-z]+
` LLD macro: `{{#MACRO}}.iregsub(\".+\"[a-z]+\", \1)
` Expression: `concat("abc", "{{#MACRO}}.iregsub(\"\."+\"[a-z]+\", \1)}")`

Notice:

- String parameters require escaping both for backslashes and quotation marks;
- Another layer of escaping is added, because the macro will be resolved only after string is unquoted;

User macro with context inside string parameter of function

Regular expression: `\.+\"[a-z]+
` User macro with context: `{${MACRO}:regex:\".+\"[a-z]+}
` Expression: `concat("abc", "${MACRO}:regex:\"\."+\"[a-z]+\"")`

Notice:

- Same as in the previous example an additional layer of escaping is needed;
- Backslashes and quotation marks are escaped only for the top-level escaping (by virtue of it being a string parameter).

LLD macro function inside user macro context inside function

Regular expression: `\.+\"[a-z]+`
 LLD macro: `{{#MACRO}}.iregsub(\".+\\\"[a-z]+\", \\1)`
 User macro with context: ``${MACRO}:\"{{#MACRO}}.iregsub(\".+\\\"[a-z]+\", \\1)\"`
 Expression: `concat(\"abc\", \"`${MACRO}:\\\"{{#MACRO}}.iregsub(\\1)\\\"\"`)

Notice the three layers of escaping:

1. For LLD macro function, without escaping of backslashes;
2. For User macro with context, without escaping of backslashes;
3. For the string parameter of a function, with escaping of backslashes.

User macro with context just inside string

Regular expression: `\.+\"[a-z]+`
 User macro with context: ``${MACRO}:regex:\".+\\\"[a-z]+\"`
 Inside string of some expression, for example: `func(arg1, arg2, arg3)=\"`${MACRO}:regex:\\\"\\.+\\\"[a-z]+\"`

Notice:

- Strings also require backslash escaping;
 - Strings also require quotation mark escaping;
 - Again a case with 2 levels of escaping:
1. Escaping for user macro context without backslash escaping;
 2. Escaping for it being a string with backslash escaping.

23 Quick reference guides

Overview

This documentation section contains quick recipes for setting up Zabbix for some commonly required monitoring goals.

It is designed with the new Zabbix user in mind and can be used as a navigator through other documentation sections that contain information required for resolving the task.

The following quick reference guides are available:

- [Monitor Linux with Zabbix agent](#)
- [Monitor Windows with Zabbix agent](#)
- [Monitor Apache via HTTP](#)
- [Monitor MySQL with Zabbix agent 2](#)
- [Monitor VMware with Zabbix](#)
- [Monitor network traffic with Zabbix](#)
- [Monitor network traffic with Zabbix using active checks](#)
- [Monitor websites with Browser items](#)

1 Monitor Linux with Zabbix agent

Introduction This page walks you through the steps required to start basic monitoring of Linux machines with Zabbix. The steps described in this tutorial can be applied to any Linux-based operating system.

Who this guide is for

This guide is designed for new Zabbix users and contains the minimum set of steps required to enable basic monitoring of your Linux machine. If you are looking for deep customization options or require more advanced configuration, see [Configuration](#) section of Zabbix manual.

Prerequisites

Before proceeding with this installation guide, you must [download and install](#) Zabbix server and Zabbix frontend according to instructions for your OS.

Install Zabbix agent Zabbix agent is the process responsible for gathering data.

Check your Zabbix server version:

```
zabbix_server -V
```

Install Zabbix agent of the same version (recommended) on the Linux machine that you want to monitor. Based on your monitoring needs, it may be the same machine, where Zabbix server is installed, or a completely different machine.

Choose the most suitable installation method:

- Run as a Docker container - see the list of available images in [Zabbix Docker repository](#).
- Install from Zabbix [packages](#) (available for Alma Linux, CentOS, Debian, Oracle Linux, Raspberry Pi OS, RHEL, Rocky Linux, SUSE Linux Enterprise Server, Ubuntu).
- Compile [from sources](#).

Configure Zabbix for monitoring Zabbix agent can collect metrics in active or passive mode (simultaneously).

Note:

A passive check is a simple data request. Zabbix server or proxy asks for some data (for example, CPU load) and Zabbix agent sends back the result to the server. Active checks require more complex processing. The agent must first retrieve from the server(s) a list of items for independent processing and then bulk send the data back. See [Passive and active agent checks](#) for more info.

Monitoring templates provided by Zabbix usually offer two alternatives - a template for Zabbix agent and a template for Zabbix agent (active). With the first option, the agent will collect metrics in passive mode. Such templates will deliver identical monitoring results, but using different communication protocols.

Further Zabbix configuration depends on whether you select a template for [active](#) or [passive](#) Zabbix agent checks.

Passive checks Zabbix frontend

1. Log into Zabbix frontend.
2. [Create a host](#) in Zabbix web interface.

This host will represent your Linux machine.

3. In the *Interfaces* parameter, add *Agent* interface and specify the IP address or DNS name of the Linux machine where the agent is installed.
4. In the *Templates* parameter, type or select *Linux by Zabbix agent*.

New host

Host IPMI Tags Macros Inventory Encryption Value mapping

* Host name

Visible name

Templates
type here to search

* Host groups
type here to search

Interfaces	Type	IP address	DNS name	Connect to	Port
Agent		<input type="text" value="198.51.100.0"/>	<input type="text"/>	<input type="button" value="IP"/> <input type="button" value="DNS"/>	<input type="text" value="10050"/>

[Add](#)

Description

Zabbix agent

Open Zabbix agent configuration file (by default, the path is */usr/local/etc/zabbix_agentd.conf*):

```
sudo vi /usr/local/etc/zabbix_agentd.conf
```

Add the IP address or DNS name of your Zabbix server to the *Server* parameter.

For example:

Server=192.0.2.22

Active checks Zabbix frontend

1. Log in to Zabbix frontend.
2. **Create a host** in Zabbix web interface.

This host will represent your Linux machine.

3. In the *Templates* parameter, type or select *Linux by Zabbix agent active*.

New host

Host | IPMI | Tags | Macros | Inventory | Encryption | Value mapping

* Host name: Linux server

Visible name: Linux server

Templates: Linux by Zabbix agent x [Select]
type here to search

* Host groups: Linux servers x [Select]
type here to search

Interfaces: No interfaces are defined.
[Add](#)

Description: [Empty text area]

Zabbix agent

Open Zabbix agent configuration file (by default, the path is */usr/local/etc/zabbix_agentd.conf*):

```
sudo vi /usr/local/etc/zabbix_agentd.conf
```

Add:

- The name of the host you created in Zabbix web interface to the *Hostname* parameter.
- The IP address or DNS name of your Zabbix server to the *ServerActive* parameter.

For example:

ServerActive= 192.0.2.22

Hostname=Linux server

View collected metrics Congratulations! At this point, Zabbix is already monitoring your Linux machine.

To view collected metrics, open the *Monitoring->Hosts* menu section and click on the *Latest data* next to the host.

Name ▲	Interface	Availability	Tags	Status	Latest data	Problems
Linux server	127.0.0.1:10050	ZBX	class: os target: linux	Enabled	Latest data 64	1

This action will open a list of all the latest metrics collected from Linux server host.

<input type="checkbox"/> Host	Name ▲	Last check	Last value	Change	Tags
<input type="checkbox"/> Linux server	/: Free inodes in %	54s	71.1694 %		component: storage filesystem: /
<input type="checkbox"/> Linux server	/: Space utilization ?	53s	95.6273 %	+0.000327 %	component: storage filesystem: /
<input type="checkbox"/> Linux server	/: Total space ?	52s	13.55 GB		component: storage filesystem: /
<input type="checkbox"/> Linux server	/: Used space ?	51s	12.28 GB	+44 KB	component: storage filesystem: /
<input type="checkbox"/> Linux server	Available memory ?	43s	2.36 GB	+24 KB	component: memory
<input type="checkbox"/> Linux server	Available memory in % ?	42s	61.5978 %	+0.000398 %	component: memory

Set up problem alerts Zabbix can notify you about a problem with your infrastructure using a variety of methods. This guide provides configuration steps for sending email alerts.

1. Go to the *User settings -> Profile*, switch to the tab *Media* and **add your email**.

Media

Type

* Send to [Remove](#)

[Add](#)

* When active

Use if severity

- Not classified
- Information
- Warning
- Average
- High
- Disaster

Enabled

2. Follow the guide for **Receiving problem notification**.

Next time, when Zabbix detects a problem you should receive an alert via email.

Test your configuration On Linux, you can simulate high CPU load and as a result receive a problem alert by running:

```
cat /dev/urandom | md5sum
```

You may need to run several **md5sum** processes for CPU load to exceed the threshold.

When Zabbix detects the problem, it will appear in the Monitoring->Problems section.

Time ▼	<input type="checkbox"/> Severity	Recovery time	Status	Info	Host	Problem	Duration	Ack	Actions	Tags
2022-10-18 18:08:17	<input type="checkbox"/> Average		PROBLEM		Linux server	↑ /: Disk space is critically low (used > 90%) ?	15h 15m 26s	No		class: os compone filesystem: / ...

If the alerts are **configured**, you will also receive the problem notification.

See also:

- **Creating an item** - how to start monitoring additional metrics (custom monitoring without templates).
- **Zabbix agent items, Zabbix agent items for Windows** - full list of metrics you can monitor using Zabbix agent on Windows.
- **Problem escalations** - how to create multi-step alert scenarios (e.g., first send message to the system administrator, then, if a problem is not resolved in 45 minutes, send message to the data center manager).

2 Monitor Windows with Zabbix agent

Introduction This page walks you through the steps required to start basic monitoring of Windows machines with Zabbix.

Who this guide is for

This guide is designed for new Zabbix users and contains the minimum set of steps required to enable basic monitoring of your Windows machine. If you are looking for deep customization options or require more advanced configuration, see [Configuration](#) section of Zabbix manual.

Prerequisites

Before proceeding with this installation guide, you must [download and install](#) Zabbix server and Zabbix frontend according to instructions for your OS.

Install Zabbix agent Zabbix agent is the process responsible for gathering data. You need to install it on the Windows machine that you want to monitor. Follow Zabbix agent installation instructions for [Windows](#).

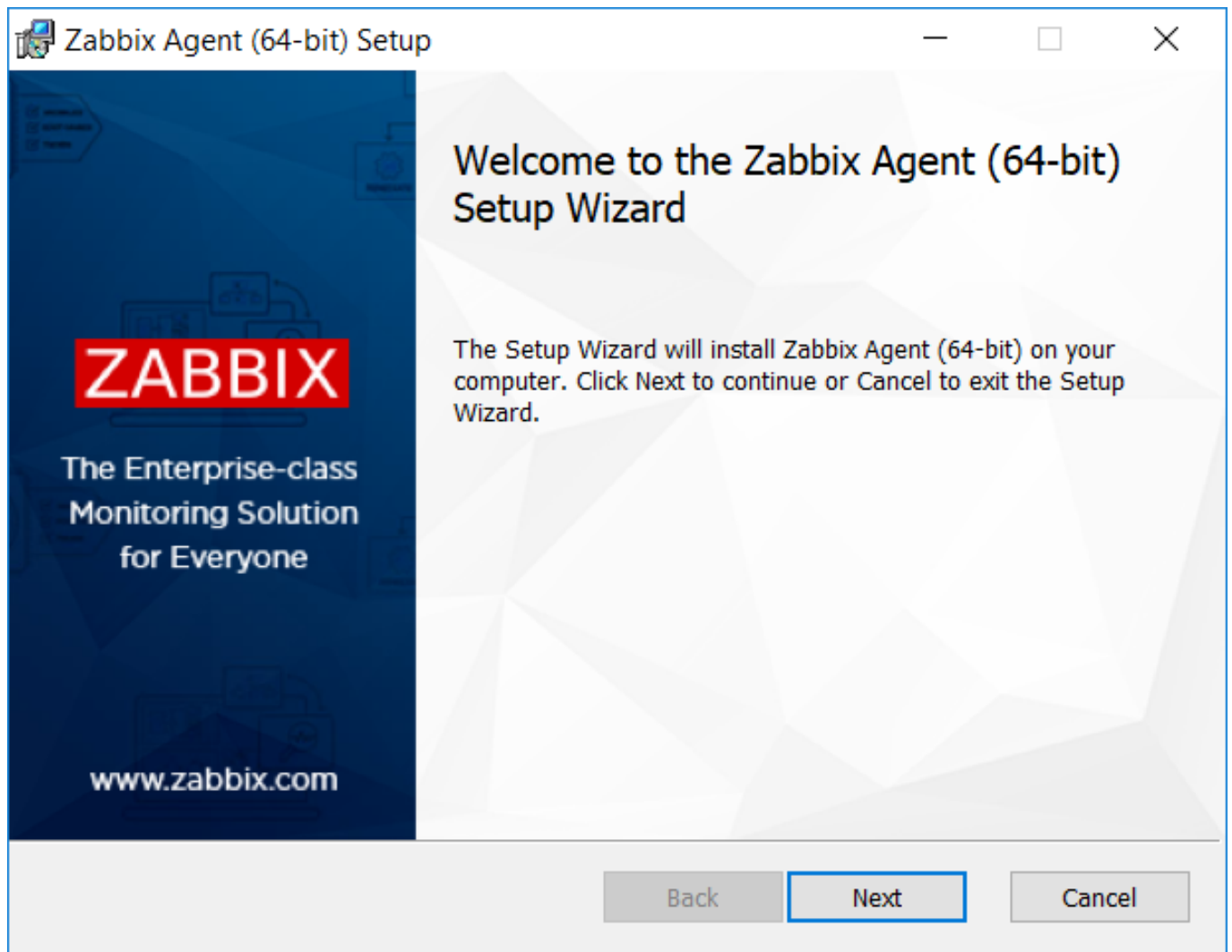

Configure Zabbix for monitoring Zabbix agent can collect metrics in active or passive mode (simultaneously).

Note:

A passive check is a simple data request. Zabbix server or proxy asks for some data (for example, CPU load) and Zabbix agent sends back the result to the server. Active checks require more complex processing. The agent must first retrieve from the server(s) a list of items for independent processing and then bulk send the data back. See [Passive and active agent checks](#) for more info.

Monitoring templates provided by Zabbix usually offer two alternatives - a template for Zabbix agent and a template for Zabbix agent (active). With the first option, the agent will collect metrics in passive mode. Such templates will deliver identical monitoring

results, but using different communication protocols.

Further Zabbix configuration depends on whether you select a template for **active** or **passive** Zabbix agent checks.

Passive checks Zabbix frontend

1. Log into Zabbix frontend.
2. **Create a host** in Zabbix web interface.

This host will represent your Windows machine.

3. In the *Interfaces* parameter, add *Agent* interface and specify the IP address or DNS name of the Windows machine where the agent is installed.
4. In the *Templates* parameter, type or select *Windows by Zabbix agent*.

The screenshot shows the 'New host' configuration page in Zabbix. The 'Host' tab is active. The form contains the following fields and options:

- Host name:** Windows workstation
- Visible name:** Windows workstation
- Templates:** A table with columns 'Name' and 'Action'. The entry 'Windows by Zabbix agent' is selected, with an 'Unlink' action.
- Host groups:** Windows servers (selected)
- Interfaces:** A table with columns 'Type', 'IP address', 'DNS name', 'Connect to', and 'Port'. The entry 'Agent' is added with IP address '198.51.100.0', 'IP' selected for 'Connect to', and '10050' for 'Port'.
- Description:** An empty text area.

Zabbix agent

For passive checks Zabbix agent needs to know the IP address or DNS name of Zabbix server. If you have provided correct information during the agent installation, the configuration file is already updated. Otherwise, you need to manually specify it. Go to the `C:\Program files\Zabbix Agent` folder, open the file `zabbix_agentd.conf` and add the IP/DNS of your Zabbix server to the `Server` parameter.

Example:

```
Server=192.0.2.22
```

Active checks Zabbix frontend

1. Log in to Zabbix frontend.
2. **Create a host** in Zabbix web interface.

This host will represent your Windows machine.

3. In the *Templates* parameter, type or select *Windows by Zabbix agent active*.

New host

Host **IPMI** Tags Macros Inventory Encryption Value mapping

* Host name

Visible name

Templates
type here to search

* Host groups
type here to search

Interfaces No interfaces are defined.
[Add](#)

Description

Zabbix agent

In the C:\Program files\Zabbix Agent folder open the file `zabbix_agentd.conf` and add:

- The name of the host you created in Zabbix web interface to the `Hostname` parameter.
- The IP address or DNS name of your Zabbix server machine to the `ServerActive` parameter (might be prefilled if you have provided it during Zabbix agent setup).

Example:

```
ServerActive= 192.0.2.22
Hostname=Windows workstation
```

View collected metrics Congratulations! At this point, Zabbix is already monitoring your Windows machine.

To view collected metrics, open the *Monitoring*->*Hosts* menu section and click on the *Latest data* next to the host.

Name ▲	Interface	Availability	Tags	Status	Latest data
Windows workstation	198.51.100.0:10050	ZBX		Enabled	Latest data 32

Set up problem alerts Zabbix can notify you about a problem with your infrastructure using a variety of methods. This guide provides configuration steps for sending email alerts.

1. Go to the *User settings* -> *Profile*, switch to the tab *Media* and **add your email**.

Media



Type

* Send to [Remove](#)

[Add](#)

* When active

Use if severity Not classified
 Information
 Warning
 Average
 High
 Disaster

Enabled

Add

Cancel

2. Follow the guide for [Receiving problem notification](#).

Next time, when Zabbix detects a problem you should receive an alert via email.

Note:

On Windows, you can use [CpuStres](#) utility to simulate high CPU load and as a result receive a problem alert.

See also:

- [Creating an item](#) - how to start monitoring additional metrics (custom monitoring without templates).
- [Zabbix agent items](#), [Zabbix agent items for Windows](#) - full list of metrics you can monitor using Zabbix agent on Windows.
- [Problem escalations](#) - how to create multi-step alert scenarios (e.g., first send message to the system administrator, then, if a problem is not resolved in 45 minutes, send message to the data center manager).

3 Monitor Apache via HTTP

Introduction This page shows a quick and simple way to start monitoring an Apache web server without installing any additional software.

Who this guide is for

This guide is designed for new Zabbix users and contains the minimum set of steps required to enable basic monitoring of your Apache installation. If you are looking for deep customization options or require more advanced configuration, see [Configuration](#) section of Zabbix manual.

Prerequisites

Before proceeding with this installation guide, you must [download and install](#) Zabbix server and Zabbix frontend according to instructions for your OS.

Prepare Apache 1. Check, which Apache version you are using:

On RHEL-based system, run:

```
httpd -v
```

On Debian/Ubuntu, run:

```
apache2 -v
```

2. Make sure that the [Status module](#) is enabled in your Apache instance.

On RHEL-based system, run:

```
httpd -M | grep status
status_module (shared)
```

On Debian/Ubuntu, run:

```
apache2ctl -M | grep status
status_module (shared)
```

If you don't see `status_module` in the list, enable the module by running:

On RHEL-based system, run:

```
LoadModule status_module /usr/lib/apache2/modules/mod_status.so
```

On Debian/Ubuntu, run:

```
sudo /usr/sbin/a2enmod status
```

3. Edit Apache configuration file to allow access to status reports from Zabbix server IP.

On an RHEL-based system: `/etc/httpd/conf.modules.d/status.conf`:

```
sudo vi /etc/httpd/conf.modules.d/status.conf
```

On Debian/Ubuntu: `/etc/apache2/mods-enabled/status.conf`:

```
sudo vi /etc/apache2/mods-enabled/status.conf
```

Add the following lines to the file (**replace 198.51.100.255** with your Zabbix server IP address):

- For Apache 2.2:
`<Location /server-status> SetHandler server-status`
`Order Deny,Allow Deny from all Allow from 198.51.100.255 </Location>`
- For Apache 2.4:
`<Location "/server-status"> SetHandler server-status Require ip 198.51.100.255 </Location>`

4. Restart Apache

On an RHEL-based system, run:

```
sudo systemctl restart httpd
```

On Debian/Ubuntu, run:

```
sudo systemctl restart apache2
```

5. To check, if everything is configured correctly, run (**replace 198.51.100.255** with your Zabbix server IP address):

```
curl 198.51.100.255/server-status
```

The response should contain Apache web server statistics.

Configure Zabbix for monitoring 1. Log into Zabbix frontend.

2. **Create a host** in Zabbix web interface.

This host will represent your Apache server.

3. In the *Interfaces* parameter, add *Agent* interface and specify your Apache instance IP address. **You don't need to install Zabbix agent on the machine**, the interface will only be used for resolving `{HOST.CONN}` macro. This macro is used in template items to locate Apache instance.

4. In the *Templates* parameter, type or select *Apache by HTTP*.

New host

Host IPMI Tags Macros Inventory Encryption Value mapping

* Host name

Visible name

Templates
type here to search

* Host groups
type here to search

Interfaces	Type	IP address	DNS name
Agent		<input type="text" value="198.51.100.255"/>	<input type="text"/>

[Add](#)

Description

Monitored by proxy

Enabled

5. Switch to the **Macros** tab and select *Inherited and host macros* mode. Check that values of the macros `{$APACHE.STATUS.PORT}` and `{$APACHE.STATUS.SCHEME}` suit your installation settings. By default, the port is 80 and the scheme is http. Change macro values if you use different port and/or scheme.

New host

Host IPMI Tags **Macros** Inventory Encryption Value mapping

Host macros **Inherited and host macros**

Macro	Effective value	Template value
{\$APACHE.RESPONSE_TIME.MAX.WARN}	10	Apache by HTTP: "10"
Maximum Apache response time in seconds for trigger expression		
{\$APACHE.STATUS.PATH}	server-status?auto	Apache by HTTP: "server-status?auto"
The URL path		
{\$APACHE.STATUS.PORT}	80	Apache by HTTP: "80"
The port of Apache status page		
{\$APACHE.STATUS.SCHEME}	http	Apache by HTTP: "http"
Request scheme which may be http or https		
{\$SNMP_COMMUNITY}	public	Change
description		

[Add](#)

View collected metrics Congratulations! At this point, Zabbix is already monitoring your Apache web server.

To view collected metrics, open the *Monitoring->Hosts* menu section and click on the *Dashboards* next to the host.

Name	Interface	Availability	Tags	Status	Latest data	Problems	Graphs	Dashboards
Apache server	10.0.3.69:10050	ZBX	class: software target: apache	Enabled	Latest data 28	1	Graphs 5	Dashboards 1

This action will take you to the host dashboard with most important metrics collected from Apache /server-status page.

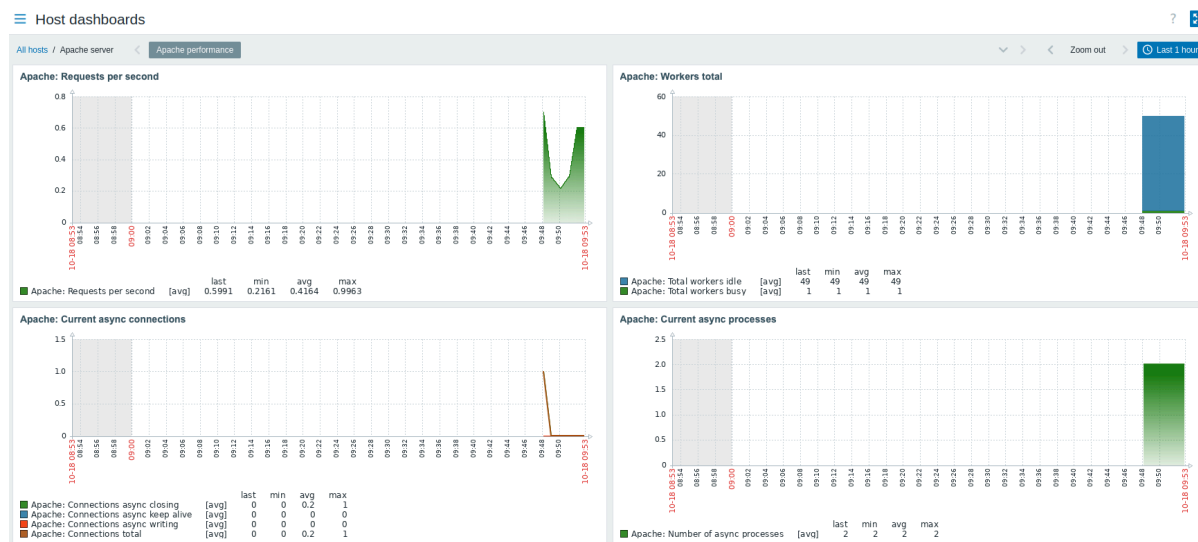

Alternatively, from the *Monitoring->Hosts*, you can click on the *Latest data* to view all the latest collected metrics in a list.

Host	Name	Last check	Last value	Change	Tags	Info
Apache server	Apache: Bytes per request	32s	5.93 KB	+921.92 B	component: connection	Graph
Apache server	Apache: Bytes per second	32s	2.56 KBps	+1.57 KBps	component: network	Graph
Apache server	Apache: Connections async closing	32s	0	-1	component: connection	Graph
Apache server	Apache: Connections async keep alive	32s	0		component: connection	Graph
Apache server	Apache: Connections async writing	32s	0		component: connection	Graph
Apache server	Apache: Connections total	32s	0	-1	component: connection	Graph
Apache server	Apache: Get status	32s	("Date": "Tue, 18 Oct 2022 ...		component: raw	History
Apache server	Apache: Number of async processes	32s	2		component: system	Graph
Apache server	Apache: Requests per second	32s	0.283	-0.7133	component: network	Graph

Set up problem alerts Zabbix can notify you about a problem with your infrastructure using a variety of methods. This guide provides configuration steps for sending email alerts.

1. Go to the *User settings -> Profile*, switch to the tab *Media* and **add your email**.

Media ✕

Type

* Send to [Remove](#)

[Add](#)

* When active

Use if severity Not classified
 Information
 Warning
 Average
 High
 Disaster

Enabled

2. Follow the guide for **Receiving problem notification**.

Next time, when Zabbix detects a problem you should receive an alert via email.

Test your configuration To simulate real problem and receive a test problem alert:

1. Open the *Apache server* host configuration in Zabbix.
2. Switch to the *Macros* tab and select *Inherited and host macros*.
3. Press *Change* next to `{$APACHE.STATUS.PORT}` macro and set a different port.
4. Press *Update* to save host configuration.
5. In a few minutes, Zabbix will detect the problem *Apache service is down*, because now it cannot connect to the instance. It will appear in the *Monitoring->Problems* section.

Time	Severity	Recovery time	Status	Info	Host	Problem	Duration	Ack	Actions
09:34:16	Average		PROBLEM		Apache server	↑ Apache: Service is down	45s	No	

If the alerts are **configured**, you will also receive the problem notification.

6. Change the macro value back to resolve the problem and continue monitoring Apache.

See also:

- **Web server hardening** - recommended settings for greater web server security.
- **Creating an item** - how to start monitoring additional metrics.
- **HTTP items** - how to monitor custom metrics using HTTP agent.
- **Problem escalations** - how to create multi-step alert scenarios (e.g., first send message to the system administrator, then, if a problem is not resolved in 45 minutes, send message to the data center manager).

4 Monitor MySQL with Zabbix agent 2

Introduction

This page walks you through the steps required to start basic monitoring of a MySQL server.

To monitor a MySQL server, there are several approaches: Zabbix agent, Zabbix agent 2, or the Open Database Connectivity (ODBC) standard. The primary focus of this guide is on monitoring a MySQL server with Zabbix agent 2, which is the **recommended** approach due to its seamless configuration across various setups. However, this page also offers instructions for the **other approaches**, so feel free to choose the one that best suits your requirements.

Who this guide is for

This guide is designed for new Zabbix users and contains the minimum set of steps required to enable basic monitoring of a MySQL server. If you are looking for deep customization options or require more advanced configuration, see the **Configuration** section of Zabbix manual.

Prerequisites

Before proceeding with this guide, you need to [download and install](#) Zabbix server, Zabbix frontend and Zabbix agent 2 according to the instructions for your OS.

Based on your setup, some of the steps in this guide may slightly differ. This guide is based on the following setup:

- Zabbix version: Zabbix 7.2 PRE-RELEASE (installed from packages)
- OS distribution: Ubuntu
- OS version: 22.04 (Jammy)
- Zabbix components: Server, Frontend, Agent 2
- Database: MySQL
- Web server: Apache

Create MySQL user

To monitor a MySQL server, Zabbix requires access to it and its processes. Your MySQL installation already has a user with the required level of access (the user "zabbix" that was created when installing Zabbix), however, this user has more privileges than necessary for simple monitoring (privileges to DROP databases, DELETE entries from tables, etc.). Therefore, a MySQL user for the purpose of *only* monitoring the MySQL server needs to be created.

1. Connect to the MySQL client, create a "zbx_monitor" user (replace *<password>* for the "zbx_monitor" user with a password of your choice), and **GRANT** the necessary privileges to the user:

```
mysql -u root -p
# Enter password:
```

```
mysql> CREATE USER 'zbx_monitor'@'%' IDENTIFIED BY '<password>';
mysql> GRANT REPLICATION CLIENT,PROCESS,SHOW DATABASES,SHOW VIEW ON *.* TO 'zbx_monitor'@'%';
mysql> quit;
```

Once the user is created, you can move on to the next step.

Configure Zabbix frontend

1. Log into Zabbix frontend.

2. **Create a host** in Zabbix web interface:

- In the *Host name* field, enter a host name (e.g., "MySQL server").
- In the *Templates* field, type or select the template "MySQL by Zabbix agent 2" that will be **linked** to the host.
- In the *Host groups* field, type or select a host group (e.g., "Databases").
- In the *Interfaces* field, add an interface of type "Agent" and specify your MySQL server IP address. This guide uses "127.0.0.1" (localhost) for monitoring a MySQL server that is installed on the same machine as Zabbix server and Zabbix agent 2.

New host ? X

Host IPMI Tags **Macros** Inventory Encryption Value mapping

* Host name

Visible name

Templates
type here to search

* Host groups
type here to search

Interfaces	Type	IP address	DNS name	Connect to	Port	Default
Agent		<input type="text" value="127.0.0.1"/>	<input type="text"/>	<input checked="" type="radio"/> IP <input type="radio"/> DNS	<input type="text" value="10050"/>	<input checked="" type="radio"/> Remove

[Add](#)

Description

Monitored by proxy

Enabled

- In the **Macros** tab, switch to *Inherited and host macros*, look for the following macros and click on *Change* next to the macro value to update it:
 - `{$MYSQL.DSN}` - set the data source of the MySQL server (the **connection string of a named session** from the MySQL Zabbix agent 2 plugin configuration file). This guide uses the default data source "tcp://localhost:3306" for monitoring a MySQL server that is installed on the same machine as Zabbix server and Zabbix agent 2.
 - `{$MYSQL.PASSWORD}` - set the password of the previously **created MySQL user** "zbx_monitor".
 - `{$MYSQL.USER}` - set the name of the previously **created MySQL user** "zbx_monitor".

New host ? X

Host IPMI Tags **Macros 3** Inventory Encryption Value mapping

The maximum number of created tmp files on a disk per second for trigger expressions.
`{$MYSQL.CREATED_TMP_TABLES.MAX.WARN}` [Change](#) ← MySQL by Zabbix agent 2: "30"

The maximum number of created tmp tables in memory per second for trigger expressions.
`{$MYSQL.DSN}` [Remove](#) ← MySQL by Zabbix agent 2: "<Put your DSN>"
System data source name such as <tcp://host:port or unix://path/to/socket/>.

`{$MYSQL.INNODB_LOG_FILES}` [Change](#) ← MySQL by Zabbix agent 2: "2"

Number of physical files in the InnoDB redo log for calculating innodb_log_file_size.
`{$MYSQL.PASSWORD}` [Remove](#) ← MySQL by Zabbix agent 2: ""
MySQL user password.

`{$MYSQL.REPL_LAG.MAX.WARN}` [Change](#) ← MySQL by Zabbix agent 2: "30m"
The lag of slave from master for trigger expression.

`{$MYSQL.SLOW_QUERIES.MAX.WARN}` [Change](#) ← MySQL by Zabbix agent 2: "3"
The number of slow queries for trigger expression.

`{$MYSQL.USER}` [Remove](#) ← MySQL by Zabbix agent 2: ""
MySQL user name.

`{$SNMP_COMMUNITY}` [Change](#) ← "public"
description

[Add](#)

3. Click on *Add* to add the host. This host will represent your MySQL server.

View collected metrics

Congratulations! At this point, Zabbix is already monitoring your MySQL server.

To view collected metrics, navigate to the *Monitoring* → *Hosts* menu section and click on *Dashboards* next to the host.

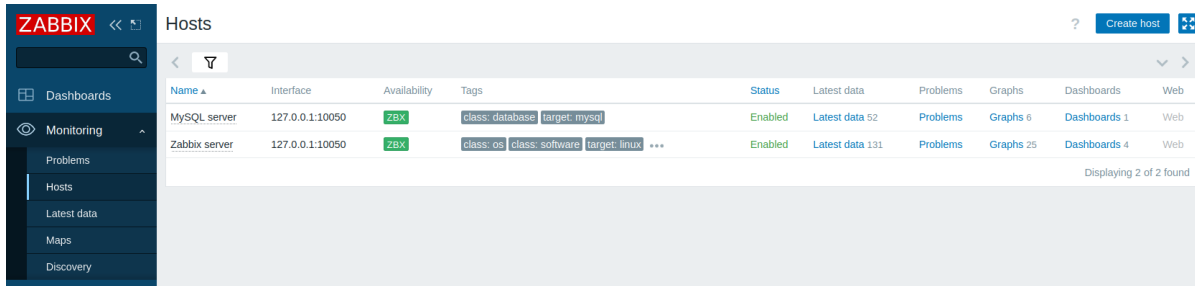

This action will take you to the host dashboard (configured on the template level) with the most important metrics collected from the MySQL server.



Alternatively, from the *Monitoring* → *Hosts* menu section, you can click on *Latest data* to view all the latest collected metrics in a list. Note that the item *MySQL: Calculated value of innodb_log_file_size* is expected to have no data, as the value will be calculated from data in the last hour.

Subfilter affects only filtered data

HOSTS
MySQL server 52

TAGS
component 52 database 4

TAG VALUES
component: application 3 cache 1 connections 10 health 1 innodb 11 memory 10 network 2 operations 4 queries 3 raw 1 storage 6 system 3 tables 7 threads 4
database: mysql 1 performance_schema 1 sys 1 zabbix 1

DATA
With data Without data

<input type="checkbox"/>	Host	Name ▲	Last check	Last value	Change	Tags	Info
<input type="checkbox"/>	MySQL server	MySQL: Aborted clients per second [?]	50s	0		component: connecti...	Graph
<input type="checkbox"/>	MySQL server	MySQL: Aborted connections per second [?]	50s	0.01664	-0.0002836	component: connecti...	Graph
<input type="checkbox"/>	MySQL server	MySQL: Binlog cache disk use [?]	10m 49s	4		component: cache	Graph
<input type="checkbox"/>	MySQL server	MySQL: Buffer pool efficiency [?]	52s	0.02212 %	-0.0005752 %	component: memory	Graph
<input type="checkbox"/>	MySQL server	MySQL: Buffer pool utilization [?]	51s	46.8506 %		component: memory	Graph
<input type="checkbox"/>	MySQL server	MySQL: Bytes received [?]	50s	4.3 KBps	+700.9298 ...	component: network	Graph
<input type="checkbox"/>	MySQL server	MySQL: Bytes sent [?]	50s	81.09 KBps	+5.02 KBps	component: network	Graph
<input type="checkbox"/>	MySQL server	MySQL: Calculated value of innodb_log_file_size [?]				component: system	Graph !
<input type="checkbox"/>	MySQL server	MySQL: Command Delete per second [?]	50s	0.0832	+0.06627	component: operations	Graph

Set up problem alerts

Zabbix can notify you about a problem with your infrastructure using a variety of methods. This guide provides basic configuration steps for sending email alerts.

1. Navigate to *User settings* → *Profile*, switch to the *Media* tab and **add your email**.

Media



Type

* Send to [Remove](#)

[Add](#)

* When active

Use if severity

- Not classified
- Information
- Warning
- Average
- High
- Disaster

Enabled

2. Follow the guide for **Receiving a problem notification**.

Next time, when Zabbix detects a problem, you should receive an alert via email.

Test your configuration

To test your configuration, we can simulate a real problem by updating the host configuration in Zabbix frontend.

1. Open your MySQL server host configuration in Zabbix.
2. Switch to the *Macros* tab and select *Inherited and host macros*.

- Click on *Change* next to, for example, the **previously configured** `{MYSQL.USER}` macro value and set a different MySQL user name.
- Click on *Update* to update the host configuration.
- In a few moments, Zabbix will detect the problem "MySQL: Service is down", because it will not be able to connect to the MySQL server. The problem will appear in *Monitoring → Problems*.

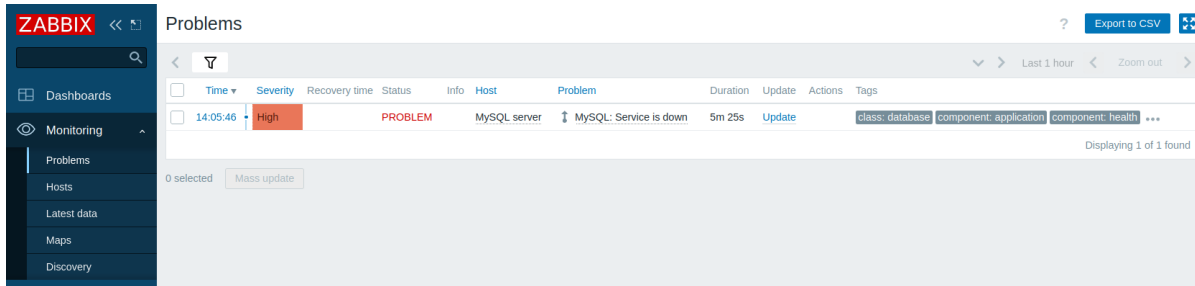

If alerts are **configured**, you will also receive the problem notification.

- Change the macro value back to its previous value to resolve the problem and continue monitoring the MySQL server.

Other approaches to monitor MySQL

Instead of monitoring a MySQL server with Zabbix agent 2, you could also use Zabbix agent or the Open Database Connectivity (ODBC) standard. While using Zabbix agent 2 is recommended, there might be some setups that do not support Zabbix agent 2 or require a custom approach.

The key difference between Zabbix agent and ODBC lies in the data collection method - Zabbix agent is installed directly on the MySQL server and collects data using its built-in functionality, while ODBC relies on an ODBC driver to establish a connection to the MySQL server and retrieve data using SQL queries.

Although many of the configuration steps are similar to monitoring a MySQL server with Zabbix agent 2, there are some significant differences - you need to configure Zabbix agent or ODBC to be able to monitor a MySQL server. The following instructions walk you through these **differences**.

Monitor MySQL with Zabbix agent

To monitor a MySQL server with Zabbix agent, you need to [download and install](#) Zabbix server, Zabbix frontend and Zabbix agent according to the instructions for your OS.

Once you have successfully installed the required Zabbix components, you need to create a MySQL user as described in the [Create MySQL user](#) section.

After you have created the MySQL user, you need to configure Zabbix agent to be able to establish a connection with the MySQL server and monitor it. This includes configuring multiple **user parameters** for executing custom agent checks, as well as providing Zabbix agent with the necessary credentials for connecting to the MySQL server as the **previously created** "zbx_monitor" user.

Configure Zabbix agent

- Navigate to the Zabbix agent additional configurations directory.

```
cd /usr/local/etc/zabbix/zabbix_agentd.d
```

Attention:

The Zabbix agent additional configurations directory should be located in the same directory as your Zabbix agent configuration file (*zabbix_agentd.conf*). Depending on your OS and Zabbix installation, this directory can have a different location than specified in this guide. For default locations, check the **Include** parameter in the Zabbix agent configuration file.

Instead of defining all of the necessary user parameters for monitoring the MySQL server in the Zabbix agent configuration file, these parameters will be defined in a separate file in the additional configurations directory.

- Create a *template_db_mysql.conf* file in the Zabbix agent additional configurations directory.

```
vi template_db_mysql.conf
```

- Copy the contents from the *template_db_mysql.conf* file (located in the Zabbix repository) to the *template_db_mysql.conf* file you created, and save.

- Restart Zabbix agent to update its configuration.

```
systemctl restart zabbix-agent
```

Once you have configured Zabbix agent user parameters, you can move on to configure the credentials that will allow Zabbix agent to access the MySQL server.

5. Navigate to the Zabbix agent home directory (if it does not exist on your system, you need to create it; default: `/var/lib/zabbix`).

```
cd /var/lib/zabbix
```

6. Create a `.my.cnf` file in the Zabbix agent home directory.

```
vi .my.cnf
```

7. Copy the following contents to the `.my.cnf` file (replace `<password>` with the password of the "zbx_monitor" user).

```
[client]
user='zbx_monitor'
password='<password>'
```

Configure Zabbix frontend and test your configuration

To configure Zabbix frontend, follow the instructions in the *Configure Zabbix frontend* section with the following adjustments:

- In the *Templates* field, type or select the template "MySQL by Zabbix agent" that will be *linked* to the host.
- Configuring *Macros* is not required.

Once you have configured Zabbix frontend, you can *view collected metrics* and *set up problem alerts*.

To test your configuration, follow the instructions in the *Test your configuration* section with the following adjustments:

- In the *Inherited and host macros* section of the MySQL server host configuration, click on *Change* next to the `{$MYSQL.PORT}` macro value and set a different port (e.g., "6033").

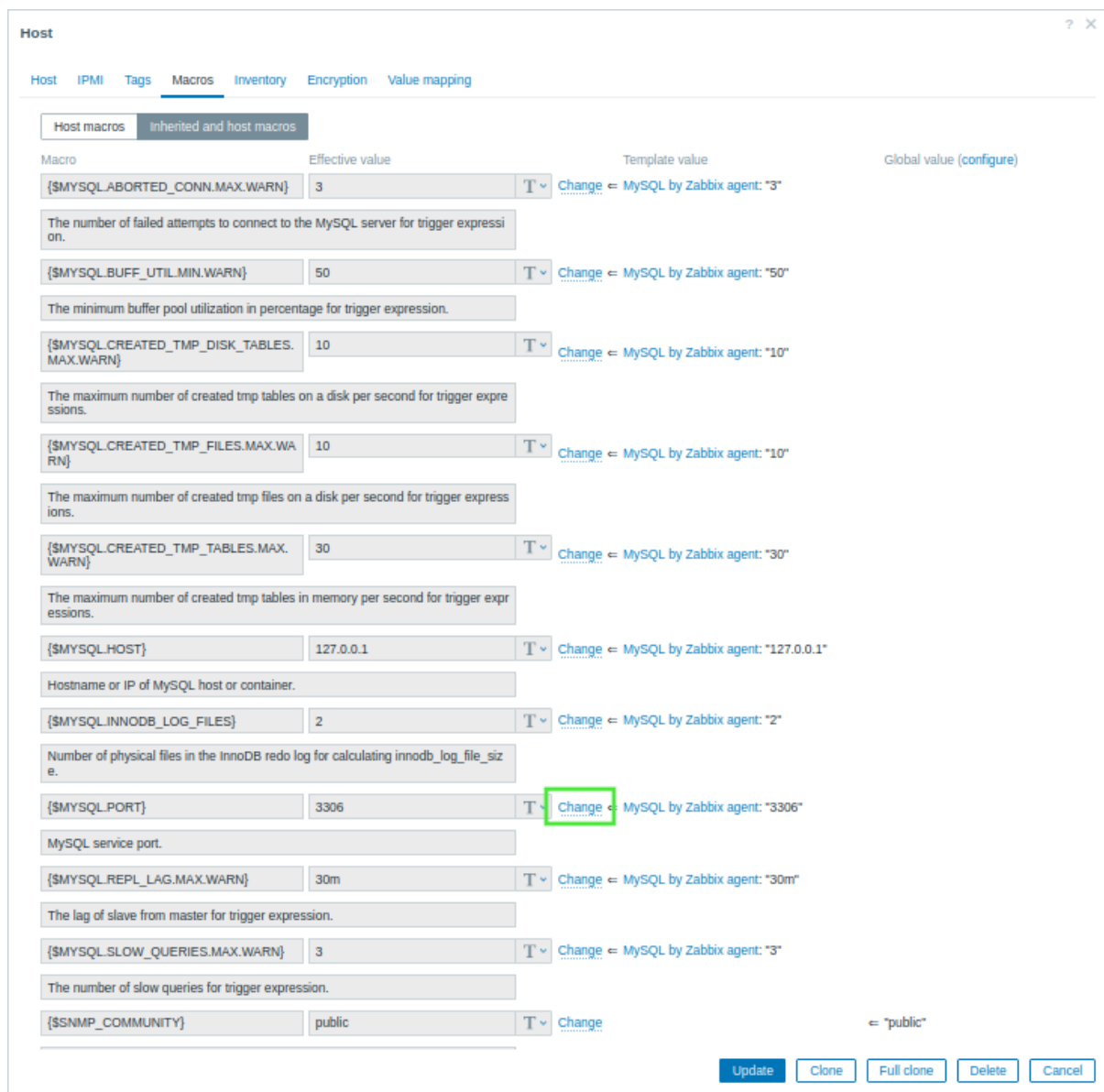

To monitor a MySQL server with ODBC, you need to [download and install](#) Zabbix server and Zabbix frontend.

Once you have successfully installed the required Zabbix components, you need to create a MySQL user as described in the [Create MySQL user](#) section.

After you have created the MySQL user, you need to setup ODBC. This includes installing one of the most commonly used open source ODBC API implementations - [unixODBC](#) - and a unixODBC driver, as well as editing the ODBC driver configuration file.

Configure ODBC

1. Install unixODBC. The suggested way of installing unixODBC is to use the Linux operating system default package repositories.

```
apt install unixodbc
```

2. Install the MariaDB unixODBC database driver. Although you have a MySQL database, the MariaDB unixODBC driver is used for compatibility issues.

```
apt install odbc-mariadb
```

3. Check the location of the ODBC configuration files *odbcinst.ini* and *odbc.ini*.

```
odbcinst -j
```

The result of executing this command should be similar to the following.

```
unixODBC 2.3.9
DRIVERS.....: /etc/odbcinst.ini
SYSTEM DATA SOURCES: /etc/odbc.ini
FILE DATA SOURCES..: /etc/ODBCDataSources
...
```

4. To configure the ODBC driver for monitoring a MySQL database, you need the driver name, which is located in the *odbcinst.ini* file. In the following *odbcinst.ini* file example, the driver name is "MariaDB Unicode".

```
[MariaDB Unicode]
Driver=libmaodbc.so
Description=MariaDB Connector/ODBC(Unicode)
Threading=0
UsageCount=1
```

5. Copy the following contents to the *odbc.ini* file (replace *<password>* with the password of the "zbx_monitor" user). This guide uses "127.0.0.1" (localhost) as the MySQL server address for monitoring a MySQL server that is installed on the same machine as the ODBC driver. Note the data source name (DSN) "test", which will be required when [configure Zabbix frontend](#).

```
[test]
Driver=MariaDB Unicode
Server=127.0.0.1
User=zbx_monitor
Password=<password>
Port=3306
Database=zabbix
```

Configure Zabbix frontend and test your configuration

To configure Zabbix frontend, follow the instructions in the [Configure Zabbix frontend](#) section with the following adjustments:

- In the *Templates* field, type or select the template "MySQL by ODBC" that will be [linked](#) to the host.
- Configuring *Interfaces* is not required.
- The `{ $MYSQL.DSN }` macro value in the *Inherited and host macros* section of the MySQL server host configuration should be set to the DSN name from the *odbc.ini* file.

Once you have configured Zabbix frontend, you can [view collected metrics](#), [set up problem alerts](#) and [test your configuration](#).

See also

- [Creating an item](#) - how to start monitoring additional metrics.
- [Problem escalations](#) - how to create multi-step alert scenarios (e.g., first send message to the system administrator, then, if a problem is not resolved in 45 minutes, send message to the data center manager).
- [ODBC monitoring](#) - how to set up ODBC on other Linux distributions, and how to start monitoring additional database-related metrics with ODBC.
- Template [MySQL by Zabbix agent](#) - additional information about the *MySQL by Zabbix agent* template.
- Template [MySQL by Zabbix agent 2](#) - additional information about the *MySQL by Zabbix agent 2* template.
- Template [MySQL by ODBC](#) - additional information about the *MySQL by ODBC* template.

5 Monitor VMware with Zabbix

Introduction

This page walks you through the steps required to start basic monitoring of VMware.

Who this guide is for

This guide is designed for new Zabbix users and contains the minimum set of steps required to enable basic monitoring of VMware. If you are looking for deep customization options or require more advanced configuration, see the [Virtual machine monitoring](#) section or the [Configuration](#) section of Zabbix manual.

Prerequisites

Before proceeding with this guide, you need to [download and install](#) Zabbix server and Zabbix frontend according to the instructions for your OS.

This guide is based on the following setup:

- Zabbix version: 7.2 PRE-RELEASE (installed from packages)
- OS distribution: Ubuntu
- OS version: 22.04 (Jammy)
- Zabbix components: Server, Frontend, Agent
- Database: MySQL
- Web server: Apache

It is assumed that VMware is already configured. This guide does not cover the configuration of VMware.

Configure Zabbix server

To monitor VMware, the *vmware collector* Zabbix processes need to be enabled. For more information on how VMware monitoring is performed, see [Virtual machine monitoring](#).

1. Open the Zabbix server configuration file.

```
vi /etc/zabbix/zabbix_server.conf
```

2. Locate and set the `StartVMwareCollectors` parameter in Zabbix server configuration file to 2 or more (the default value is 0).

```
##### Option: StartVMwareCollectors
###      Number of pre-forked vmware collector instances.
###
### Mandatory: no
### Range: 0-250
### Default:
### StartVMwareCollectors=0
```

```
StartVMwareCollectors=2
```

3. Restart Zabbix server.

```
systemctl restart zabbix-server
```

Once the *vmware collector* processes have been started, move on to the next step.

Configure Zabbix frontend

1. Log into Zabbix frontend.

2. **Create a host** in Zabbix web interface:

- In the *Host name* field, enter a host name (for example, "VMware environment").
- In the *Templates* field, type or select the "VMware FQDN" (or "VMware") template. For more information on these templates, see [Virtual machine monitoring](#).
- In the *Host groups* field, type or select a host group (for example, a new host group "VMware").

New host ? X

Host IPMI Tags Macros Inventory Encryption Value mapping

* Host name

Visible name

Templates
type here to search

* Host groups
type here to search

Interfaces No interfaces are defined.

[Add](#)

Description

Monitored by proxy

Enabled

- In the *Macros* tab, set the following host macros:
 - `{VMWARE.URL}` - VMware service (vCenter or ESXi hypervisor) SDK URL (`https://servername/sdk`)
 - `{VMWARE.USERNAME}` - VMware service user name
 - `{VMWARE.PASSWORD}` - VMware service `{VMWARE.USERNAME}` user password

New host ? X

Host IPMI Tags **Macros 3** Inventory Encryption Value mapping

Host macros Inherited and host macros

Macro	Value		Description	
<code>{VMWARE.URL}</code>	<code>https://servername/sdk</code>	<input type="button" value="T"/>	description	<input type="button" value="Remove"/>
<code>{VMWARE.USERNAME}</code>	<code>username</code>	<input type="button" value="T"/>	description	<input type="button" value="Remove"/>
<code>{VMWARE.PASSWORD}</code>	<code>*****</code>	<input type="button" value="E"/>	description	<input type="button" value="Remove"/>

[Add](#)

3. Click the *Add* button to create the host. This host will represent your VMware environment.

View collected metrics

Congratulations! At this point, Zabbix is already monitoring your VMware environment.

Depending on the configuration of your VMware environment, Zabbix may **discover** and then create hosts for the discovered entities. Note that the discovery and creation of hosts can also be **executed manually**, if necessary.

To view created hosts, navigate to the *Data collection* → *Hosts* menu section.

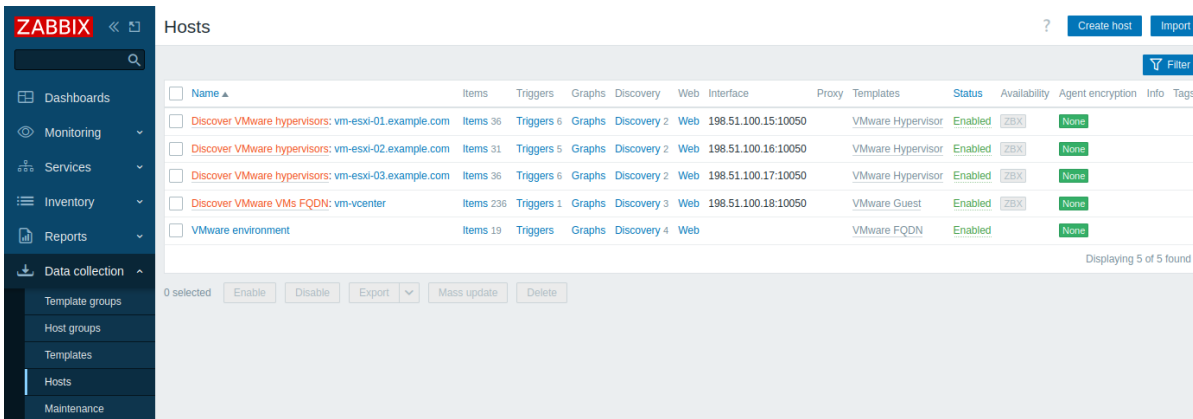

To view collected metrics, navigate to the **Monitoring** → **Hosts** menu section and click **Latest data** next to the created "VMware environment" host or one of the hosts that were created for the discovered entities.

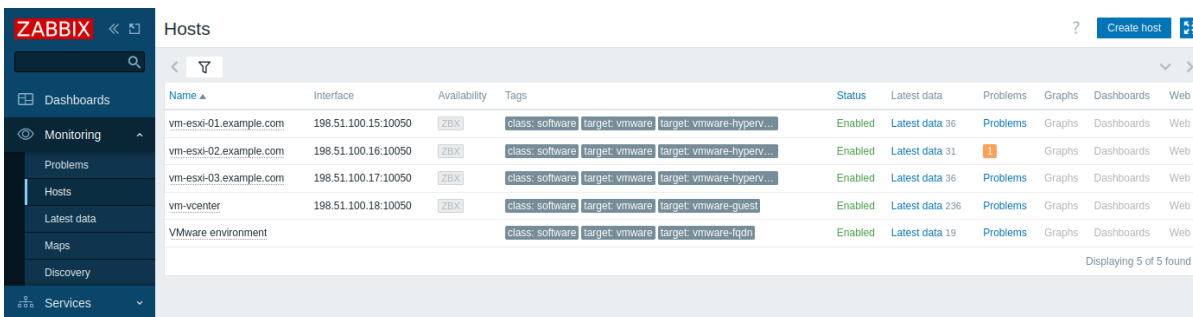

This action will open a list of all the latest metrics collected from the selected host.

Host	Name	Last check	Last value	Change	Tags	Info
VMware environment	VMware: Average read latency of the datasto...	4s	0		component: datastore; datastore: esxi-01-ds...	Graph
VMware environment	VMware: Average read latency of the datasto...	3s	0		component: datastore; datastore: esxi-02-ds...	Graph
VMware environment	VMware: Average read latency of the datasto...	2s	0		component: datastore; datastore: esxi-03-ds...	Graph
VMware environment	VMware: Average read latency of the datasto...				component: datastore; datastore: vsanData...	Graph
VMware environment	VMware: Average write latency of the datasto...	52s	0		component: datastore; datastore: esxi-01-ds...	Graph
VMware environment	VMware: Average write latency of the datasto...	51s	0		component: datastore; datastore: esxi-02-ds...	Graph
VMware environment	VMware: Average write latency of the datasto...	50s	0		component: datastore; datastore: esxi-03-ds...	Graph
VMware environment	VMware: Average write latency of the datasto...				component: datastore; datastore: vsanData...	Graph
VMware environment	VMware: Event log	17s	User EXAMPLE...		component: log	History
VMware environment	VMware: Free space on datastore esxi-01-ds-...	4m	85.8699 %		component: datastore; datastore: esxi-01-ds...	Graph
VMware environment	VMware: Free space on datastore esxi-02-ds-...	3m 59s	55.9377 %		component: datastore; datastore: esxi-02-ds...	Graph
VMware environment	VMware: Free space on datastore esxi-03-ds-...	3m 58s	99.4085 %		component: datastore; datastore: esxi-03-ds...	Graph
VMware environment	VMware: Free space on datastore vsanData...	4m 1s	0 %		component: datastore; datastore: vsanData...	Graph
VMware environment	VMware: Full name	14m 16s	VMware vCente...		component: system	History
VMware environment	VMware: Total size of datastore esxi-01-ds-iv...	3m 56s	238.25 GB		component: datastore; datastore: esxi-01-ds...	Graph
VMware environment	VMware: Total size of datastore esxi-02-ds-iv...	3m 55s	238.25 GB		component: datastore; datastore: esxi-02-ds...	Graph
VMware environment	VMware: Total size of datastore esxi-03-ds-iv...	3m 54s	238.25 GB		component: datastore; datastore: esxi-03-ds...	Graph
VMware environment	VMware: Total size of datastore vsanDatastore	3m 57s	0 B		component: datastore; datastore: vsanData...	Graph
VMware environment	VMware: Version	14m 15s	8.0.1		component: system	History

Note that some items have no data and the *Not supported* state. This is because Zabbix cannot find valid performance counters on the specific datastore, as it is not enabled in the VMware environment being monitored.

Set up problem alerts

Zabbix can notify you about a problem with your infrastructure using a variety of methods. This guide provides basic configuration steps for sending email alerts.

1. Navigate to **User settings** → **Profile**, switch to the **Media** tab and add your email.

Media



Type

* Send to [Remove](#)

[Add](#)

* When active

Use if severity Not classified
 Information
 Warning
 Average
 High
 Disaster

Enabled

Add

Cancel

2. Follow the guide for [Receiving a problem notification](#).

Next time, when Zabbix detects a problem, you should receive an alert via email.

See also

- [Creating an item](#) - how to start monitoring additional metrics.
- [Problem escalations](#) - how to create multi-step alert scenarios (e.g., first send message to the system administrator, then, if a problem is not resolved in 45 minutes, send message to the data center manager).
- [Virtual machine monitoring](#) - additional information about VMware monitoring (data collection process, server configuration options, troubleshooting guidance, etc.).
- [VMware monitoring item keys](#) - a full list of VMware metrics that can be monitored using Zabbix.
- Template [VMware](#) - additional information about the *VMware* template.
- Template [VMware FQDN](#) - additional information about the *VMware FQDN* template.

6 Monitor network traffic with Zabbix

Introduction This page walks you through the steps required to start basic monitoring of your network traffic with Zabbix.

Who this guide is for

This guide is designed for new Zabbix users and contains the minimum set of steps required to enable basic monitoring of your network traffic. If you are looking for deep customization options or require more advanced configuration, see the [Configuration](#) section of Zabbix manual.

Prerequisites

Before proceeding with this guide, you need to [download and install](#) Zabbix server, Zabbix frontend and Zabbix agent according to the instructions for your OS. As a starting point, the [Installation from packages](#), followed by the [Web interface installation](#), would be the advised solution. Note that you should install Zabbix agent on the machine that requires traffic monitoring. This can be either the same host where Zabbix server is installed or a different host.

This guide will provide the instructions on configuring the network traffic monitoring of *eth0* interface on a separate machine named *Remote host*.

Configure Zabbix for monitoring Zabbix agent can collect metrics in active or passive mode (simultaneously). See [Passive and active agent checks](#) for more info. In this guide, monitoring by means of passive checks will be described.

Configuring Zabbix agent

1. Open the agent configuration file on the machine where the agent is installed (by default, the path is `/usr/local/etc/zabbix_agentd.conf`):

```
sudo vi /usr/local/etc/zabbix_agentd.conf
```

2. Add the IP address or DNS name of your Zabbix server to the `Server` parameter. For example:

```
Server=192.0.2.22
```

3. Restart Zabbix agent:

```
systemctl restart zabbix-agent
```

Zabbix frontend

1. Log into Zabbix frontend.

2. **Create a host** in Zabbix web interface, specifying the IP address or DNS name of the machine on which the agent is installed.

Interfaces	Type	IP address	DNS name	Connect to	Port	Default
Agent		192.0.2.255		IP	10050	<input checked="" type="radio"/> Remove

Create items Follow the instructions on [creating an item](#) to add the items for traffic monitoring, namely:

- Incoming traffic
- Outgoing traffic
- Total traffic

A simple setup for the incoming traffic monitoring item would look as follows:

* Name Incoming traffic

Type Zabbix agent

* Key net.if.in[eth0] Select

Type of information Numeric (unsigned)

* Host interface 192.0.2.255:10050

Units bps

* Update interval 10s

To make the collected data suitable for practical use, you can set some **preprocessing** steps when creating the items. In the given case, those can be multiplication by 8 (to convert bytes to bits) and presentation as change per second.

Item Tags **Preprocessing 2**

Preprocessing steps	Name	Parameters
1:	Custom multiplier	8
2:	Change per second	

[Add](#)

Type of information: **Numeric (unsigned)**

[Add](#) [Test](#) [Cancel](#)

View collected data Congratulations! At this point, Zabbix is already monitoring your network traffic.

To view collected metrics, open the *Monitoring* → *Hosts* menu section and click on the *Latest data* in the row of the host.

Name ▲	Interface	Availability	Tags	Status	Latest data
Remote host	192.0.2.255:10050	ZBX		Enabled	Latest data 3

You will see the traffic data.

<input type="checkbox"/> Host	Name ▲	Last check	Last value	Change	Tags	Info	
<input type="checkbox"/>	Remote host	Incoming traffic	10s	2.02 Mbps	+1.63 Mbps	component: network	Graph
<input type="checkbox"/>	Remote host	Outgoing traffic	9s	36.69 Kbps	+26.03 Kbps	component: network	Graph
<input type="checkbox"/>	Remote host	Total traffic	8s	1.28 Mbps	-23.43 Kbps	component: network	Graph

Displaying 3 of 3 found

View graphs The data collected can be displayed as **graphs**. To view those, in the *Latest data* section click on *Graph* in the row of the item or select required items and click on *Display graph* below.

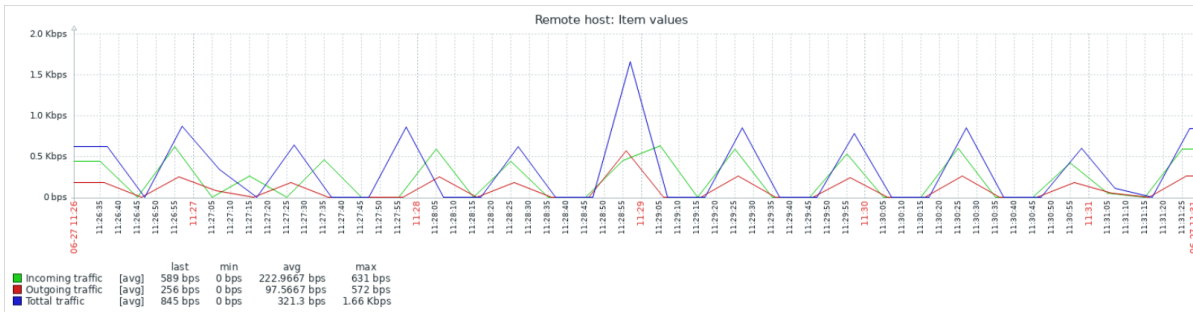

Configure triggers You can set **triggers** to detect abnormal network traffic. See the instructions on **configuring a trigger** and add the trigger signalling that the total traffic is too high, for example:

Trigger Tags Dependencies

* Name:

Event name:

Operational data:

Severity: Not classified Information Warning Average High Disaster

* Expression: [Add](#)

[Expression constructor](#)

Now make the traffic exceed the threshold you have set in the trigger expression and navigate to the *Monitoring* → *Problems* to check that the problem is listed there.

<input type="checkbox"/>	Time ▾	Severity	Recovery time	Status	Info	Host	Problem
<input type="checkbox"/>	17:36:27	Warning		PROBLEM		Remote host	High total traffic

Set up problem alerts There are several ways of getting notifications about the problem. Email being the most popular one, follow the instructions on setting up a [problem notification](#) via email. You can also choose other [media types](#) to be used for the notification delivery.

See also:

- [Problem escalations](#) - how to create multi-step alert scenarios (e.g., first send message to the system administrator, then, if a problem is not resolved in 45 minutes, send message to the data center manager).
- [Problem acknowledgment](#) - how to indicate that the problem is known, make comments on resolving it, suppress or close the problem.
- [Monitor Linux with Zabbix agent](#) - how to start basic monitoring of the most important items by linking a pre-configured template.

7 Monitor network traffic using active checks

Introduction This page walks you through the steps required to start basic monitoring of your network traffic with Zabbix using active checks.

Who this guide is for

This guide is designed for new Zabbix users and contains the minimum set of steps required to enable basic monitoring of your network traffic using active checks. If you are looking for deep customization options or require more advanced configuration, see the [Configuration](#) section of Zabbix manual.

Prerequisites

Before proceeding with this guide, you need to [download and install](#) Zabbix server, Zabbix frontend and Zabbix agent according to the instructions for your OS. As a starting point, the [Installation from packages](#), followed by the [Web interface installation](#), would be the advised solution. Note that you should install Zabbix agent on the machine that requires traffic monitoring. This can be either the same host where Zabbix server is installed or a different host.

This guide will provide the instructions on configuring the network traffic monitoring of *eth0* interface on a separate machine named *Remote host*.

Configure Zabbix for monitoring Zabbix agent can collect metrics in active or passive mode (simultaneously). See [Passive and active agent checks](#) for more info. In this guide, monitoring by means of **active checks** will be described.

Configuring Zabbix agent

1. Open the agent configuration file on the machine where the agent is installed (by default, the path is */usr/local/etc/zabbix_agentd.conf*):

```
sudo vi /usr/local/etc/zabbix_agentd.conf
```

2. Add the IP address or DNS name of your Zabbix server to the *ServerActive* parameter. For example:

```
ServerActive=192.0.2.22
```

3. Define the *Hostname* parameter - it must match the host name defined in Zabbix frontend. In our example, it is:

```
Hostname=Remote host
```

4. Restart Zabbix agent:

```
systemctl restart zabbix-agent
```

Zabbix frontend

1. Log into Zabbix frontend.
2. [Create a host](#) in Zabbix web interface, specifying the IP address or DNS name of the machine on which the agent is installed.

Make sure the field *Host name* matches the *Hostname* parameter defined in the agent configuration file.

New host

Host IPMI Tags Macros Inventory Encryption Value mapping

* Host name

Visible name

Templates

* Host groups

Interfaces	Type	IP address	DNS name	Connect to	Port	Default
Agent		<input type="text" value="192.0.2.255"/>	<input type="text"/>	<input checked="" type="radio"/> IP <input type="radio"/> DNS	<input type="text" value="10050"/>	<input checked="" type="radio"/> Remove

Create items Follow the instructions on [creating an item](#) to add the items for traffic monitoring, namely:

- Incoming traffic
- Outgoing traffic
- Total traffic

A simple setup for the incoming traffic monitoring item with an active check would look as follows:

Item Tags Preprocessing

* Name

Type

* Key

Type of information

Units

* Update interval

To make the collected data suitable for practical use, you can set some [preprocessing](#) steps when creating the items. In the given case, those can be multiplication by 8 (to convert bytes to bits) and presentation as change per second.

Item Tags Preprocessing 2

Preprocessing steps	Name	Parameters
1:	<input type="text" value="Custom multiplier"/>	<input type="text" value="8"/>
2:	<input type="text" value="Change per second"/>	

[Add](#)

Type of information

View collected data Congratulations! At this point, Zabbix is already monitoring your network traffic.

To view collected metrics, open the [Monitoring](#) → [Hosts](#) menu section and click on the *Latest data* in the row of the host.

Name ▲	Interface	Availability	Tags	Status	Latest data
Remote host	192.0.2.255:10050	<input type="button" value="ZBX"/>		Enabled	Latest data 3

You will see the traffic data.

Host	Name ▲	Last check	Last value	Change	Tags	Info
<input type="checkbox"/>	Remote host	Incoming traffic (active check)	10s	2.02 Mbps	+1.63 Mbps	component: network Graph
<input type="checkbox"/>	Remote host	Outgoing traffic (active check)	9s	36.69 Kbps	+26.03 Kbps	component: network Graph
<input type="checkbox"/>	Remote host	Total traffic (active check)	8s	1.28 Mbps	-23.43 Kbps	component: network Graph

Displaying 3 of 3 found

See also:

- [View graphs](#) - how to display the collected data as graphs.
- [Configure triggers](#) - how to set up triggers to detect abnormal network traffic.
- [Set up problem alerts](#) - how to set up notifications about problem situations.
- [Problem escalations](#) - how to create multi-step alert scenarios (e.g., first send message to the system administrator, then, if a problem is not resolved in 45 minutes, send message to the data center manager).
- [Problem acknowledgment](#) - how to indicate that the problem is known, make comments on resolving it, suppress or close the problem.
- [Monitor Linux with Zabbix agent](#) - how to start basic monitoring of the most important items by linking a pre-configured template.

8 Monitor websites with Browser items

Introduction

This page walks you through the steps required to start basic monitoring of websites with Browser items.

Who this guide is for

This guide is designed for new Zabbix users and contains the minimum set of steps required to enable basic monitoring of websites with Browser items. If you are looking for deep customization options or require more advanced configuration, see the [Browser items](#) page or the [Configuration](#) section of Zabbix manual.

Prerequisites

Before proceeding with this guide, you need to [download and install](#) Zabbix server and Zabbix frontend according to the instructions for your OS.

This guide is based on the following setup:

- Zabbix version: 7.2 PRE-RELEASE (installed from packages)
- OS distribution: Ubuntu
- OS version: 22.04 (Jammy)
- Zabbix components: Server, Frontend, Agent
- Database: MySQL
- Web server: Apache

Configure WebDriver

Browser items require an automation framework (either Selenium Server or a plain WebDriver, for example, ChromeDriver) as a web testing endpoint that controls and interacts with a browser, executing test commands such as clicking buttons or entering text. As an example, this guide will use Selenium Server with Chrome in a Docker container.

It is assumed that Docker is already configured. This guide does not cover the configuration of Docker. For installation instructions, see [Install Docker Engine on Ubuntu](#).

1. Launch Selenium Server with Chrome in a Docker container with the following options:

- `docker run --name browser` - runs a new Docker container named "browser";
- `-p 4444:4444` - maps port 4444 on your host machine to port 4444 on the container (this is the port used by Selenium Server to accept commands);
- `-p 7900:7900` - maps port 7900 on your host machine to port 7900 on the container (this is the port used by the Virtual Network Computing (VNC) server, allowing you to view the browser GUI remotely; requires a VNC client);
- `--shm-size="2g"` - allocates 2GB of shared memory to the container (this is important for Chrome to run properly, as it can require a significant amount of shared memory to avoid crashes);
- `-d` - runs the container in detached mode, meaning it will run in the background;
- `selenium/standalone-chrome:latest` - specifies the Docker image to use; in this case, the latest version of [Selenium Server with Chrome](#).

```
docker run --name browser \  
-p 4444:4444 \  
-p 7900:7900 \  
--shm-size="2g" \  
-d selenium/standalone-chrome:latest
```

2. Ensure that the browser Docker container is running and accessible.

- Retrieve the IP address of the container (in this example, 192.0.2.1):

```
ip addr
```

```
### 1: lo: <LOOPBACK,UP,LOWER_UP>
### ...
### 3: docker0: <NO-CARRIER,BROADCAST,MULTICAST,UP> ...
###   inet 192.0.2.1/16 brd 192.0.255.255 scope global docker0
### ...
```

- Test the connection to the container with [Ncat](#):

```
nc -zv 192.0.2.1 4444
```

```
### Connection to 192.0.2.1 4444 port [tcp/*] succeeded!
```

- Retrieve the webpage content from Selenium Server with [curl](#):

```
curl -L 192.0.2.1:4444
```

```
### <!DOCTYPE html>
### <html lang="en">
###
### <head>
###   <meta charset="utf-8"/>
###   <link href="favicon.svg" rel="icon" type="image/svg">
###   <meta content="width=device-width, initial-scale=1" name="viewport"/>
###   <link href="logo192.png" rel="apple-touch-icon"/>
###   <link href="manifest.json" rel="manifest"/>
###   <title>Selenium Grid</title>
### </head>
###
### <body>
### ...
```

Note:

For troubleshooting, refer to [Docker documentation](#).

Configure Zabbix server

Browser items are executed and processed by *browser poller* Zabbix processes that need to be enabled by adjusting the **StartBrowserPollers** server configuration parameter. Additionally, the **WebDriverURL** parameter should specify the previously configured web testing endpoint.

By default, the **StartBrowserPollers** parameter is set to 1, therefore you only need to specify the web testing endpoint.

1. Open the Zabbix server configuration file.

```
vi /etc/zabbix/zabbix_server.conf
```

2. Locate and set the **WebDriverURL** parameter in Zabbix server configuration file:

```
##### Option: WebDriverURL
###WebDriver interface HTTP[S] URL. For example http://localhost:4444 used with Selenium WebDriver standard
###
### Mandatory: no
### Default:
### WebDriverURL=

WebDriverURL=192.0.2.1:4444
```

3. Restart Zabbix server.

```
systemctl restart zabbix-server
```

Configure Zabbix frontend

1. Log into Zabbix frontend.

2. **Create a host** in Zabbix web interface:

- In the *Host name* field, enter a host name (for example, "git.zabbix.com").

- In the *Templates* field, type or select the "Website by Browser" template. For more information on this template, see [Website by Browser](#).
- In the *Host groups* field, type or select a host group (for example, a new host group "Websites").

New host ? x

Host IPMI Tags Macros Inventory Encryption Value mapping

* Host name

Visible name

Templates Select
type here to search

* Host groups Select
type here to search

Interfaces No interfaces are defined.
[Add](#)

Description

Monitored by Server Proxy Proxy group

Enabled

[Add](#) [Cancel](#)

- In the *Macros* tab, switch to *Inherited and host macros*, look for the following macros and click on *Change* next to the macro value to update it:
 - `{$WEBSITE.DOMAIN}` - Domain name (for example, git.zabbix.com/projects/ZBX/repos/zabbix/browse)
 - `{$WEBSITE.GET.DATA.INTERVAL}` - Item data update interval (for example, 15m)

New host ? x

Host IPMI Tags **Macros 2** Inventory Encryption Value mapping

Host macros **Inherited and host macros**

Macro	Effective value	Template value	Global value (configure)
<code>{\$SNMP_COMMUNITY}</code>	public	T	= "public"
<code>{\$WEBSITE.BROWSER}</code>	chrome	T	= Website by Browser: "chrome"
<code>{\$WEBSITE.DOMAIN}</code>	git.zabbix.com/projects/ZBX/repos/zabbix/browse	T	= Website by Browser: "www.example.com"
<code>{\$WEBSITE.GET.DATA.INTERVAL}</code>	15m	T	= Website by Browser: "0s;m/15"
<code>{\$WEBSITE.NAVIGATION.LOAD.MAX.WARN}</code>	5	T	= Website by Browser: "5"
<code>{\$WEBSITE.PATH}</code>	value	T	= Website by Browser: ""
<code>{\$WEBSITE.RESOURCE.LOAD.MAX.WARN}</code>	5	T	= Website by Browser: "5"

[Add](#) [Cancel](#)

3. Click the *Add* button to create the host. This host will represent the website you want to monitor.

View collected metrics

Congratulations! At this point, Zabbix is already monitoring the website you specified.

To view collected metrics, navigate to the *Monitoring* → *Hosts* menu section and click on *Dashboards* next to the host.

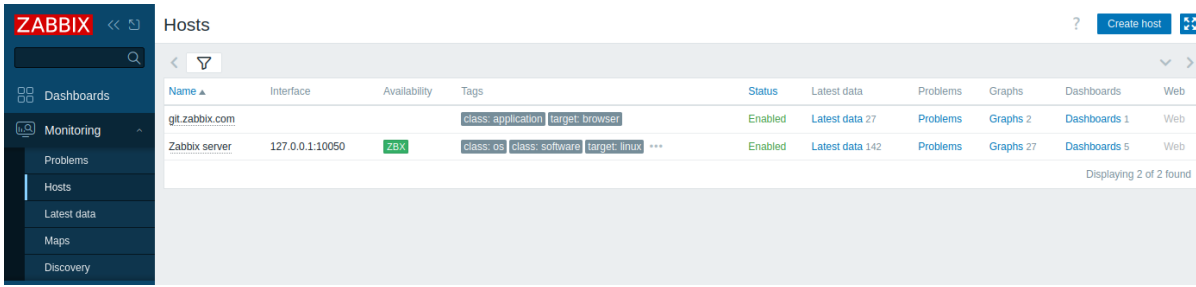

This action will take you to the host dashboard (configured on the template level) with the most important metrics collected from the website.

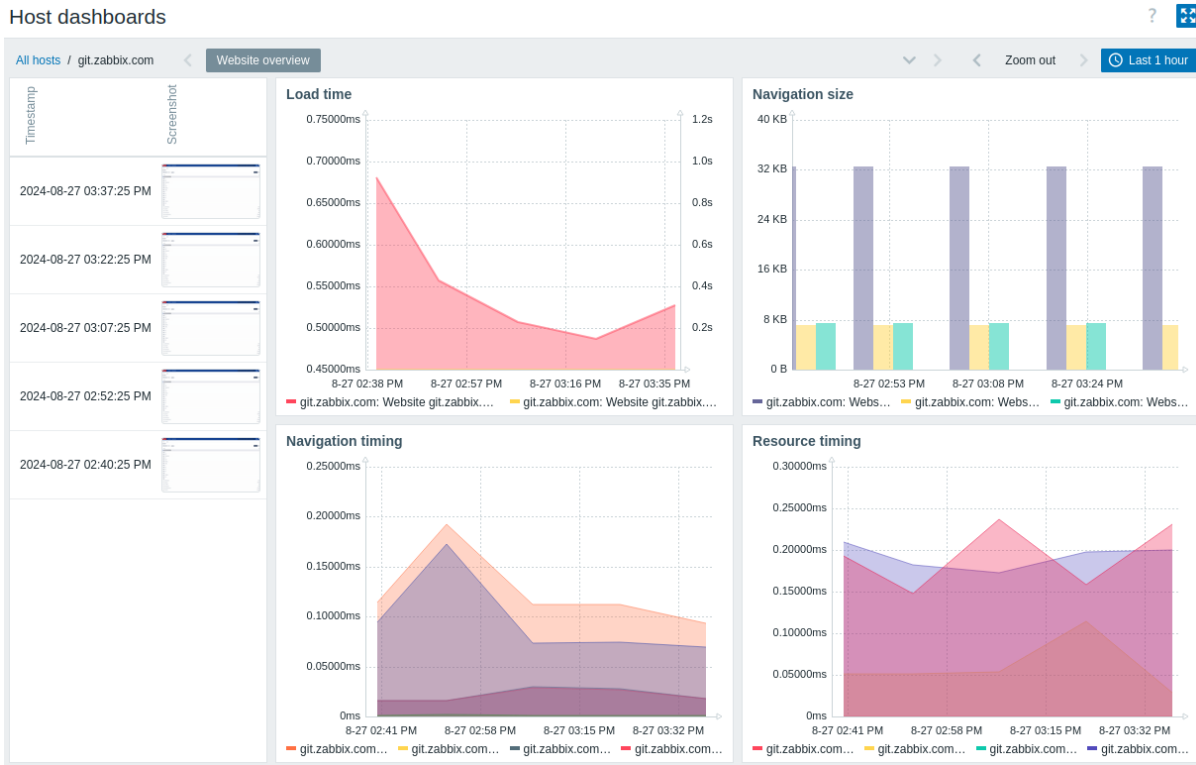

Set up problem alerts

Zabbix can notify you about a problem with your infrastructure using a variety of methods. This guide provides basic configuration steps for sending email alerts.

1. Navigate to *User settings* → *Profile*, switch to the *Media* tab and **add your email**.

Media



Type

* Send to [Remove](#)

[Add](#)

* When active

Use if severity Not classified
 Information
 Warning
 Average
 High
 Disaster

Enabled

Add

Cancel

2. Follow the guide for [Receiving a problem notification](#).

Next time, when Zabbix detects a problem, you should receive an alert via email.

Test your configuration

To test your configuration, we can simulate a real problem by updating the host configuration in Zabbix frontend.

1. Open your website host configuration in Zabbix.
2. Switch to the *Macros* tab and select *Inherited and host macros*.
3. Click on *Change* next to, for example, the *previously configured* `{$WEBSITE.DOMAIN}` macro value and set an incorrect domain name (for example, `/git.zabbix.com/projects/ZBX/repos/zabbix/browse`).
4. Click on *Update* to update the host configuration.
5. In a few moments, Zabbix will detect the problem "Failed to get JSON of the requested website", because it will not be able to connect to the specified website. The problem will appear in *Monitoring* → *Problems*.

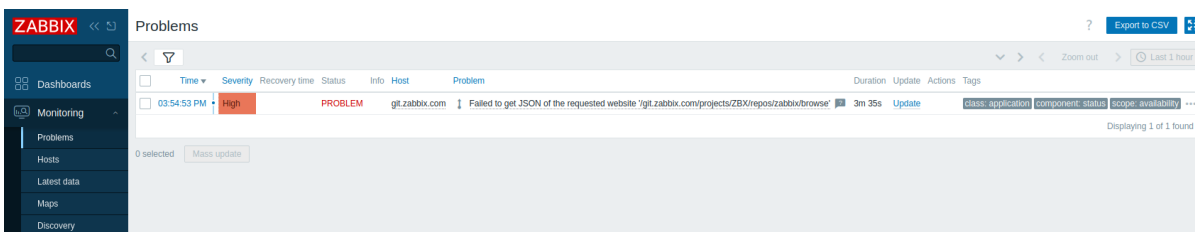

If alerts are [configured](#), you will also receive the problem notification.

6. Change the macro value back to its previous value to resolve the problem and continue monitoring the website.

See also

- [Creating an item](#) - how to start monitoring additional metrics.
- [Problem escalations](#) - how to create multi-step alert scenarios (e.g., first send message to the system administrator, then, if a problem is not resolved in 45 minutes, send message to the data center manager).
- [Browser items](#) - how to configure Browser items.
- Template [Website by Browser](#) - additional information about the *Website by Browser* template.

Developer Center

This section contains everything you need to quickly start developing custom Zabbix extensions:

- [Frontend modules](#)
- [Dashboard widgets](#)
- [Plugins](#) for Zabbix agent 2

Copyright notice

Zabbix documentation is NOT distributed under the AGPL-3.0 license. Use of Zabbix documentation is subject to the following terms:

You may create a printed copy of this documentation solely for your own personal use. Conversion to other formats is allowed as long as the actual content is not altered or edited in any way. You shall not publish or distribute this documentation in any form or on any media, except if you distribute the documentation in a manner similar to how Zabbix disseminates it (that is, electronically for download on a Zabbix web site) or on a USB or similar medium, provided however that the documentation is disseminated together with the software on the same medium. Any other use, such as any dissemination of printed copies or use of this documentation, in whole or in part, in another publication, requires the prior written consent from an authorized representative of Zabbix. Zabbix reserves any and all rights to this documentation not expressly granted above.

Modules

What is a PHP frontend module?

- A module is an entity with a unique ID, name, description, author, and other fields defined in its manifest file, along with PHP, Javascript and other files located in a single directory inside the *modules* directory of your Zabbix frontend installation (for example, *zabbix/ui/modules*).
- A module should conform to simple rules to guarantee correct operation.
- A module must be installed (unpacked) and enabled in the frontend by the administrator.

What a module can be used for

- Adding new functionality via custom frontend sections;
- Creating custom dashboard widget types (see [widget modules](#));
- Overriding or extending the existing functionality.

What a module cannot be used for

- Registering a new API method or modifying an existing one.

How modules work

- An enabled module is launched on each HTTP request, before executing the action code.
- The module will register new actions or redefine the existing ones.
- The module will add new frontend sections and remove or redefine the existing ones.
- The module will hook to frontend events like `onBeforeAction` and `onTerminate`, if needed.
- The requested action is finally executed by running the action code - either the default one, or module-defined.

Where to go next Whether you prefer to learn by doing or read the guidelines first, these pages contain the information and steps required to build your own modules:

- [Step-by-step tutorials for writing your first module](#)
- [Module file structure](#)
- [Widget module specifics](#)
- [Module examples to reuse](#)

Module file structure

All code related to a module is stored in a single directory inside the **modules** directory of your Zabbix frontend installation (for example, *zabbix/ui/modules*).

example_module_directory/	(required)	
manifest.json	(required)	Metadata and action definition.
Module.php		Module initialization and event handling.
actions/		Action controller files.
SomethingView.php		
SomethingCreate.php		
SomethingDelete.php		
data_export/		
ExportAsXml.php		
ExportAsExcel.php		
views/		View files.
example.something.view.php		
example.something.delete.php		
assets/		Any additional files to be used in views. Must be specified
js/		JavaScript files used in views.
example.something.view.js.php		
css/		CSS files used in views.
example.something.css		
image.png		Images used in views.
example.something.file		Any file for using in views.

Module file tree

Writing a module A sample module writing process consists of the following steps (where available, click on the file or folder name to view additional details about the step):

1. Create a new directory for the module inside **zabbix/ui/modules/**.
2. Add **manifest.json** file with module metadata.
3. Create **views** folder and define a module view(s).
4. Create **actions** folder and define a module action(s).
5. Create **Module.php** (or **Widget.php** for dashboard widgets) file and define initialization and event handling rules.
6. Create **assets** folder for JavaScript files (place into **assets/js**), CSS styles (place into **assets/css**), or any other additional files.
7. Make sure to specify required views, actions and asset files in the **manifest.json**.
8. **Register** the module in Zabbix frontend and start using it.

Note:

You can register and enable a module as soon as you create **manifest.json** file. Once the module is enabled, you can preview all changes made to module files immediately by refreshing Zabbix frontend.

manifest.json

Any module needs the **manifest.json** file. The file must be located in the module's primary directory (for example, **zabbix/ui/modules/module_name/manifest.json**).

As a bare minimum, **manifest.json** should specify these fields:

```
{
  "manifest_version": 2.0,
  "id": "my_ip_address",
  "name": "My IP Address",
  "namespace": "MyIPAddress",
  "version": "1.0"
}
```

Parameters supported in **manifest.json** (press on the parameter name for a detailed description):

Parameter	Description	Required
manifest_version	Manifest version of the module.	Yes
id	Unique module ID.	
name	Module name that will be displayed in the Administration section.	
namespace	PHP namespace for module classes.	
version	Module version.	

Parameter	Description	Required
<code>type</code>	Type of the module. For widget must be set to <i>widget</i>	Yes for widgets, otherwise no
<code>widget</code>	Widget configuration. Used for widgets only.	
<code>actions</code>	Actions to register with the module.	
<code>assets</code>	CSS styles and JavaScript files to include.	No
<code>author</code>	Module author.	
<code>config</code>	Default values for custom module options.	
<code>description</code>	Module description.	
<code>url</code>	A link to the module description.	

`manifest_version`

Manifest version of the module. Currently, supported version is **2.0**.

Type: Double

Example:

```
"manifest_version": 2.0
```

`id`

Module ID. Must be unique. To avoid future naming conflicts, it is recommended to use prefix for modules (author or company name, or any other). For example, if a module is an example for lessons and the module name is "My module", then the ID will be "example_my_module".

Type: String

Example:

```
"id": "example_my_module"
```

`name`

Module name that will be displayed in the Administration section.

Type: String

Example:

```
"name": "My module"
```

`namespace`

PHP namespace for module classes.

Type: String

Example:

```
"namespace": "ClockWidget"
```

`version`

Module version. The version will be displayed in the Administration section.

Type: String

Example:

```
"version": "1.0"
```

`type`

Type of the module. Required for widgets and must equal "widget".

Type: String

Default: "module"

Example:

```
"type": "widget"
```

actions

Actions to register with the module. Defining *class* object key for each action is required, other action keys are optional.

Type: Object

Supported object keys if *type* is *module*:

- **write.your.action.name** (object) - action name, should be written in lowercase [a-z], separating words with dots. Supports the keys:
 - **class** (string; required) - action class name.
 - **layout** (string) - action layout. Supported values: *layout.json*, *layout.htmlpage* (default), *null*.
 - **view** (string) - action view.

Example:

```
"actions": {
  "module.example.list": {
    "class": "ExampleList",
    "view": "example.list",
    "layout": "layout.htmlpage"
  }
}
```

Supported object keys if *type* is *widget*:

- **widget.{id}.view** (object) - file and class name for widget view. Replace **{id}** with the widget's *id* value (for example, *widget.example_clock.view*). Supports the keys:
 - **class** (string; required) - action class name for widget view mode to extend the default *CControllerDashboardWidgetView* class. The class source file must be located in the *actions* directory.
 - **view** (string) - widget view. Must be located in the *views* directory. If the view file is *widget.view.php*, which is expected by default, this parameter maybe omitted. If using a different name, specify it here.
- **widget.{id}.edit** (object) - file name for widget configuration view. Replace **{id}** with the widget's *id* value (for example, *widget.example_clock.edit*). Supports the keys:
 - **class** (string; required) - action class name for widget configuration view mode. The class source file must be located in the *actions* directory.
 - **view** (string) - widget configuration view. Must be located in the *views* directory. If the view file is *widget.edit.php*, which is expected by default, this parameter maybe omitted. If using a different name, specify it here.

Example:

```
"actions": {
  "widget.tophosts.view": {
    "class": "WidgetView"
  },
  "widget.tophosts.column.edit": {
    "class": "ColumnEdit",
    "view": "column.edit",
    "layout": "layout.json"
  }
}
```

assets

CSS styles and JavaScript files to include.

Type: Object

Supported object keys:

- **css** (array) - CSS files to include. The files must be located in the *assets/css*.
- **js** (array) - JavaScript files to include. The files must be located in the *assets/js*.

Example:

```
"assets": {
  "css": ["widget.css"],
  "js": ["class.widget.js"]
}
```

author

Module author. The author will be displayed in the Administration section.

Type: String

Example:

```
"author": "John Smith"
```

config

Default values for the module options. The object may contain any custom keys. If specified, these values will be written into the database during module registration. New variables added later will be written upon the first call. Afterwards, the variable values can only be changed directly in the database.

Type: Object

Example:

```
"config": {
  "username": "Admin",
  "password": "",
  "auth_url": "https://example.com/auth"
}
```

description

Module description.

Type: String

Example:

```
"description": "This is a clock widget."
```

widget

Widget configuration. Used, if *type* is set to *widget*.

Type: Object

Supported object keys:

- **name** (string) - used in the widget list and as default header. If empty, "name" parameter from the module will be used.
- **size** (object) - default widget dimensions. Supports keys:
 - *width* (integer) - default widget width.
 - *height* (integer) - default widget height.
- **form_class** (string) - class with widget fields form. Must be located in the *includes* directory. If the class is *WidgetForm.php*, which is expected by default, this parameter maybe omitted. If using a different name, specify it here.
- **js_class** (string) - name of a JavaScript class for widget view mode to extend the default *CWidget* class. The class will be loaded with the dashboard. The class source file must be located in the *assets/js* directory. See also: [assets](#).
- **use_time_selector** (boolean) - determines whether the widget requires dashboard time selector. Supported values: *true*, *false* (default).
- **refresh_rate** (integer) - widget refresh rate in seconds (default: 60).

Example:

```
"widget": {
  "name": "",
  "size": {
    "width": 12,
    "height": 5
  },
  "form_class": "WidgetForm",
  "js_class": "CWidget",
  "use_time_selector": false,
  "refresh_rate": 60
}
```

url

A link to the module description. For widgets, this link will be opened when clicking on the help icon  in the *Add widget* or *Edit widget* window. If **url** is not specified, clicking on the help icon will open the general *Dashboard widgets* page.

Type: String

Example:

```
"url": "http://example.com"
```

Actions

Actions are responsible for 'business logic' of the module. An action usually consists of a **controller** and an **action view**.

A module can:

- Call actions that are already defined in Zabbix frontend.
- Override default actions with custom actions.
- Define completely new actions.

To override a default action behavior with some custom behavior, define an action with the same name in the module configuration. When the action is called, the module action will be executed instead of the default Zabbix action.

Action files should be stored in the *actions* folder. The actions need to be specified in the *manifest.json*.

Controller

Action controller workflow:

- 1) Check that all parameters passed in an HTTP request are valid:
 - Call the controller's *checkInput()* method
 - Use validation rules defined in *CNewValidator.php*
 - Call *validateInput()* method
- 2) Check user permissions.
- 3) Prepare the data according to passed parameters: if *checkInput()* returns true, Zabbix calls the controller's *doAction()* method.
- 4) Prepare the **\$data** array for the view. Use *CControllerResponseData* and *setResponse()* method to store response in the **\$data** array.

Example:

```
/**
 * Validate input parameters.
 *
 * @return bool
 */
protected function checkInput(): bool {
    $ret = $this->validateInput([
        'status' => 'in '.implode(',', [HOST_STATUS_MONITORED, HOST_STATUS_NOT_MONITORED])
    ]);

    if (!$ret) {
        $this->setResponse(new CControllerResponseFatal());
    }

    return $ret;
}

/**
 * Check user permissions.
 *
 * @return bool
 */
protected function checkPermissions() {
    return $this->getUserType() >= USER_TYPE_ZABBIX_ADMIN;
}
```

```

/**
 * Execute action and generate response object.
 */
protected function do Action(): void {
    $data = [
        'hosts_count' => API::Host()->get([
            'countOutput' => true,
            'filter' => [
                'status' => $this->getInput('status')
            ]
        ])
    ];

    $this->setResponse(new CControllerResponseData($data));
}

```

Note:

You can view the full list of available controller classes in Zabbix [source code](#).

Views

View file receives the data from a controller and then prepares the HTML look of it.

Note:

Defining view(s) for a frontend module is optional, unless the module is a widget.

Dashboard widgets need at least two views: one for the edit mode and one for the view mode (should be stored in the views directory).

It is possible to use pre-defined Zabbix HTML classes (from the `/zabbix/ui/include/classes/html`) in the view as well as add new HTML and CSS classes. New classes should be stored in the module's `assets` folder.

Example:

```

...
(new CColHeader(_('Name')))

```

This will add a new column name *Name* and style the top table row as on other Zabbix pages.

Action view

This is a reference file for defining an action view.

```

<?php declare(strict_types = 1);

/**
 * @var CView $this
 */

$this->includeJsFile('example.something.view.js.php');

(new CWidget())
    ->setTitle(_('Something view'))
    ->addItem(new CDiv($data['name']))
    ->addItem(new CPartial('module.example.something.reusable', [
        'contacts' => $data['contacts']
    ]))
    ->show();

```

Assets

The folder `assets` may contain any files and subfolders that do not belong to other directories. You can use it for:

- JavaScript styles (must be inside `assets/js`);
- CSS styles (must be inside `assets/css`);

- Images;
- Fonts;
- Anything else you need to include.

assets/js

assets/js directory is reserved and should only contain JavaScript files. To be used by the widget, specify these files in the *manifest.json*.

For example:

```
"assets": {
  "js": ["class.widget.js"]
}
```

assets/css

assets/css is reserved and should only contain CSS style files. To be used by the widget, specify these files in the *manifest.json*.

For example:

```
"assets": {
  "css": ["mywidget.css"]
}
```

CSS styles

CSS files may contain a custom attribute `theme` to define different style for a specific frontend themes.

Available themes and their attribute values:

- **Blue** - [theme='blue-theme']
- **Dark** - [theme='dark-theme']
- **High-contrast light** - [theme='hc-light']
- **High-contrast dark** - [theme='hc-dark']

Example:

```
.widget {
  background-color: red;
}

[theme='dark-theme'] .widget {
  background-color: green;
}
```

Register a new module

This section explains how to add a new module to Zabbix frontend.

Pre-requisites Before proceeding make sure, that:

- The module is located inside the *modules* directory of your Zabbix frontend installation (for example, *zabbix/ui/modules*).
- The module has at least a basic version of *manifest.json* file.
- You have access to the Administration menu section in Zabbix (requires Super admin user role type).

Note:

The frontend will not install or even recognize incompatible modules.

Adding a module Open *Administration*→*General*→*Modules* page and press *Scan directory*.

Scan directory

Locate your module in the list and activate it.

To activate a module, press on the *Disabled* hyperlink - the module's state will change to *Enabled*.

Press on the module name to view additional information about the module, such as author, version, or short description (if defined in the manifest).

Widget preview Widget modules, once added, become immediately visible in the dashboard widget list.

You can open a dashboard, switch to the edit mode and add the widget to the dashboard as usual.

When you make some changes to the widget, refresh the dashboard to view how the widget looks with the most recent updates.

Widgets

Widgets are Zabbix frontend modules used for the dashboards. Unless otherwise noted, all module guidelines are also applicable to widgets.

However, a widget is notably different from a module. To build a widget:

- specify the type "widget" in the `manifest.json` file ("type": "widget");
- include at least two views: one for the **widget presentation mode** and one for the **widget configuration mode** (example.widget.view.php and example.widget.edit.php);
- and a **controller** for widget presentation (WidgetView.php);
- use and extend default **widget classes**.

Configuration

This page describes classes that can be used to create a widget configuration view with custom configuration fields. The widget configuration view is the part of the widget that allows the user to configure widget parameters for **presentation**.

Widget

Primary widget class, extends the base class of all dashboard widgets - *CWidget*. Required for overriding the default widget behavior.

The *Widget* class should be located in the root directory of the widget (for example, *zabbix/ui/modules/my_custom_widget*).

Widget.php example

```
<?php

namespace Modules\MyCustomWidget;

use Zabbix\Core\CWidget;

class Widget extends CWidget {

    public const MY_CONSTANT = 0;

    public function getTranslationStrings(): array {
        return [
            'class.widget.js' => [
                'No data' => _('No data')
            ]
        ];
    }
}
```

WidgetForm

The *WidgetForm* class extends the default class *CWidgetForm* and contains a set of *CWidgetField* fields that are required for defining widget configuration storage structure in the database and handling input validation.

The *WidgetForm* class should be located in the *includes* directory. If the class has a different name, the name should be specified in the *widget/form_class* parameter in the *manifest.json* file.

includes/WidgetForm.php example

```
<?php

namespace Modules\MyCustomWidget\Includes;

use Modules\MyCustomWidget\Widget;
```

```

use Zabbix\Widgets\{
    CWidgetField,
    CWidgetForm
};

use Zabbix\Widgets\Fields\{
    CWidgetFieldMultiSelectItem,
    CWidgetFieldTextBox,
    CWidgetFieldColor
};

class WidgetForm extends CWidgetForm {

    public const DEFAULT_COLOR_PALETTE = [
        'FF465C', 'BOAF07', '0EC9AC', '524BBC', 'ED1248', 'D1E754', '2AB5FF', '385CC7', 'EC1594', 'BAE37D',
        '6AC8FF', 'EE2B29', '3CA20D', '6F4BBC', '00A1FF', 'F3601B', '1CAE59', '45CFDB', '894BBC', '6D6D6D'
    ];

    public function addFields(): self {
        return $this
            ->addField(
                (new CWidgetFieldMultiSelectItem('itemid', _('Item')))
                    ->setFlags(CWidgetField::FLAG_NOT_EMPTY | CWidgetField::FLAG_LABEL_ASTERISK)
                    ->setMultiple(false)
            )
            ->addField(
                new CWidgetFieldTextBox('description', _('Description'))
            )
            ->addField(
                (new CWidgetFieldColor('chart_color', _('Color')))->setDefault('FF0000')
            );
    }
}

```

CWidgetFormView

The *CWidgetFormView* class is required for specifying the presentation logic of the fields defined in the *WidgetForm* class, determining their appearance and behavior when rendered in the configuration view.

The *CWidgetFormView* class supports the following methods:

- *addField()* - receives an instance of the *CWidgetFieldView* class as a parameter; each *CWidgetField* class, has a respective *CWidgetFieldView* class for using in the widget configuration view.
- *addFieldset()* - receives an instance of the *CWidgetFieldsGroupView* class that combines fields into a collapsible container.
- *addFieldsGroup()* - receives an instance of *CWidgetFormFieldsetCollapsibleView* that visually (with a border) combines fields into a group.
- *includeJsFile()* - allows to add a JavaScript file to the widget configuration view.
- *addJavaScript()* - allows to add inline JavaScript that will be executed as soon as the widget configuration view is loaded.

The *CWidgetFormView* class should be located in the *views* directory.

views/widget.edit.php example

```

<?php

/**
 * My custom widget form view.
 *
 * @var CView $this
 * @var array $data
 */

use Modules\MyCustomWidget\Includes\WidgetForm;

```

```

(new CWidgetFormView($data))
  ->addField(
    (new CWidgetFieldMultiSelectItemView($data['fields']['itemid']))->setPopupParameter('numeric', true)
  )
  ->addFieldset(
    (new CWidgetFormFieldsetCollapsibleView(_('Advanced configuration')))
      ->addField(
        new CWidgetFieldTextView($data['fields']['description'])
      )
      ->addField(
        new CWidgetFieldColorView($data['fields']['chart_color'])
      )
    )
  ->includeJsFile('widget.edit.js.php')
  ->addJavaScript('my_custom_widget_form.init('.json_encode([
    'color_palette' => WidgetForm::DEFAULT_COLOR_PALETTE
  ]).'');')
  ->show();

```

JavaScript

A JavaScript class can be used to add dynamic behavior and interactivity to the widget configuration view. For example, you can initialize a color picker, defined in the *CWidgetFormView* class.

The JavaScript class should be loaded with the form, therefore it should be referenced in the *CWidgetFormView* class by using the methods *includeJsFile()* and *addJavaScript()*.

In the example below, a singleton class instance is immediately created and stored under the *window.my_custom_widget_form* name. Thus, opening the form for the second time will re-create the instance.

The JavaScript class should be located in the *views* directory.

views/widget.edit.js.php example

```

<?php
use Modules\MyCustomWidget\Widget;

?>

window.my_custom_widget_form = new class {
    init({color_palette}) {
        colorPalette.setThemeColors(color_palette);

        for (const colorpicker of jQuery('<? ZBX_STYLE_COLOR_PICKER ?> input')) {
            jQuery(colorpicker).colorpicker();
        }

        const overlay = overlays_stack.getById('widget_properties');

        for (const event of ['overlay.reload', 'overlay.close']) {
            overlay.$dialogue[0].addEventListener(event, () => { jQuery.colorpicker('hide'); });
        }
    }
};

```

CWidgetField

The *CWidgetField* class is a base class from which all form field classes (*CWidgetFieldCheckBox*, *CWidgetFieldTextArea*, *CWidgetFieldRadioButtonList*, etc.) are inherited. Classes extending *CWidgetField* are responsible for receiving, saving, and validating widget configuration values.

The following *CWidgetField* classes are available.

CWidgetField class	Database field type	Description
<i>CWidgetFieldCheckBox</i>	int32	Single checkbox.
<i>CWidgetFieldCheckBoxList</i>	array of int32	Multiple checkboxes under a single configuration field.
<i>CWidgetFieldColor</i>	string	Color selection field.
<i>CWidgetFieldDatePicker</i>	string	Date selection field.
<i>CWidgetFieldHostPatternSelect</i>	string	Multiselect field that allows to select one or multiple hosts. Supports defining host name patterns (all matching hosts will be selected).
<i>CWidgetFieldIntegerBox</i>	int32	Field to enter an integer. Can be used to configure minimum and maximum values.
<i>CWidgetFieldLatLng</i>	string	Text box that allows to enter comma-separated latitude, longitude, and map zoom level.
<i>CWidgetFieldMultiSelectActionID</i>	ID	Multiselect field for selecting actions (from the list of actions defined in the <i>Alerts</i> → <i>Actions</i>).
<i>CWidgetFieldMultiSelectGraphID</i>	ID	Multiselect field for selecting custom graphs.
<i>CWidgetFieldMultiSelectGraphIDPrototype</i>	ID	Multiselect field for selecting custom graph prototypes.
<i>CWidgetFieldMultiSelectGroupID</i>	ID	Multiselect field for selecting host groups.
<i>CWidgetFieldMultiSelectHostID</i>	ID	Multiselect field for selecting hosts.
<i>CWidgetFieldMultiSelectItemID</i>	ID	Multiselect field for selecting items.
<i>CWidgetFieldMultiSelectItemPattern</i>	Pattern	Multiselect field for selecting item patterns.
<i>CWidgetFieldMultiSelectItemIDPrototype</i>	ID	Multiselect field for selecting item prototypes.
<i>CWidgetFieldMultiSelectMapID</i>	ID	Multiselect field for selecting maps.
<i>CWidgetFieldMultiSelectMediaType</i>	MediaType	Multiselect field for selecting media types.
<i>CWidgetFieldMultiSelectOverViewHost</i>	Host	Multiselect field for selecting a data source (dashboard or other widget) containing a host for which the widget can display data.
<i>CWidgetFieldMultiSelectServiceID</i>	ID	Multiselect field for selecting services.
<i>CWidgetFieldMultiSelectSLAID</i>	ID	Multiselect field for selecting SLAs.
<i>CWidgetFieldMultiSelectUserID</i>	ID	Multiselect field for selecting users.
<i>CWidgetFieldNumericBox</i>	string	Field to enter a float number.
<i>CWidgetFieldRadioButtonList</i>	int32	Radio box group that consists of one or more radio boxes.
<i>CWidgetFieldRangeControl</i>	int32	Slider to select an integer type value.
<i>CWidgetFieldReference</i>	string	Creates a unique identifier for this widget on dashboard. It is used to reference this widget from other widgets.
<i>CWidgetFieldSelect</i>	int32	Dropdown select box.
<i>CWidgetFieldSeverities</i>	array of int32	<i>CWidgetFieldCheckBoxList</i> preset with trigger severities.
<i>CWidgetFieldTags</i>	array of (string, int32, string)	Allows to configure one or more tag filter rows.
<i>CWidgetFieldTextArea</i>	string	Text area for entering multi-line text.
<i>CWidgetFieldTextBox</i>	string	Text box for entering single-line text.
<i>CWidgetFieldTimePeriod</i>	array of string	Time period selecting field.
<i>CWidgetFieldTimeZone</i>	string	Dropdown with timezones.
<i>CWidgetFieldThresholds</i>	array of (string, string)	Allows configuring color and number pairs.
<i>CWidgetFieldUrl</i>	string	Text box that allows to enter URLs.

The following *CWidgetField* classes have been created for particular widgets. These classes have very specific use cases, but they can also be reused if needed.

CWidgetField class	Database field type	Description
<i>CWidgetFieldColumnsList</i>	array of (multiple mixed)	For <i>Top hosts</i> widget. Create a table with custom columns of allowed types.
<i>CWidgetFieldNavTree</i>	string	For <i>Map navigation tree</i> widget. Replaces widget view in edit mode with the map selection tree.

Presentation

This page describes the components that can be used to create a widget presentation view. The widget presentation view is the part of the widget that receives the data according to its **configuration** and displays it on the dashboard in a container.

The presentation view consists of three parts:

- **Widget action**

- [Widget view](#)
- [JavaScript](#)

Widget action

The widget action class (*WidgetView*) contains methods for operations with widgets in the presentation view mode. The majority of widget actions use and/or extend the default controller class *CControllerDashboardWidgetView*.

The widget action class should be located in the *actions* directory and specified in the *actions* parameter (*actions/widget.{id}.view/class*) in the *manifest.json* file.

actions/WidgetView.php example (implemented in the Zabbix-native **System information** widget)

```
class WidgetView extends CControllerDashboardWidgetView {

    protected function doAction(): void {
        $this->setResponse(new CControllerResponseData([
            'name' => $this->getInput('name', $this->widget->getDefaultName()),
            'system_info' => CSystemInfoHelper::getData(),
            'info_type' => $this->fields_values['info_type'],
            'user_type' => CWebUser::getType(),
            'user' => [
                'debug_mode' => $this->getDebugMode()
            ]
        ]));
    }
}
```

Widget view

The widget view class (*CWidgetView*) is responsible for building the widget presentation view.

The widget view class should be located in the *views* directory. If the file containing the widget view class has a different name than the default (*widget.view.php*), then it must be specified in the *manifest.json* file *actions* parameter (*actions/widget.{id}.view/view*).

views/widget.view.php example

```
<?php

/**
 * My custom widget view.
 *
 * @var CView $this
 * @var array $data
 */

(new CWidgetView($data))
    ->addItem(
        new CTag('h1', true, $data['name'])
    )
    ->show();
```

JavaScript

The JavaScript class is responsible for determining widget behavior, such as updating widget data, resizing the widget, displaying widget elements, etc.

All JavaScript operations use and/or extend the base JavaScript class of all dashboard widgets - *CWidget*. The *CWidget* class contains a set of methods with the default implementation for widget behavior. Depending on widget complexity, these methods can be utilized as is or extended.

The *CWidget* class contains the following methods:

- Methods that define widget lifecycle: *onInitialize()*, *onStart()*, *onActivate()*, *onDeactivate()*, *onDestroy()*, *onEdit()*.
- Methods that handle updating and displaying widget data: *promiseUpdate()*, *getUpdateRequestData()*, *processUpdateResponse(response)*, *processUpdateErrorResponse(error)*, *setContents(response)*.
- Methods that modify widget appearance: *onResize()*, *hasPadding()*.

The JavaScript class should be located in the *assets/js* directory and specified in the *assets* (*assets/js*) parameter in the *manifest.json* file.

Lifecycle methods

The widget lifecycle methods are invoked by the dashboard, and at different stages of the widget's lifecycle during its existence within the dashboard.

The ***onInitialize()*** method defines the initial state and/or values of the widget, without performing any HTML or data manipulation. This method is invoked when a widget is created (a widget object is instantiated), typically by adding the widget to a dashboard page or loading the dashboard page.

Example:

```
onInitialize() {
    this._time_offset = 0;
    this._interval_id = null;
    this._clock_type = CWidgetClock.TYPE_ANALOG;
    this._time_zone = null;
    this._show_seconds = true;
    this._time_format = 0;
    this._tzone_format = 0;
    this._show = [];
    this._has_contents = false;
    this._is_enabled = true;
}
```

The ***onStart()*** method defines the HTML structure of the widget, without performing any data manipulation. This method is invoked before the first activation of the dashboard page, that is, before the dashboard and its widgets are fully displayed to the user.

Example:

```
onStart() {
    this._events.resize = () => {
        const padding = 25;
        const header_height = this._view_mode === ZBX_WIDGET_VIEW_MODE_HIDDEN_HEADER
            ? 0
            : this._header.offsetHeight;

        this._target.style.setProperty(
            '--content-height',
            `${this._cell_height * this._pos.height - padding * 2 - header_height}px`
        );
    }
}
```

The ***onActivate()*** method makes the widget active and interactive by enabling custom event listeners (for responding to user actions) and initiating the widget update cycle (for keeping its content up-to-date). This method is invoked when the dashboard page is activated, that is, when it becomes fully displayed in the user interface.

Note that before the *onActivate()* method is invoked, the widget is in the inactive state (WIDGET_STATE_INACTIVE). After successful invocation, the widget transitions to the active state (WIDGET_STATE_ACTIVE). In the active state, the widget is responsive, listens to events, updates its content periodically, and can interact with other widgets.

Example:

```
onActivate() {
    this._startClock();

    this._resize_observer = new ResizeObserver(this._events.resize);
    this._resize_observer.observe(this._target);
}
```

The ***onDeactivate()*** method stops any activity and interactivity of the widget by deactivating custom event listeners and stopping the widget update cycle. This method is invoked when the dashboard page is deactivated, that is, switched away or deleted, or when the widget is deleted from the dashboard page.

Note that before the *onDeactivate()* method is invoked, the widget is in the active state (WIDGET_STATE_ACTIVE). After successful invocation, the widget transitions to the inactive state (WIDGET_STATE_INACTIVE).

Example:

```

onDeactivate() {
    this._stopClock();
    this._resize_observer.disconnect();
}

```

The **onDestroy()** method performs cleanup tasks before the widget is deleted from the dashboard, which can include closing a database connection that was established during widget initialization, cleaning up temporary data to free up system memory and avoid resource leaks, unregistering event listeners related to resize events or button clicks to prevent unnecessary event handling and memory leaks, etc. This method is invoked when the widget or the dashboard page that contains it is deleted.

Note that before the *onDestroy()* method is invoked, a widget in an active state (WIDGET_STATE_ACTIVE) is always deactivated with the invocation of the *onDeactivate()* method.

Example:

```

onDestroy() {
    if (this._filter_widget) {
        this._filter_widget.off(CWidgetMap.WIDGET_NAVTREE_EVENT_MARK, this._events.mark);
        this._filter_widget.off(CWidgetMap.WIDGET_NAVTREE_EVENT_SELECT, this._events.select);
    }
}

```

The **onEdit()** method defines the appearance and behavior of the widget when the dashboard transitions into editing mode. This method is invoked when the dashboard transitions into editing mode, typically when a user interacts with the widget's *Edit* button or the dashboard's *Edit dashboard* button.

Example:

```

onEdit() {
    this._deactivateGraph();
}

```

Update process methods

The widget update process methods are responsible for retrieving updated data from Zabbix server or any other data source and displaying it in the widget.

The **promiseUpdate()** method initiates the data update process by retrieving data, typically using web requests or API calls. This method is invoked when a dashboard page is displayed and periodically after, until the dashboard page is switched to another dashboard page.

The following is an example of the default implementation of the *promiseUpdate()* method used by most Zabbix-native widgets. In the default implementation, the *promiseUpdate()* method follows a general pattern for retrieving data from the server. It creates a new *Curl* object with the appropriate URL and request parameters, sends a POST request using the *fetch()* method with the data object constructed by the *getUpdateRequestData()* method, and processes the response (or an error response) with the *processUpdateResponse(response)* or *processUpdateErrorResponse(error)* accordingly. This implementation is suitable for most widgets as they typically retrieve data in a JSON format and handle it in a consistent manner.

```

promiseUpdate() {
    const curl = new Curl('zabbix.php');

    curl.setArgument('action', `widget.${this._type}.view`);

    return fetch(curl.getUrl(), {
        method: 'POST',
        headers: {'Content-Type': 'application/json'},
        body: JSON.stringify(this.getUpdateRequestData()),
        signal: this._update_abort_controller.signal
    })
    .then((response) => response.json())
    .then((response) => {
        if ('error' in response) {
            this.processUpdateErrorResponse(response.error);
        }

        return;
    })

    this.processUpdateResponse(response);
}

```



```
});
}
```

The **getUpdateRequestData()** method prepares the server request data for updating the widget by gathering various properties and their corresponding values (widget identifiers, filter settings, time ranges, etc.) from the widget's state and configuration, and constructing a data object that represents the necessary information to be sent to the server in the update request. This method is invoked only as part of the default *promiseUpdate()* method, that is, during the widget update process.

Default implementation:

```
getUpdateRequestData() {
  return {
    templateid: this._dashboard.templateid ?? undefined,
    dashboardid: this._dashboard.dashboardid ?? undefined,
    widgetid: this._widgetid ?? undefined,
    name: this._name !== '' ? this._name : undefined,
    fields: Object.keys(this._fields).length > 0 ? this._fields : undefined,
    view_mode: this._view_mode,
    edit_mode: this._is_edit_mode ? 1 : 0,
    dynamic_hostid: this._dashboard.templateid !== null || this.supportsDynamicHosts()
      ? (this._dynamic_hostid ?? undefined)
      : undefined,
    ...this._contents_size
  };
}
```

The **processUpdateResponse(response)** method handles the response received from the server after the update request, and, if the update process has been successful and without errors, clears widget data and displays new contents with the *setContents()* method. This method is invoked only as part of the default *promiseUpdate()* method, that is, during the widget update process.

Default implementation:

```
processUpdateResponse(response) {
  this._setHeaderName(response.name);

  this._updateMessages(response.messages);
  this._updateInfo(response.info);
  this._updateDebug(response.debug);

  this.setContents(response);
}
```

The **processUpdateErrorResponse(error)** method handles the response received from the server after the update request if the response is an error, and displays the error message/s. This method is invoked only as part of the default *promiseUpdate()* method, that is, during the widget update process.

Default implementation:

```
processUpdateErrorResponse(error) {
  this._updateMessages(error.messages, error.title);
}
```

The **setContents(response)** method displays widget contents if the widget update process has been successful and without errors, which can include manipulating DOM elements, updating UI components, applying styles or formatting, etc. This method is invoked only as part of the default *processUpdateResponse(response)* method, that is, during the process of handling the response received from the server after the update request.

Default implementation:

```
setContents(response) {
  this._body.innerHTML = response.body ?? '';
}
```

Presentation modification methods

The widget presentation modification methods are responsible for modifying widget appearance.

The **onResize()** method is responsible for adjusting widget's visual elements to accommodate the new widget size, which can include rearranging elements, adjusting element dimensions, text truncation, implementing lazy loading to improve responsiveness

during resizing, etc. This method is invoked when the widget is resized, for example, when the user manually resizes the widget or when the browser window is resized.

Example:

```
onResize() {
    if (this.getState() === WIDGET_STATE_ACTIVE) {
        this._startUpdating();
    }
}
```

The ***hasPadding()*** method is responsible for applying an 8px vertical padding at the bottom of the widget when it is configured to **show its header**. This method is invoked when the dashboard page is activated, that is, when it becomes the displayed page in the user interface.

Default implementation:

```
hasPadding() {
    return this.getViewMode() !== ZBX_WIDGET_VIEW_MODE_HIDDEN_HEADER;
}
```

For some widgets it is necessary to use all of the available widget space to configure, for example, a custom background color. The following is an example of the implementation of the *hasPadding()* method used in the Zabbix-native *Item value* widget.

```
hasPadding() {
    return false;
}
```

Tutorials

This section contains practical step-by-step tutorials to illustrate how to build a custom **module** and a **widget** in Zabbix.

Create a module (tutorial)

This is a step-by-step tutorial that shows how to create a simple Zabbix frontend module. You can download all files of this module as a ZIP archive: [MyAddress.zip](#).

What you'll build

During this tutorial, you will first build a frontend module that adds a new *My Address* menu section and then convert it into a **more advanced** frontend module that makes an HTTP request to <https://api.seeip.org> and displays the response - the IP address of your computer - on a new page in the newly created *My Address* menu section. Here's how the finished module will look like:

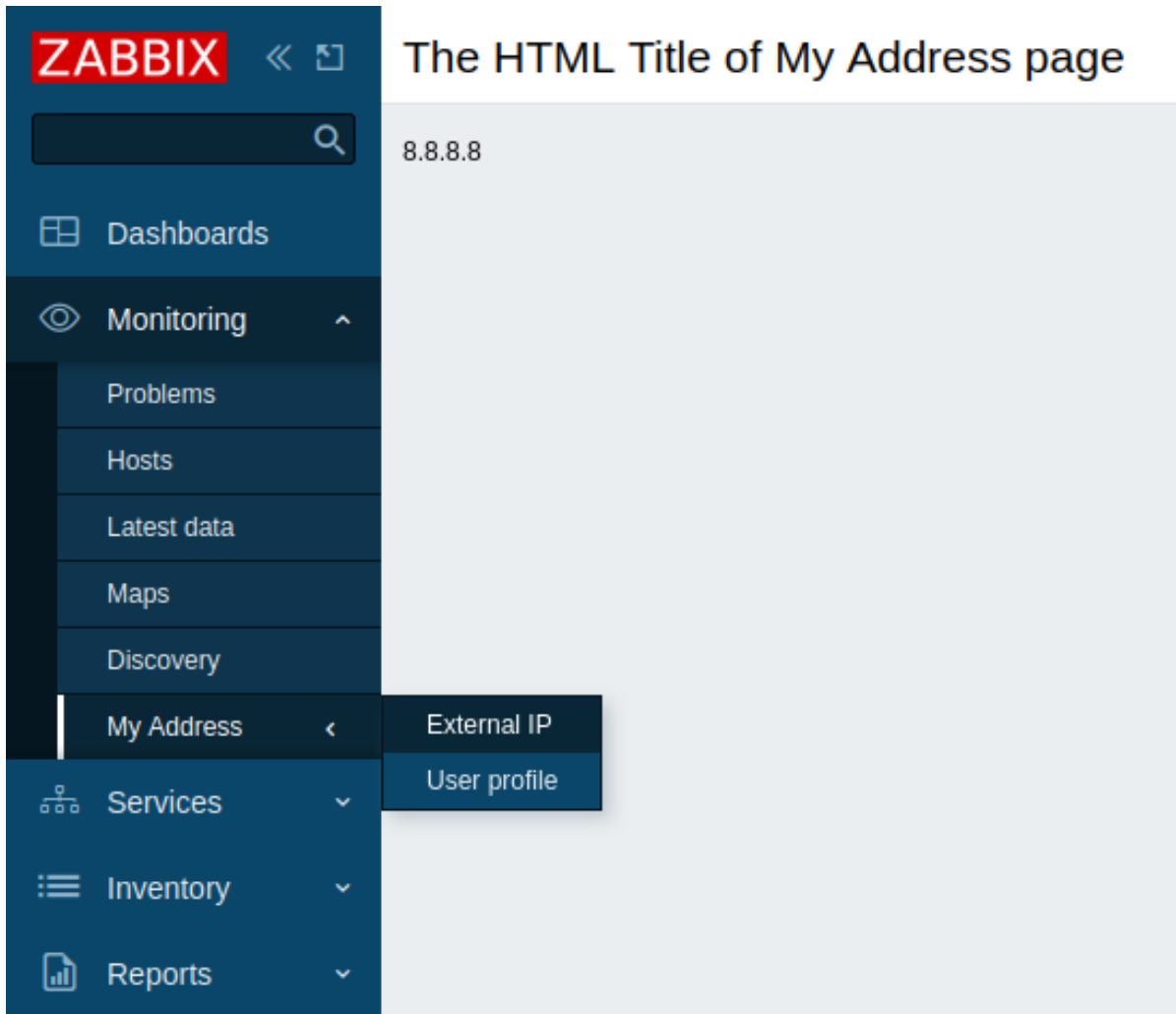

Part I - New menu section

Add a blank module to Zabbix frontend

1. Create a directory *MyAddress* in the *modules* directory of your Zabbix frontend installation (for example, *zabbix/ui/modules*).
2. Create a *manifest.json* file with basic module metadata (see the description of supported [parameters](#)).

ui/modules/MyAddress/manifest.json

```
{
  "manifest_version": 2.0,
  "id": "my-address",
  "name": "My IP Address",
  "version": "1.0",
  "namespace": "MyAddress",
  "description": "My External IP Address."
}
```

3. In Zabbix frontend, go to *Administration* → *General* → *Modules* section and click on the *Scan directory* button.

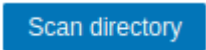

4. Locate the new module *My IP Address* in the list and click on the "Disabled" hyperlink to change the module's status from "Disabled" to "Enabled".

Module Name	Version	Description	Status
Map	1.0	Zabbix Displays either a single configured network map or one of the configured network maps in the map navigation tree.	Enabled
Map navigation tree	1.0	Zabbix Allows to build a hierarchy of existing maps and display problem statistics for each included map and map group.	Enabled
My IP Address	1.0	My External IP Address.	Disabled
Plain text	1.0	Zabbix Displays the latest data for the selected items in plain text.	Enabled
Problem hosts	1.0	Zabbix Displays the problem count by host group and the highest problem severity within a group.	Enabled

The module is now registered in the frontend. However, it is not visible yet, because you still need to define the module functionality. Once you add content to the module directory, you will immediately see the changes in Zabbix frontend upon refreshing the page.

Create a menu section

1. Create a *Module.php* file in the *MyAddress* directory.

This file implements a new *Module* class that extends the default *CModule* class. The *Module* class will insert a new *My Address* menu section into the main menu.

The *setAction()* method specifies an action to be executed upon clicking on the menu section. To start with, you can use the predefined action *userprofile.edit*, which will open the *User profile* page. In **part III** of this tutorial, you will learn how to create a custom action.

ui/modules/MyAddress/Module.php

```
<?php

namespace Modules\MyAddress;

use Zabbix\Core\CModule,
    APP,
    CMenuItem;

class Module extends CModule {

    public function init(): void {
        APP::Component()->get('menu.main')
            ->add((new CMenuItem_('My Address')))
            ->setAction('userprofile.edit');
    }
}
```

Note:

You can replace 'userprofile.edit' with other actions, for example, 'charts.view' (opens custom graphs), 'problems.view' (opens *Monitoring* → *Problems*), or 'report.status' (opens *System information* report).

3. Refresh Zabbix frontend. There is now a new *My Address* section at the bottom of the Zabbix main menu. Click on *My Address* to open the *User profile* page.

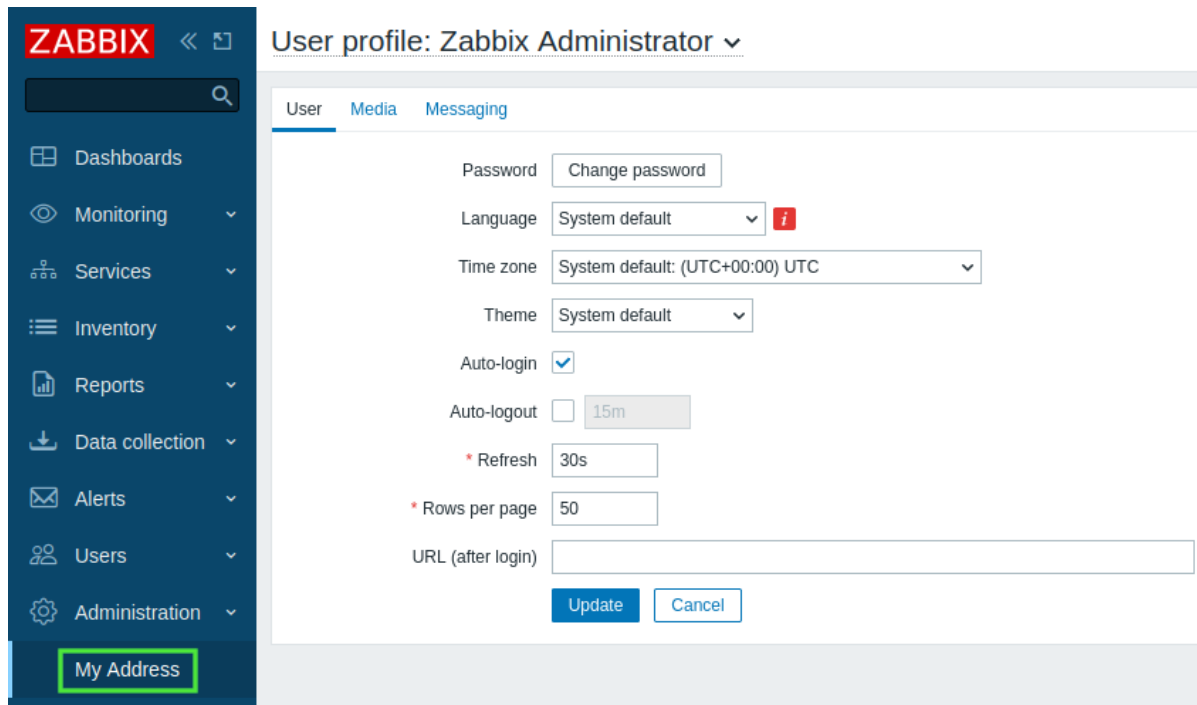

Part II - Menu section location change

In this part, you will move the *My Address* menu section to the *Monitoring* section and then add a nested menu to it. As a result, users will be able to access two sub-menu pages from the *Monitoring* → *My Address* menu section.

1. Open and edit the *Module.php* file.

ui/modules/MyAddress/Module.php

```

<?php

namespace Modules\MyAddress;

use Zabbix\Core\CModule,
    APP,
    CMenuItem;

class Module extends CModule {

    public function init(): void {
        APP::Component()->get('menu.main')
            ->findOrAdd_('Monitoring')
            ->getSubmenu()
            ->insertAfter_('Discovery'),
                (new CMenuItem_('My Address'))->setAction('userprofile.edit')
            );
    }
}

```

- Refresh Zabbix frontend. Expand the *Monitoring* menu section and observe that the *My address* section is now located below the *Discovery* section.

- To add nested pages to the *My Address* menu section, open and edit the *Module.php* file again.

This step creates two subsections:

- *External IP* that executes a new 'my.address' action that will be defined in the next steps;
- *User profile* that executes the predefined 'userprofile.edit' action to open the *User profile* page.

Note that for the nested menu, you need to use the *CMenu* class in addition to the classes used in the previous steps.

ui/modules/MyAddress/Module.php

```

<?php

namespace Modules\MyAddress;

use Zabbix\Core\CModule,
    APP,
    CMenu,
    CMenuItem;

class Module extends CModule {

```

```

public function init(): void {
    APP::Component()->get('menu.main')
        ->findOrAdd_('Monitoring')
        ->getSubmenu()
        ->insertAfter_('Discovery',
            (new CMenuItem_('My Address'))->setSubMenu(
                new CMenu([
                    (new CMenuItem_('External IP'))->setAction('my.address'),
                    (new CMenuItem_('User profile'))->setAction('userprofile.edit')
                ])
            )
        );
}
}

```

4. Refresh Zabbix frontend. Observe that the *My address* menu section now contains a third-level menu with two pages - *External IP* and *User profile*.

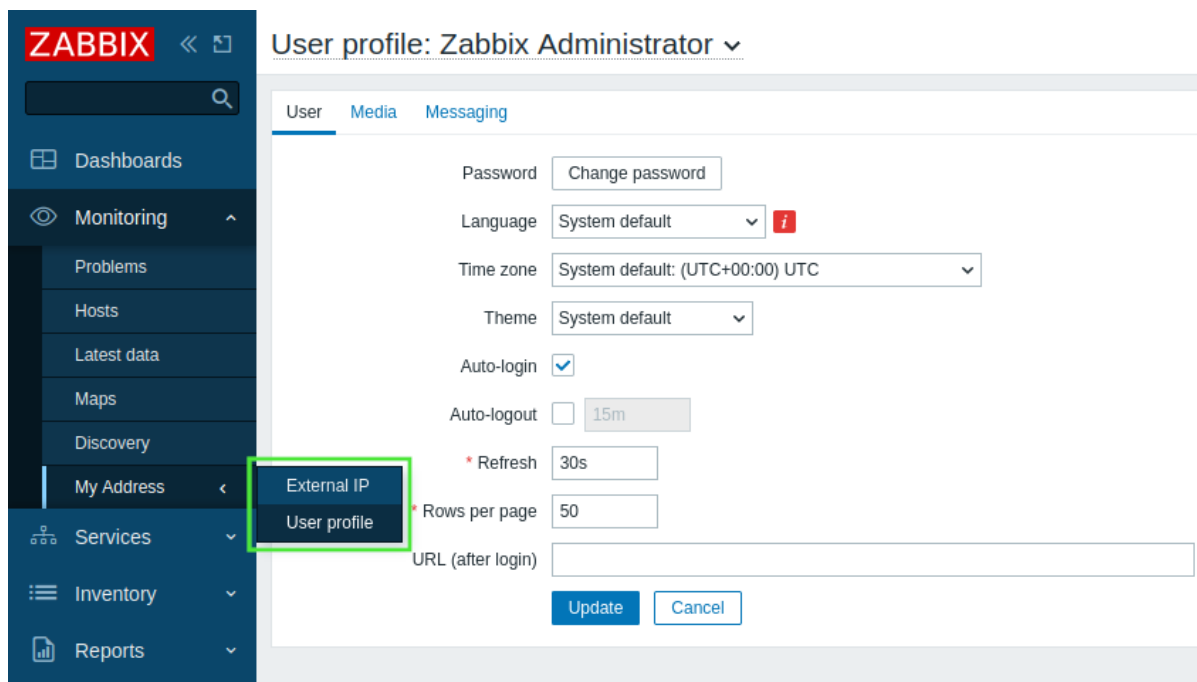

Part III - Module action

An action is implemented in two files - *actions/MyAddress.php* and *views/my.address.php*. The ***actions/MyAddress.php*** file takes care of the business logic implementation, while the ***views/my.address.php*** file is responsible for the view.

1. Create a directory *actions* in the *MyAddress* directory.
2. Create a *MyAddress.php* file in the *actions* directory.

The action logic will be defined in the *MyAddress* class. This action class will implement four functions: *init()*, *checkInput()*, *checkPermissions()*, and *doAction()*. Zabbix frontend calls the *doAction()* function when the action is requested. This function is responsible for the business logic of the module.

Attention:

The data must be organized as an associative array. The array can be multidimensional and may contain any data expected by the view.

ui/modules/MyAddress/actions/MyAddress.php

```

<?php

namespace Modules\MyAddress\Actions;

use CController,
    CControllerResponseData;

```

```

class MyAddress extends CController {

    public function init(): void {
        $this->disableCsrfValidation();
    }

    protected function checkInput(): bool {
        return true;
    }

    protected function checkPermissions(): bool {
        return true;
    }

    protected function doAction(): void {
        $data = ['my-ip' => file_get_contents("https://api.seeip.org")];
        $response = new CControllerResponseData($data);
        $this->setResponse($response);
    }
}

```

3. Create a new directory `views` in the `MyAddress` directory.
4. Create a `my.address.php` file in the `views` directory and define the module view.

Note that the variable `$data` is available in the view without specifically defining it. The framework automatically passes the associative array to the view.

ui/modules/MyAddress/views/my.address.php

```

<?php

(new CHtmlPage())
->setTitle(_('The HTML Title of My Address Page'))
->addItem(new CDiv($data['my-ip']))
->show();

```

5. The module action has to be registered in the `manifest.json` file. Open `manifest.json` and add a new object actions that contains:
 - the action key with the action name written in lowercase (a-z) and with words separated by dots (for example, `my.address`);
 - the action class name (`MyAddress`) as a value for the `class` key of the `my.address` object;
 - the action view name (`my.address`) as a value for the `view` key of the `my.address` object.

ui/modules/MyAddress/manifest.json

```

{
    "manifest_version": 2.0,
    "id": "my-address",
    "name": "My IP Address",
    "version": "1.0",
    "namespace": "MyAddress",
    "description": "My External IP Address.",
    "actions": {
        "my.address": {
            "class": "MyAddress",
            "view": "my.address"
        }
    }
}

```

6. Refresh Zabbix frontend. Click on `My address` → `External IP` to see the IP address of your computer.

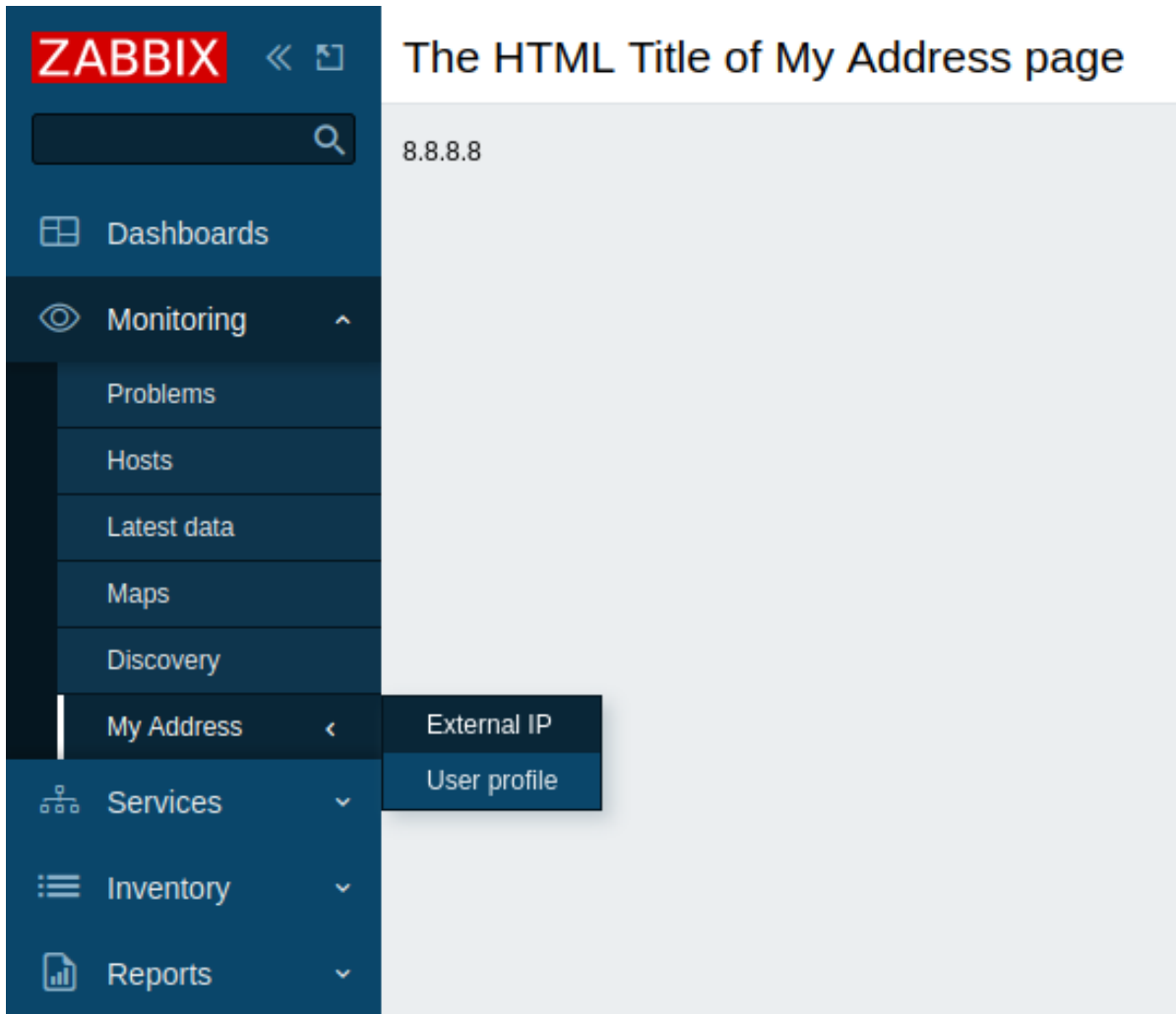

Create a widget (tutorial)

This is a step-by-step tutorial that shows how to create a simple dashboard widget. You can download all files of this widget as a ZIP archive: [lesson_gauge_chart.zip](#).

What you'll build During this tutorial, you will first build a **basic** "Hello, world!" widget and then convert it into a **more advanced** widget that displays an item value as a gauge chart. Here's how the finished widget will look like:

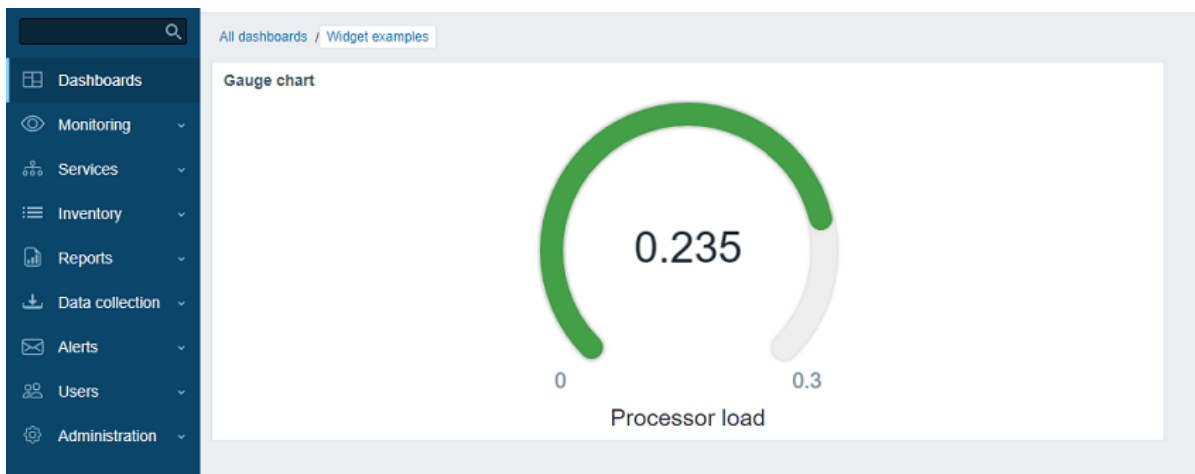

Part I - "Hello, world!" In this section you will learn how to create the minimum required widget elements and add a new widget to Zabbix frontend.

Add a blank widget to Zabbix frontend

1. Create a directory `lesson_gauge_chart` in the `modules` directory of your Zabbix frontend installation (for example, `zabbix/ui/modules`).

Note:

All custom widgets are treated as external modules and must be added to the `modules` directory of your Zabbix frontend installation (for example, `zabbix/ui/modules`). The directory `zabbix/ui/widgets` is reserved for Zabbix built-in widgets and gets updated along with Zabbix UI.

2. Create a `manifest.json` file with basic widget metadata (see the description of supported [parameters](#)).

ui/modules/lesson_gauge_chart/manifest.json

```
{
  "manifest_version": 2.0,
  "id": "lesson_gauge_chart",
  "type": "widget",
  "name": "Gauge chart",
  "namespace": "LessonGaugeChart",
  "version": "1.1",
  "author": "Zabbix"
}
```

3. In Zabbix frontend, go to *Administration* → *General* → *Modules* section and click on the *Scan directory* button.

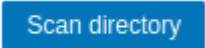

4. Locate the new module *Gauge chart* in the list and click on the "Disabled" hyperlink to change the module's status from "Disabled" to "Enabled".

<input type="checkbox"/>	Favorite graphs	1.0	Zabbix	Displays shortcuts to the most needed graphs (marked as favorite).	Enabled
<input type="checkbox"/>	Favorite maps	1.0	Zabbix	Displays shortcuts to the most needed network maps (marked as favorite).	Enabled
<input type="checkbox"/>	Gauge chart	1.0	Zabbix		Disabled
<input type="checkbox"/>	Geomap	1.0	Zabbix	Displays hosts as markers on a geographical map.	Enabled
<input type="checkbox"/>	Graph	1.0	Zabbix	Displays data of up to 50 items as line, points, staircase, or bar charts.	Enabled

5. Open a dashboard, switch it to the edit mode and add a new widget. In the *Type* field, select "Gauge chart".

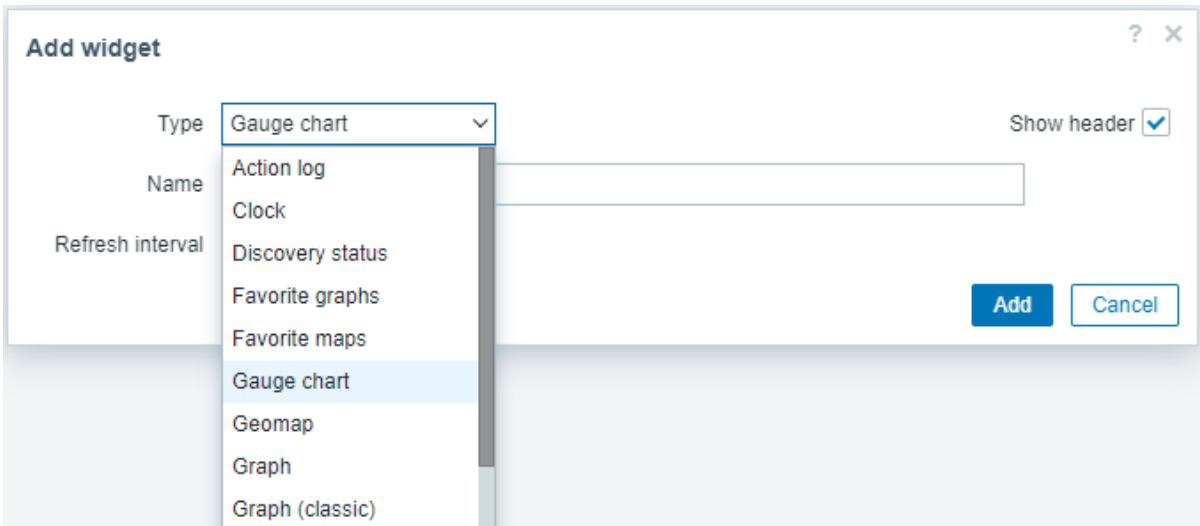

6. At this point, the *Gauge chart* widget configuration contains only common widget fields *Name* and *Refresh interval*. Click on *Add* to add the widget to the dashboard.

Add widget ? X

Type Gauge chart Show header

Name default

Refresh interval Default (1 minute)

Add
Cancel

7. A blank widget should appear on the dashboard. Click on *Save changes* in the top right corner to save the dashboard.

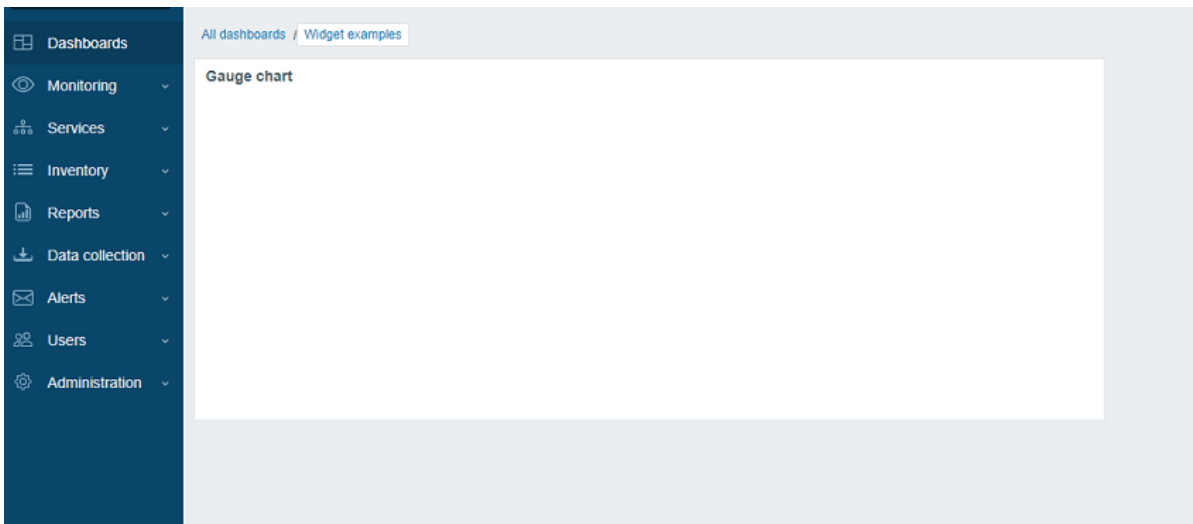

Add a widget view

Note:

The widget's **view** file should be located in the *views* directory (for this tutorial, *ui/modules/lesson_gauge_chart/views/*). If the file has the default name *widget.view.php*, you do not need to register it in the *manifest.json* file. If the file has a different name, specify it in the *actions/widget.lesson_gauge_chart.view* section of the *manifest.json* file.

1. Create a directory *views* in the *lesson_gauge_chart* directory.
2. Create a *widget.view.php* file in the *views* directory.

ui/modules/lesson_gauge_chart/views/widget.view.php

```
<?php

/**
 * Gauge chart widget view.
 *
 * @var CView $this
 * @var array $data
 */

(new CWidgetView($data))
    ->addItem(
        new CTag('h1', true, 'Hello, world!')
    )
    ->show();
```

3. Refresh the dashboard. The *Gauge chart* widget now displays "Hello, world!".

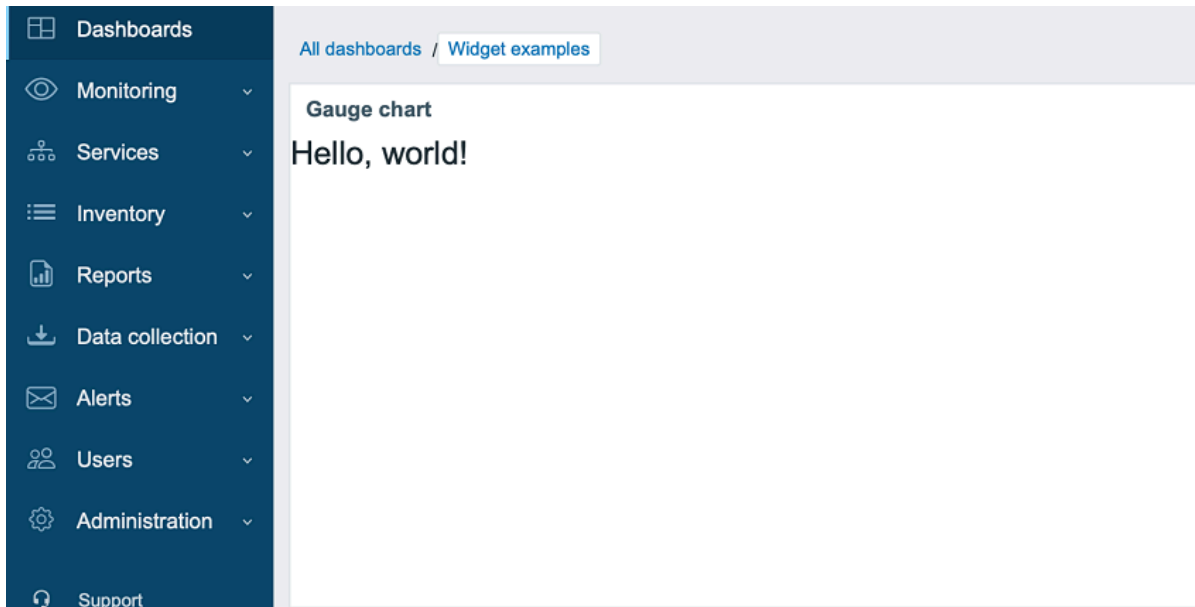

Part II - Gauge chart Add settings to a configuration view and use them in a widget view

In this section, you will learn how to add a widget configuration field and show the entered value in the widget view as text.

The widget configuration consists of a form (*Zabbix\Widgets\CWidgetForm*) and a widget form view (*widget.edit.php*). To add fields (*Zabbix\Widgets\CWidgetField*), you need to create a *WidgetForm* class, which will extend *Zabbix\Widgets\CWidgetForm*.

The form contains the set of fields (*Zabbix\Widgets\CWidgetField*) of various types, which are used to validate user-entered values. The form field (*Zabbix\Widgets\CWidgetField*) for each input element type converts the value into a single format to store it in the database.

Note:

The widget's **form** file should be located in the *includes* directory (for this tutorial, *ui/modules/lesson_gauge_chart/includes/*). If the file has the default name *WidgetForm.php*, you do not need to register it in the *manifest.json* file. If the file has a different name, specify it in the *widget/form_class* section of the *manifest.json* file.

1. Create a new directory *includes* in the *lesson_gauge_chart* directory.
2. Create a *WidgetForm.php* file in the *includes* directory.

ui/modules/lesson_gauge_chart/includes/WidgetForm.php

```
<?php
namespace Modules\LessonGaugeChart\Includes;
use Zabbix\Widgets\CWidgetForm;
class WidgetForm extends CWidgetForm {
}
```

3. Add a *Description* field to widget configuration form. This is a regular text field, where a user can enter any character set. You can use the *CWidgetFieldTextBox* class for it.

ui/modules/lesson_gauge_chart/includes/WidgetForm.php

```
<?php
namespace Modules\LessonGaugeChart\Includes;
use Zabbix\Widgets\CWidgetForm;
use Zabbix\Widgets\Fields\CWidgetFieldTextBox;
class WidgetForm extends CWidgetForm {
```

```

public function addFields(): self {
    return $this
        ->addField(
            new CWidgetFieldTextBox('description', _('Description'))
        );
}
}

```

- In the `views` directory, create a widget configuration view file `widget.edit.php` and add a view for the new `Description` field. For the `CWidgetFieldTextBox` field class, the view is `CWidgetFieldTextBoxView`.

ui/modules/lesson_gauge_chart/views/widget.edit.php

```

<?php

/**
 * Gauge chart widget form view.
 *
 * @var CView $this
 * @var array $data
 */

(new CWidgetFormView($data))
    ->addField(
        new CWidgetFieldTextBoxView($data['fields']['description'])
    )
    ->show();

```

- Go to the dashboard and click on the gear icon in the widget to open the widget configuration form.
- The widget configuration form now contains a new `Description` text field. Enter any value, for example, `Gauge chart description`.

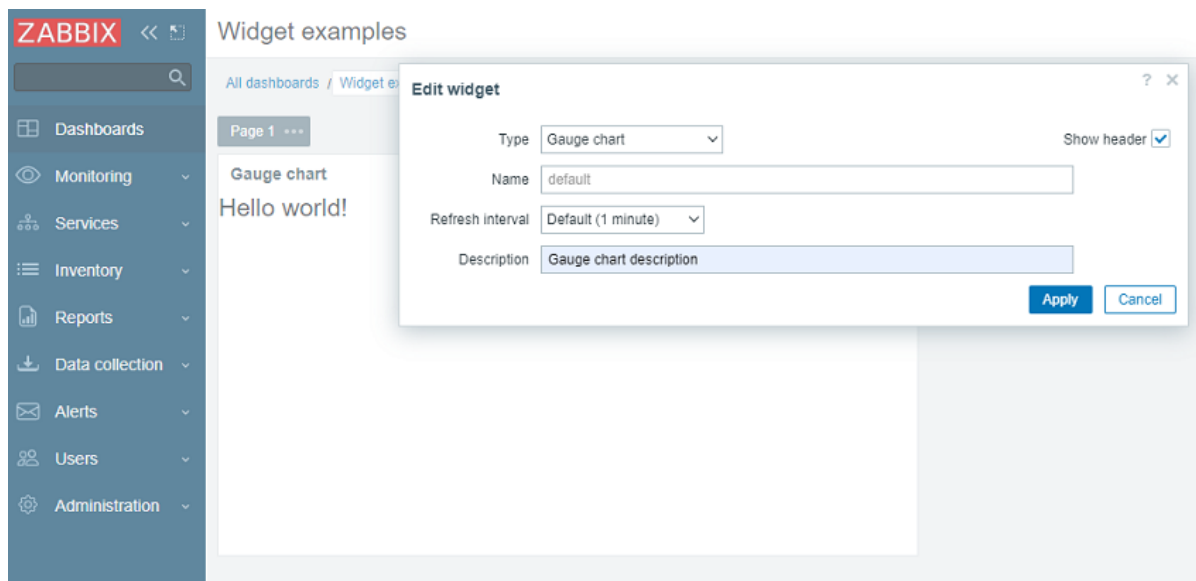

- Click on `Apply` in the widget configuration form. Then click on `Save changes` in the top right corner to save the dashboard. Note that the new description is not visible anywhere, and the widget still displays "Hello, world!".

For the new description to appear in the widget, the `Description` field value needs to be retrieved from the database and passed to the widget view. For that, you need to create an action class.

- Create a new directory `actions` in the `lesson_gauge_chart` directory.
- Create a `WidgetView.php` file in the `actions` directory. The `WidgetView` action class will extend the `CControllerDashboard-WidgetView` class.

Values of the widget configuration fields are stored in the `$fields_values` property of the action class.

ui/modules/lesson_gauge_chart/actions/WidgetView.php

```

<?php

namespace Modules\LessonGaugeChart\Actions;

use CControllerDashboardWidgetView,
    CControllerResponseData;

class WidgetView extends CControllerDashboardWidgetView {

    protected function doAction(): void {
        $this->setResponse(new CControllerResponseData([
            'name' => $this->getInput('name', $this->widget->getName()),
            'description' => $this->fields_values['description'],
            'user' => [
                'debug_mode' => $this->getDebugMode()
            ]
        ]));
    }
}

```

10. Open *manifest.json* and register *WidgetView* as an action class in the *actions/widget.lesson_gauge_chart.view* section.

ui/modules/lesson_gauge_chart/manifest.json

```

{
    "manifest_version": 2.0,
    "id": "lesson_gauge_chart",
    "type": "widget",
    "name": "Gauge chart",
    "namespace": "LessonGaugeChart",
    "version": "1.0",
    "author": "Zabbix",
    "actions": {
        "widget.lesson_gauge_chart.view": {
            "class": "WidgetView"
        }
    }
}

```

11. Now you can use the value of the description field, contained in *\$data['description']*, in the widget view. Open *views/widget.view.php* and replace the static text "Hello, world!" with *\$data['description']*.

ui/modules/lesson_gauge_chart/views/widget.view.php

```

<?php

/**
 * Gauge chart widget view.
 *
 * @var CView $this
 * @var array $data
 */

(new CWidgetView($data))
    ->addItem(
        new CTag('h1', true, $data['description'])
    )
->show();

```

12. Refresh the dashboard page. You should now see the widget description text instead of "Hello, world!".

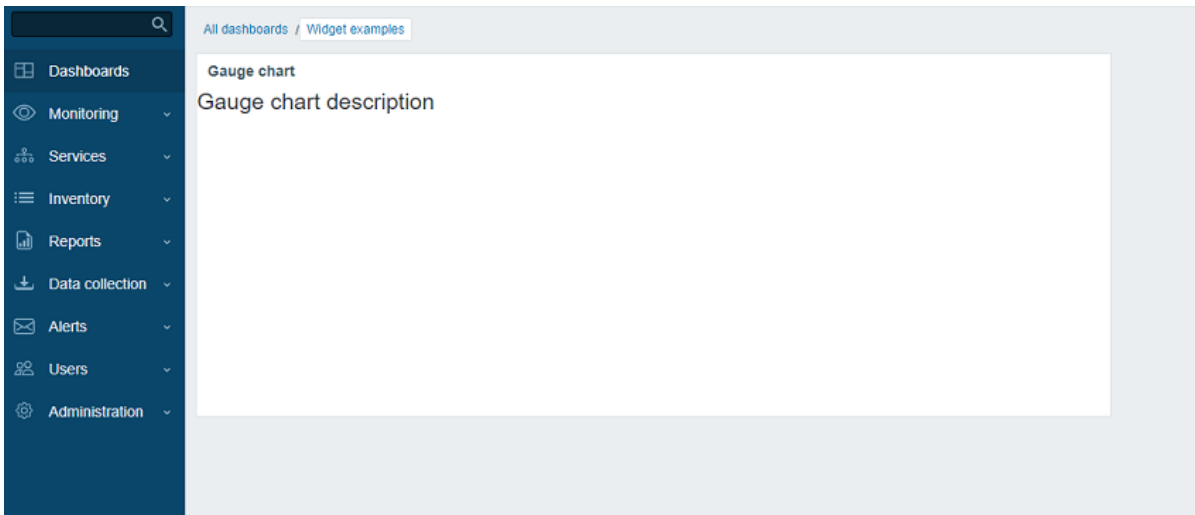

Retrieve an item value via API

The widget should show the last value of an item of user's choice. For that, you need to add the ability to select items in the widget configuration.

In this section, you will learn how to add an item selection field to the widget form and how to add the visual part of this field to the configuration view. Then, the widget controller will be able to retrieve item data and its value via an API request. Once received, the value can be displayed in the widget view.

1. Open `includes/WidgetForm.php` and add the `CWidgetFieldMultiSelectItem` field. This will allow selecting an item in the configuration form.

`ui/modules/lesson_gauge_chart/includes/WidgetForm.php`

```
<?php

namespace Modules\LessonGaugeChart\Includes;

use Zabbix\Widgets\{
    CWidgetField,
    CWidgetForm
};

use Zabbix\Widgets\Fields\{
    CWidgetFieldMultiSelectItem,
    CWidgetFieldTextBox
};

/**
 * Gauge chart widget form.
 */
class WidgetForm extends CWidgetForm {

    public function addFields(): self {
        return $this
            ->addField(
                (new CWidgetFieldMultiSelectItem('itemid', _('Item')))
                    ->setFlags(CWidgetField::FLAG_NOT_EMPTY | CWidgetField::FLAG_LABEL_ASTERISK)
                    ->setMultiple(false)
            )
            ->addField(
                new CWidgetFieldTextBox('description', _('Description'))
            );
    }
}
```

2. Open `views/widget.edit.php` and add the field visual component to the configuration view.

`ui/modules/lesson_gauge_chart/views/widget.edit.php`

```

<?php

/**
 * Gauge chart widget form view.
 *
 * @var CView $this
 * @var array $data
 */

(new CWidgetFormView($data))
    ->addField(
        new CWidgetFieldMultiSelectItemView($data['fields']['itemid'])
    )
    ->addField(
        new CWidgetFieldTextBoxView($data['fields']['description'])
    )
    ->show();

```

- Return to the dashboard and click on the gear icon in the widget to open the widget configuration form.
- The widget configuration form now contains a new input field *Item*. Select the host "Zabbix server" and the item "Load average (1m avg)".

The screenshot shows a modal window titled "Edit widget" with a close button (X) and a help button (?). The form contains the following fields:

- Type:** A dropdown menu set to "Gauge chart".
- Name:** A text input field containing "default".
- Refresh interval:** A dropdown menu set to "Default (1 minute)".
- * Item:** A text input field containing "Zabbix server: Load average (1m avg)" with a close button (X) on the right. A "Select" button is positioned to the right of this field.
- Description:** A text input field containing "Gauge chart description".

At the bottom right of the form, there are two buttons: "Apply" (highlighted in blue) and "Cancel". A "Show header" checkbox is checked in the top right corner.

- Click on *Apply* in the widget configuration form. Then click on *Save changes* in the top right corner to save the dashboard.
- Open and modify *actions/WidgetView.php*.

From now on, the item ID will be available in the widget controller in `$this->fields_values['itemid']`. The `doAction()` controller method collects the item data (name, value type, units) using the API method `item.get` and the item last value using the API method `history.get`.

ui/modules/lesson_gauge_chart/actions/WidgetView.php

```

<?php

namespace Modules\LessonGaugeChart\Actions;

use API,
    CControllerDashboardWidgetView,
    CControllerResponseData;

class WidgetView extends CControllerDashboardWidgetView {

    protected function doAction(): void {
        $db_items = API::Item()->get([
            'output' => ['itemid', 'value_type', 'name', 'units'],
            'itemids' => $this->fields_values['itemid'],
            'webitems' => true,
            'filter' => [
                'value_type' => [ITEM_VALUE_TYPE_UINT64, ITEM_VALUE_TYPE_FLOAT]
            ]
        ])
    }
}

```

```

    ]);

    $value = null;

    if ($db_items) {
        $item = $db_items[0];

        $history = API::History()->get([
            'output' => API_OUTPUT_EXTEND,
            'itemids' => $item['itemid'],
            'history' => $item['value_type'],
            'sortfield' => 'clock',
            'sortorder' => ZBX_SORT_DOWN,
            'limit' => 1
        ]);

        if ($history) {
            $value = convertUnitsRaw([
                'value' => $history[0]['value'],
                'units' => $item['units']
            ]);
        }
    }

    $this->setResponse(new CControllerResponseData([
        'name' => $this->getInput('name', $this->widget->getName()),
        'value' => $value,
        'description' => $this->fields_values['description'],
        'user' => [
            'debug_mode' => $this->getDebugMode()
        ]
    ]));
}
}
}

```

7. Open `views/widget.view.php` and add the item value to the widget view.

ui/modules/lesson_gauge_chart/views/widget.view.php

```

<?php

/**
 * Gauge chart widget view.
 *
 * @var CView $this
 * @var array $data
 */

(new CWidgetView($data))
    ->addItem([
        new CTag('h1', true, $data['description']),
        new CDiv($data['value'] !== null ? $data['value']['value'] : _('No data'))
    ])
    ->show();

```

8. Refresh the dashboard page. The widget will display the latest item value.

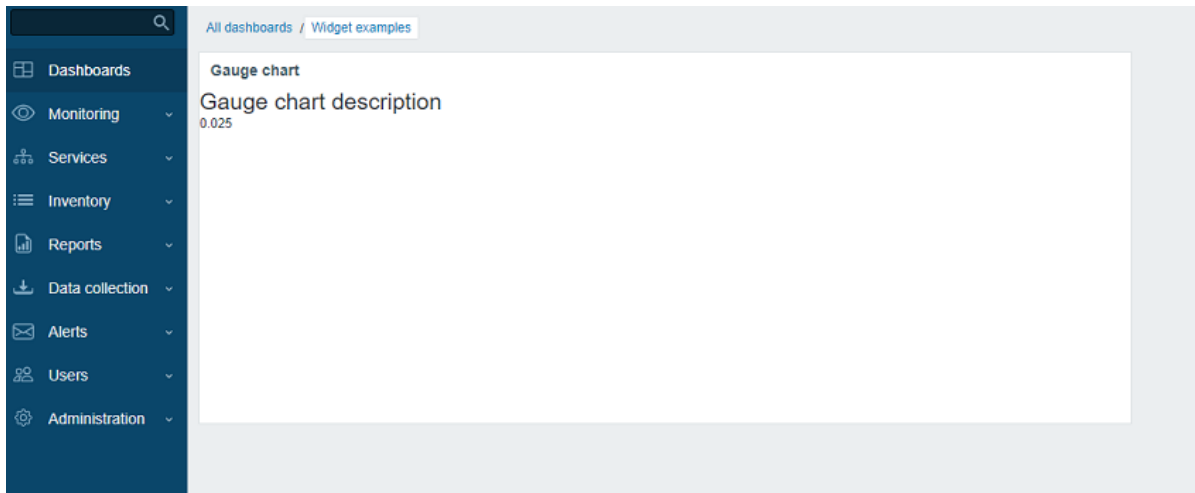

Add advanced configuration settings to a configuration view

In this section, you will learn how to add an expandable/collapsible *Advanced configuration* section with optional parameters, such as color, minimum and maximum values, units and the *Description* field created earlier.

1. Create a *Widget.php* file in the main widget directory *lesson_gauge_chart* to create a new class *Widget*.

The *Widget* class will extend the *CWidget* base class to add/override the default widget settings (in this case - translations). JavaScript, provided below, displays the string "No data" in case of missing data. The "No data" string is present in the Zabbix UI translation files.

If there are any widget constants, it is recommended to also specify them in the *Widget* class.

ui/modules/lesson_gauge_chart/Widget.php

```
<?php

namespace Modules\LessonGaugeChart;

use Zabbix\Core\CWidget;

class Widget extends CWidget {

    public const UNIT_AUTO = 0;
    public const UNIT_STATIC = 1;

    public function getTranslationStrings(): array {
        return [
            'class.widget.js' => [
                'No data' => _('No data')
            ]
        ];
    }
}
```

2. Open *includes/WidgetForm.php* and add the new fields *Color* (color picker), *Min* (numeric field), *Max* (numeric field), and *Units* (select), and define the default color palette for the color picker, so that it can be used in the next steps.

ui/modules/lesson_gauge_chart/includes/WidgetForm.php

```
<?php

namespace Modules\LessonGaugeChart\Includes;

use Modules\LessonGaugeChart\Widget;

use Zabbix\Widgets\{
    CWidgetField,
    CWidgetForm
};
```

```

use Zabbix\Widgets\Fields\{
    CWidgetFieldColor,
    CWidgetFieldMultiSelectItem,
    CWidgetFieldNumericBox,
    CWidgetFieldSelect,
    CWidgetFieldTextBox
};

/**
 * Gauge chart widget form.
 */
class WidgetForm extends CWidgetForm {

    public const DEFAULT_COLOR_PALETTE = [
        'FF465C', 'BOAF07', 'OEC9AC', '524BBC', 'ED1248', 'D1E754', '2AB5FF', '385CC7', 'EC1594', 'BAE37D',
        '6AC8FF', 'EE2B29', '3CA20D', '6F4BBC', '00A1FF', 'F3601B', '1CAE59', '45CFDB', '894BBC', '6D6D6D'
    ];

    public function addFields(): self {
        return $this
            ->addField(
                (new CWidgetFieldMultiSelectItem('itemid', _('Item')))
                    ->setFlags(CWidgetField::FLAG_NOT_EMPTY | CWidgetField::FLAG_LABEL_ASTERISK)
                    ->setMultiple(false)
            )
            ->addField(
                (new CWidgetFieldColor('chart_color', _('Color')))->setDefault('FF0000')
            )
            ->addField(
                (new CWidgetFieldNumericBox('value_min', _('Min')))
                    ->setDefault(0)
                    ->setFlags(CWidgetField::FLAG_NOT_EMPTY | CWidgetField::FLAG_LABEL_ASTERISK)
            )
            ->addField(
                (new CWidgetFieldNumericBox('value_max', _('Max')))
                    ->setDefault(100)
                    ->setFlags(CWidgetField::FLAG_NOT_EMPTY | CWidgetField::FLAG_LABEL_ASTERISK)
            )
            ->addField(
                (new CWidgetFieldSelect('value_units', _('Units'), [
                    Widget::UNIT_AUTO => _x('Auto', 'history source selection method'),
                    Widget::UNIT_STATIC => _x('Static', 'history source selection method')
                ]))->setDefault(Widget::UNIT_AUTO)
            )
            ->addField(
                (new CWidgetFieldTextBox('value_static_units'))
            )
            ->addField(
                new CWidgetFieldTextBox('description', _('Description'))
            );
    }
}

```

3. Open `views/widget.edit.php` and add the field visual components to the configuration view.

ui/modules/lesson_gauge_chart/views/widget.edit.php

```
<?php
```

```

/**
 * Gauge chart widget form view.
 *
 * @var CView $this
 * @var array $data

```

```

*/

$lefty_units = new CWidgetFieldSelectView($data['fields']['value_units']);
$lefty_static_units = (new CWidgetFieldTextBoxView($data['fields']['value_static_units']))
    ->setPlaceholder(_('value'))
    ->setWidth(ZBX_TEXTAREA_TINY_WIDTH);

(new CWidgetFormView($data))
    ->addField(
        (new CWidgetFieldMultiSelectItemView($data['fields']['itemid']))
            ->setPopupParameter('numeric', true)
    )
    ->addFieldset(
        (new CWidgetFormFieldsetCollapsibleView(_('Advanced configuration')))
            ->addField(
                new CWidgetFieldColorView($data['fields']['chart_color'])
            )
            ->addField(
                new CWidgetFieldNumericBoxView($data['fields']['value_min'])
            )
            ->addField(
                new CWidgetFieldNumericBoxView($data['fields']['value_max'])
            )
            ->addItem([
                $lefty_units->getLabel(),
                (new CFormField([
                    $lefty_units->getView()->addClass(ZBX_STYLE_FORM_INPUT_MARGIN),
                    $lefty_static_units->getView()
                ]))
            ])
            ->addField(
                new CWidgetFieldTextBoxView($data['fields']['description'])
            )
        )
    ->show();

```

Note:

The `addField()` method of the `CWidgetFormView` class takes a CSS class string as the second parameter.

- Return to the dashboard, switch to the edit mode and click on the gear icon in the widget to open the widget configuration form. The widget configuration form now contains a new expandable/collapsible section *Advanced configuration*.

- Expand the *Advanced configuration* section to see additional widget configuration fields. Note that the field *Color* has no color picker yet. This is because the color picker must be initialized with JavaScript, which will be added in the next section - *Add JavaScript to the widget*.

Edit widget
? X

Type

Name

Refresh interval

* Item

Show header

^ Advanced configuration

Color

* Min

* Max

Units

Description

Add JavaScript to the widget

In this section, you will learn how to add a gauge chart - made using JavaScript - that shows if the latest value is normal or too high/too low.

1. Create a *widget.edit.js.php* file in the *views* directory.

JavaScript will be responsible for initializing the color picker in the configuration view.

ui/modules/lesson_gauge_chart/views/widget.edit.js.php

```

<?php
use Modules\LessonGaugeChart\Widget;

?>

window.widget_lesson_gauge_chart_form = new class {

    init({color_palette}) {
        this._unit_select = document.getElementById('value_units');
        this._unit_value = document.getElementById('value_static_units');

        this._unit_select.addEventListener('change', () => this.updateForm());

        colorPalette.setThemeColors(color_palette);

        for (const colorpicker of jQuery('<? ZBX_STYLE_COLOR_PICKER ?> input')) {
            jQuery(colorpicker).colorpicker();
        }

        const overlay = overlays_stack.getById('widget_properties');

        for (const event of ['overlay.reload', 'overlay.close']) {
            overlay.$dialogue[0].addEventListener(event, () => { jQuery.colorpicker('hide'); });
        }

        this.updateForm();
    }
}

```

```

updateForm() {
    this._unit_value.disabled = this._unit_select.value == <?= Widget::UNIT_AUTO ?>;
}
};

```

2. Open `views/widget.edit.php` and add the `widget.edit.js.php` file with the JavaScript to the configuration view. To do this, use the `includeJsFile()` method. To add inline JavaScript, use the `addJavaScript()` method.

ui/modules/lesson_gauge_chart/views/widget.edit.php

```

<?php

/**
 * Gauge chart widget form view.
 *
 * @var CView $this
 * @var array $data
 */

use Modules\LessonGaugeChart\Includes\WidgetForm;

$lefty_units = new CWidgetFieldSelectView($data['fields']['value_units']);
$lefty_static_units = (new CWidgetFieldTextBoxView($data['fields']['value_static_units']))
    ->setPlaceholder(_('value'))
    ->setWidth(ZBX_TEXTAREA_TINY_WIDTH);

(new CWidgetFormView($data))
    ->addField(
        (new CWidgetFieldMultiSelectItemView($data['fields']['itemid']))
        ->setPopupParameter('numeric', true)
    )
    ->addFieldset(
        (new CWidgetFormFieldsetCollapsibleView(_('Advanced configuration')))
        ->addField(
            new CWidgetFieldColorView($data['fields']['chart_color'])
        )
        ->addField(
            new CWidgetFieldNumericBoxView($data['fields']['value_min'])
        )
        ->addField(
            new CWidgetFieldNumericBoxView($data['fields']['value_max'])
        )
        ->addItem([
            $lefty_units->getLabel(),
            (new CFormField([
                $lefty_units->getView()->addClass(ZBX_STYLE_FORM_INPUT_MARGIN),
                $lefty_static_units->getView()
            ]))
        ])
        ->addField(
            new CWidgetFieldTextBoxView($data['fields']['description'])
        )
    )
    ->includeJsFile('widget.edit.js.php')
    ->addJavaScript('widget_lesson_gauge_chart_form.init('.json_encode([
        'color_palette' => WidgetForm::DEFAULT_COLOR_PALETTE
    ]), JSON_THROW_ON_ERROR).');')
    ->show();

```

3. Return to the dashboard, click on the gear icon in the widget to open the widget configuration form. Now, expand the *Advanced configuration* section to see the initialized color picker. Fill in the fields with values and select a color for the gauge chart.

Edit widget ? X

Type Show header

Name

Refresh interval

* Item

^ **Advanced configuration**

Color

* Min

* Max

Units

Description

4. Click on *Apply* in the widget configuration form. Then click on *Save changes* in the top right corner to save the dashboard.
5. Open *actions/WidgetView.php* and update the controller.

The `$this->fields_values` property now contains the values of all the *Advanced configuration* fields. Finalize the controller to enable passing the configuration and selected item value to the widget view.

ui/modules/lesson_gauge_chart/actions/WidgetView.php

```

<?php

namespace Modules\LessonGaugeChart\Actions;

use API,
    CControllerDashboardWidgetView,
    CControllerResponseData;

class WidgetView extends CControllerDashboardWidgetView {

    protected function doAction(): void {
        $db_items = API::Item()->get([
            'output' => ['itemid', 'value_type', 'name', 'units'],
            'itemids' => $this->fields_values['itemid'],
            'webitems' => true,
            'filter' => [
                'value_type' => [ITEM_VALUE_TYPE_UINT64, ITEM_VALUE_TYPE_FLOAT]
            ]
        ]);

        $history_value = null;

        if ($db_items) {
            $item = $db_items[0];

            $history = API::History()->get([
                'output' => API_OUTPUT_EXTEND,
                'itemids' => $item['itemid'],
                'history' => $item['value_type'],
                'sortfield' => 'clock',
                'sortorder' => ZBX_SORT_DOWN,
            ]);
        }
    }
}

```

```

        'limit' => 1
    ]);

    if ($history) {
        $history_value = convertUnitsRaw([
            'value' => $history[0]['value'],
            'units' => $item['units']
        ]);
    }
}

$this->setResponse(new CControllerResponseData([
    'name' => $this->getInput('name', $this->widget->getName()),
    'history' => $history_value,
    'fields_values' => $this->fields_values,
    'user' => [
        'debug_mode' => $this->getDebugMode()
    ]
]));
}
}
}

```

6. Open and modify `views/widget.view.php`.

You need to create a container for the gauge chart, which you will draw in the next steps, and a container for the description.

To pass values to JavaScript as a JSON object, use the `setVar()` method.

ui/modules/lesson_gauge_chart/views/widget.view.php

```

<?php

/**
 * Gauge chart widget view.
 *
 * @var CView $this
 * @var array $data
 */

(new CWidgetView($data))
    ->addItem([
        (new CDiv())->addClass('chart'),
        $data['fields_values']['description']
        ? (new CDiv($data['fields_values']['description'])->addClass('description'))
        : null
    ])
    ->setVar('history', $data['history'])
    ->setVar('fields_values', $data['fields_values'])
    ->show();

```

7. Create a new directory `assets` in the `lesson_gauge_chart` directory. This directory will be used for storing JavaScript, CSS, and potentially any other assets, such as fonts or images.

8. For widget view JavaScript, create a directory `js` in the `assets` directory.

9. Create a `class.widget.js` file in the `assets/js` directory.

This JavaScript widget class will extend the base JavaScript class of all dashboard widgets - `CWidget`.

The dashboard relies on a correct implementation of a widget and communicates any relevant information to the widget through calling the respective JavaScript methods. The dashboard also expects the widget to generate events when some interaction occurs. Thus, the `CWidget` class contains a set of methods with the default implementation of widget behavior, which can be customized by extending the class.

In this case, some customization is necessary, therefore custom logic will be implemented for the following widget behavior:

- widget initialization that is responsible for defining the initial state of the widget (see the `onInitialize()` method);

- displaying widget contents (that is, drawing the gauge chart) if the widget update process has been successful and without errors (see the *processUpdateResponse(response)* method and the related *_resizeChart()* and *_updatedChart()* methods)
- resizing the widget (see the *onResize()* method and the related *_resizeChart()* method)

For other aspects of the gauge chart widget, the default implementation for widget behavior will be used. To learn more about the JavaScript methods of the *CWidget* class, see: [JavaScript](#).

Since this JavaScript is required for the widget view, it should be loaded with the dashboard page. To enable JavaScript loading, you will need to update the *assets/js* and *js_class* parameters in the **manifest.json** file as shown in step 10.

ui/modules/lesson_gauge_chart/assets/js/class.widget.js

```
class WidgetLessonGaugeChart extends CWidget {

    static UNIT_AUTO = 0;
    static UNIT_STATIC = 1;

    onInitialize() {
        super.onInitialize();

        this._refresh_frame = null;
        this._chart_container = null;
        this._canvas = null;
        this._chart_color = null;
        this._min = null;
        this._max = null;
        this._value = null;
        this._last_value = null;
        this._units = '';
    }

    processUpdateResponse(response) {
        if (response.history === null) {
            this._value = null;
            this._units = '';
        }
        else {
            this._value = Number(response.history.value);
            this._units = response.fields_values.value_units == WidgetLessonGaugeChart.UNIT_AUTO
                ? response.history.units
                : response.fields_values.value_static_units;
        }

        this._chart_color = response.fields_values.chart_color;
        this._min = Number(response.fields_values.value_min);
        this._max = Number(response.fields_values.value_max);

        super.processUpdateResponse(response);
    }

    setContents(response) {
        if (this._canvas === null) {
            super.setContents(response);

            this._chart_container = this._body.querySelector('.chart');
            this._chart_container.style.height =
                `${this._getContentsSize().height - this._body.querySelector('.description').clientHeight}`;
            this._canvas = document.createElement('canvas');

            this._chart_container.appendChild(this._canvas);

            this._resizeChart();
        }

        this._updatedChart();
    }
}
```



```

}

onResize() {
  super.onResize();

  if (this._state === WIDGET_STATE_ACTIVE) {
    this._resizeChart();
  }
}

_resizeChart() {
  const ctx = this._canvas.getContext('2d');
  const dpr = window.devicePixelRatio;

  this._canvas.style.display = 'none';
  const size = Math.min(this._chart_container.offsetWidth, this._chart_container.offsetHeight);
  this._canvas.style.display = '';

  this._canvas.width = size * dpr;
  this._canvas.height = size * dpr;

  ctx.scale(dpr, dpr);

  this._canvas.style.width = `${size}px`;
  this._canvas.style.height = `${size}px`;

  this._refresh_frame = null;

  this._updatedChart();
}

_updatedChart() {
  if (this._last_value === null) {
    this._last_value = this._min;
  }

  const start_time = Date.now();
  const end_time = start_time + 400;

  const animate = () => {
    const time = Date.now();

    if (time <= end_time) {
      const progress = (time - start_time) / (end_time - start_time);
      const smooth_progress = 0.5 + Math.sin(Math.PI * (progress - 0.5)) / 2;
      let value = this._value !== null ? this._value : this._min;
      value = (this._last_value + (value - this._last_value) * smooth_progress - this._min) / (this._value - this._min);

      const ctx = this._canvas.getContext('2d');
      const size = this._canvas.width;
      const char_weight = size / 12;
      const char_shadow = 3;
      const char_x = size / 2;
      const char_y = size / 2;
      const char_radius = (size - char_weight) / 2 - char_shadow;

      const font_ratio = 32 / 100;

      ctx.clearRect(0, 0, size, size);

      ctx.beginPath();
      ctx.shadowBlur = char_shadow;

```

```

    ctx.shadowColor = '#bbb';
    ctx.strokeStyle = '#eee';
    ctx.lineWidth = char_weight;
    ctx.lineCap = 'round';
    ctx.arc(char_x, char_y, char_radius, Math.PI * 0.749, Math.PI * 2.251, false);
    ctx.stroke();

    ctx.beginPath();
    ctx.strokeStyle = `#${this._chart_color}`;
    ctx.lineWidth = char_weight - 2;
    ctx.lineCap = 'round';
    ctx.arc(char_x, char_y, char_radius, Math.PI * 0.75,
        Math.PI * (0.75 + (1.5 * Math.min(1, Math.max(0, value))))), false
    );
    ctx.stroke();

    ctx.shadowBlur = 2;
    ctx.fillStyle = '#1f2c33';
    ctx.font = `${(char_radius * font_ratio)|0}px Arial`;
    ctx.textAlign = 'center';
    ctx.textBaseline = 'middle';
    ctx.fillText(`${this._value !== null ? this._value : t('No data')}${this._units}`,
        char_x, char_y, size - char_shadow * 4 - char_weight * 2
    );

    ctx.fillStyle = '#768d99';
    ctx.font = `${(char_radius * font_ratio * .5)|0}px Arial`;
    ctx.textBaseline = 'top';

    ctx.textAlign = 'left';
    ctx.fillText(`${this._min}${this._min !== '' ? this._units : ''}`,
        char_weight * .75, size - char_weight * 1.25, size / 2 - char_weight
    );

    ctx.textAlign = 'right';
    ctx.fillText(`${this._max}${this._max !== '' ? this._units : ''}`,
        size - char_weight * .75, size - char_weight * 1.25, size / 2 - char_weight
    );

    requestAnimationFrame(animate);
  }
  else {
    this._last_value = this._value;
  }
};

requestAnimationFrame(animate);
}
}

```

10. Open *manifest.json* and add:

- file name (*class.widget.js*) to the array in the *assets/js* section;
- class name (*WidgetLessonGaugeChart*) to the *js_class* parameter in the *widget* section.

The *WidgetLessonGaugeChart* class will now be automatically loaded with the dashboard.

ui/modules/lesson_gauge_chart/manifest.json

```

{
  "manifest_version": 2.0,
  "id": "lesson_gauge_chart",
  "type": "widget",
  "name": "Gauge chart",
  "namespace": "LessonGaugeChart",

```

```

"version": "1.0",
"author": "Zabbix",
"actions": {
  "widget.lesson_gauge_chart.view": {
    "class": "WidgetView"
  }
},
"widget": {
  "js_class": "WidgetLessonGaugeChart"
},
"assets": {
  "js": ["class.widget.js"]
}
}

```

Add CSS styles to the widget

In this section you will learn how to add custom CSS styles to make the widget look more appealing.

1. For widget styles, create a new directory `css` in the `assets` directory.
2. Create a `widget.css` file in the `assets/css` directory. To style widget elements, use the selector `div.dashboard-widget-{widget id}`. To configure CSS for the whole widget, use the selector `form.dashboard-widget-{widget id}`

ui/modules/lesson_gauge_chart/assets/css/widget.css

```

div.dashboard-widget-lesson_gauge_chart {
  display: grid;
  grid-template-rows: 1fr;
  padding: 0;
}

div.dashboard-widget-lesson_gauge_chart .chart {
  display: grid;
  align-items: center;
  justify-items: center;
}

div.dashboard-widget-lesson_gauge_chart .chart canvas {
  background: white;
}

div.dashboard-widget-lesson_gauge_chart .description {
  padding-bottom: 8px;
  font-size: 1.750em;
  line-height: 1.2;
  text-align: center;
}

.dashboard-grid-widget-hidden-header div.dashboard-widget-lesson_gauge_chart .chart {
  margin-top: 8px;
}

```

3. Open `manifest.json` and add the CSS file name (`widget.css`) to the array in the `assets/css` section. This will allow the CSS styles defined in `widget.css` to load with the dashboard page.

ui/modules/lesson_gauge_chart/manifest.json

```

{
  "manifest_version": 2.0,
  "id": "lesson_gauge_chart",
  "type": "widget",
  "name": "Gauge chart",
  "namespace": "LessonGaugeChart",
  "version": "1.0",
  "author": "Zabbix",
  "actions": {

```

```

    "widget.lesson_gauge_chart.view": {
      "class": "WidgetView"
    }
  },
  "widget": {
    "js_class": "WidgetLessonGaugeChart"
  },
  "assets": {
    "css": ["widget.css"],
    "js": ["class.widget.js"]
  }
}
}

```

4. Refresh the dashboard page to see the finished version of the widget.

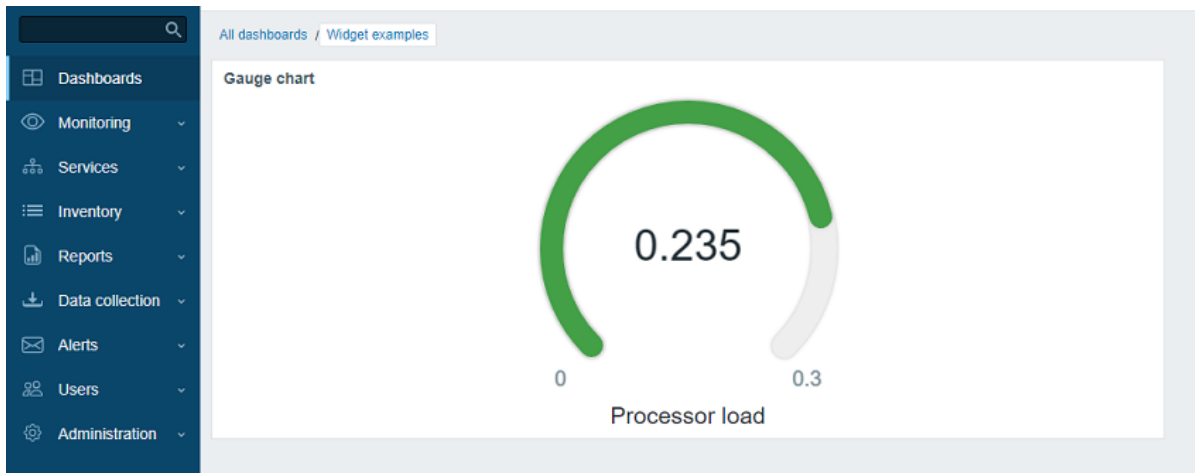

Examples

This section provides files of sample modules and widgets, which you can use as a base for your custom modules.

To use a module:

1. Download the ZIP archive.
2. Unpack the content into a separate directory inside the *modules* directory of your Zabbix frontend installation (for example, *zabbix/ui/modules*).
3. Register the module in Zabbix frontend.

Module example

- When creating a host group, grant read permissions to configured user groups - [hg_auto_perm.zip](#)

Widget examples

- Minimal widget - [widget_min.zip](#)
- "Hello, world" widget using CSS only - [hello_world_css.zip](#)
- "Hello, world" widget using JavaScript only - [hello_world_js.zip](#)
- "Hello, world" widget using PHP - [hello_world_php.zip](#)

Note:

You can also use [Zabbix native widgets](#) as examples.

Plugins

Overview Custom loadable plugins extend Zabbix agent 2 functionality. They are compiled separately, but use a package shared with Zabbix agent 2.

Each plugin is a *Go* package that defines the structure and implements one or several plugin interfaces (*Exporter*, *Configurator*, *Runner*).

Jump to:

- [Write your first plugin](#)
- [Plugin interfaces](#)

See also:

- [Example plugin for Zabbix agent 2](#)

Connection diagram Zabbix agent 2 connects bidirectionally to the plugins using UNIX sockets on Linux and Named Pipes on Windows.

The connection diagram below illustrates the communication process between Zabbix agent 2 and a loadable plugin and the metrics collection process.

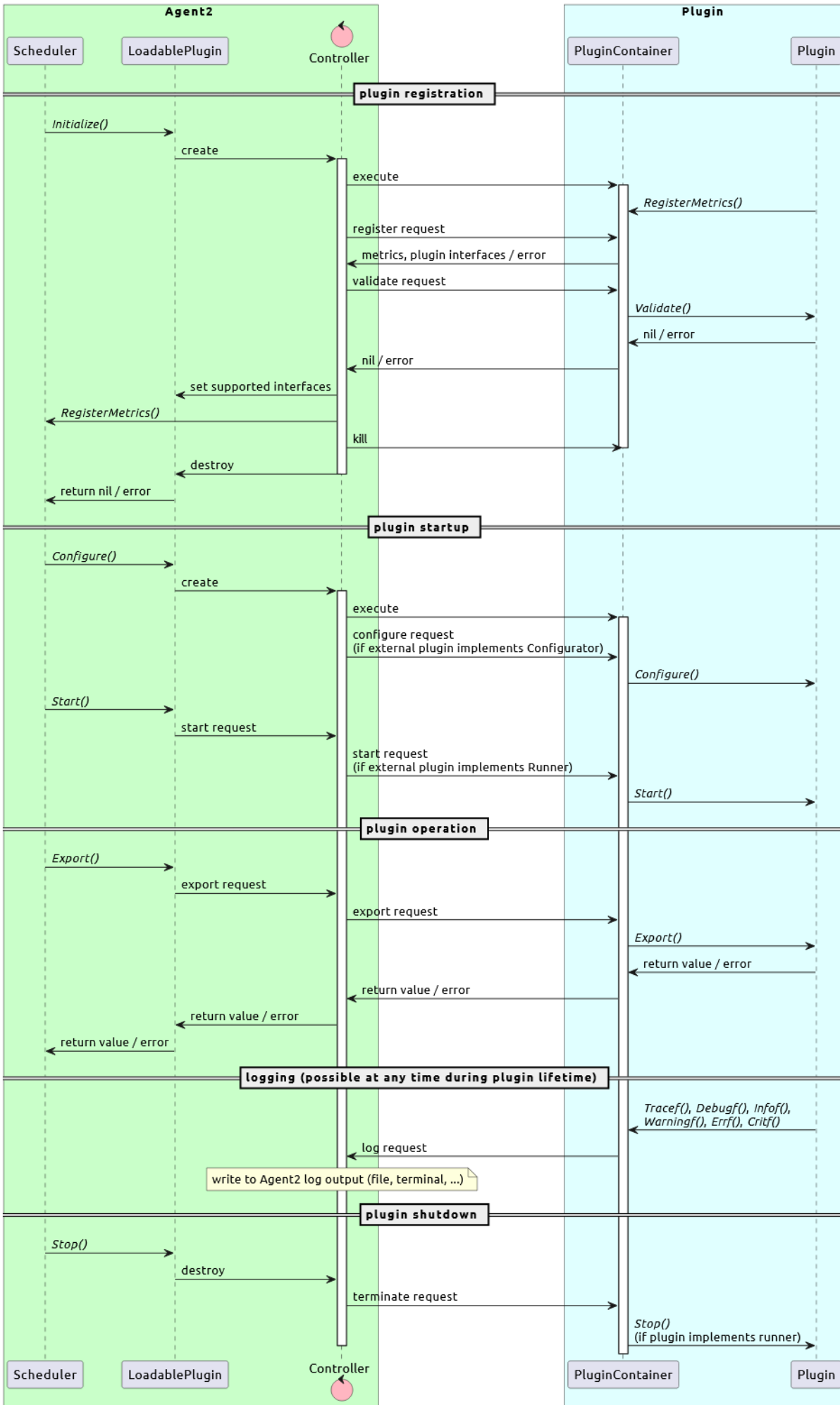

Examples

You can use several empty examples as well as existing loadable plugins supplied by Zabbix as a reference:

- [Example plugin for Zabbix agent 2](#)
- [MongoDB plugin](#)
- [PostgreSQL plugin](#)

Create a plugin (tutorial)

This is a step-by-step tutorial to create a simple loadable plugin for Zabbix agent 2.

Note:

Feel free to use our [example repository](#) as a template or guide for creating your own plugins.

What you'll create During this tutorial, you will add a new loadable plugin **MyIP**. The plugin will implement 1 metric called **myip**, which returns the external IP address of the host where Zabbix agent 2 is running.

Part 1: Writing the Go code In this section you will learn how to write the plugin that adds a new metric to Zabbix agent 2.

1. Create a new directory *myip* in */usr/local/zabbix/go/plugins/*.
2. Create the file *main.go* inside *myip* directory and define the name of your Go package.

/usr/local/zabbix/go/plugins/myip/main.go

```
package main
```

Note:

Keep the file open to add more lines as described in the next steps.

3. Specify the packages to import.
These are the packages that support the plugin.

/usr/local/zabbix/go/plugins/myip/main.go

```
package main

import (
    "fmt"
    "io/ioutil"
    "net/http"
    "git.zabbix.com/ap/plugin-support/plugin/container"
    "git.zabbix.com/ap/plugin-support/plugin"
)
```

4. Define the plugin structure.
Embed the *plugin.Base* structure to gain access to the standard plugin functionality.

/usr/local/zabbix/go/plugins/myip/main.go

```
package main

import (
    "fmt"
    "io/ioutil"
    "net/http"
    "git.zabbix.com/ap/plugin-support/plugin/container"
    "git.zabbix.com/ap/plugin-support/plugin"
)

type Plugin struct {
```

```
    plugin.Base
}
```

```
var impl Plugin
```

5. Implement plugin interface `Export`.

The `Export` interface performs a poll and returns a value.

```
/usr/local/zabbix/go/plugins/myip/main.go
```

```
package main
```

```
import (
    "fmt"
    "io/ioutil"
    "net/http"
    "git.zabbix.com/ap/plugin-support/plugin/container"
    "git.zabbix.com/ap/plugin-support/plugin"
)
```

```
type Plugin struct {
    plugin.Base
}
```

```
var impl Plugin
```

```
func (p *Plugin) Export(key string, params []string, ctx plugin.ContextProvider) (result interface{}, err
```

6. Add logging.

Log messages will appear in the Zabbix agent 2 log. You can use one of the logging functions available to plugins: `Critf()`, `Errf()`, `Infof()`, `Warningf()`, `Debugf()`, `Tracef()`.

```
/usr/local/zabbix/go/plugins/myip/main.go
```

```
package main
```

```
import (
    "fmt"
    "io/ioutil"
    "net/http"
    "git.zabbix.com/ap/plugin-support/plugin/container"
    "git.zabbix.com/ap/plugin-support/plugin"
)
```

```
type Plugin struct {
    plugin.Base
}
```

```
var impl Plugin
```

```
func (p *Plugin) Export(key string, params []string, ctx plugin.ContextProvider) (result interface{}, err
    p.Infof("received request to handle %s key with %d parameters", key, len(params))
}
```

7. Implement the core plugin logic.

This logic fetches the response from the specified URL and reads it, then returns the IP address as a response and closes the request.

In case of an error when executing the GET request or reading a response, the error is returned instead.

```
/usr/local/zabbix/go/plugins/myip/main.go
```

```
package main
```

```
import (
    "fmt"
    "io/ioutil"
```



```

    "net/http"
    "git.zabbix.com/ap/plugin-support/plugin/container"
    "git.zabbix.com/ap/plugin-support/plugin"
)

type Plugin struct {
    plugin.Base
}

var impl Plugin

func (p *Plugin) Export(key string, params []string, ctx plugin.ContextProvider) (result interface{}, err
p.Infof("received request to handle %s key with %d parameters", key, len(params))
resp, err := http.Get("https://api.ipify.org")
if err != nil {
    return nil, err
}

defer resp.Body.Close()

body, err := ioutil.ReadAll(resp.Body)
if err != nil {
    return nil, err
}

return string(body), nil
}

```

8. Register the metric.

Zabbix agent 2 initiates running *init()* function upon startup. This function will call *plugin.RegisterMetrics(structure, plugin name, metric name, description)* method to get the plugin data.

The *plugin.RegisterMetrics* method parameter description:

- **structure** - a pointer to plugin implementation; grants access to the plugin structure, including list of available plugin interfaces (for example, *&impl*).
- **name** - plugin name; must be unique (for example, *"Myip"*).
- **metric name** - metric name (for example, *"myip"*). This is the item key used to gather data from a plugin.
- **description** - metric description; must start with a capital letter and end with a period (for example, *"Return the external IP address of the host where agent is running."*).

Note:

To register several metrics, repeat the parameters **metric name** and **description** for each metric.

For example: `plugin.RegisterMetrics(&impl, "Myip", "metric.one", "Metric one description.", "metric.two", "Metric two description.")`

/usr/local/zabbix/go/plugins/myip/main.go

```

package main

import (
    "fmt"
    "io/ioutil"
    "net/http"
    "git.zabbix.com/ap/plugin-support/plugin/container"
    "git.zabbix.com/ap/plugin-support/plugin"
)

type Plugin struct {
    plugin.Base
}

var impl Plugin

```

```

func (p *Plugin) Export(key string, params []string, ctx plugin.ContextProvider) (result interface{}, err
p.Infof("received request to handle %s key with %d parameters", key, len(params))
resp, err := http.Get("https://api.ipify.org")
if err != nil {
    return nil, err
}

defer resp.Body.Close()

body, err := ioutil.ReadAll(resp.Body)
if err != nil {
    return nil, err
}

return string(body), nil
}

func init() {
    plugin.RegisterMetrics(&impl, "Myip", "myip", "Return the external IP address of the host where agent
}

```

- Define the *main()* function, which will create a new plugin handler instance, assign it to be used for logging by the plugin and then execute the plugin handler.

Attention:

Defining the *main()* function is mandatory.

/usr/local/zabbix/go/plugins/myip/main.go

```

package main

import (
    "fmt"
    "io/ioutil"
    "net/http"
    "git.zabbix.com/ap/plugin-support/plugin/container"
    "git.zabbix.com/ap/plugin-support/plugin"
)

type Plugin struct {
    plugin.Base
}

var impl Plugin

func (p *Plugin) Export(key string, params []string, ctx plugin.ContextProvider) (result interface{}, err
p.Infof("received request to handle %s key with %d parameters", key, len(params))
resp, err := http.Get("https://api.ipify.org")
if err != nil {
    return nil, err
}

defer resp.Body.Close()

body, err := ioutil.ReadAll(resp.Body)
if err != nil {
    return nil, err
}

return string(body), nil
}

func init() {

```

```

    plugin.RegisterMetrics(&impl, "Myip", "myip", "Return the external IP address of the host where agent
}

func main() {
    h, err := container.NewHandler(impl.Name())
    if err != nil {
        panic(fmt.Sprintf("failed to create plugin handler %s", err.Error()))
    }
    impl.Logger = &h

    err = h.Execute()
    if err != nil {
        panic(fmt.Sprintf("failed to execute plugin handler %s", err.Error()))
    }
}
}

```

Part 2: Building the plugin In this section you will learn how to compile the plugin.

1. To create Go files for dependency handling and download the dependencies automatically execute this bash script from the CLI.

```

go mod init myip
GOPROXY=direct go get git.zabbix.com/ap/plugin-support/plugin@branchname
go mod tidy
go build

```

Make sure to specify the correct branch name, i.e. replace branchname (see Line 2) with one of the following:

- release/* - for the stable release branch, where "*" is the release version (i.e. 7.4)
- master - for the master branch
- <commit hash> - for the specific commit version (use the specific commit hash)

The output should be similar to this:

```

go: creating new go.mod: module myip
go: to add module requirements and sums:
go mod tidy
go: finding module for package git.zabbix.com/ap/plugin-support/plugin/container
go: finding module for package git.zabbix.com/ap/plugin-support/plugin
go: found git.zabbix.com/ap/plugin-support/plugin in git.zabbix.com/ap/plugin-support v0.0.0-2022060810021
go: found git.zabbix.com/ap/plugin-support/plugin/container in git.zabbix.com/ap/plugin-support v0.0.0-202

```

2. Create an executable *myip* for the loadable plugin.
3. Specify the path to the plugin configuration file in the *Plugins.Myip.System.Path* parameter of Zabbix agent 2 configuration file.

Attention:

Plugin name in the configuration parameter name (*Myip* in this tutorial) must match the plugin name defined in the *plugin.RegisterMetrics()* function.

```

echo 'Plugins.Myip.System.Path=/usr/local/zabbix/go/plugins/myip/myip' > /etc/zabbix_agent2.d/plugins.d/my

```

4. Test the metric:

```

zabbix_agent2 -t myip

```

The response should contain an external IP address of your host.

Note:

In case of an error, check whether the user *zabbix* has permissions to access */usr/local/zabbix/go/plugins/myip* directory.

Plugin interfaces

This section describes available plugin interfaces.

plugin.Exporter *Exporter* is the simplest interface that performs a poll and returns a value (values), nothing, or error. It accepts a prepared item key, parameters, and context. Access to all other plugin interfaces is exclusive and no method can be called if a plugin is already performing a task. Also, there is a limit of 100 maximum concurrent *Export()* calls per plugin, which can be reduced according to the requirements for each plugin.

plugin.Configurator *Configurator* interface provides plugin configuration parameters from Zabbix agent 2 configuration files.

plugin.Runner *Runner* interface provides the means for performing initialization when a plugin is started (activated) and deinitialization when a plugin is stopped (deactivated). For example, a plugin can start/stop some background *goroutine* by implementing the Runner interface.

Changes to extension development

This page lists all changes to developing custom Zabbix extensions.

Changes from 7.0 to 7.2

Changes in 7.2

Zabbix manpages

These are Zabbix manpages for Zabbix processes.

zabbix_agent2

Section: Maintenance Commands (8)

Updated: 2019-01-29

[Index](#) [Return to Main Contents](#)

NAME

zabbix_agent2 - Zabbix agent 2

SYNOPSIS

```
zabbix_agent2 [-c config-file]  
zabbix_agent2 [-c config-file] [-v] -p  
zabbix_agent2 [-c config-file] [-v] -t item-key  
zabbix_agent2 [-c config-file] -R runtime-option  
zabbix_agent2 [-c config-file] -T  
zabbix_agent2 -h  
zabbix_agent2 -V
```

DESCRIPTION

zabbix_agent2 is an application for monitoring parameters of various services.

OPTIONS

-c, --config *config-file*

Use the alternate *config-file* instead of the default one.

-R, --runtime-control *runtime-option*

Perform administrative functions according to *runtime-option*.

Runtime control options: **userparameter_reload**

Reload user parameters from the configuration file

log_level_increase

Increase log level

log_level_decrease

Decrease log level

help

List available runtime control options

metrics

List available metrics

version

Display version

-p, --print

Print known items and exit. For each item either generic defaults are used, or specific defaults for testing are supplied. These defaults are listed in square brackets as item key parameters. Returned values are enclosed in square brackets and prefixed with the type of the returned value, separated by a pipe character. For user parameters type is always **t**, as the agent can not determine all possible return values. Items, displayed as working, are not guaranteed to work from the Zabbix server or `zabbix_get` when querying a running agent daemon as permissions or environment may be different. Returned value types are:

d

Number with a decimal part.

m

Not supported. This could be caused by querying an item that only works in the active mode like a log monitoring item or an item that requires multiple collected values. Permission issues or incorrect user parameters could also result in the not supported state.

s

Text. Maximum length not limited.

t

Text. Same as **s**.

u

Unsigned integer.

-t, --test *item-key*

Test single item and exit. See **--print** for output description.

-v, --verbose

Enable verbose output when test item or print known items.

-T, --test-config

Validate configuration file and exit.

-h, --help

Display this help and exit.

-V, --version

Output version information and exit.

FILES

/usr/local/etc/zabbix_agent2.conf

Default location of Zabbix agent 2 configuration file (if not modified during compile time).

SEE ALSO

Documentation <https://www.zabbix.com/manuals>

zabbix_agentd(8), **zabbix_get**(8), **zabbix_js**(8), **zabbix_proxy**(8), **zabbix_sender**(8), **zabbix_server**(8)

Index

NAME

SYNOPSIS

DESCRIPTION

OPTIONS

FILES

SEE ALSO

AUTHOR

This document was created on: 14:07:57 GMT, November 22, 2021

zabbix_agentd

Section: Maintenance Commands (8)

Updated: 2019-01-29

[Index Return to Main Contents](#)

NAME

zabbix_agentd - Zabbix agent daemon

SYNOPSIS

zabbix_agentd [-c *config-file*]

zabbix_agentd [-c *config-file*] -p

zabbix_agentd [-c *config-file*] -t *item-key*

zabbix_agentd [-c *config-file*] -R *runtime-option*

zabbix_agentd [-c *config-file*] -T

zabbix_agentd -h

zabbix_agentd -V

DESCRIPTION

zabbix_agentd is a daemon for monitoring various server parameters.

OPTIONS

-c, --config *config-file*

Use the alternate *config-file* instead of the default one.

-f, --foreground

Run Zabbix agent in foreground.

-R, --runtime-control *runtime-option*

Perform administrative functions according to *runtime-option*.

Runtime control options `userparameter_reload`

Reload user parameters from the configuration file

log_level_increase[=*target*]

Increase log level, affects all processes if target is not specified

log_level_decrease[=*target*]

Decrease log level, affects all processes if target is not specified

Log level control targets

process-type

All processes of specified type (active checks, collector, listener)

process-type,N

Process type and number (e.g., listener,3)

pid

Process identifier, up to 65535. For larger values specify target as "process-type,N"

-p, --print

Print known items and exit. For each item either generic defaults are used, or specific defaults for testing are supplied. These defaults are listed in square brackets as item key parameters. Returned values are enclosed in square brackets and prefixed with the type of the returned value, separated by a pipe character. For user parameters type is always **t**, as the agent can not determine all possible return values. Items, displayed as working, are not guaranteed to work from the Zabbix server or `zabbix_get` when querying a running agent daemon as permissions or environment may be different. Returned value types are:

d

Number with a decimal part.

m

Not supported. This could be caused by querying an item that only works in the active mode like a log monitoring item or an item that requires multiple collected values. Permission issues or incorrect user parameters could also result in the not supported state.

s

Text. Maximum length not limited.

t

Text. Same as **s**.

u

Unsigned integer.

-t, --test *item-key*

Test single item and exit. See **--print** for output description.

-T, --test-config

Validate configuration file and exit.

-h, --help

Display this help and exit.

-V, --version

Output version information and exit.

FILES

/usr/local/etc/zabbix_agentd.conf

Default location of Zabbix agent configuration file (if not modified during compile time).

SEE ALSO

Documentation <https://www.zabbix.com/manuals>

[zabbix_agent2\(8\)](#), [zabbix_get\(1\)](#), [zabbix_js\(1\)](#), [zabbix_proxy\(8\)](#), [zabbix_sender\(1\)](#), [zabbix_server\(8\)](#)

Index

NAME

SYNOPSIS

DESCRIPTION

OPTIONS

FILES

SEE ALSO

AUTHOR

This document was created on: 20:50:13 GMT, November 22, 2021

zabbix_get

Section: User Commands (1)

Updated: 2021-06-01

[Index Return to Main Contents](#)

NAME

zabbix_get - Zabbix get utility

SYNOPSIS

zabbix_get -s *host-name-or-IP* [-p *port-number*] [-I *IP-address*] [-t *timeout*] -k *item-key*

zabbix_get -s *host-name-or-IP* [-p *port-number*] [-I *IP-address*] [-t *timeout*] --tls-connect **cert** --tls-ca-file *CA-file* [--tls-crl-file *CRL-file*] [--tls-agent-cert-issuer *cert-issuer*] [--tls-agent-cert-subject *cert-subject*] --tls-cert-file *cert-file* --tls-key-file *key-file* [--tls-cipher13 *cipher-string*] [--tls-cipher *cipher-string*] -k *item-key*

zabbix_get -s *host-name-or-IP* [-p *port-number*] [-I *IP-address*] [-t *timeout*] --tls-connect **psk** --tls-psk-identity *PSK-identity* --tls-psk-file *PSK-file* [--tls-cipher13 *cipher-string*] [--tls-cipher *cipher-string*] -k *item-key*

zabbix_get -h

zabbix_get -V

DESCRIPTION

zabbix_get is a command line utility for getting data from Zabbix agent.

OPTIONS

-s, --host *host-name-or-IP*

Specify host name or IP address of a host.

-p, --port *port-number*

Specify port number of agent running on the host. Default is 10050.

-I, --source-address *IP-address*

Specify source IP address.

-t, --timeout *seconds*

Specify timeout. Valid range: 1-30 seconds (default: 30)

-k, --key *item-key*

Specify key of item to retrieve value for.

-P, --protocol *value*

Protocol used to communicate with agent. Values:

auto connect using JSON protocol, fallback and retry with plaintext protocol (default)

json connect using JSON protocol

plaintext connect using plaintext protocol where just item key is sent (6.4.x and older releases)

--tls-connect *value*

How to connect to agent. Values:

unencrypted

connect without encryption (default)

psk

connect using TLS and a pre-shared key

cert

connect using TLS and a certificate

--tls-ca-file *CA-file*

Full pathname of a file containing the top-level CA(s) certificates for peer certificate verification.

--tls-crl-file *CRL-file*

Full pathname of a file containing revoked certificates.

--tls-agent-cert-issuer *cert-issuer*

Allowed agent certificate issuer.

--tls-agent-cert-subject *cert-subject*

Allowed agent certificate subject.

--tls-cert-file *cert-file*

Full pathname of a file containing the certificate or certificate chain.

--tls-key-file *key-file*

Full pathname of a file containing the private key.

--tls-psk-identity *PSK-identity*

PSK-identity string.

--tls-psk-file *PSK-file*

Full pathname of a file containing the pre-shared key.

--tls-cipher13 *cipher-string*

Cipher string for OpenSSL 1.1.1 or newer for TLS 1.3. Override the default ciphersuite selection criteria. This option is not available if OpenSSL version is less than 1.1.1.

--tls-cipher *cipher-string*

GnuTLS priority string (for TLS 1.2 and up) or OpenSSL cipher string (only for TLS 1.2). Override the default ciphersuite selection criteria.

-h, --help

Display this help and exit.

-V, --version

Output version information and exit.

EXAMPLES

```
zabbix_get -s 127.0.0.1 -p 10050 -k "system.cpu.load[all,avg1]"
```

```
zabbix_get -s 127.0.0.1 -p 10050 -k "system.cpu.load[all,avg1]" --tls-connect cert --tls-ca-file /home/zabbix/zabbix_ca_file  
--tls-agent-cert-issuer "CN=Signing CA,OU=IT operations,O=Example Corp,DC=example,DC=com" --tls-agent-cert-  
subject "CN=server1,OU=IT operations,O=Example Corp,DC=example,DC=com" --tls-cert-file /home/zabbix/zabbix_get.crt  
--tls-key-file /home/zabbix/zabbix_get.key
```

```
zabbix_get -s 127.0.0.1 -p 10050 -k "system.cpu.load[all,avg1]" --tls-connect psk --tls-psk-identity "PSK ID Zabbix agentd" --tls-psk-file /home/zabbix/zabbix_agentd.psk
```

SEE ALSO

Documentation <https://www.zabbix.com/manuals>

[zabbix_agentd\(8\)](#), [zabbix_proxy\(8\)](#), [zabbix_sender\(1\)](#), [zabbix_server\(8\)](#), [zabbix_js\(1\)](#), [zabbix_agent2\(8\)](#), [zabbix_web_service\(8\)](#)

Index

[NAME](#)

[SYNOPSIS](#)

[DESCRIPTION](#)

[OPTIONS](#)

[EXAMPLES](#)

[SEE ALSO](#)

[AUTHOR](#)

This document was created on: 08:42:29 GMT, June 11, 2021

zabbix_js

Section: User Commands (1)

Updated: 2019-01-29

[Index Return to Main Contents](#)

NAME

zabbix_js - Zabbix JS utility

SYNOPSIS

```
zabbix_js -s script-file -p input-param [-l log-level] [-t timeout]
```

```
zabbix_js -s script-file -i input-file [-l log-level] [-t timeout]
```

```
zabbix_js -h
```

```
zabbix_js -V
```

DESCRIPTION

zabbix_js is a command line utility that can be used for embedded script testing.

OPTIONS

-s, --script *script-file*

Specify the file name of the script to execute. If '-' is specified as file name, the script will be read from stdin.

-p, --param *input-param*

Specify the input parameter.

-i, --input *input-file*

Specify the file name of the input parameter. If '-' is specified as file name, the input will be read from stdin.

-w, --webdriver *url*

Specify the webdriver URL.

-l, --loglevel *log-level*

Specify the log level.

-t, --timeout *timeout*

Specify the timeout in seconds. Valid range: 1-60 seconds (default: 10)

-h, --help

Display this help and exit.

-V, --version

Output version information and exit.

EXAMPLES

zabbix_js -s script-file.js -p example

SEE ALSO

Documentation <https://www.zabbix.com/manuals>

zabbix_agent2(8), zabbix_agentd(8), zabbix_get(1), zabbix_proxy(8), zabbix_sender(1), zabbix_server(8)

Index

NAME

SYNOPSIS

DESCRIPTION

OPTIONS

EXAMPLES

SEE ALSO

This document was created on: 21:23:35 GMT, March 18, 2020

zabbix_proxy

Section: Maintenance Commands (8)

Updated: 2020-09-04

[Index Return to Main Contents](#)

NAME

zabbix_proxy - Zabbix proxy daemon

SYNOPSIS

zabbix_proxy [-c *config-file*]

zabbix_proxy [-c *config-file*] **-R** *runtime-option*

zabbix_proxy [-c *config-file*] **-T**

zabbix_proxy **-h**

zabbix_proxy **-V**

DESCRIPTION

zabbix_proxy is a daemon that collects monitoring data from devices and sends it to Zabbix server.

OPTIONS

-c, --config *config-file*

Use the alternate *config-file* instead of the default one.

-f, --foreground

Run Zabbix proxy in foreground.

-R, --runtime-control *runtime-option*

Perform administrative functions according to *runtime-option*.

Runtime control options

config_cache_reload

Reload configuration cache. Ignored if cache is being currently loaded. Active Zabbix proxy will connect to the Zabbix server and request configuration data. Default configuration file (unless **-c** option is specified) will be used to find PID file and signal will be sent to process, listed in PID file.

snmp_cache_reload

Reload SNMP cache.

housekeeper_execute

Execute the housekeeper. Ignored if housekeeper is being currently executed.

diaginfo[=*section*]

Log internal diagnostic information of the specified section. Section can be *historycache*, *preprocessing*, *locks*. By default diagnostic information of all sections is logged.

log_level_increase[=*target*]

Increase log level, affects all processes if target is not specified.

log_level_decrease[=*target*]

Decrease log level, affects all processes if target is not specified.

Log level control targets

process-type

All processes of specified type (availability manager, browser poller, configuration syncer, data sender, discovery manager, history syncer, housekeeper, http poller, icmp pinger, ipmi manager, ipmi poller, java poller, odbc poller, poller, agent poller, http agent poller, snmp poller, preprocessing manager, self-monitoring, snmp trapper, task manager, trapper, unreachable poller, vmware collector)

process-type,N

Process type and number (e.g., poller,3)

pid

Process identifier, up to 65535. For larger values specify target as "process-type,N"

Profiling control targets

process-type

All processes of specified type (configuration syncer, data sender, discovery manager, history syncer, housekeeper, http poller, preprocessing manager, icmp pinger, ipmi manager, ipmi poller, java poller, poller, agent poller, http agent poller, snmp poller, self-monitoring, snmp trapper, task manager, trapper, unreachable poller, vmware collector, history poller, availability manager, odbc poller)

process-type,N

Process type and number (e.g., history syncer,1)

pid

Process identifier, up to 65535. For larger values specify target as "process-type,N"

scope

Profiling scope (rwlock, mutex, processing) can be used with process type (e.g., history syncer,1,processing)

-T, --test-config

Validate configuration file and exit.

-h, --help

Display this help and exit.

-V, --version

Output version information and exit.

FILES

/usr/local/etc/zabbix_proxy.conf

Default location of Zabbix proxy configuration file (if not modified during compile time).

SEE ALSO

Documentation <https://www.zabbix.com/manuals>

zabbix_agentd(8), **zabbix_get(1)**, **zabbix_sender(1)**, **zabbix_server(8)**, **zabbix_js(1)**, **zabbix_agent2(8)**

Index

[NAME](#)

[SYNOPSIS](#)

[DESCRIPTION](#)

[OPTIONS](#)

[FILES](#)

[SEE ALSO](#)

[AUTHOR](#)

This document was created on: 16:12:22 GMT, September 04, 2020

zabbix_sender

Section: User Commands (1)

Updated: 2021-06-01

[Index Return to Main Contents](#)

NAME

zabbix_sender - Zabbix sender utility

SYNOPSIS

zabbix_sender [-v] -z server [-p port] [-I IP-address] [-t timeout] -s host -k key -o value

zabbix_sender [-v] -z server [-p port] [-I IP-address] [-t timeout] [-s host] [-T] [-N] [-r] [-g] -i input-file

zabbix_sender [-v] -c config-file [-z server] [-p port] [-I IP-address] [-t timeout] [-s host] -k key -o value

zabbix_sender [-v] -c config-file [-z server] [-p port] [-I IP-address] [-t timeout] [-s host] [-T] [-N] [-r] [-g] -i input-file

zabbix_sender [-v] -z server [-p port] [-I IP-address] [-t timeout] -s host --tls-connect cert --tls-ca-file CA-file [--tls-crl-file CRL-file] [--tls-server-cert-issuer cert-issuer] [--tls-server-cert-subject cert-subject] --tls-cert-file cert-file --tls-key-file key-file [--tls-cipher13 cipher-string] [--tls-cipher cipher-string] -k key -o value

zabbix_sender [-v] -z server [-p port] [-I IP-address] [-t timeout] [-s host] --tls-connect cert --tls-ca-file CA-file [--tls-crl-file CRL-file] [--tls-server-cert-issuer cert-issuer] [--tls-server-cert-subject cert-subject] --tls-cert-file cert-file --tls-key-file key-file [--tls-cipher13 cipher-string] [--tls-cipher cipher-string] [-T] [-N] [-r] [-g] -i input-file

zabbix_sender [-v] -c config-file [-z server] [-p port] [-I IP-address] [-t timeout] [-s host] --tls-connect cert --tls-ca-file CA-file [--tls-crl-file CRL-file] [--tls-server-cert-issuer cert-issuer] [--tls-server-cert-subject cert-subject] --tls-cert-file cert-file

```

--tls-key-file key-file [--tls-cipher13 cipher-string] [--tls-cipher cipher-string] -k key -o value
zabbix_sender [-v] -c config-file [-z server] [-p port] [-I IP-address] [-t timeout] [-s host] --tls-connect cert --tls-ca-file CA-file
[--tls-crl-file CRL-file] [--tls-server-cert-issuer cert-issuer] [--tls-server-cert-subject cert-subject] --tls-cert-file cert-file
--tls-key-file key-file [--tls-cipher13 cipher-string] [--tls-cipher cipher-string] [-T] [-N] [-r] [-g] -i input-file
zabbix_sender [-v] -z server [-p port] [-I IP-address] [-t timeout] -s host --tls-connect psk --tls-psk-identity PSK-identity --
tls-psk-file PSK-file [--tls-cipher13 cipher-string] [--tls-cipher cipher-string] -k key -o value
zabbix_sender [-v] -z server [-p port] [-I IP-address] [-t timeout] [-s host] --tls-connect psk --tls-psk-identity PSK-identity
--tls-psk-file PSK-file [--tls-cipher13 cipher-string] [--tls-cipher cipher-string] [-T] [-N] [-r] [-g] -i input-file
zabbix_sender [-v] -c config-file [-z server] [-p port] [-I IP-address] [-t timeout] [-s host] --tls-connect psk --tls-psk-identity
PSK-identity --tls-psk-file PSK-file [--tls-cipher13 cipher-string] [--tls-cipher cipher-string] -k key -o value
zabbix_sender [-v] -c config-file [-z server] [-p port] [-I IP-address] [-t timeout] [-s host] --tls-connect psk --tls-psk-identity
PSK-identity --tls-psk-file PSK-file [--tls-cipher13 cipher-string] [--tls-cipher cipher-string] [-T] [-N] [-r] [-g] -i input-file
zabbix_sender -h
zabbix_sender -V

```

DESCRIPTION

zabbix_sender is a command line utility for sending monitoring data to Zabbix server or proxy. On the Zabbix server an item of type **Zabbix trapper** should be created with corresponding key. Note that incoming values will only be accepted from hosts specified in **Allowed hosts** field for this item.

OPTIONS

-c, --config *config-file*

Use *config-file*. **Zabbix sender** reads server details from the agentd configuration file. By default **Zabbix sender** does not read any configuration file. Only parameters **Hostname**, **ServerActive**, **SourceIP**, **TLSCONNECT**, **TLSCAFile**, **TLSCRLFile**, **TLSServerCertIssuer**, **TLSServerCertSubject**, **TLSCertFile**, **TLSKeyFile**, **TLSPSKIdentity** and **TLSPSKFile** are supported. Hostname defined through **HostnameItem** parameter will not be picked up, in this case the hostname should be specified via command line (see **-s** option). All addresses defined in the agent **ServerActive** configuration parameter are used for sending data. If sending of batch data fails to one address, the following batches are not sent to this address.

-z, --zabbix-server *server*

Hostname or IP address of Zabbix server. If a host is monitored by a proxy, proxy hostname or IP address should be used instead. When used together with **--config**, overrides the entries of **ServerActive** parameter specified in agentd configuration file.

-p, --port *port*

Specify port number of Zabbix server trapper running on the server. Default is 10051. When used together with **--config**, overrides the port entries of **ServerActive** parameter specified in agentd configuration file.

-I, --source-address *IP-address*

Specify source IP address. When used together with **--config**, overrides **SourceIP** parameter specified in agentd configuration file.

-t, --timeout *seconds*

Specify timeout. Valid range: 1-300 seconds (default: 60)

-s, --host *host*

Specify host name the item belongs to (as registered in Zabbix frontend). Host IP address and DNS name will not work. When used together with **--config**, overrides **Hostname** parameter specified in agentd configuration file.

-k, --key *key*

Specify item key to send value to.

-o, --value *value*

Specify item value.

-i, --input-file *input-file*

Load values from input file. Specify **-** as **<input-file>** to read values from standard input. Each line of file contains whitespace delimited: **<hostname> <key> <value>**. Each value must be specified on its own line. Each line must contain 3 whitespace delimited entries: **<hostname> <key> <value>**, where "hostname" is the name of monitored host as registered in Zabbix frontend, "key" is target item key and "value" - the value to send. Specify **-** as **<hostname>** to use hostname from agent configuration file or from **--host** argument.

An example of a line of an input file:

```
"Linux DB3" db.connections 43
```

The value type must be correctly set in item configuration of Zabbix frontend. Zabbix sender will send up to 250 values in one connection. **Size limit** for sending values from an input file depends on the size described in Zabbix communication protocol.

Contents of the input file must be in the UTF-8 encoding. All values from the input file are sent in a sequential order top-down. Entries must be formatted using the following rules:

- Quoted and non-quoted entries are supported.
- Double-quote is the quoting character.
- Entries with whitespace must be quoted.
- Double-quote and backslash characters inside quoted entry must be escaped with a backslash.
- Escaping is not supported in non-quoted entries.
- Linefeed escape sequences (\n) are supported in quoted strings.
- Linefeed escape sequences are trimmed from the end of an entry.

-T, --with-timestamps

This option can be only used with **--input-file** option.

Each line of the input file must contain 4 whitespace delimited entries: **<hostname> <key> <timestamp> <value>**. Timestamp should be specified in Unix timestamp format. If target item has triggers referencing it, all timestamps must be in an increasing order, otherwise event calculation will not be correct.

An example of a line of the input file:

"Linux DB3" db.connections 1429533600 43

For more details please see option **--input-file**.

If a timestamped value is sent for a host that is in a "no data" maintenance type then this value will be dropped; however, it is possible to send a timestamped value in for an expired maintenance period and it will be accepted.

-N, --with-ns

This option can be only used with **--with-timestamps** option.

Each line of the input file must contain 5 whitespace delimited entries: **<hostname> <key> <timestamp> <ns> <value>**.

An example of a line of the input file:

"Linux DB3" db.connections 1429533600 7402561 43

For more details please see option **--input-file**.

-r, --real-time

Send values one by one as soon as they are received. This can be used when reading from standard input.

-g, --group

Group values by hosts and send to each host in a separate batch.

--tls-connect *value*

How to connect to server or proxy. Values:

unencrypted

connect without encryption (default)

psk

connect using TLS and a pre-shared key

cert

connect using TLS and a certificate

--tls-ca-file *CA-file*

Full pathname of a file containing the top-level CA(s) certificates for peer certificate verification.

--tls-crl-file *CRL-file*

Full pathname of a file containing revoked certificates.

--tls-server-cert-issuer *cert-issuer*

Allowed server certificate issuer.

--tls-server-cert-subject *cert-subject*

Allowed server certificate subject.

--tls-cert-file *cert-file*

Full pathname of a file containing the certificate or certificate chain.

--tls-key-file *key-file*

Full pathname of a file containing the private key.

--tls-psk-identity *PSK-identity*

PSK-identity string.

--tls-psk-file *PSK-file*

Full pathname of a file containing the pre-shared key.

--tls-cipher13 *cipher-string*

Cipher string for OpenSSL 1.1.1 or newer for TLS 1.3. Override the default ciphersuite selection criteria. This option is not available if OpenSSL version is less than 1.1.1.

--tls-cipher *cipher-string*

GnuTLS priority string (for TLS 1.2 and up) or OpenSSL cipher string (only for TLS 1.2). Override the default ciphersuite selection criteria.

-v, --verbose

Verbose mode, **-vv** for more details.

-h, --help

Display this help and exit.

-V, --version

Output version information and exit.

EXIT STATUS

The exit status is 0 if the values were sent and all of them were successfully processed by server. If data was sent, but processing of at least one of the values failed, the exit status is 2. If data sending failed, the exit status is 1.

EXAMPLES

zabbix_sender -c /etc/zabbix/zabbix_agentd.conf -k mysql.queries -o 342.45

Send **342.45** as the value for **mysql.queries** item of monitored host. Use monitored host and Zabbix server defined in agent configuration file.

zabbix_sender -c /etc/zabbix/zabbix_agentd.conf -s "Monitored Host" -k mysql.queries -o 342.45

Send **342.45** as the value for **mysql.queries** item of **Monitored Host** host using Zabbix server defined in agent configuration file.

zabbix_sender -z 192.168.1.113 -i data_values.txt

Send values from file **data_values.txt** to Zabbix server with IP **192.168.1.113**. Host names and keys are defined in the file.

echo "- hw.serial.number 1287872261 SQ4321ASDF" | zabbix_sender -c /usr/local/etc/zabbix_agentd.conf -T -i -

Send a timestamped value from the commandline to Zabbix server, specified in the agent configuration file. Dash in the input data indicates that hostname also should be used from the same configuration file.

echo ""Zabbix server" trapper.item "" | zabbix_sender -z 192.168.1.113 -p 10000 -i -

Send empty value of an item to the Zabbix server with IP address **192.168.1.113** on port **10000** from the commandline. Empty values must be indicated by empty double quotes.

zabbix_sender -z 192.168.1.113 -s "Monitored Host" -k mysql.queries -o 342.45 --tls-connect cert --tls-ca-file /home/zabbix/zabbix_ca_file --tls-cert-file /home/zabbix/zabbix_agentd.crt --tls-key-file /home/zabbix/zabbix_agentd.key

Send **342.45** as the value for **mysql.queries** item in **Monitored Host** host to server with IP **192.168.1.113** using TLS with certificate.

```
zabbix_sender -z 192.168.1.113 -s "Monitored Host" -k mysql.queries -o 342.45 --tls-connect psk --tls-psk-identity "PSK ID Zabbix agentd" --tls-psk-file /home/zabbix/zabbix_agentd.psk
```

Send **342.45** as the value for **mysql.queries** item in **Monitored Host** host to server with IP **192.168.1.113** using TLS with pre-shared key (PSK).

SEE ALSO

Documentation <https://www.zabbix.com/manuals>

[zabbix_agentd\(8\)](#), [zabbix_get\(1\)](#), [zabbix_proxy\(8\)](#), [zabbix_server\(8\)](#), [zabbix_js\(1\)](#), [zabbix_agent2\(8\)](#), [zabbix_web_service\(8\)](#)

Index

[NAME](#)

[SYNOPSIS](#)

[DESCRIPTION](#)

[OPTIONS](#)

[EXIT STATUS](#)

[EXAMPLES](#)

[SEE ALSO](#)

[AUTHOR](#)

This document was created on: 08:42:39 GMT, June 11, 2021

zabbix_server

Section: Maintenance Commands (8)

Updated: 2020-09-04

[Index Return to Main Contents](#)

NAME

zabbix_server - Zabbix server daemon

SYNOPSIS

```
zabbix_server [-c config-file]  
zabbix_server [-c config-file] -R runtime-option  
zabbix_server [-c config-file] -T  
zabbix_server -h  
zabbix_server -V
```

DESCRIPTION

zabbix_server is the core daemon of Zabbix software.

OPTIONS

-c, --config *config-file*

Use the alternate *config-file* instead of the default one.

-f, --foreground

Run Zabbix server in foreground.

-R, --runtime-control *runtime-option*

Perform administrative functions according to *runtime-option*.

-T, --test-config

Validate configuration file and exit.

-h, --help

Display this help and exit.

-V, --version

Output version information and exit.

Examples of running Zabbix server with command line parameters:

```
zabbix_server -c /usr/local/etc/zabbix_server.conf
zabbix_server --help
zabbix_server -V
```

RUNTIME CONTROL

Runtime control options:

config_cache_reload

Reload configuration cache. Ignored if cache is being currently loaded. Default configuration file (unless **-c** option is specified) will be used to find PID file and signal will be sent to process, listed in PID file.

snmp_cache_reload

Reload SNMP cache, clear the SNMP properties (engine time, engine boots, engine id, credentials) for all hosts.

housekeeper_execute

Execute the housekeeper. Ignored if housekeeper is being currently executed.

trigger_housekeeper_execute

Execute the trigger housekeeper (remove problems for deleted triggers). Ignored if trigger housekeeper for services is being currently executed.

diaginfo[=*section*]

Log internal diagnostic information of the specified section. Section can be *historycache*, *preprocessing*, *alerting*, *lld*, *valuecache*, *locks*. By default diagnostic information of all sections is logged.

ha_status

Log high availability (HA) cluster status.

ha_remove_node[=*target*]

Remove the high availability (HA) node specified by its name or ID. Note that active/standby nodes cannot be removed.

ha_set_failover_delay[=*delay*]

Set high availability (HA) failover delay. Time suffixes are supported, e.g. 10s, 1m.

proxy_config_cache_reload[=*target*] Reload proxy configuration cache.

secrets_reload

Reload secrets from Vault.

service_cache_reload

Reload the service manager cache.

prof_enable[=*target*]

Enable profiling. Affects all processes if target is not specified. Enabled profiling provides details of all rwlocks/mutexes by function name.

prof_disable[=*target*]

Disable profiling. Affects all processes if target is not specified.

log_level_increase[=*target*]

Increase log level, affects all processes if target is not specified

log_level_decrease[=*target*]

Decrease log level, affects all processes if target is not specified

Log level control targets

process-type

All processes of specified type (alerter, alert manager, availability manager, browser poller, configuration syncer, configuration syncer worker, connector manager, connector worker, discovery manager, escalator, ha manager, history poller, history syncer, housekeeper, http poller, icmp pinger, internal poller, ipmi manager, ipmi poller, java poller, odbc poller, poller, agent poller, http agent poller, snmp poller, preprocessing manager, proxy group manager, proxy poller, self-monitoring, service manager, snmp trapper, task manager, timer, trapper, unreachable poller, vmware collector)

process-type,N

Process type and number (e.g., poller,3)

pid

Process identifier, up to 65535. For larger values specify target as "process-type,N"

Profiling control targets

process-type

All processes of specified type (alerter, alert manager, availability manager, browser poller, configuration syncer, configuration syncer worker, connector manager, connector worker, discovery manager, escalator, ha manager, history poller, history syncer, housekeeper, http poller, icmp pinger, internal poller, ipmi manager, ipmi poller, java poller, odbc poller, poller, agent poller, http agent poller, snmp poller, preprocessing manager, proxy group manager, proxy poller, self-monitoring, service manager, snmp trapper, task manager, timer, trapper, unreachable poller, vmware collector)

process-type,N

Process type and number (e.g., history syncer,1)

pid

Process identifier, up to 65535. For larger values specify target as "process-type,N"

scope

Profiling scope (rwlock, mutex, processing) can be used with process type (e.g., history syncer,1,processing)

FILES

/usr/local/etc/zabbix_server.conf

Default location of Zabbix server configuration file (if not modified during compile time).

SEE ALSO

Documentation <https://www.zabbix.com/manuals>

zabbix_agentd(8), **zabbix_get**(1), **zabbix_proxy**(8), **zabbix_sender**(1), **zabbix_js**(1), **zabbix_agent2**(8)

Index

NAME

SYNOPSIS

DESCRIPTION

OPTIONS

FILES

SEE ALSO

AUTHOR

zabbix_web_service

Section: Maintenance Commands (8)

Updated: 2019-01-29

[Index Return to Main Contents](#)

NAME

`zabbix_web_service` - Zabbix web service

SYNOPSIS

`zabbix_web_service [-c config-file]`

`zabbix_web_service [-c config-file] -T`

`zabbix_web_service -h`

`zabbix_web_service -V`

DESCRIPTION

`zabbix_web_service` is an application for providing web services to Zabbix components.

OPTIONS

-c, --config *config-file*

Use the alternate *config-file* instead of the default one.

-T, --test-config

Validate configuration file and exit.

-h, --help

Display this help and exit.

-V, --version

Output version information and exit.

FILES

`/usr/local/etc/zabbix_web_service.conf`

Default location of Zabbix web service configuration file (if not modified during compile time).

SEE ALSO

Documentation <https://www.zabbix.com/manuals>

[zabbix_agentd\(8\)](#), [zabbix_get\(1\)](#), [zabbix_proxy\(8\)](#), [zabbix_sender\(1\)](#), [zabbix_server\(8\)](#), [zabbix_js\(1\)](#), [zabbix_agent2\(8\)](#)

Index

[NAME](#)

[SYNOPSIS](#)

[DESCRIPTION](#)

[OPTIONS](#)

[FILES](#)

[SEE ALSO](#)

AUTHOR

This document was created on: 12:58:30 GMT, June 11, 2021